



Please read the user manual carefully before riding

Original instructions

Electric Scooter

S1

User Manual

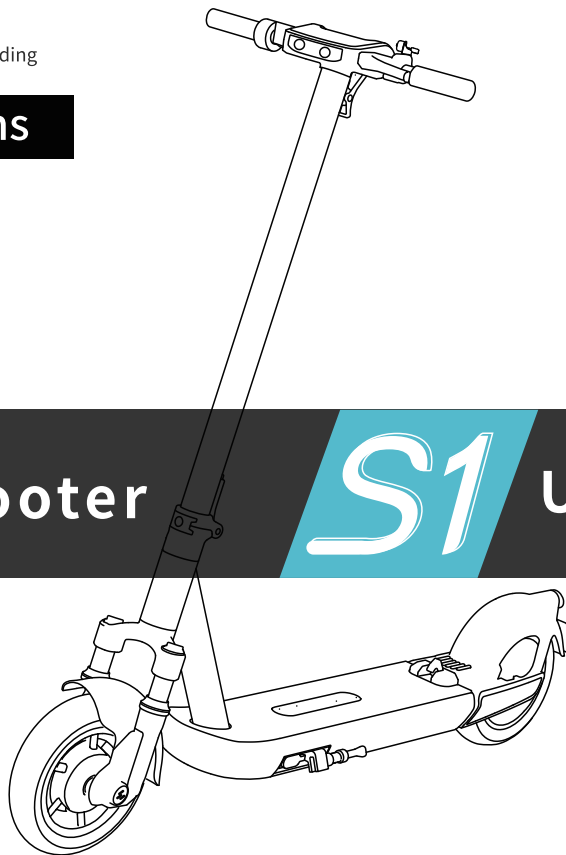

Inmotion Technologies Co., Ltd.
www.inmotionworld.com

***i*NMOTION**

Welcome!

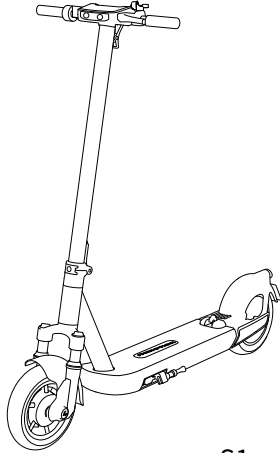

S1

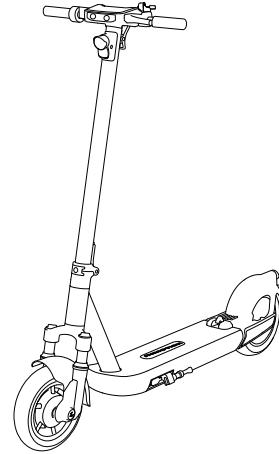

S1G

All pictures in this manual are for reference only, please refer to the actual product.

Thank you for choosing Inmotion Electric Scooter S1 (hereinafter referred to as scooter).

This scooter is easy to fold and easy to carry, It is also a sports.... it is a sports entertainment equipment with stylish technology

Contents

1	Safety instructions	1
2	Packing list	4
3	Product function diagram	6
4	How to assemble	8
5	Initial use	10
6	Connect the charger	11
7	How to ride?	12
8	Potential safety hazards	13
9	Folding and carrying	15
10	Daily care and maintenance	16
11	Specification	18
12	Trademarks and legal notices	20
13	Warranty	24

1 Safety instructions

1. The electric scooter S1 is a product designed for personal urban transportation, which have the property of a means of transportation, and the safety risks which all means of transportation may have.
2. Follow the tips and warnings in this manual can reduce risks, but it cannot eliminate all risks. Please keep in mind that when you use a scooter, you may be at risk of injury or death due to loss of control, collision, and falls. The scooter is only suitable for the hard pavement above, it is recommended to use it in alternately closed pavement environment (such as inside the community, parks, special venues, etc.) Do not pass through places with obstacles and contacts. When entering an unfamiliar environment, be vigilant and slow down.
3. Please wear a helmet and protective gear when riding. Please use an approved bicycle or scooter helmet..
4. For the first riding, please do not choose areas where children, pedestrians, pets, vehicles, bicycles or other obstacles and potential hazards may appear.
5. Please respect the right of pedestrians when riding. Avoid frightening pedestrians, especially the elderly, children, the disabled and pregnant women. When approaching pedestrians from the rear, remind pedestrians and slow down when passing. Please abide by local traffic laws and regulations.
6. When riding in countries and regions where there are no laws and regulations related to electric scooters, you must strictly abide by the safety requirements for cyclists in this manual. Inmotion will not assume any responsibility for any property loss, personal injury / injury, accident or legal disputes caused by the use behavior that violates the safety tips in this manual.
7. Before lending your scooter to someone else, make sure that they have read this manual, watched the instructional video, and learned novice instruction. You are responsible for ensuring the safety of new riders. Please assist him / her to learn to use this product until he / she learns the basic operation of this scooter. Please ensure that each new rider wears a helmet and other protective gear.
8. Before ride it, please check and make sure no loose fasteners and damaged parts. If the scooter makes abnormal noise or alarm sound, please

stop using it immediately and consult with your purchasing point or email to manufacturer.

(service@imscv.com).

9. Please observe the road surface when riding, avoid obstacles and smooth ground (including but not limited to wet ground, loose sand, stone ground and ice surface).

10. In order to reduce the risk of injury, you must read and follow all "Caution" and "Warning" notices in this manual. This product is suitable for users aged 14-60 years old and weighing less than 140kg. Please comply with the following safety tips:

A. Those who are not suitable for riding this scooter include:

i. Persons affected by alcohol or drugs.

ii. Persons unable to engage in vigorous physical activities due to illness.

iii. Unable to maintain balance.

iv. Persons whose weight exceeds the prescribed limit (please refer to the instruction manual "Model Parameter Table").

v. Pregnant woman.

B. Minors need to ride scooters under adult supervision.

C. Please abide by the local laws and regulations while riding. Do not ride scooters in areas prohibited by the local law.

D. For a safe ride, you must ensure that you can see the area in front, and you could be seen by others.

E. Whatever the reason, please do not ride the scooter when it is snowing, raining, slippery, muddy or icy. Do not ride a scooter across obstacles (sand, stones or roadblocks), which may cause a loss of balance or grip, and result in a fall.

F. Damages and losses due to water ingress are not covered by the warranty. G. Please do not drive at night.

H. Please do not suddenly accelerate or decelerate. Please do not drive at a speed exceeding the limit of the scooter, otherwise there may be a risk

of runaway, collision and falling.

11. Please do not try to charge your scooter when the charging port, charger or power outlet is wet.

12. Make sure using the original chargers from Inmotion to charge the scooter.

13. Only use parts and accessories approved by Inmotion. And do not modify your scooter. Modifications to the scooter may affect the operation of the scooter, resulting in serious injury / damage and invalid warranty.

14. Children should not use scooters or play scooter parts. When riding, the car body vibration will cause the driver's body vibration.

15. It is recommended to park on a flat and solid ground. If parking on a slope, the kick stand must face downhill to prevent overturning. Do not allow the scooter head to rush down to prevent the kick-stand support from closing under gravity and the vehicle toppling over. After put down the kick-stand, please check whether the scooter body is stable and prevent the scooter (from sliding, wind or shaking) from tipping over. Do not park in busy areas. It is recommended to park near the wall. Please park the scooter on a flat road as much as possible.

16. In order to get a better driving experience, it is recommended to maintain the product regularly.

17. Please read the user manual before charging.

18. Do not touch the brake parts of scooter, injury may cause.

- This appliance can be used by children aged from 14 years and above and persons with reduced physical, sensory or mental capabilities or lack of experience and knowledge if they have been given supervision or instruction concerning use of the appliance in a safe way and understand the hazards involved. Children shall not play with the appliance. Cleaning and user maintenance shall not be made by children without supervision.

- This appliance contains batteries that are not replaceable.

- The appliance is only to be used with the power supply unit provided with the appliance.

- Detachable supply unit

- IMPORTANT! Read carefully and keep for future reference

- Any load attached to the handlebar will affect the stability of the vehicle

- Braking distances may be extended during wet weather.

- It is necessary to check that the steering system is correctly adjusted, that all connection elements (such as a folding system) are correctly tightened and not broken, and that the brakes and wheels are in good condition.
- Always wear shoes.
- WARNING! As with any mechanical component, a vehicle is subject to high stresses and wear. The various materials and components may react differently to wear or fatigue. If the expected service life for a component has been exceeded, it may break suddenly, therefore risking causing injuries to the user. Cracks, scratches and discoloration in the areas subject to high stresses indicate that the component has exceeded its service life and should be replaced.
- Traffic in the city has many obstacles to cross such as curbs or steps. It is recommended to avoid obstacle jumps. It is important to anticipate and adapt your trajectory and speed to those of a pedestrian before crossing these obstacles. It is also recommended to get out of the vehicle when these obstacles become dangerous due to their shape, height or slippage.
- WARNING! Keep plastic covering away from children to avoid suffocation.
- Take the time to learn the basics of the practice to avoid any serious accident that can take place in the first months
- Get closer to your seller so he can refer you to an appropriate training organization.
- Avoid high traffic areas or overcrowded areas.
- In any case, anticipate your trajectory and your speed while respecting the code of the road, the code of the sidewalk and the most vulnerable.
- Cross the protected passages while walking.
- In all cases, take care of yourself and others.
- Do not divert the use of the vehicle.
- This vehicle is not intended for acrobatic use.
- Caution, the brake may become hot in use. Do not touch after use.
- Regularly check the tightening of the various bolted elements, in particular the wheel axles, the folding system, the steering system and the brake shaft.
- Eliminate any sharp edges caused by use.
- Power-off the vehicle during charging, or into a certain non-operational mode.
- Regular maintenance of the vehicle is a factor of safety.
- The self-tightening nuts as well as the other self-tightening fastenings may lose their efficiency and that they may need to be retightened.

2 Packing list

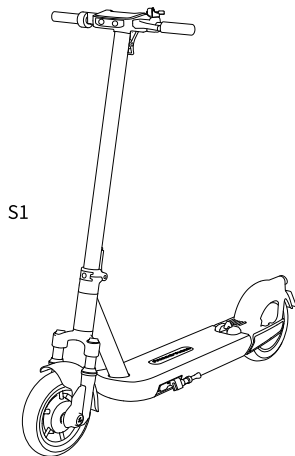

User manual

Unboxing
Instruction manua

Accessories

Power cable



Power adapter

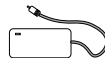

Extended
air valve

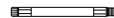

Allen wrench



Screws



Lid



Gland screw



Clamp



Folding ring



Please carefully check whether the items in the packing box are complete and intact. If there is any part missing or damaged, please contact your point of purchase or email to manufacturer (service@imscv.com).

3 Product function diagram

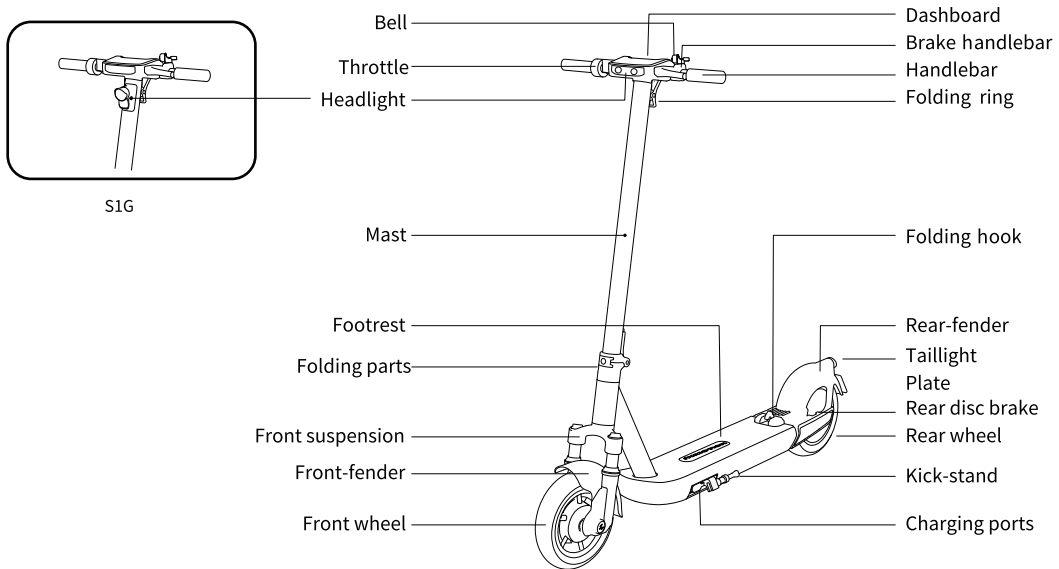

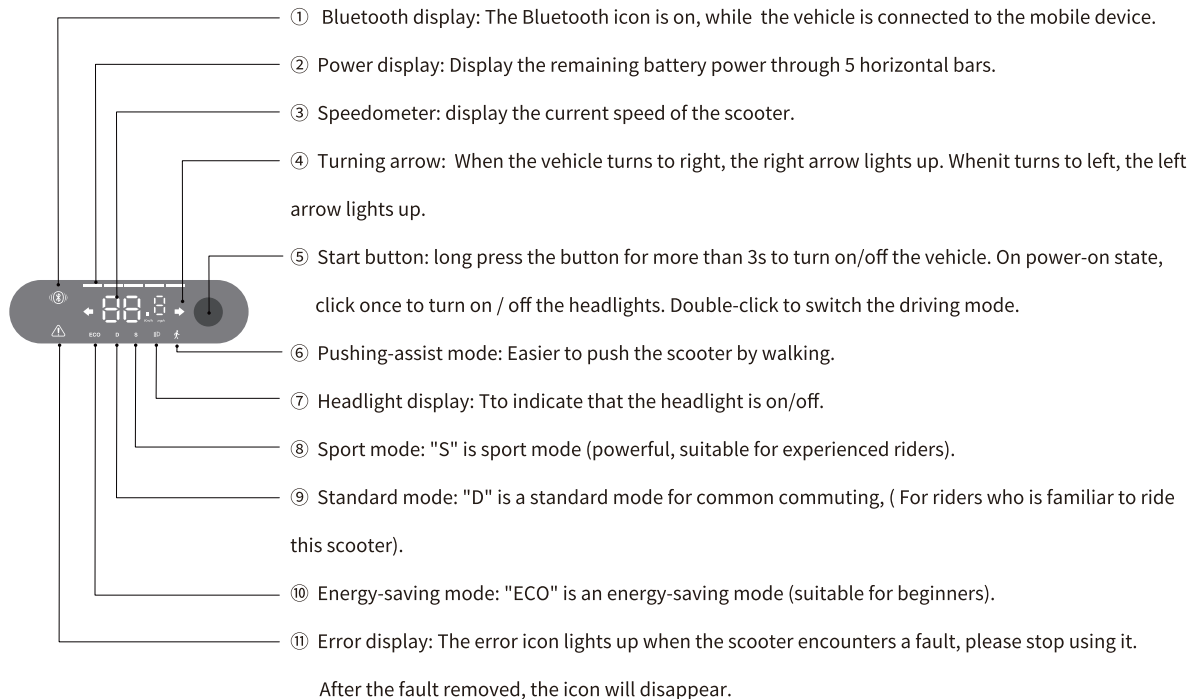

Dashboard & Power on/off

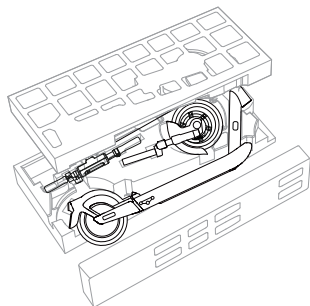

4 Scooter assembly



Assembling Accessories List

	Screws x 7
	Gland Screw x 1
	Stem Hook x 1
	Screw Wrench x 3

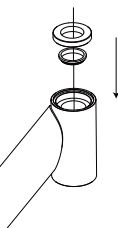

Picture ①

1. Please don't take out the whole vehicle after you open the package. First, check all the accessories on the list. (If the parts of the connection of the deck and the stem are littering in the package, please put them in order as the Picture ① shows.)

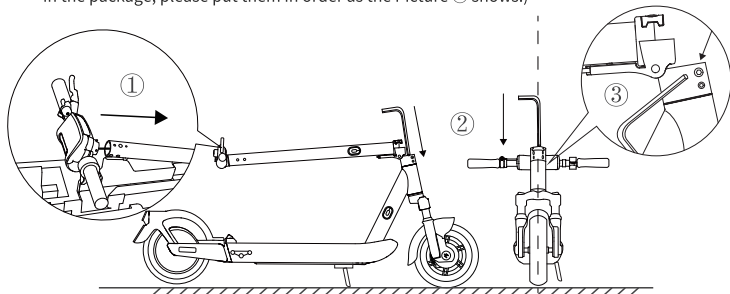

3. Adjust the handle bar. ① Put the handle bar and dashboard part into the tube of the stem. The side with the light is at the front. (Don't lock the stem now) ② Take out the body of the scooter and put it stand on the ground with the kickstand. Adjust the handle bar and the rear wheel in the same line as the Picture ② shows. Tighten the Gland Screw to make sure it's not loosen. ③ Fasten the screws below the folding parts to make sure it's secured.

How to assemble the gland screw

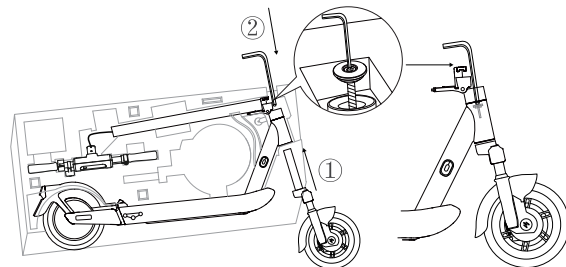

2. Keep the body of the vehicle fixed at the package: ① Take out the whole front fork part, and put it into the tube of the stem. ② Assemble the screw, and insert it into the front fork part with the screw wrench. To adjust the handle bar later, please don't lock it too tight. After you adjust the handle bar, you can tighten it.

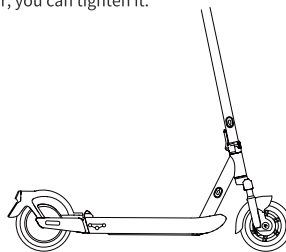

4. Unfold the scooter by putting back the stem. Put the cable back into the tube and turn the handle bar left to right to check if it's natural and smooth.

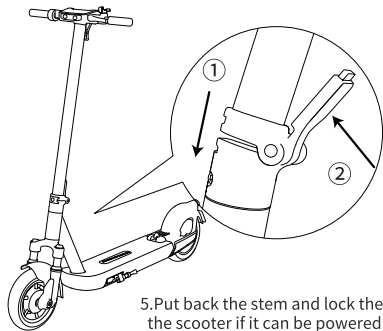

5. Put back the stem and lock the folding wrench. Check the scooter if it can be powered on and off normally. If it's normal, go to the next step. Be carefully when you are holding the handle bar part.

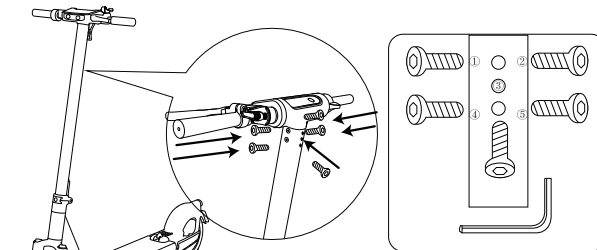

6. Fasten the 5 screws to fix the handle bar. 2 Screws on the two sides. One screw at the middle hole of the back of the stem.

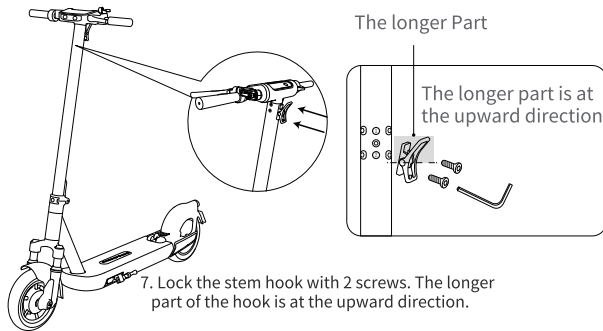

7. Lock the stem hook with 2 screws. The longer part of the hook is at the upward direction.

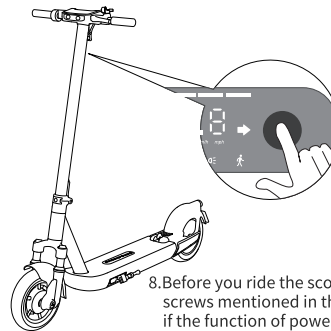

8. Before you ride the scooter, please fasten all the screws mentioned in this tutorial menu. And check if the function of powered on and off and the other functions can work normally.

5 Initial use



There are safety risks when using scooters. Before the initial use, users must carefully read the safe driving guide through the APP. For safety consideration, the new scooter is not activated, and there will be intermittent beep prompts after booting. Before activation, the speed of the scooter was very low and all functions could not be used. You need to install the APP on your mobile device (Bluetooth 4.0 and above), connect your scooter via Bluetooth, and activate your scooter as prompted by the APP.

Scan the QR-code to download Inmotion App.

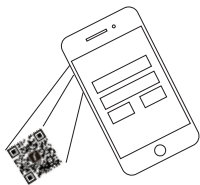

1. Install Inmotion App on Android or iOS devices, register it and log in.

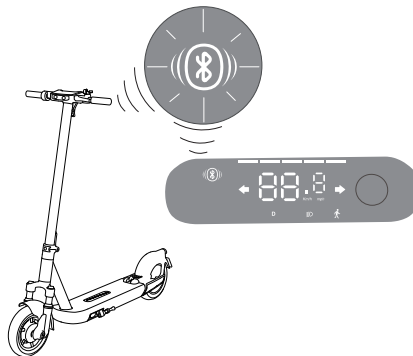

2. When the scooter is turned on, by default, Bluetooth enters the status of waiting connection. Connected to the scooter with APP. The icon is always on once the connection is successful, and the user can start using the APP to operate.

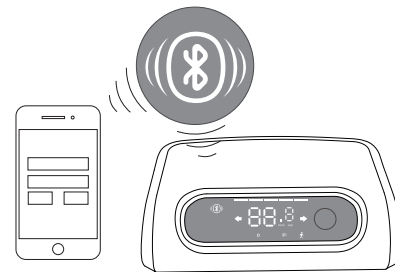

3. Follow the tips from the App and activate the scooter, and learn how to drive safely. Now, you can start using your scooter, and check its status and function and operate via the APP.

6 Connect the charger

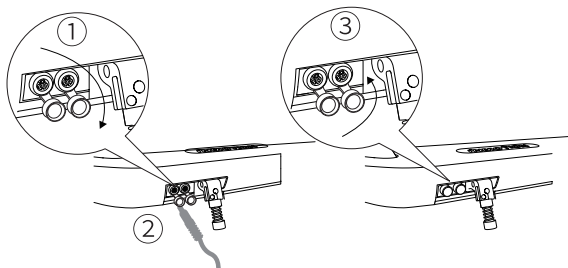
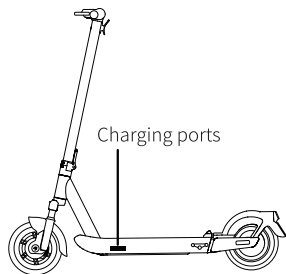

Steps: Open the cover of charging ports and plug in the charger. Cover back after charging.

Warning



Use the original charger, otherwise the battery may be damaged or cause danger! Do not connect the charger when the charging port or charging cable is wet! If the battery is damaged or gets into water, it is forbidden to charge or continue to use the battery!

7 How to ride

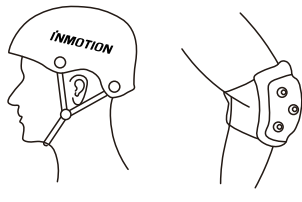

Please take safety measures when riding, such as: wearing sports clothes, wearing helmets, knee pads, elbow pads and other protective tools.

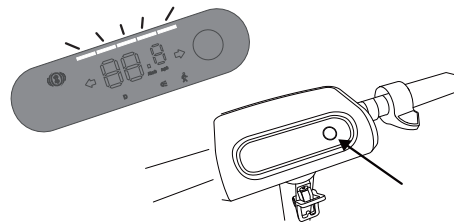

1. Long press the power on / off button until the ring lights are fully illuminated. Check the battery indicator. If the remaining battery is too low, please charge immediately.

7 How to ride

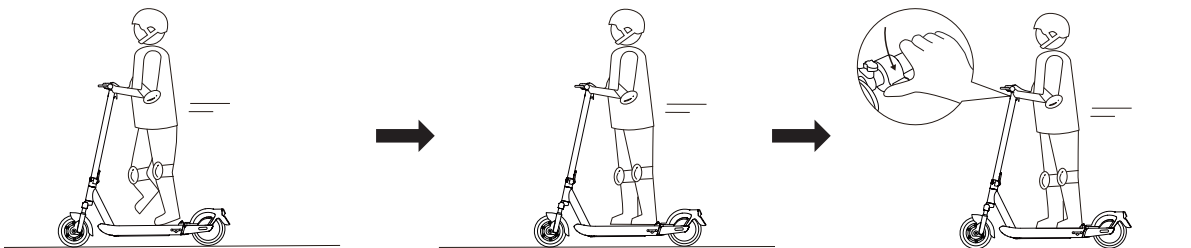

2. Stand on the footrest with one foot, the other foot kicked back on the ground and began to glide. The motor can only be started after the vehicle speed reaches 3km / h. Gently press the throttle on the right handlebar, the scooter can ride slowly, hold the handlebar to control the riding direction (similar to riding bicycle).

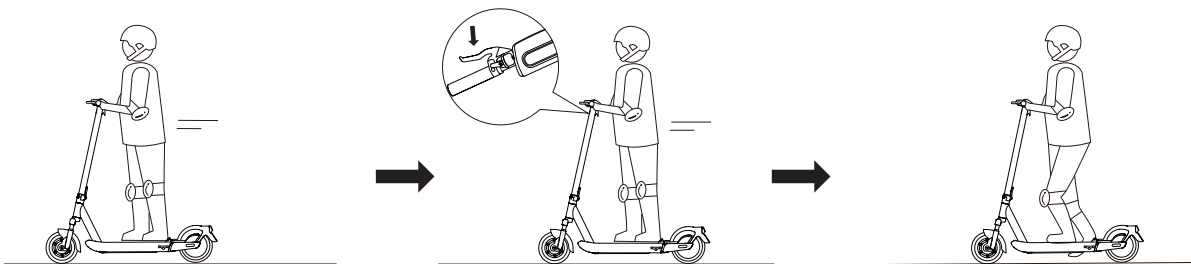

3. Gently press the throttle on the right handlebar to accelerate, but please do not be too fast. Hold the brake to make the scooter slow down (Try to avoid emergency braking). When the scooter stops or taxis slowly, get down one foot first, then get off normally.



To avoid accidental touch, by factory default, the motor and throttle will be started only when scooter be in the taxi state, and the throttle does not work after the scooter stops.

8 Potential safety hazards

 Failure to follow these instructions may result in serious injury.

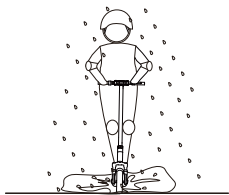

Avoid riding in the rain.

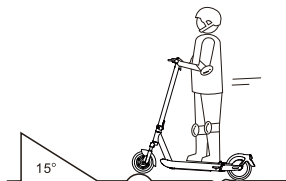

Do not ride at a high speed when pass by the bumps and potholes, it's a good recommendation to keep slow to medium speed on rough road. (5-10km/h) .

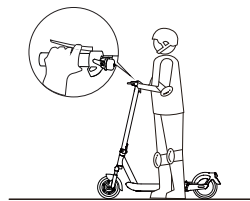

Do not press the throttle when pushing the scooter.

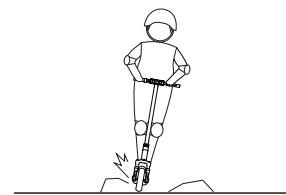

Pay attention to road conditions and avoid obstacles while riding.

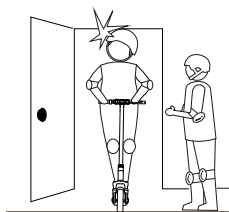

Avoid hitting high obstacles such as door frames and elevators.

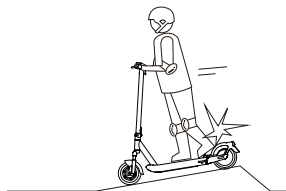

Do not step on the rear fender.

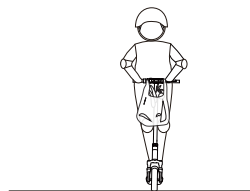

Do not hang heavy objects on handlebars and other parts of scooter.



Do not ride at the Non-standard postures, such as: riding on with one foot on footrest or one hand on handlebar.

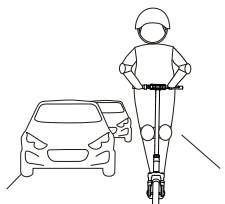

Do not ride it in public street if not allow by the laws.

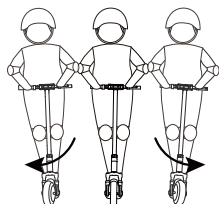

Do not turn the handle greatly on high-speed riding.

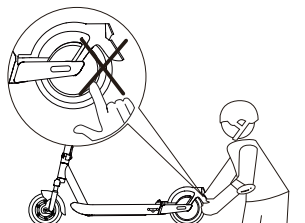

Do not touch, if the motor causes high temperature and heat during operation.



Do not hands free from handlebars while riding.

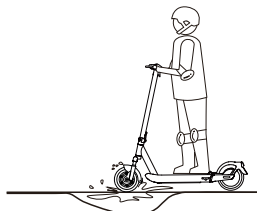

Don't go straight through the puddle, please go around it with a low speed.

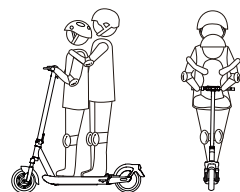

For one rider only, do not ride with other person or holding the child. Not suitable for pregnant women.

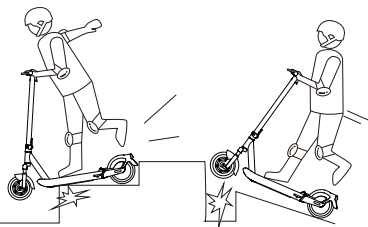

Do not ride scooters up and down steps or jump obstacles.



Do not using cell phone or headphone on riding.

9 Folding and carrying

Fold unlock button

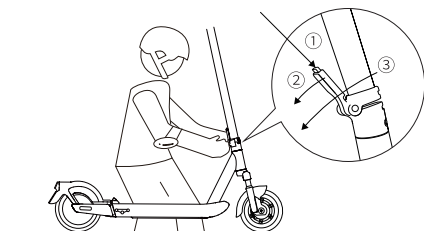

Power off the scooter, one hand hold the mast, and the other hand press the fold-unlock button and pull back the folding wrench. Then fold the mast backward.

Press down the folding ring

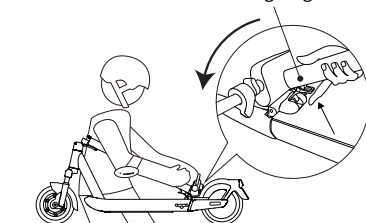

After folding down the mast, press down the folding ring, and align it with the hook on the rear end of footrest, release the folding ring to hook it successfully.

Press down the folding ring and lift up the mast

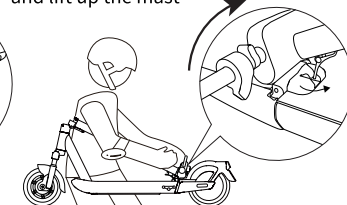

To unfold the scooter. Press down the mast, at the same time hold the folding ring until release it from the hook, and straighten the mast to ensure the folding wrench back to its position tightly.

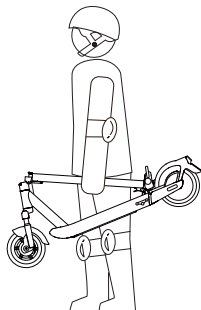

You could carry it after folding.

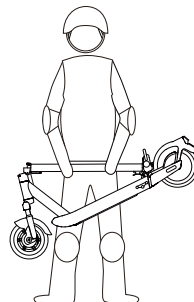

You could carry it after folding.

10 Daily care and maintenance

Cleaning and storage

Wipe the main frame of scooter with a soft damp cloth. If any stains which is difficult to clean, brush repeatedly with a toothbrush and toothpaste, then clean with a soft damp cloth.

Tips: Do not use alcohol, gasoline, kerosene, or other corrosive, volatile solvents to clean your scooter. These substances may damage the appearance and internal structure of the body of scooter. It is forbidden to spray the scooter with pressure water-gun or water pipe.

Warning

Before cleaning, make sure the scooter is powered off, and the charging cable has been unplugged and the rubber cover of the charging port has been fastened. Otherwise it may cause damage to electronic components or the battery. When scooter is not in use, please place it in a bright and dry place. Do not park the scooter outdoors. Sun exposure or extreme temperature conditions (overheating and too cold) will accelerate the aging of plastic parts and may lead to a reduction in battery life.

Battery dis-assembly and maintenance

Please don't take the battery out if not necessary. It's a little complicated to dis-assembling the battery, and which may affect the operation to the body of scooter. And it's better to let the professional staff to install the tires. Any improper operation may cause the body of scooter be unstable or with other failures:

1. Do not use battery made by 3rd parties if without authorization, otherwise there may be safety risks.
2. Recharge the scooter with original charger, otherwise there may be a risk of damage or fire.
3. Do not touch the battery contacts, and do not dis-assemble or pierce the case of battery. Avoid the short circuit caused by metal objects touching the battery contacts, otherwise it may cause battery damage or personal injury.
4. It is forbidden to put the battery into fire, otherwise it may cause the battery to fail, overheat, or even risk of fire.
5. Please fully charge the scooter before store it, which is helpful to prolong the battery life. Do not exceed the limit of specified temperature (refer to the table of parameter) while store and charge the battery.
6. The Improper disposal to used batteries may seriously pollute the environment. Please comply with the local regulations when dispose of the battery. Do not discard this battery as one's desire.

The battery in good condition can maintain a good operating state even after driving for many miles. Please re-charge the battery on time, to avoid the battery is completely draining. At the indoor temperature 22 ° C, the battery has the best battery life and performance. However, at the temperatures under 0 ° C, the battery life and performance may degrade. Check more info on Inmotion APP.

Reminding

Please do not try to dis-assemble the battery, otherwise there is a risk of fire. Users is not allowed to repair the parts contained in this scooter by themselves, if without authorization.

Warning

Please do not try to dis-assemble the battery, otherwise there is a risk of fire. Users is not allowed to repair the parts contained in this scooter by themselves, if without authorization.

Warning

Do not ride this scooter when the ambient temperature exceeds the product operating temperature (please refer to parameter table). The extra power lost would caused by the low / high temperature, meanwhile, slipping or falling may occur, resulting in personal injury or property damage.

For product maintenance, repair and other related questions, please contact your point of purchase or email to service@imscv.com.

11 Specification

Specification		S1	S1E	S1F	S1G
Dimension of product	Unfold: L*W*H	1307*520*1275mm			
	Fold: L*W*H	1307*520*560mm			
Weight	Net weight	Approx. 24kg			
Recommendation	Max. of payload	140 kg			
	For age at	14+ year			
	For height at	130-200cm			
Performance	Max. of speed	30km/h	25km/h	40km/h	20km/h
	Mileage[1]	Approx. 95km			
	Max. of slope	Approx. 30%			
	Working temperature	-10— 40°C			
	Storage temperature	-20— 45°C			
	IP rating	IP55			
battery	Charging time	Approx. 7h (single charger), Approx. 3.5h (Dual chargers)			
	Rating voltage	54V			
	Max. of voltage	63V			
	Charging temperature	0— 40°C			
	Capacity	675Wh			
	BMS	Overheat / short circuit / overcurrent / overcharge protection			

Motor	Rating power	500W
Charger	Input voltage	AC100-240V 50/60HZ
	Output voltage	DC63V
	Output current	2.0A
Tyre	Front / Rear	10" Pneumatic tire, tubeless
Others	Brake light	LED taillight
	Turning light	Sensor-activated automatically
	Ride modes	Eco- mode, D-mode, S-mode

Operating frequency:2402-2480MHz

RF Power(Max):0.78dBm

Charger model:XVE126-6300180

Noise value:The A-weighted emission sound pressure level does not exceed 70 dB(A)

The method for adjusting the brakes and recommendations concerning the replacement of friction components: Rotate the brake K mother clockwise, the brake is strong, the user can reasonably adjust it according to their needs, if the adjustment is too large, it is easy to cause the front wheel to lock up and create a safety hazard.Turning K counterclockwise reduces the braking force and lengthens the braking distance.

[1] Mileage: Tested under full power, 75kg load, 25 ° C, riding at a cruising speed on a flat road at 18km / h.

12 Trademarks and legal notices

Inmotion is a registered trademark of Inmotion Technologies Co., Ltd. ; Android is a trademark of Google; App Store is a sign of Apple service; other trademarks mentioned in this article are belong by their owners. When printing this manual, it has included as many function introductions and instructions as possible. However, due to the continuous improvement of product functions and design changes, it may still be inconsistent with the product you purchased. Respect. Please scan the QR code on page 6, download the APP for Android or iOS devices and read the latest version of this manual. Due to product updates, the actual product may deviate with the color and appearance mentioned in this manual. Please refer to the actual product.

All rights reserved by Inmotion Technologies Co., Ltd.

Manufacturer: Inmotion Technologies Co., Ltd.

The more familiar you are with scooter, the more safety you will get on riding. Therefore we suggest you to:

1. Read this user manual carefully before riding.
2. Do not allow other people to ride this scooter before they read this manual carefully.
3. You are obliged to know all relevant laws, regulations and policies regarding riding scooters in your area, and strictly comply with applicable laws, regulations and policies.

Safety instructions we suggest you to:

1. Please wear a helmet with appropriate size when riding.
2. This scooter may contain detachable parts, which should avoid the harm caused by children swallowing.
3. Scooters is similar like other sports equipment, you must be very careful on riding. You must make sure you' re able to ride a scooter freely without any assistance, before riding. It is forbidden to ride fatigue, take drugs or drink. It is recommended that you do not ride a scooter during illness, pregnancy or when you have any bad emotions, chase. No racing and overload.
4. If some damage, emits odor, smoke, overheating or performance failure or abnormality parts on the scooter, please do not continue to use the scooter and contact with after-sales service in time.
5. When any smoke emitted out from the inside of scooter (even the probability is only 1 in 1 million), please immediately put the scooter into an empty unmanned area, or try to cool down it. Please pay attention to avoid damaging other property or causing any personal injury.
6. Scooter is not medical devices and it' s not recommended to be used as medical aids.

7. Do not throw or drop the scooter. Do not place the scooter in an open flame or high temperature.
8. The scooter move spontaneously may caused by parking without turning off , which may bring damage to others or property around it.
9. The unauthorized modification may endanger your safety on riding, Do not modify the scooter in any form without permission.

The requirement of environment for riding:

1. Do not ride on inclined roads, uneven ground, slopes greater than 30%, area near swimming pools and other place with slippery, stagnant water, evacuated materials, etc. which may affect normal riding or not safe. Do not ride in areas where is not permitted to ride by the local laws, regulations or policies.
2. For your safety, please do not take risks to ride through those terrain you have not encountered before, such as steep slopes, inclined roads.
3. Do not ride in these following situations: bad weather, low visibility, at dawn, dusk, thick fog, thick smoke, night or darkness, or extreme fatigue, each of these conditions above would increases the risk of accidents.
4. Do not ride a scooter in rain or snow. After riding, please park the scooter indoors to avoid damage to the scooter due to water ingress caused by rain and snow. Be careful, the resistance of wheels on wet roads is relatively reduced, which will be more difficult for the rider to control the speed.

The requirement to rider:

1. The rider must be more than 14 years old and with weight no more than 140 kg. As a parent or guardian, you are responsible for the activities and safety of your minor children. Parents or guardian should accompany with the minor children throughout the riding journey to avoid danger.
2. It's not recommended to ride the scooter to persons with difficulties in sight, hearing, body, language, and movement . Anyone with serious heart, high blood pressure, dizziness and other diseases that are not suitable for sports is strongly recommended not to ride the scooter. No riding on this scooter after taking drugs and alcohol.

Preparation before riding:

1. Please read this manual carefully. All the components of the scooter must be correctly installed according to the instructions, meanwhile, make sure the installation is not too loose or too tight, to avoid damage or failure.
2. Before riding, please check the installation status, wheel performance and battery status according to the instruction in manual. Make sure the scooter is a proper status, no signs of loosening or damage on any parts. If any signs of abnormality, please stop riding it immediately and contact the after-sales for checking and guidance.
3. The scooter does not have enough power to maintain your normal riding while the power display is low and empty. Make sure the power is sufficient before riding, in order to avoid any danger.
4. To ride a scooter, you must wear a helmet. And the knee pads, gloves, wrist guards, elbow pads, and sports shoes are recommended.
5. No high heels, slippers and open-toed shoes when riding a scooter.
6. It is recommended to wear protective glasses on riding, to protect your eyes from dirt, dust and insects in the air.

Notes on riding

1. Please comply with the local laws, regulations and policies on riding.
2. Start smoothly on a flat road, and do not accelerate or brake sharply on riding, And hold the handle with both hands always.
3. Please be vigilant on riding and always maintain good judgment. Keep a suitable speed and safe distance with other vehicles. Please slow down when driving into a unfamiliar environment.
4. In order to avoid distraction on riding, do not wear headphones, earplugs, make phone calls, take pictures, take pictures.
5. Be defensive on riding. Pay attention to yourself, vehicles and pedestrians.
6. Make sure you are visible on riding to others.
7. One rider only. Do not ride with others on one scooter, including children and pregnant women.

Battery maintenance and storage

1. Please use the original battery. Do not use battery from unauthorized suppliers, otherwise there may be safety risks.
2. Please use the original charger, otherwise the battery may be damaged or in danger of fire.
3. There are harmful substances in the battery, please do not try to damage or disassemble the battery.
4. If the battery is damaged or gets into water, do not recharge it or continue to use this battery.
5. Do not plug in the charger when the charging port or charging cable is wet.
6. It is strictly forbidden to disassemble, squeeze or puncture the product, forbid touching the battery contacts, disassembling or piercing the casing. Do not put this product into water or fire (including close to the furnace and other heat sources). Avoid short circuit caused by metal objects touching the battery contacts, otherwise it may cause battery damage or personal injury.
7. It is strictly forbidden to immerse the battery and scooter in water or ride in the rain. And do not clear the scooter by the strong water flow and high-pressure hoses. If your scooter has been exposed to heavy rain or has been riding for a long time in the rain, please wipe the scooter with a dry soft cloth in time, stop using it immediately, and consult with the service staff.
8. Do not place the scooter in the environment over 45 °C or below -20 °C (for example, do not put the scooter or battery in a car exposed under the sunshine in summer). Before charging, if the battery was stored under the environment temperature lower than 0 °C, please put the scooter in a warm environment (more than 10°C) for a while until the battery reaches the charging temperature requirement (0-40 °C).
9. Warning: Due to the improper use above, the performance of battery is attenuated or can not be used normally, which is not covered by the scope of warranty.
10. The environment may be polluted by the Improper disposal of used batteries. Please comply with the local laws and regulations when discard of the battery.

Others

1. The data and parameters of the scooter will be varied with different models. It may be subject to change without notice.
2. To the extent permitted by the law, Inmotion reserves the right to interpret and explain this statement. This statement is applied by the laws of the People's Republic of China. Caused by or may cause. With compensation, liability and loss, Inmotion will not be liable for compensation. Riders shall bear their own responsibility for unforeseen or occurring risks encountered on riding.

Thank you again for your choice and trust in Inmotion.

13 Contact

Contact us if you experience issues relating to riding, maintenance, and safety, or errors/faults with your E-Scooter.

INMOTION TECHNOLOGIES CO., LTD.

Address: 18/F, B1, Nanshan iPark, No.1001 Xueyuan Ave., Nanshan, Shenzhen, China

Tel: 4000100012 ext.8015

E-mail Service: service@imscv.com

E-mail Amazon USA Service: AmazonService@imscv.com

Website: www.inmotionworld.com

INMOTION APP: Me → Online Service.



Download Inmotion App

Version:V3.1