

INMOTION
Climb Hills with Ease

Climber

Electric Scooter User Manual

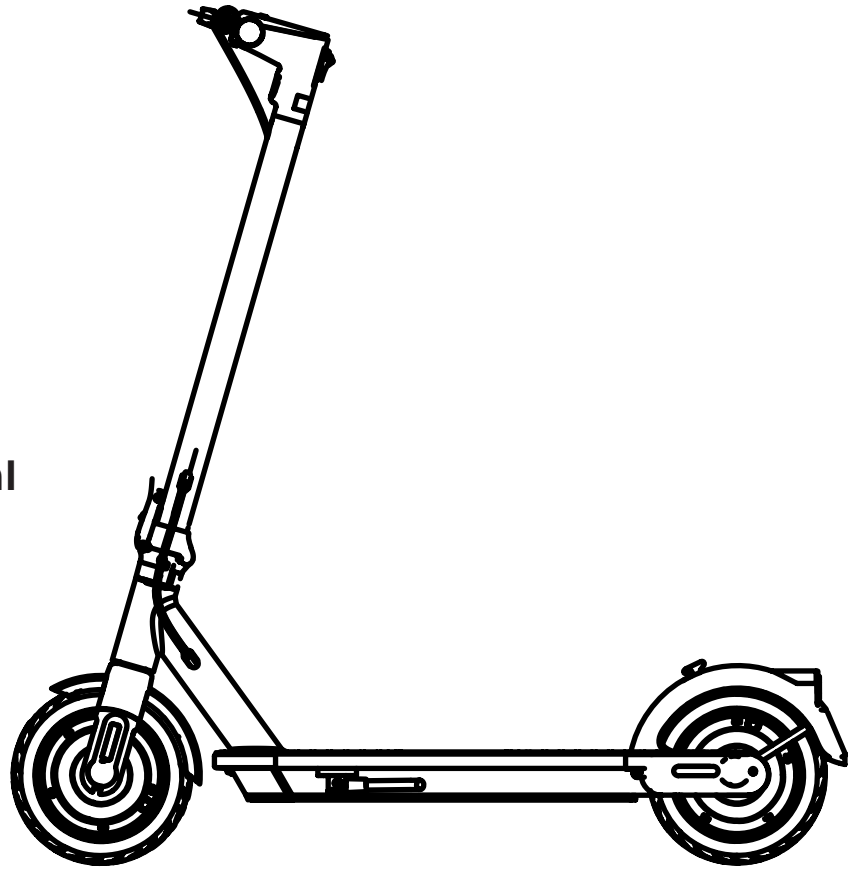

Inmotion Technologies Co., Ltd.
www.inmotionworld.com

For US only

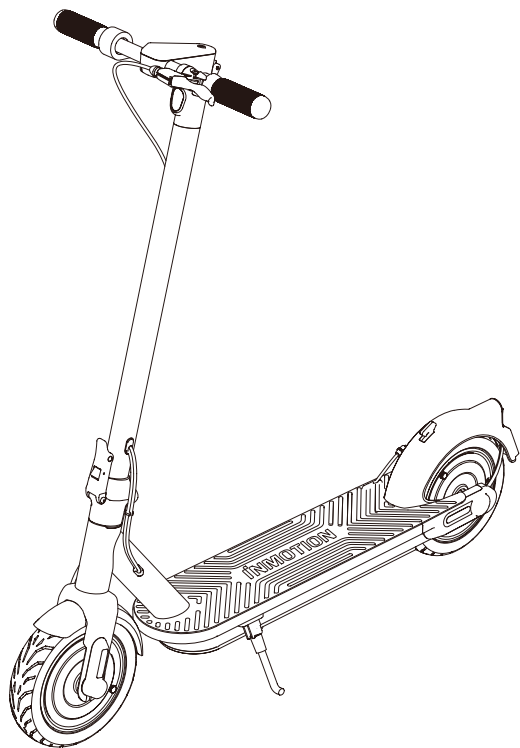

For EU only

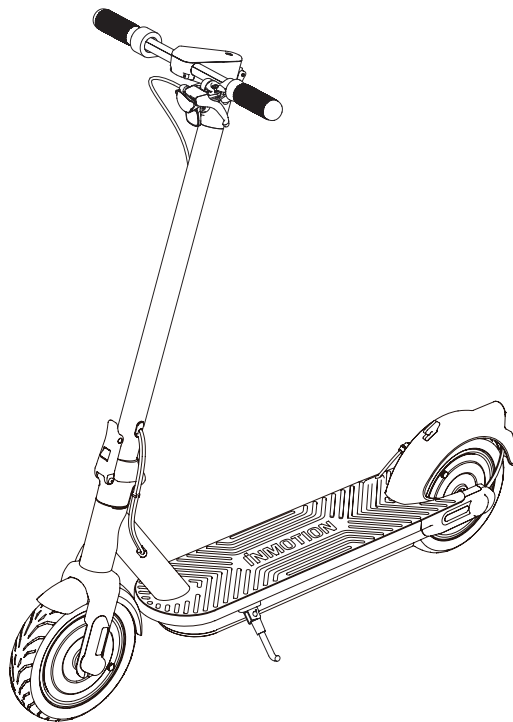

Contents

1 Safety Instructions	1
2 Parking list	4
3 Product Feature Diagram	5
4 Dashboard	6
5 Specifications	7
6 Assembly	8
7 Folding	9
8 Inflating the Tires	10
9 Charge Your Scooter	11
10 INMOTION App	12
11 How To Ride	13
12 Security Tips	14
13 Fault Code Messages	16
14 Maintenance	17
15 Before Your Ride	18
16 Environmental Protection.....	19
17 Certifications	19
18 Trademarks and Legal Notices	20
19 Contact US	20

1. Safety Instructions

- Electric scooter is a recreational device rather than a transporter. But once you ride it into a public community, it will also act as a transporter. Like any riding products, an electric scooter can and is intended to move and it is therefore, of course, possible to get into dangerous situations.
- Please understand that you can reduce the risks by following all the instructions and warnings in this manual, but you cannot eliminate all the risks.
- Remember that whenever you ride the scooter you risk injury or death from loss of control, collisions, and falls. The scooter is intended for use on flat pavement or level ground without bumps and obstacles. Be alert and slow down when entering unfamiliar areas.
- Always wear a helmet when riding. Use an approved bicycle or scooter helmet that fits properly with the chin strap in place, and provides protection for the back of your head. A long-sleeved shirt, long pants, and athletic shoes are recommended. Never ride in highheels sandals, high-heeled shoes or barefooted. Long hair or bangs that can affect vision should be tied up to avoid accidents caused by hair blocking vision.
- Do not attempt your first ride in any area where you might encounter children, pedestrians, pets, vehicles, bicycles, or other obstacles and potential hazards.
- Respect the rights and property of others. Pass on the left whenever possible. When approaching a pedestrian from the front, stay to the right and slow down. Be careful to avoid pedestrians, especially the old, children, the disabled, pregnant women. When approaching from behind, announce yourself and slow down to walking speed when passing. Please obey local traffic laws and regulations if situation is different.
- In places without laws comply with the safety guidelines outlined in this manual. INMOTION TECHNOLOGIES CO., LTD. will not be responsible for any property damage, personal injury/death, accidents or legal disputes caused by violations of the safety instructions.
- Do not allow anyone to ride your scooter on his/her own unless they have carefully read this manual and followed the riding guide video. The safety of new riders is your responsibility. Assist new riders until they are comfortable with the basic operation of the scooter. Make sure each new rider wears a helmet and other protective gear.
- Before each ride check for loose fasteners and damaged components. If the scooter makes abnormal sounds or signals an alarm, immediately stop riding. Diagnose your scooter via the INMOTION App and contact after-sales service at service@imscv.com.
- Be alert! Scan both far ahead and in front of your scooter - your eyes are your best tool for safely avoiding obstacles and low traction surfaces (including, but not limited to, wet ground, loose sand, loose gravel, and ice).
- To reduce risk of injury, you must read and follow all "CAUTION" and "WARNING" notices in this manual. Do not ride at an unsafe speed. Under no circumstance should you ride on roads with motor vehicles. The manufacturer recommends riders aged between 14-60 years old and weighed less than 130kg. People who should not ride the scooter include:

- a. Anyone under the influence of alcohol or drugs.
 - b. Anyone who suffers from disease that puts them at risk if they engage in strenuous physical activity.
 - c. Persons with reduced physical, sensory or mental capabilities or lack of experience and knowledge if they have been given supervision or instruction concerning use of the appliance in a safe way and understand the hazards involved.
 - d. Anyone who has problems with balance or with motor skills that would interfere with their ability to maintain balance.
 - e. Anyone who is severely overweight (see specifications).
 - f. Pregnant women.
 - g. Riders under the age of 14 years old should ride under adult supervision.
- The vehicle shall be used only for one person.
 - Accessories and any additional items which are not approved by the manufacturer shall not be used.
 - WARNING ! As with any mechanical component, a vehicle is subject to high stresses and wear. The various materials and components may react differently to wear or fatigue. If the expected service life for a component has been exceeded, it may break suddenly, therefore risking causing injuries to the user. Cracks, scratches and discoloration in the areas subject to high stresses indicate that the component has exceeded its service life and should be replaced.
 - Traffic in the city has many obstacles to cross such as curbs or steps. It is recommended to avoid obstacle jumps. It is important to anticipate and adapt your trajectory and speed to those of a pedestrian before crossing these obstacles. It is also recommended to get out of the vehicle when these obstacles become dangerous due to their shape, height or slippage.
 - WARNING Keep plastic covering away from children to avoid suffocation.
 - Take the time to learn the basics of the practice to avoid any serious accident that can take place in the first months.
 - Get closer to your seller so he can refer you to an appropriate training organization.
 - Avoid high traffic areas or overcrowded areas.
 - Cross the protected passages while walking.
 - In all cases, take care of yourself and others.
 - Do not divert the use of the vehicle.
 - This vehicle is not intended for acrobatic use.
 - Caution, the brake may become hot in use. Do not touch after use.
 - Regularly check the tightening of the various bolted elements, in particular the wheel axles, the folding system, the steering system and the brake shaft.
 - Eliminate any sharp edges caused by use.
 - Do not modify or transform the vehicle, including the steering tube and sleeve, stem, folding mechanism and rear brake. Comply with local laws and regulations when riding this product. Do not ride where prohibited by local laws.
 - To ride safely, you must be able to clearly see what is in front of you and you must be clearly visible to others.
 - Do not ride your scooter in wet or icy weather, or on roads which are wet, muddy, icy, or that are slippery for any reason. Do not ride over obstacles such as sand, loose gravel or sticks. Wet, slick, bumpy, uneven or rough surfaces may impair traction and contribute to a loss of balance or traction and could cause a fall.

- Do not ride at night when visibility is limited.
- Sudden acceleration or deceleration could lead to wheel slip, collision or falls.
- Do not ride faster than the speed limit.
- Do not attempt to charge your scooter if it, the charger, or the power outlet is wet.
- Only use the INMOTION supplied charger. Use only with FY-4202000 supply unit. Do not use a charger from any other different product models.
- Use only INMOTION approved parts and accessories. Do not modify your scooter. Modifications to your scooter could interfere with the operation of the scooter, could result in serious injury and/or damage, and could void the limited warranty.
- Children should not use scooter or play with scooter parts. Cleaning and maintenance shall not be done by children without supervision. The vehicle vibration will cause the driver's body vibration while riding.
- Please park on flat pavement, such as on a slope, the scooter kickstand must be facing downhill to prevent capsizing. Please check whether the scooter is parked stably to prevent it overturned.
- Perform regular inspections of equipment and conduct regular cleaning on your scooter for better ride experience.
- This scooter contains batteries that are not replaceable.
- Use any battery charger other than the original.
-  Detachable supply unit.
- Any load attached to the handlebar will affect the stability of the vehicle.
- IMPORTANT! Read carefully and keep for future reference.
- Braking distances may be extended in wet weather.
- LPA and LWA: Do not exceed 70dB(A).
- In any case, anticipate your trajectory and your speed while respecting the code of the road, the code of the sidewalk and the most vulnerable.

2. Packing list

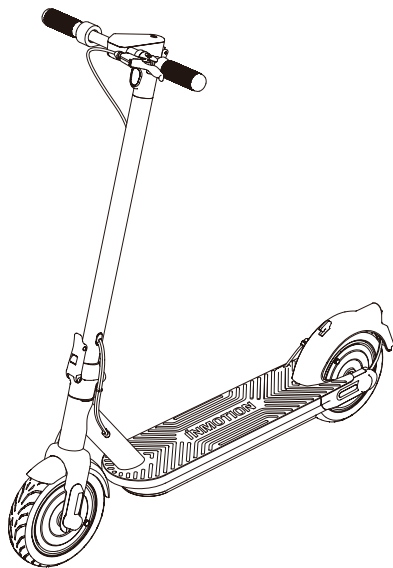

Assembled scooter

User Materials



User manual



Quick Start Guide

Accessories



1*Power cable

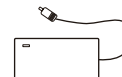

1*Power adapter



1*Extended air valve



2*Cover tyre

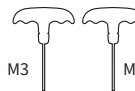

2*T-handle hex key

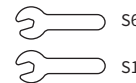

2* Allen wrench



5*M3 Screw

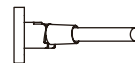

1*Kickstand



3*M5 Screw

WARNING

- Please carefully check whether the items in the packing box are complete and intact. If there is any part missing or damaged, please contact your point of purchase or email to manufacturer.
- Please retain the box and packaging materials at least 30 days in case you need to ship your scooter in the future.

3. Product Feation Diagram

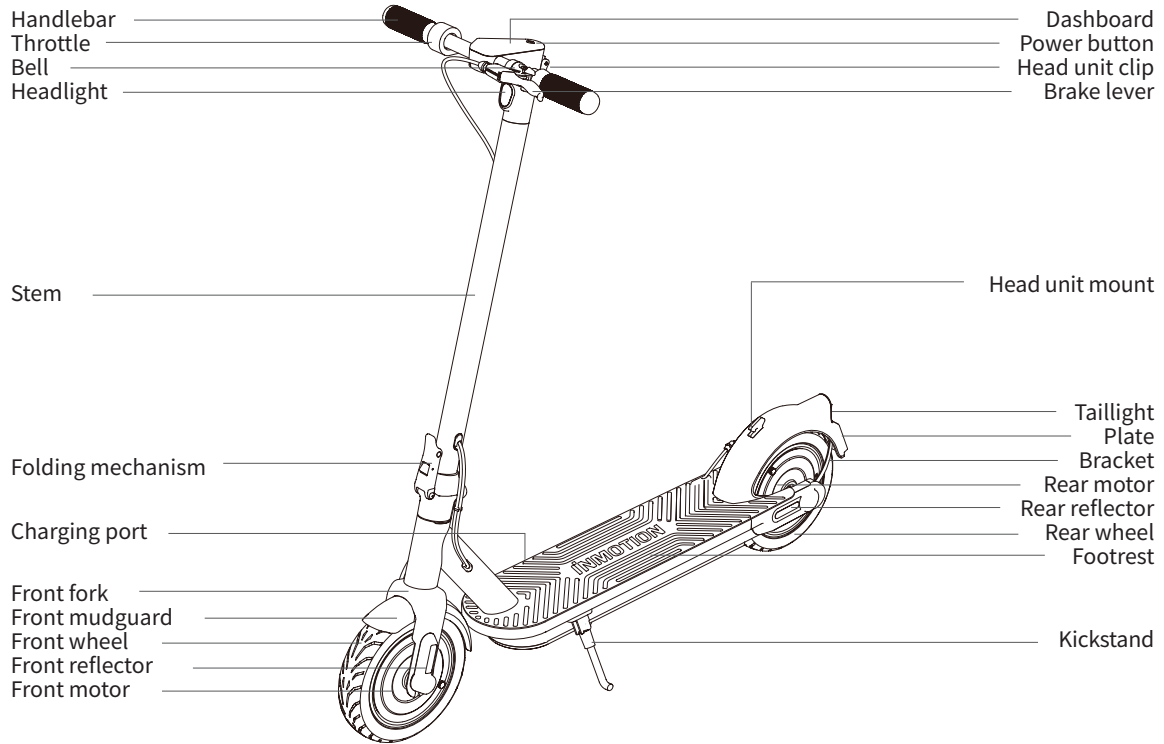

4. Dashboard

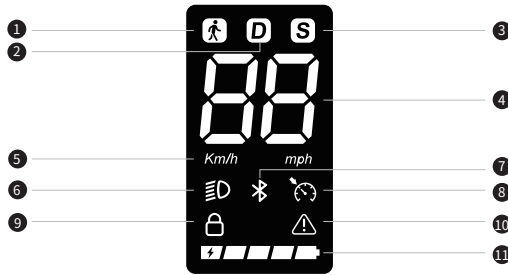

1. Pedestrian mode
2. For dynamic mode
3. For sports mode
4. Speedometer
5. Speed unit
6. Light icon
7. Bluetooth icon
8. Cruise mode
9. Lock icon
10. Error
11. Battery level

Icon	Icon Name	Icon Description
	Pedestrian mode	The max. speed is 6 km/h, The headlight and taillight flash at the same time after entering pedestrian mode.
D	For dynamic mode	The max. speed is 25 km/h, suitable for general riders.
S	For sports mode	The max. speed is 38 km/h, suitable for general riders.
	Speedometer	Shows the speed of the scooter in real time.
Km/h mph	Speed unit	Steps to change the unit between the Imperial System and the metric one: Hold the handlebar, short press the power speed unit button for 3 times.
	Light icon	The light icon will be on after turning on the light, and it will go out after switch the light off.
	Bluetooth icon	The Icon lights up after the bluetooth connection is successful.
	Cruise mode	Cruise mode is activated automatically the indicates that the scooter has detected an error. Refer to the error code table to find solutions.
	Lock icon	The Icon lights up after the lock is successful.
	Error	The icon indicates that the scooter has detected an error. Refer to the error code table to find solutions.
	Battery level	The battery level is indicated by 5 bars, the last bar flashing indicates a low-battery level.
	Power button	Press and hold the button for 2 seconds to turn the scooter on/off. When the scooter is on, press the button to turn the headlight on/off, and press twice to switch modes.

5. Specifications

Index	Items	US Standard	EU Standard
Basic specs	Model	LE1	
	Unfold dimensions	1165x510x1195 mm	
	Fold dimensions	1165x510x550 mm	
	Net weight	20.8 kg (45.8 lbs)	
Rider	Max. payload	130 kg (286.6 lbs)	
	Required height	130-200 cm	
	Recommended age	14-60 years	
Machine parameters	Max. speed	38 km/h (24 mph)	25 km/h
	Typical range [1]	Approx. 56 km	
	Max. slope [2]	Approx. 36%	
	IP rating	IP56	
	Charging time	Approx. 9 h	
	Operating temperature	-10°C ~ 40°C	
	Storage temperature	-20°C ~ 45°C	
Battery	BMS management	Over-charge, Over-temperature, Over-discharge, Over-current, Short circuit, Over-voltage	
	Voltage	36-42V	
	Capacity	14.7Ah, 533.16Wh	
Motor parameters	Nominal power	450W*2	
Charger	Input	AC100-240V 50/60HZ	
	Output	42V $\overline{\text{---}}$ 2A	
Other	Brake system	Manual disc brake + Electronic brake	
	Tire size	10 inch Air-filled low rolling resistance tire	

[1] Typical Range test is based on a 75 kg load at a 25°C temperature with tire pressure of 3.5 bar, riding 18 km/h at a constant speed on a flat road test. The actual range may vary depending on the speed, times of start and stop as well as ambient temperature, etc.

[2] Max slope measured under the following conditions: 75 kg load with 80% battery, riding 10 meter at a speed of 10 km/h from the bottom slope to the top at a speed greater than 6 km/h.

6. Assembly

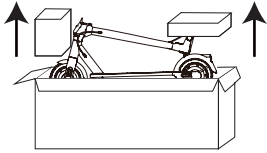

1. Take out the inner tray and scooter.

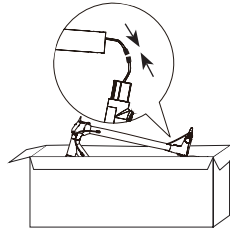

2. Connect the wires inside the handle and the stem as illustrated. Be aware of the correct orientation.

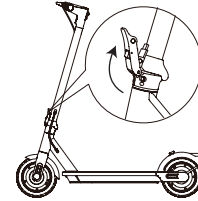

3. Unfold the stem and firmly fasten the folding wrench.

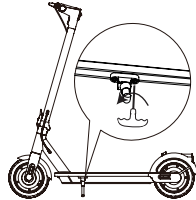

3. Assemble the kickstand with a M5 hex key included in the packing box.

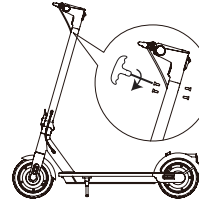

5. Tighten the 4 screws on stem with a M3 hex key included in the packing box.

WARNING

- Please carefully check whether the items in the packing box are complete and intact, if there is any part missing or damaged, please contact us: service@imscv.com.
- To avoid personal injury, please follow the instructions shown in the diagram for assembly operation and inspection.
- Children are not allowed to conduct assembly operations.
- Please retain the box and packaging materials at least 30 days in case you need to ship your scooter in the future.

7. Folding

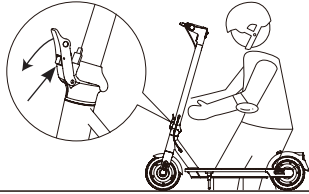

1. Power off the scooter, hold the stem, press the locking button and pull the lever, bend the handlebar stem towards the footrest.

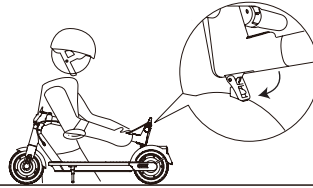

2. Hold the stem and pull the folding ring, attach the hook to the locking clip on the side of the mudguard.

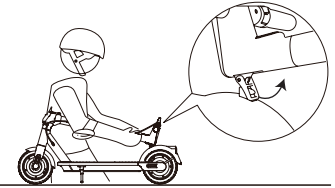

3. Pull the folding ring to unfold the scooter, then right the stem.

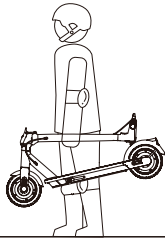

4. Carry the scooter with one hand holding the handlebar stem.

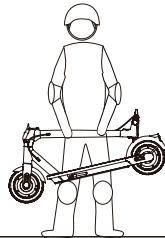

5. Carry the scooter with both hands holding the handlebar stem.

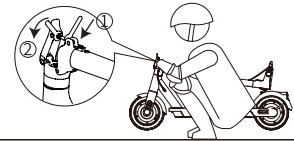

6. When the folding mechanism became loose, tighten up the connecting rods with provided S6 wrench. Then screw up the nuts on folding lever with S10 wrench.

8. Inflating the Tires

For better riding experience, always check the tire pressure before each ride. Please inflate in time if the tires of the device are deflated. The ideal pressure ranges between 2.5 and 3.5 bar.

Note:

The range and riding experience are related to the tire pressures. When the tire pressure is within normal range, the higher the tire pressure is, the longer the range will get.

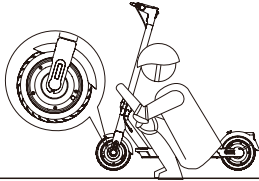

1. Unscrew the air valve caps of tire.

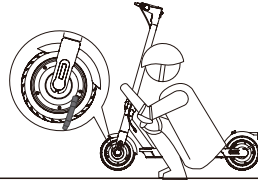

2. Thread the valve extender completely onto the valve stem and tighten it firmly.

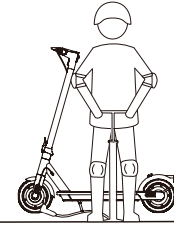

3. Attach the air pump, then inflate the tire to the proper pressure.

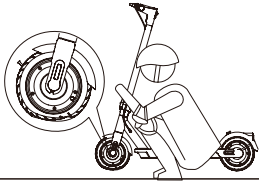

WARNING: Replace the inner tube when the tyre is punctured.



Scan to check how to
inner tube replacement

9. Charge Your Scooter

Charging indicator light: Red (charging)
Green (charged)

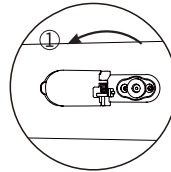
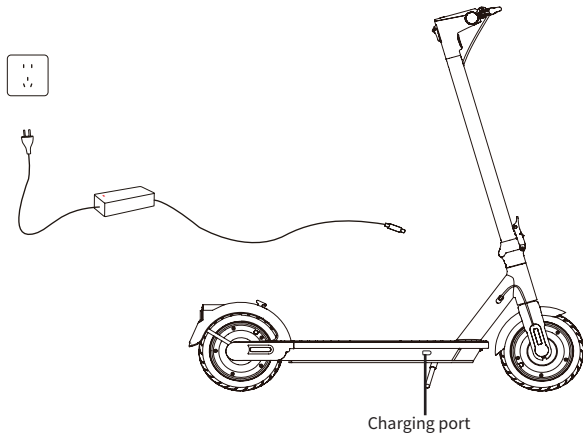

1. Open the rubber cap.

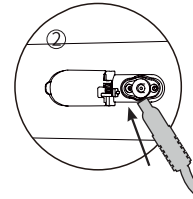

2. Insert the battery charger plug.

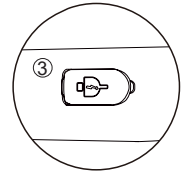

3. Remove the battery charger and close the rubber cap when charging finished.

WARNING

- Do not charge if the charge port or power cord is wet.
- Use only with the original charger, do not use battery packs of other models or brands.
- Do not charge or stop using the battery immediately if it is damaged or flooded.
- Please close charge port cover tightly when not in use or after charging.
- Never charge indoors.

10. First Ride



Download the App via methods below

1. Scan the QR Code on the left.
2. Search " INMOTION " on  or .
3. Directly visit: www.inmotionworld.com/support/app



1. Download and install the App, register/login your account.

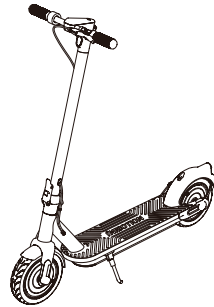

2. Power on the scooter, pair your scooter with the INMOTION App. The scooter will beep when the connection is successful.

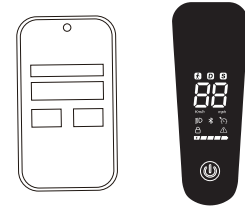

3. Follow the App instructions to activate the scooter and learn how to ride safely. You can now start to use your scooter.

WARNING

There are safety risks when learning to ride the scooter. For your safety, your new scooter is not activated and will beep occasionally after Power ON. Until activated, the scooter maintains a riding speed at 5 km/h and is not allowed to switch the ride modes. Please download INMOTION App to activate your scooter to enjoy all features.

11. How To Ride

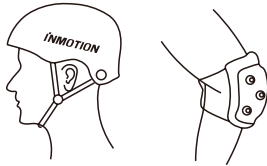

Wear an approved helmet, elbow pads, knee pads and other protective gear to minimize any possible injury.

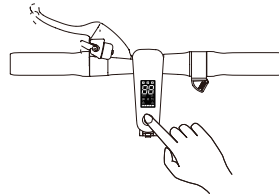

Check the power level indicator after powering on. Charge the scooter if the battery level is low.

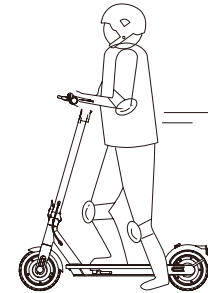

Stand on the footrest with one foot and push off with another foot to start gliding.

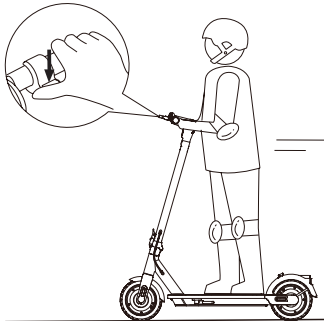

Stand on the footrest with both feet, press the throttle on the right hand. (Note: For your safety, the motor will not engage until the scooter reaches 3 km/h.)

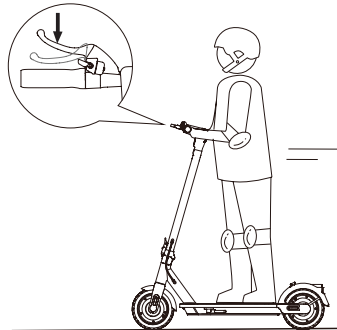

Slow down by releasing the throttle and hold the braking lever lightly (Do not brake suddenly and watch out for the road conditions!).

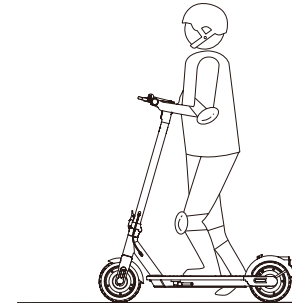

When the car stops or slides slowly, put down one foot and get off.

12. Security Tips



⚠ Do not ride the scooter in the rain.

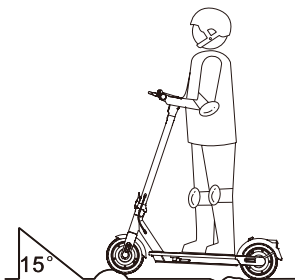

⚠ Do not ride at high speed when you get over speed bumps, thresholds etc., please ride at low speed on rough roads.

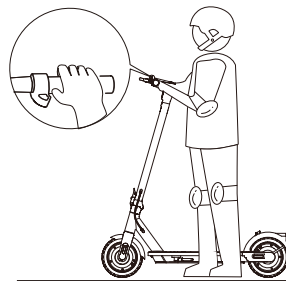

⚠ Do not press the throttle when walking with the scooter.

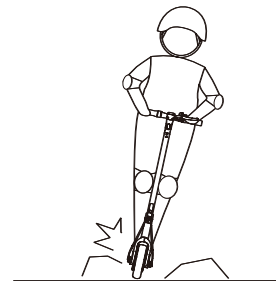

⚠ Avoid contacting obstacles and watch out for the road conditions.

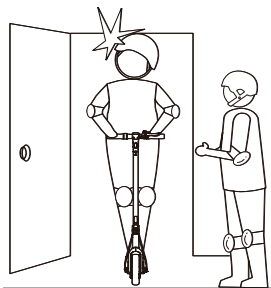

⚠ Watch your head when passing through doorways.

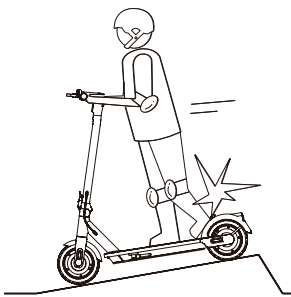

⚠ Do not step on the rear fender.

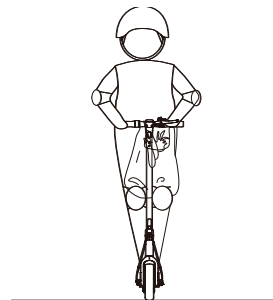

⚠ Do not carry heavy objects on the handlebar.



⚠ Do not ride the scooter with only one foot or one hand.

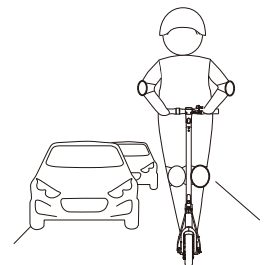

⚠ Do not ride on motorways, public roads, or highways.

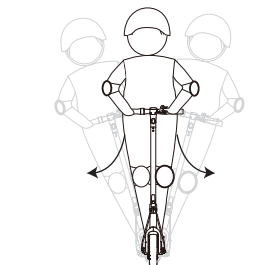

⚠ Do not rotate the handle violently while driving at high speed.

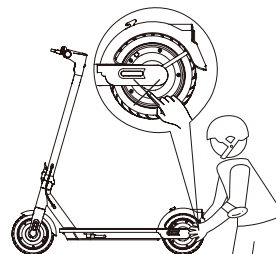

⚠ Do not touch the motor, it may overheat after running.



⚠ Do not take your hands off the handlebar while riding.



⚠ Do not ride through puddles, Please go around at low speed.

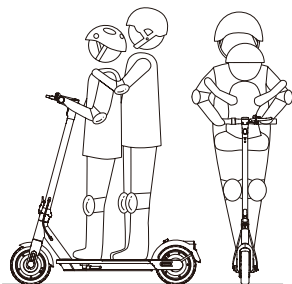

⚠ Do not carry any passengers especially a child. Do not ride when pregnant.

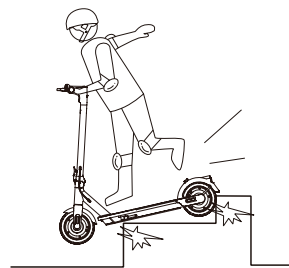

⚠ Do not ride up and down stairs or jump over obstacles.



⚠ Do not use mobile phone or wear earphones when riding the scooter.

13. Fault Code Messages

When your scooter encounters any failure, the dashboard will display the relevant fault code as shown. If the following solutions still fail to solve the problem, please ask the after-sales service for help.

Code	Description of Fault Content	Solution	Components
01	Controller error	Controller error, please restart the vehicle or contact after-sales service for replacement.	Controller
02	Hall error	Motor error, contact after-sales service for motor replacement.	Motor
03	Battery error	Battery error, contact after-sales service for battery replacement.	Battery
04	Battery low voltage	The battery voltage is low, please charge now.	Battery
05	Battery high voltage	The battery voltage is too high, please stop using and contact after-sales service for support.	Battery
06	Brake self-test failure	The brake handlebar is unreleased. Release the brake handlebar or check condition of the throttle.	Brake
07	Throttle power-on self-test failure	The throttle is unreleased. Release the brake handlebar or check the condition of the throttle.	Throttle
08	/	/	/
09	Dashboard communication error	Please restart the vehicle or contact after-sales service for replacement.	Dashboard
10	Controller communication error	Please restart the vehicle or contact after-sales service for replacement.	Controller
11	Mos overheating	Controller board overheating, stop riding and wait for it to cool down.	Controller
12	Mos overheating	Controller board overheating, stop riding and wait for it to cool down.	Motor

14. Maintenance

Cleaning

Wipe the body of the scooter with a damp cloth. If stains persist, apply some toothpaste, brush with a toothbrush, then wipe with a damp cloth.

Note

- When cleaning the scooter, make sure that it is turned off, that the charging cable is disconnected, and the rubber cap is closed, as a water leak may cause a damage to electronic components.
- Do not clean the scooter with alcohol, petrol, kerosene or other corrosive and volatile chemical solvents, to avoid serious damage.
- Do not wash the scooter with jets of high pressure water.

Charging precautions:

- Do not charge the scooter in wet environment.
- The best ambient temperature for charging is -10°C ~ 40°C .
- Keep out of reach of children and animals, keep away from flammable materials while charging.
- Do not store the scooter in environments with a temperature ranging from -20°C to 45°C . Do not put the battery pack into the fire. Doing so may cause fire, heat generation, leakage or bursting.
- After each use, fully recharge the battery to extend its useful life. Completely draining the battery may permanently damage the battery.
- Do not charge or use the battery if it smells, overheats or leaks.
- Do not open the battery pack or insert anything into the charging port as it contains hazardous substances.
- Please only use the original battery and adapter for your scooter.
- Always comply with local environmental protection laws about battery recycling.

Storage

When the scooter is not in use, store it in a cool, dry place. Do not store it outdoors for extended periods of time.

Note

Excessive sunlight, overheating, and excessive cold accelerate tire ageing and jeopardize the life of both the scooter and the battery.



WARNING

- Only use original batteries, as other models or brands may pose a safety risk.
- Please do not exceed the specified temperature for battery storage or charging. (see specifications)

- Do not touch the battery contacts. Do not dismantle or puncture the outer casing. Avoid contact between metal objects and battery terminals to prevent short circuits, physical harm or death.
- Do not throw the battery into a fire as this could damage it, cause overheating or even a fire.
- Do not charge or stop using the battery if it is damaged or flooded.
- Do not attempt to remove the battery as you may damage the scooter.
- Do not attempt to disassemble the battery to prevent fire hazards. Users are now not allowed to repair spare parts and components come with the scooter.
- Do not ride when the ambient temperature is higher than the operating temperature of scooter (see Specifications) because low/high temperature will limit the maximum power/torque. Doing so could cause personal injury or property damage due to slips or falls.
- After each use, fully recharge the battery to extend its service life. Completely draining the battery may permanently damage the battery.
- Improper disposal of used batteries seriously pollutes the environment. Follow local regulations regarding battery disposal. Follow battery disposal regulations to protect the environment.

Typically, a fully charged battery should retain power for 120-180 days. A low-power battery should retain power for 30-60 days. Remember to recharge it every 90 days to protect it from any damage. Electronics inside the battery record the charge-discharge condition of the battery, damage caused by over-charging or under-charging will not be covered by the limited warranty.

A well-maintained battery can perform well even after many miles of riding. When used at room temperature 25° C, the battery range and performance is at its best; whereas using it at low temperatures can decrease range and performance. Battery range will recover when temperature rises.

15. Before Your Ride

1. Read the product instructions carefully and do not attempt to ride the scooter if you cannot follow the instructions completely.
2. Please do not allow others to use your scooter without carefully reading this instruction or knowing how to use this product and safety precautions.
3. All parts of the scooter must be properly installed in accordance with the instructions. Improper installation may result in the risk of loss of control, collision or fall. Before installation or maintenance, please power the scooter off, install the components with proper strength. Too loose or too tight installation may cause damage or failure of the products.
4. Please purchase insurance in time after purchasing the product to minimize the risk.
5. Before each ride, please check all vehicle components are in place and securely fastened, the performance of wheels, the battery level, running condition, etc., to ensure any parts including the handlebar, stem, tires, brakes, screw are not loose or damaged, and the vehicle is in good condition for riding. If you've noticed anything unusual, please stop using immediately and contact after-sales service for technical support.
6. You are obligated to be aware of all laws, regulations and policies of scooter riding in your area and to strictly comply with the applicable laws, regulations and policies.

16. Environmental Protection

This product contains battery or recyclable electronic waste, and the built-in rechargeable battery contains substances that may pollute the environment. When disposing of the product, please do not pile it with general household waste, but hand it to the electronic waste collection point designated by the state, which is beneficial to environmental protection.

17. Certifications

For model: LE1

The battery complies with UN/DOT 38.3.

FCC ID: 2ADUSLE1

Federal Communications Commission (FCC) Compliance Statement for USA:

This device complies with part 15 of the FCC rules. Operation is subject to the following two conditions: (1) This device may not cause harmful interference, and (2) this device must accept any interference received, including interference that may cause undesired operation.

Note:

This equipment has been tested and found to comply with the limits for a Class B digital device, pursuant to part 15 of the FCC Rules. These limits are designed to provide reasonable protection against harmful interference in a residential installation. This equipment generates, uses and can radiate radio frequency energy and, if not installed and used in accordance with the instructions, may cause harmful interference to radio communications. However, there is no guarantee that interference will not occur in a particular installation. If this equipment does cause harmful interference to radio or television reception, which can be determined by turning the equipment off and on, the user is encouraged to try to correct the interference by one or more of the following measures:

- Reorient or relocate the receiving antenna.
- Increase the separation between the equipment and receiver.
- Connect the equipment into an outlet on a circuit different from that to which the receiver is connected.
- Consult the dealer or an experienced radio/TV technician for help.

This equipment complies with FCC radiation exposure limits set forth for an uncontrolled environment.

Restriction of Hazardous Substances (RoHS) Directive

INMOTION TECHNOLOGIES CO., LTD. product, with included parts (cables, cords, and so on) meets the requirements of Directive 2011/65/EU on the restriction of the use of certain hazardous substances in electrical and electronic equipment ("RoHS recast" or "RoHS 2").

Radio Equipment Directive



Hereby, INMOTION TECHNOLOGIES CO., LTD. declares that the radio equipment type is in compliance with Directive 2006/42/EC.

Bluetooth	Frequency Band(S)	2.4000-2.4835GHz
	Max. RF Power	100mW

18. Trademarks and Legal Notices

INMOTION is a registered trademark of INMOTION TECHNOLOGIES CO., LTD; Android, Google Play are trademarks of Google Inc., App Store is a service mark of Apple Inc., The respective owners reserve the rights of their trademarks referred to in this manual.

We have attempted to include descriptions and instructions for all the functions of the scooter at the time of printing. However, due to constant improvement of product features and changes of design, your scooter may differ slightly from the one shown in this document. The manufacturer reserves the right to change the design and functionality of the scooter product and documentation without prior notice.

19. Contact US

Contact us if you experience issues relating to riding, maintenance, and safety, or errors/faults with your scooter.

INMOTION TECHNOLOGIES CO., LTD.

Address: 18/F, B1, Nanshan iPark, No.1001 Xueyuan Ave., Nanshan, Shenzhen, China

Tel: 4000100012 ext.8015

E-mail Service: service@imscv.com

E-mail Amazon USA Service: AmazonService@imscv.com

Website: www.inmotionworld.com

INMOTION App: Me → Online Service.

Note:

Write your scooter serial number on hand when contacting INMOTION.

You can find your serial number next to the deck of the scooter or in the App under “Vehicle Management” → “About Vehicle”.



INMOTION App



Facebook Group



Website