









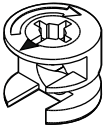
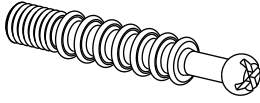
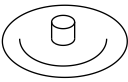
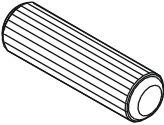
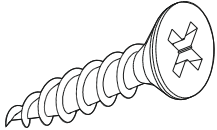
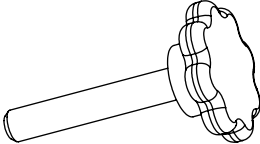

PRODUCT NAME	MVN1 CAR BED	  
MODEL NUMBER	SLAT SYSTEM	
ASSEMBLY INSTRUCTIONS		PAGE: 4/1

			
A 	B 	C 	D 
MINIFIX NUT x4 pc.	MINIFIX STUD x4 pc.	MINIFIX WHITE PLUG x4 pc.	DOWEL x4 pc.
E 	F 	G 	
YSB SCREWS M5x30 x28 pc.	BUTTERFLY BOLT M6 x4 pc.	YSB SCREWS M6x12 x4 pc.	
H 	I 		
SLAT'S SUPPORT STEEL x1 pc.	SLAT'S SUPPORT x4 pc.		
K 			
SLATS x14 pc.	SPOILER x1pc, SPOILER HOLDER x2pc, REMOTE CONTROL x1pc, ADAPTOR x1pc		
L 	M 		
3x18 BACKREST SCREW x6 pc.	YSB M6x12 SCREW x4 pc.		
ASSEMBLY INSTRUCTIONS			PAGE: 4/2

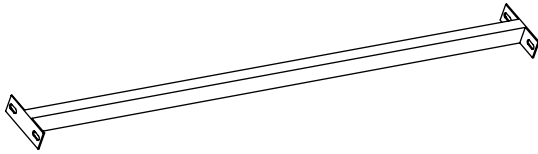
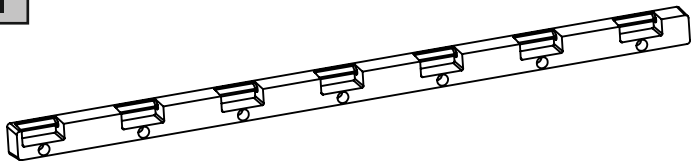
1

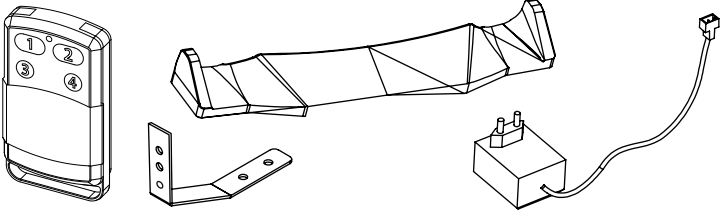
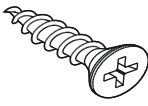

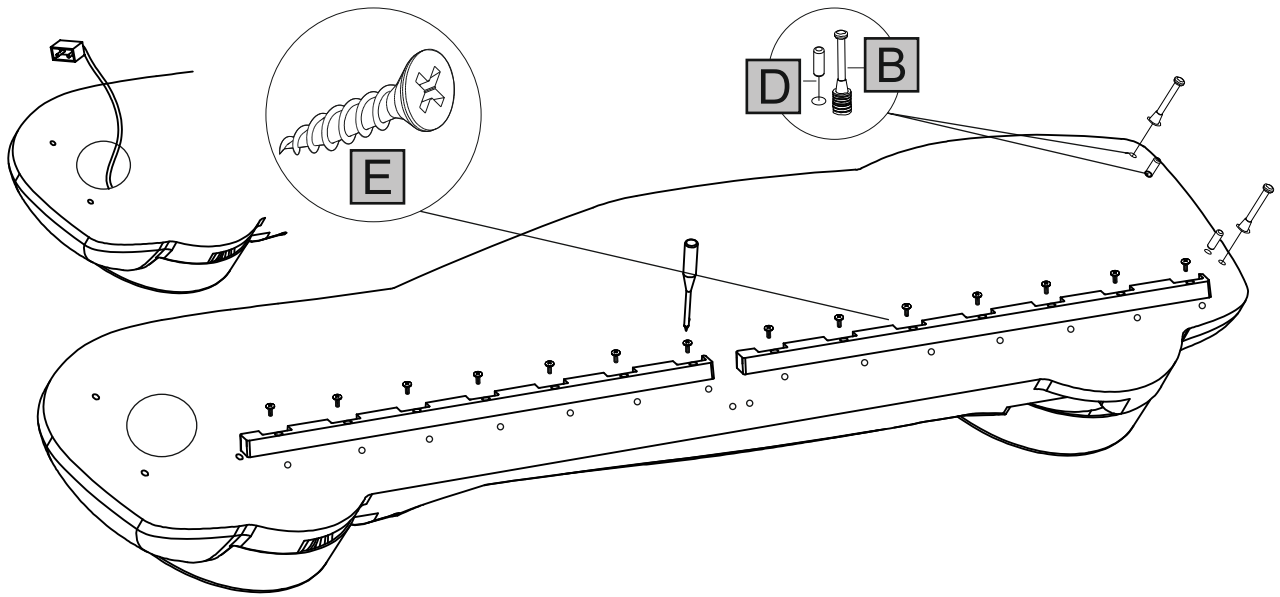
2

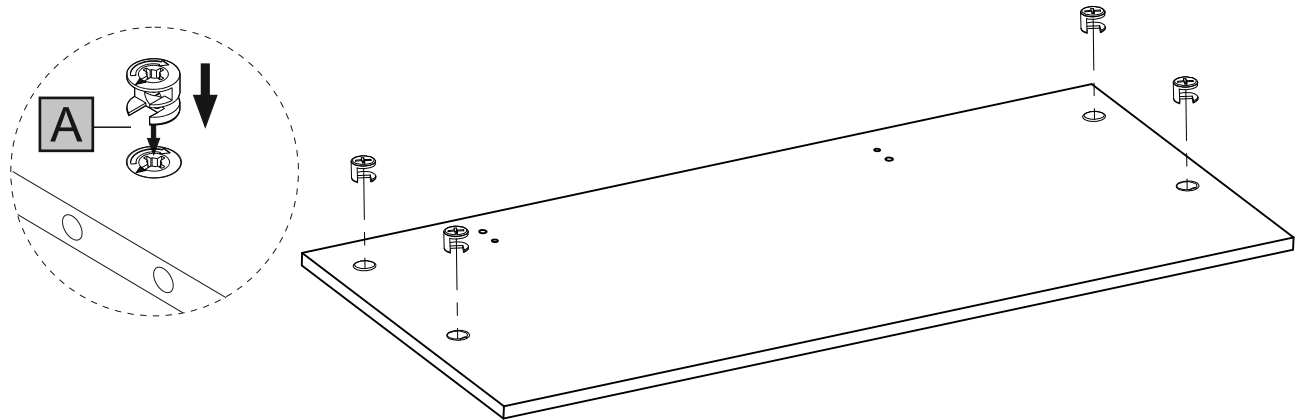

3

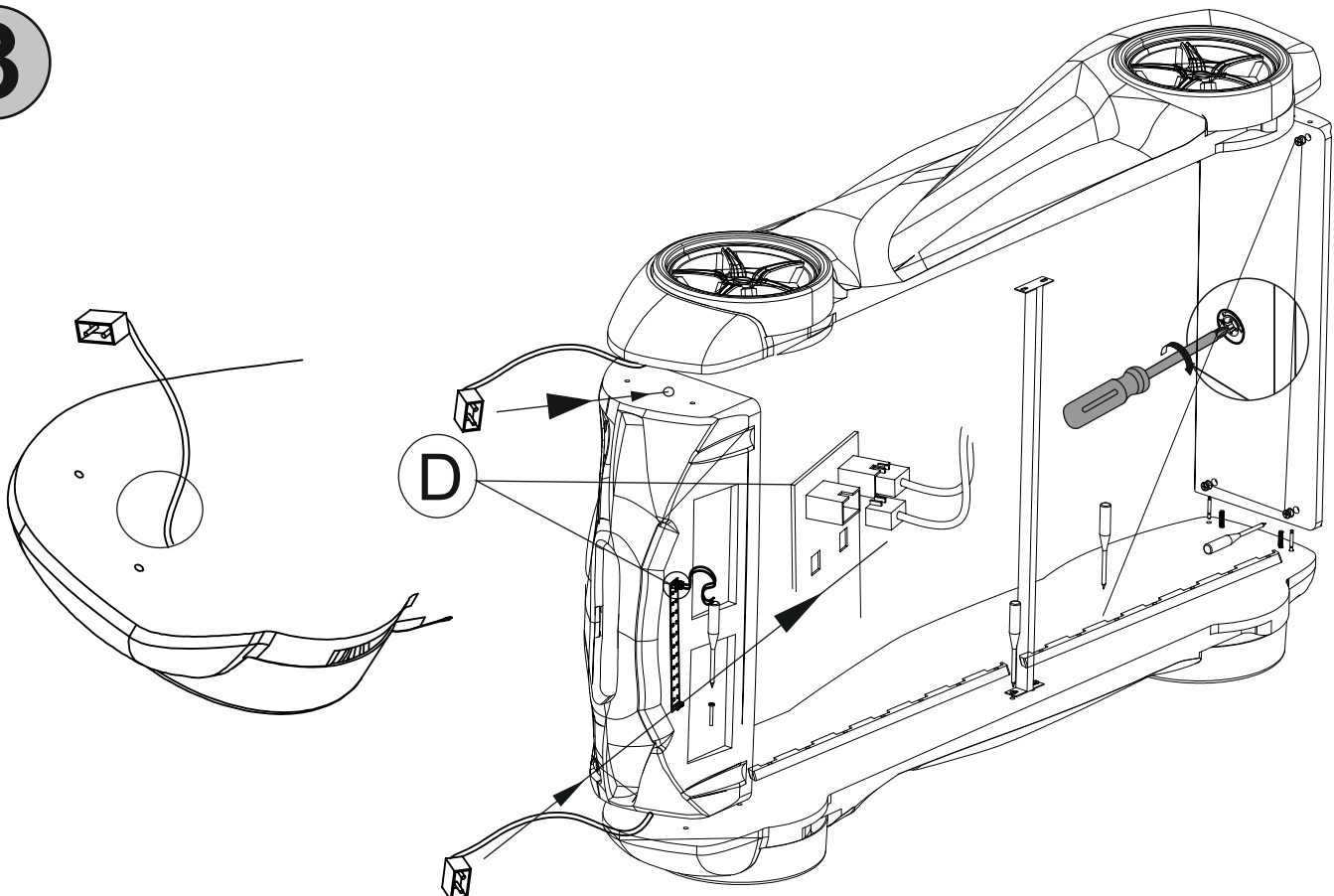

4

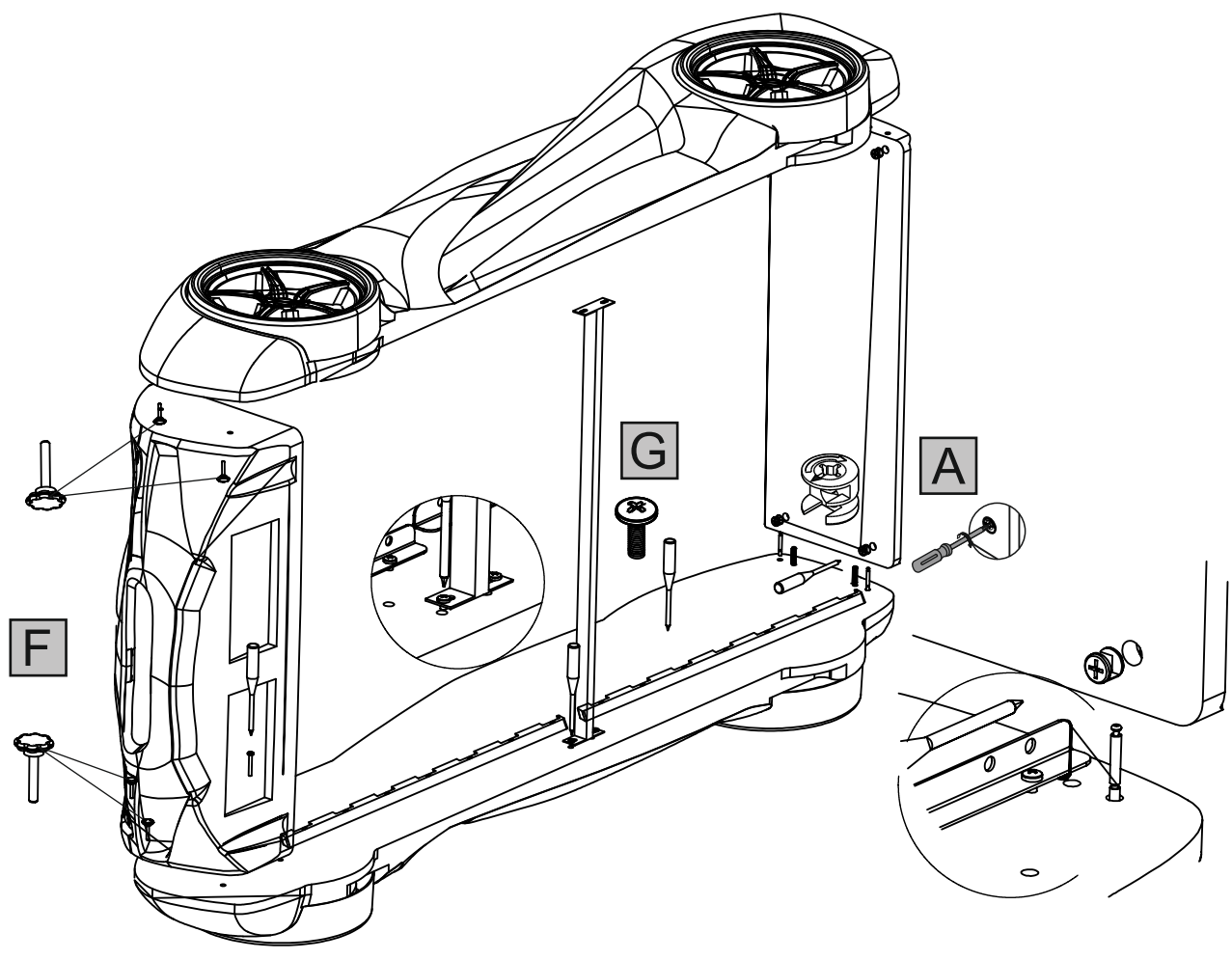

5

