



**UK RETAIL  
PRICE BOOK**

**APRIL 1, 2024**

# TABLE OF CONTENTS

## USB Digital-Audio Converters

DragonFly DAC	7
JitterBug FMJ USB Noise Filter	7
USB Extenders and Adaptors	7

## AC Power

Power Conditioners	9
Power Cables	11-12
Power Plugs	12
Adaptors	14
Fog Lifters (Cable Risers)	14

## Speaker Cables

Q2	18
Type Series	18
Rocket Series	19
Folk Heroes	20-21
Mythical Creatures	22-24
BiWire Jumpers	25
Fog Lifters (Cable Risers)	25
Binding Post Wrench	25

## Audio Interconnect Cables

Bridges & Falls	27
Rivers & Mythical Horses	28
Mythical Creatures	28
Adaptors, Splitters, Couplers	30
PreAmp Jumpers	30

## Subwoofer Cables

31

## Tonearm & Turntable Cables

33

## Vinyl Accessories

GroundGoody Tonearm & Ground Wires	35
Record Brushes	35

## Headphone Accessories

Headshell Leads	35
NightBird Headphone Cable	35
Headphone Plug Adaptor	35
Perch Headphone Stand	35

## HDMI Cables

8K (48Gbps)	38
4K (18Gbps) & 8K (48Gbps) Long-Length	39
8K (48Gbps) eARC-Priority	39
Adaptors, Coupler	40

## Digital-Audio Interconnect Cables

USB Cables and Adaptors	41-43
Optical Cables and Adaptor	44
Digital Coax Cables and Adaptor	45
AES/EBU (Balanced) Cables	46
Ethernet Cables (RJ/E)	47

## Accessories

DBS Pack	48
Q-Feet System	48
Fog Lifters (Cable Risers)	48
CleanScreen	48
Sorbothane Self-Stick Sheet	48
Binding-Post Wrench	48
Adaptors, Splitters, Couplers	49
Antenna Cables - HD6 Forest	49
RCA, XLR, Coax	
Plugs and Connectors	50
Noise-Stopper Caps	51

## Tools

Crimp Tools, Cable Cutters, and Wire Strippers	52
Silver Solder	52

## Instant Tool-less Connectors (ITC)

Cable Stripper	53
Bulk Cables	53
Connectors	53

## Bulk Speaker Cables (Spools)

CL3/FT4 In-Wall Rated Speaker Cables	54
Speaker Cables — Not In-Wall Rated	55
SureGrip® Speaker Connectors	56
Spade, Pin, and Banana Connectors	57
Termination Pants	57

## Bulk Audio Interconnect Cables (Spools)

CL3/FT4 In-Wall Rated Audio Interconnect Cables and Plugs	58
--	----

## Bulk Ethernet Cables (Spools)

CL3/FT4 In-Wall Rated CAT6 and CAT7 Ethernet Cables & Plugs	59
--	----

## Installer Packs

Cables, Splitters and Adaptors in Single, Packs of 5 and 10	60-61
--	-------

## POP Materials

Wall Signs, Tent Card, Window Sticker	62
Spool Holder	62
In-Store Display Racks	62

## Promotional Items

Polo, T-shirt, Jacket	63
Baseball Cap, Beanie	63
Pen	63
Tumbler, Water Bottle	63
License Plate Frame	64
Backpacks, Tote Bag	64

## Index

65-66

## April 2024 Price Book Updates

- [Added Golden Gate Tonearm Cable](#)
- [Added Black Hole GroundGoody](#)
- [Added Silver Anti-Static Record Brush](#)
- Renamed Super-Conductive Anti-Static Record Brush to Gold Anti-Static Record Brush
- Removed DragonFly Black & Red
- Updated Wild & WEL AES/EBU to remove DBS feature
- Removed Diamond AES/EBU
- Updated SLiP Cables Gauge descriptions

## Terms and Conditions

- Prices are subject to change without notice.
- All prices are in Pound Sterling.
- As used throughout this price book, “Retail” carries the same meaning as Suggested Retail Price (SRP).

## Returns

- All returns are subject to approval by AudioQuest.
- Built-to-order products may not be returned.
- All sales are final for custom speaker cables produced at 2m or less.
- A Return Merchandise Authorization (RMA) number must be issued by AudioQuest before any product may be returned.
- The RMA number must appear on the outside of the shipping carton, near or on the address label.

## Contact Information

AudioQuest  
Hoge Bergen 10  
4704 RH Roosendaal  
The Netherlands  
www.audioquest.com  
Tel: 01249 848873

Email orders and related correspondence: [orders@audioquest.nl](mailto:orders@audioquest.nl)

Email all other correspondence to: [info@audioquest.nl](mailto:info@audioquest.nl)

Copyright © 2024 AudioQuest.  
All rights reserved.  
E & OE. In the interests of continuous product improvement, all specifications are subject to change without notice.

## AudioQuest: Doing No Harm Since 1980



**William (Bill) Low**  
Founder / CEO

For 44 years now, AudioQuest, headquartered in Irvine, California, has been a leading developer, manufacturer, and distributor of high-performance audio/video products and custom-install solutions. Although best known for our comprehensive range of analog, digital, and AC power cables, our portfolio has expanded to a diverse assortment of products, including the multi-award-winning DragonFly DACs, LYRA, and Niagara and PowerQuest power products.

Our ultimate goal is the same today as it was 44 years ago: Do No Harm! By this we mean that all cables and components, to the extent that is technologically feasible, should get out of the music's way by inducing the least amount of noise and distortion.

### The Evolution Continues: The Four Elements Today

While minimizing noise and damage to the audio signal remains the North-Star constant, the ways in which AudioQuest engages these challenges always evolves. While there are still Four Elements that describe our foundational materials and design philosophies, a growing number of technologies cross and even go beyond our original Four Elements. Many have become crucial enough to demand visibility. Noise-Dissipation is an umbrella Element under which many of these meaningful techniques and technologies will reside. While Geometry is no longer identified as one of The Four Elements, it remains inextricably tied to all other Elements of cable design and manufacture.

**Solid Conductors:** Strand interaction remains the biggest potential source of distortion in cables. Solid Conductors are the aspirational ideal and most complete solution to this problem. However, thoughtfully arranged multi-conductor geometries such as concentric windings are used to create our Semi-Solid Conductor technologies. These avoid many strand-distortion mechanisms and are in their own right ideal in a growing number of applications.

**Directionality:** All drawn metal conductors have a non-symmetrical, fish-scale-like grain structure. Because the highest Radio Frequencies (RF) are subject to skin effect, traveling on this deformed outer-surface layer of the conductor, there is a resulting increase in RF impedance in one direction versus the other. Since induced RF noise is parasitic (and doesn't travel with the primary signal current), it takes the path of least resistance. At AudioQuest, we test every conductor so it is used in the direction that drains the induced noise away from where it will cause the most harm, optimizing the cable and the system's performance.

**Noise-Dissipation:** Unwanted Radio-Frequency (RF) noise is and has always been picked up and induced into cable. This contamination ultimately masks and distorts critical portions of the audio/video signal. As this distortion-causing (parasitic) RF signal is more present today than at any previous time in history, we must depend on a wider arsenal of Noise-Dissipation technologies:

- ZERO-Tech (No Characteristic Impedance) applies Ultra-Linear Noise-Dissipation across the widest range of frequencies possible. It also enables uncompressed transient current transfer for AC power and loudspeaker/power amplifier applications.
- RF/ND-Tech (Patented Radio-Frequency Ground-Noise Dissipation) minimizes circuit misbehavior by cancelling induced RF noise.
- Tried-and-true DBS (Dielectric-Bias System) has evolved to include RF-Noise Traps that further reduce dielectric distortion and induced noise.

**Metal Quality:** Higher-purity conductor metals with smoother surfaces and internal crystal structures greatly reduce noise and distortion. Carefully finessed mixes of metals and conductor sizes can be effectively used to define a cable's Sonic Signature—a cost-effective technique for high-value, high-performance models.

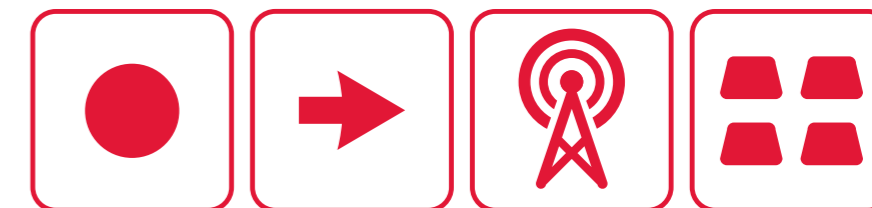

**Solid Conductors**   **Directionality**   **Noise-Dissipation**   **Metal Quality**

# DragonFly

## Naturally Beautiful Sound at Your Fingertips—Whenever and Wherever You Want It

With today's smartphones, tablets, and computers, music and videos are far more accessible than ever before.

Unfortunately, the digital-to-analog converters (DACs) inside these devices are highly compromised, even when the sample-rate numbers (24/192, etc.) look impressive. These built-in DACs may make audible sound, but they don't make beautiful music.

A DragonFly bypasses the compromised audio circuitry within these devices to deliver naturally beautiful sound to earbuds, headphones, desktop speakers, or complete audio systems.

Whether using a free streaming service, premium High-Resolution or MQA-encoded streaming (such as Tidal Masters), or playing MP3 files or videos, all DragonFlies make these experiences much more compelling and immersive.

DragonFly Black delivers great performance and value. Red ups the game with more power, more grip, and deeper sonic immersion. Now, DragonFly Cobalt, with its more advanced processor, microcontroller, and RF noise filtering, provides even greater clarity, dynamics, and finesse than previously possible.



## DragonFly Cobalt DAC + Preamp + Headphone Amp

- Plays all music files: MP3 to High-Res and MQA
- Compatible with Apple® and Windows® PCs
- Compatible with iOS devices (requires Apple Lightning to USB 3 Camera Adaptor)
- Compatible with Android devices (requires DragonTail or other USB Adaptor for Android Devices)
- Bit-perfect variable output drives headphones, powered speakers, or power amp
- Fixed output feeds preamp or receiver



	DragonFly Cobalt
<b>Output</b>	2.1 volts
<b>DAC Chip</b>	ESS ES9038Q2M DAC chip with minimum-phase slow roll-off filter for more natural sound
<b>Volume Control</b>	64-Bit Bit-Perfect Digital Volume Control
<b>Desktop Compatibility</b>	Windows 7 and later; Apple 10.6.8 and later; Linux (no tech support provided)
<b>Mobile Compatibility</b>	Apple iOS 5 and later; Android 5.0 and later
<b>Included Adaptor</b>	DragonTail A to C Adaptor
<b>Accessories</b>	Protective Endcap, Leatherette Pouch
<b>Dimensions</b>	57mm (l) x 19mm (w) x 12mm (h)
	<b>UK Retail: 179.95</b>

## USB Extenders and Adaptors

DragonTail USB Extenders feature 5% Silver Solid Conductors and are Direction-Controlled for reduced RF noise.



**DragonTail USB A 2.0 Extender**  
Female USB A to Male A  
**UK Retail: 25.95**



**DragonTail USB A to Micro Adaptor**  
Female USB A to Male Micro  
**UK Retail: 25.95**



**DragonTail A to C Adaptor**  
(included with DragonFly Cobalt)  
**UK Retail: 25.95**

## JitterBug FMJ USB 2.0 Noise Filter (Data & Power)

- Enables more spacious and compelling sound
- Dual Discrete Noise-Dissipation Circuits reduce all forms of internal noise in both the sending and receiving electronics
- Full Metal Jacket (FMJ) with hinged Carbon-Loaded Noise-Dissipation input cover protects against external noise
- Reduces jitter and packet errors
- Use one JitterBug in series with almost any USB DAC, including DragonFlies Black and Red; experiment with DragonFly Cobalt
- For an additional improvement, use a second JitterBug in parallel—always desirable with DragonFly Cobalt

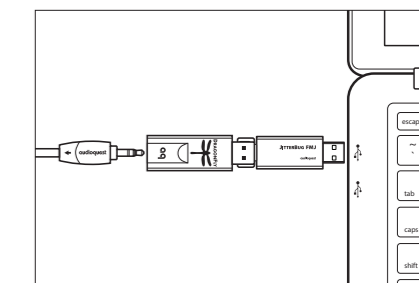

**UK Retail: 59.00**

# AC Power Conditioners

## Niagara and PowerQuest: Low-Z Power | Noise-Dissipation Systems

### Redefining the science of AC power conditioning

What is a power conditioner and why is it necessary?

For some, a power conditioner is merely a device that provides enough outlets for the entire audio/video system while also protecting the connected devices from electrical storms and wiring faults. Yet, for the discriminating listener, many power conditioners can make an audio/video system perform far worse.

Yes, a home or building may have dimming lights or an occasional brown-out, and the utilities' AC sine wave is always far from perfect. However, where incoming power is concerned, there are two reasons an audio/video system does not perform up to its full potential: 1) The current transients that supply the power amplifier are compressed, and 2) The ever-increasing levels of radio-frequency noise are masking (covering up) the system's low-level signal content.

When compared to or measured against either Niagara or PowerQuest, a simple power bar or a dedicated AC wall outlet can lose up to a third of the low-level audio information that contain much of a recording's harmonics, imaging, high frequencies, and bottom-end grip—and once that information is gone, it's gone forever.

AudioQuest's Niagara and PowerQuest technologies are unique amongst all power products—whether they're isolation transformers, AC regenerators, battery back-up, re-clocking devices, or other types. Niagara and PowerQuest filters and Ground-Noise Dissipation work evenly, or linearly, across a far wider range of induced noise frequencies. Additionally, Niagaras 3000, 5000, and 7000 feature Transient Power Correction, which supplies a current reservoir to greatly bolster the performance of any power amplifier.



## Niagara Series AC Power Conditioners

All Niagaras share the following features:

- Linear Noise-Dissipation Technology
- Patented Ground-Noise Dissipation
- Directionally Controlled Wiring & Inductors
- High-Tension AC Inlets and Outlets
- Non-Sacrificial Surge Protection
- Extreme Voltage Shutdown

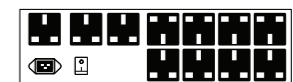
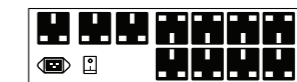

	Niagara 1200	Niagara 3000	Niagara 5000	Niagara 7000
<b>UK Retail</b>	1,099.00	3,399.00	4,999.00	9,399.00
<b>Power Cable</b>	<b>Not Included</b> A direction-controlled cable is required to maximize the Niagara's performance			
<b>Transient Power Correction</b>	No	55 amps peak (up to 25mS)	80 amps peak (up to 25mS)	
<b>DBS Symmetrical Power Isolation Transformer</b>	No			Yes
<b>Outlets</b>	7 total: (5) Source (2) High-Current		11 total: (8) Source (3) High-Current	
<b>Maximum RMS Current</b>	10 Amps (RMS) @ 220 - 240V		16 Amps (RMS) @ 220 - 240V	
<b>Dimensions</b>	493mm W x 81mm H x 190mm D	445mm W x 88mm H x 386mm D (2-RU rack mount kit included)	445mm W x 133mm H x 437mm D (3-RU rack mount kit on request)	445mm W x 133mm H x 437mm D (3-RU rack mount kit on request)
<b>Weight</b>	8.2 kg	11.3 kg	17.2 kg	39 kg

For more information on AudioQuest power products, visit <https://www.audioquest.com/ac-power>

Download our Power Demystified paper at <https://www.audioquest.com/theory-education>

# AC Power Cables

## Low-Z | Noise-Dissipation NRG, Wind, and Storm Series

The power cables that are supplied with most audio/video components have many admirable features. They're durable, flexible, small, and they will unfailingly supply the required AC voltage from the utilities' service tap for many years to come. They're also inexpensive.

Unfortunately, these "commodity" power cables were never up to the task of supplying sensitive components with the quality power they need. By this, we mean power that is unrestricted when delivering current transients to a power amplifier. The power cable must not add noise to the audio/video signal via RF (radio-frequency) noise that is induced into, or picked up by, the AV component. The ground lead is the worst offender in this regard, as it has no component power supply to help lessen the damage from the induced RF noise. Typically, the ground noise drains directly towards the component's signal path.

Even with an advanced AC power system like Niagara or PowerQuest, the AC power cable is a branch of noise-dissipation system. Like plumbing, the RF noise must be drained away from the circuits upon which it could do harm. Many ask, if my wall wiring is so many yards in length, how can a 6-foot cable possibly matter? It matters for the same reason four square inches of mud and debris can back up a plumbing system or a rain gutter. The drainage or distribution of water currents and noise currents work in the exact same manner. They are one system.

With AudioQuest AC power cables and our unique technologies such as ZERO-Tech (No Characteristic Impedance) and our patented RF/ND-Tech, you will experience greater dynamics, bass grip, extended high frequencies, and the blackest background you've ever heard.

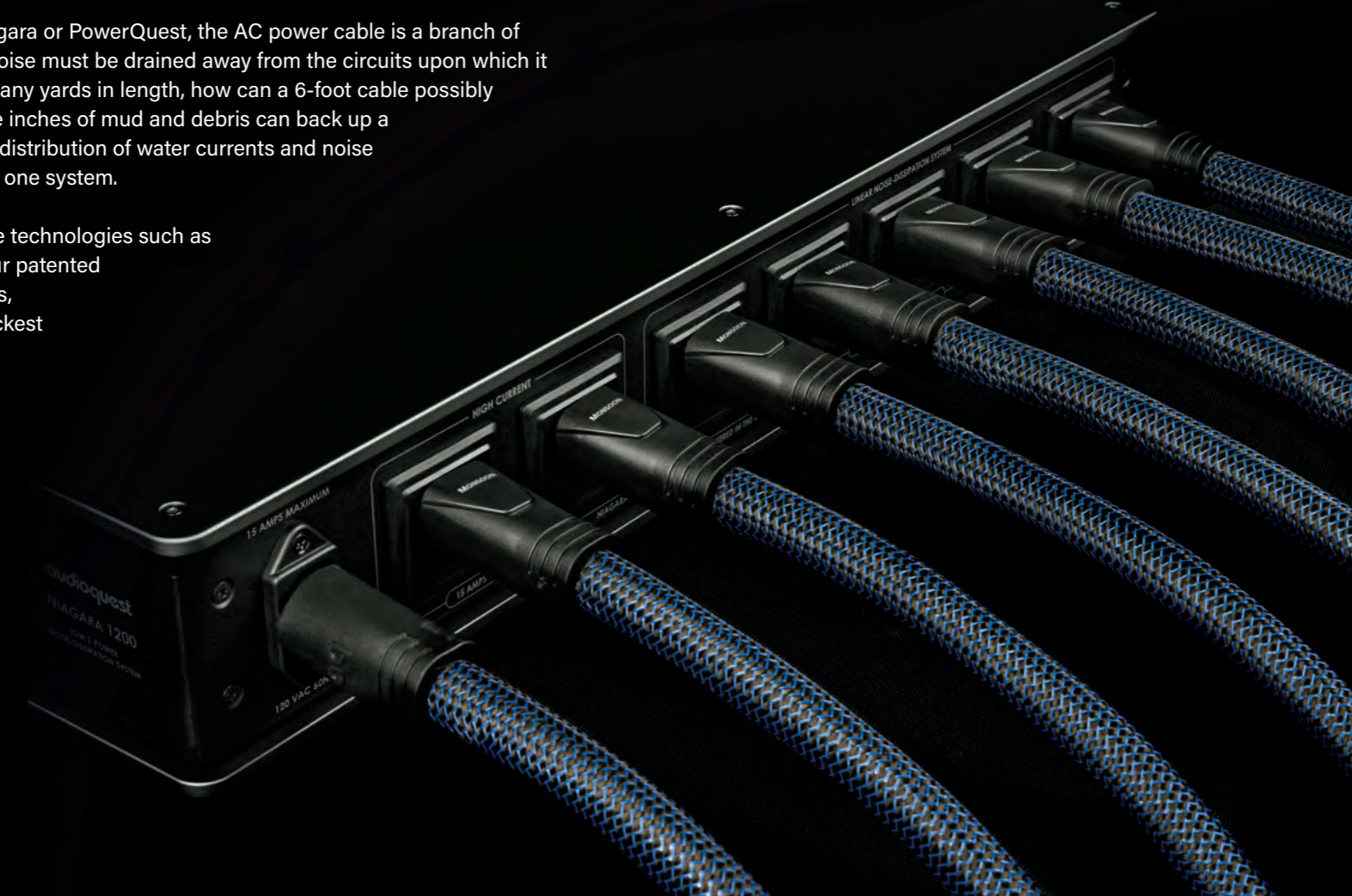

## AC Power Cables: NRG Series

**C5**  
2.5A Maximum RMS Capacity @ 230VAC 50Hz



**C7**  
2.5A Maximum RMS Capacity @ 230VAC 50Hz



**C13**  
10A Maximum RMS Capacity @ 230VAC 50Hz



NRG-Y2 and NRG-Z2 cables use a 2-prong C7 connector—and yet feature a 3-prong wall plug. The additional ground connection is necessary to enable ZERO-Tech, and to maximize RF-Noise Dissipation.



Model	NRG-X2	NRG-Y2	NRG-Z2	NRG-X3	NRG-Y3	NRG-Z3
<b>Metal</b>	Semi-Solid Concentric LGC		Semi-Solid Concentric PSC+	Semi-Solid Concentric LGC		Semi-Solid Concentric PSC+
<b>Gauge</b>	1.04mm <sup>2</sup> (2.5 Amp @ 220-240V)			1.31mm <sup>2</sup> (C13 Plug: 10 Amp @ 220-240v, C5 Plug: 2.5 amps @ 220-240v)	2.08mm <sup>2</sup> (10 Amp @ 220-240v)	2.08mm <sup>2</sup> (10 Amp @ 220-240v)
<b>Technology</b>	-	ZERO Tech (No Characteristic Impedance)		-	ZERO Tech (No Characteristic Impedance)	ZERO Tech (No Characteristic Impedance); Patented RF/ND-Tech
<b>Jacket</b>	Black PVC with Red Stripes	Dark Gray/Black Braid	Dark Red/Black Braid	Black PVC with Red Stripes	Dark Gray/Black Braid	Dark Red/Black Braid
<b>Terminations</b>	Cold-Welded Connectors					
<b>Length</b>	<b>UK Retail</b>	<b>UK Retail</b>	<b>UK Retail</b>	<b>UK Retail</b>	<b>UK Retail</b>	<b>UK Retail</b>
<b>1m</b>	64.95	124.95	179.00	79.95	134.95	224.00
<b>2m</b>	79.95	149.95	229.00	99.95	169.95	309.00
<b>3m</b>	94.95	174.95	279.00	119.95	204.95	394.00
<b>4.5m</b>	-	-	-	149.95	-	-
<b>6m</b>	-	-	-	179.95	-	-



**C17**  
For components that use the ungrounded C17 connector, please use AQ cables with a C13/C15 connector. The grounded male plug is necessary to make use of our Noise-Dissipation System.

Note: NRG-X3 with C5 connector is available in 1m, 2m & 3m only

## AC Power Cables: Wind Series

Never assume which of these is required for a component or power conditioner. Some manufacturers prefer the performance of one IEC inlet type over another—even when their circuit's current draw is minimal.

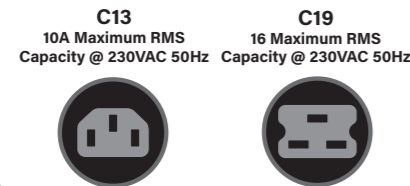

Wind Series Plugs

Wind XTRM Plugs Built From Storm-Level Components

XTRM cables have upgraded plugs equivalent in quality to the Storm Series plugs.

Model	Monsoon	Monsoon XTRM	Blizzard 72v DBS	Blizzard XTRM 72v DBS	Silver Cloud 72v DBS	Silver Cloud XTRM 72v DBS
Plug Type	Direct-Gold Plated Moulded	Hanging-Silver over Red and Beryllium Coppers	Direct-Gold Plated Moulded	Hanging-Silver over Red and Beryllium Coppers	Direct-Gold Plated Moulded	Hanging-Silver over Red and Beryllium Coppers
Metal	Semi-Solid True-Concentric Perfect-Surface Copper+ (PSC+) and Long-Grain Copper (LGC)		Semi-Solid True-Concentric Perfect-Surface Copper+ (PSC+)		Semi-Solid True-Concentric Perfect-Surface Silver (PSS) and Perfect-Surface Copper+ (PSC+)	
Gauge	3.31mm <sup>2</sup>					
Technology	ZERO-Tech (No Characteristic Impedance) for Uncompressed Current Transfer; RF/ND-Tech					
Jacket	Dark Blue/Black Braid		Silver/Black Braid		Black/Black Braid	
Terminations	Direct-Gold and Silver Plated; Cold-Welded Connectors					
Length	UK Retail	UK Retail	UK Retail	UK Retail	UK Retail	UK Retail
1m	389.00	689.00	649.00	949.00	1,819.00	2,119.00
2m	529.00	829.00	829.00	1,129.00	3,169.00	3,469.00
3m	669.00	969.00	1,009.00	1,309.00	4,519.00	4,819.00
Other prepared lengths use formula:	-	140.00/m + 549.00	-	180.00/m + 769.00	-	1,350.00/m + 769.00

### Mistral AC Power Bulk Cable

**Metal:** Semi-Solid True-Concentric Perfect-Surface Copper+ (PSC+) and Long-Grain Copper (LGC)

**Gauge:** 3.31mm<sup>2</sup>

**Technology:** RF/ND-Tech

**Jacket:** Dark Gray/Light Gray PVC

**Terminations:** Mistral AC Power Plugs

**50m Spool**

**Retail: 110.00/m**

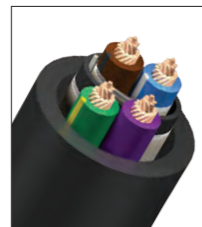

### Mistral AC Power Plugs

Sold separately.



Mistral Wall Plug  
Retail: 129.00



Mistral IEC C-13 Plug  
Retail: 129.00



Mistral IEC C-19 Plug  
Retail: 139.00

## AC Power Cables: Storm Series

Never assume which of these is required for a component or power conditioner. Some manufacturers prefer the performance of one IEC inlet type over another—even when their circuit's current draw is minimal.

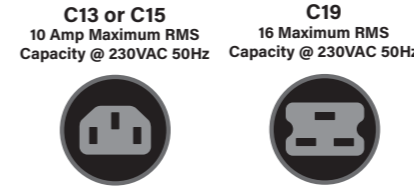

Plugs for Storm Series

**High (Variable) Current AC Power Cables** - Optimized for use with AC power conditioners/regenerators, power amplifiers, and any components that contain a built-in power amplifier, including AV receivers, powered speakers, and powered subwoofers.

Model	Thunder 72v DBS	Tornado 72v DBS	Hurricane 72v DBS	FireBird 72v DBS	Dragon 72v DBS
Conductor Metal	Solid Perfect-Surface Copper+ (PSC+) plus Long-Grain Copper (LGC)	Solid Perfect-Surface Copper+ (PSC+)		Solid Perfect-Surface Silver (PSS) plus Solid Perfect-Surface Copper+ (PSC+)	Solid Perfect-Surface Silver (PSS)
RF Drain Metal	Solid 6% Silver		Solid Perfect-Surface Silver (PSS)		
Technology	ZERO-Tech (No Characteristic Impedance) for Uncompressed Current Transfer; RF/ND-Tech				
Jacket	Brown/Black Braid	Silver/Black Braid	Dark Blue/Black Braid	Dark Red/Black Braid	Black/Black Braid
Termination and Gauge	Hanging-Silver over Red and Beryllium Copper - 4.17mm <sup>2</sup> Line and Neutral - 3.31mm <sup>2</sup> Ground				
Length	UK Retail	UK Retail	UK Retail	UK Retail	UK Retail
1m	949.00	1,339.00	1,609.00	3,199.00	5,099.00
2m	1,149.00	1,679.00	2,369.00	5,399.00	9,199.00
3m	1,349.00	2,019.00	3,129.00	7,599.00	13,299.00
Other prepared lengths use formula:	200.00/m + 749.00	340.00/m + 999.00	760.00/m + 849.00	2,200.00/m + 999.00	4,100.00/m + 999.00

**Constant-Current (Source) AC Power Cables** - Optimized for use with audio/video source components, which have a constant or "fixed" current draw.

Model	-	Tornado 72v DBS	Hurricane 72v DBS	FireBird 72v DBS	Dragon 72v DBS
Conductor Metal	-	Solid Perfect-Surface Copper+ (PSC+)		Solid Perfect-Surface Silver (PSS)	
RF Drain Metal	-	Solid 6% Silver	Solid Perfect-Surface Silver (PSS)		
Termination and Gauge	-	Hanging-Silver over Red and Beryllium Copper - 1.31mm <sup>2</sup> Line, Neutral and Ground			
Length	-	UK Retail	UK Retail	UK Retail	UK Retail
1m	-	1,069.00	1,359.00	2,699.00	3,999.00
2m	-	1,239.00	1,819.00	4,499.00	7,099.00
3m	-	1,409.00	2,279.00	6,299.00	10,199.00
Other prepared lengths use formula:	-	170.00/m + 899.00	460.00/m + 899.00	1,800.00/m + 899.00	3,100.00/m + 899.00

## AC Power Accessories



### Female to Male IEC C-13 Adaptors

Premium Single-Piece Metal Conductors from Input to All Outputs Preserve Advantages of Superior AudioQuest NRG Series AC Cables.

#### IEC90°/1

Adaptor Bends in Direction of 1 Center

UK Retail: 19.95

#### IEC90°/2

Adaptor Bends in Direction of 2 Outer Pins

UK Retail: 19.95



### C7 90° Adaptor Kit

- Provides 90° bends for C7 power connections
- Also connects for double bends
- Non-polarized for maximum flexibility

Package contains:

- 1 x "E" adaptor
- 1 x "U" adaptor

UK Retail: 39.90

C7 90° Adaptors also available in Installer 5-Packs, page 60.

### Fog Lifters

Reduce the RF noise that capacitively couples into cables through all solid materials (carpet, stone, wood, etc.)



Set of 8

UK Retail: 129.00

## Speaker Cables

### Meticulously Designed to Minimize Noise and Distortion

#### Do No Harm: The Four Elements Today

AudioQuest's Four Elements are always applied in the most thoughtful, effective ways to offer the best performance for the money—at all price points. While our implementation of these techniques has evolved over the years, our guiding principle remains the same: *Do No Harm*.

#### Solid Conductors

Strand interaction remains the biggest potential source of distortion in cables. Solid Conductors are the aspirational ideal and most complete solution to this problem. However, thoughtfully arranged multi-conductor geometries such as concentric windings are used to create our Semi-Solid Conductor technologies. These avoid many strand-distortion mechanisms and are in their own right ideal in a growing number of applications.

#### High-Purity Metal

Higher-purity conductor metals with smoother surfaces and internal crystal structures greatly reduce noise and distortion. Carefully finessed mixes of metals and conductor sizes can be effectively used to define a cable's *Sonic Signature*—a cost-effective technique for high-value, high-performance models.

#### Noise-Dissipation

Unwanted Radio-Frequency (RF) noise is and has always been picked up and induced into cable. This contamination ultimately masks and distorts critical portions of the audio/video signal. As this distortion-causing (parasitic) RF signal is more present today than at any previous time in history, we must depend on a wider arsenal of Noise-Dissipation technologies:

- Directionally Controlled conductors minimize high-frequency noise by "directing" or draining it away from the most vulnerable circuits.
- ZERO-Technology (No Characteristic Impedance) applies Ultra-Linear Noise-Dissipation across the widest range of frequencies possible. It also enables uncompressed transient current transfer for AC power and loudspeaker/power amplifier applications.
- RF/ND-Tech (Patented Radio-Frequency Ground-Noise Dissipation) minimizes circuit misbehavior by cancelling induced RF noise.
- Tried-and-true DBS has evolved to include RF-Noise Traps that further reduce dielectric distortion and induced noise.

#### Dielectric

Insulation is necessary between conductors to minimize signal interaction and electrical shorts. The ideal is virtually no dielectric interaction (such as is achieved with our ZERO-Technology). However, by optimizing the dielectric material between signal conductors, this distortion is greatly minimized.





## Speaker Cable Applications

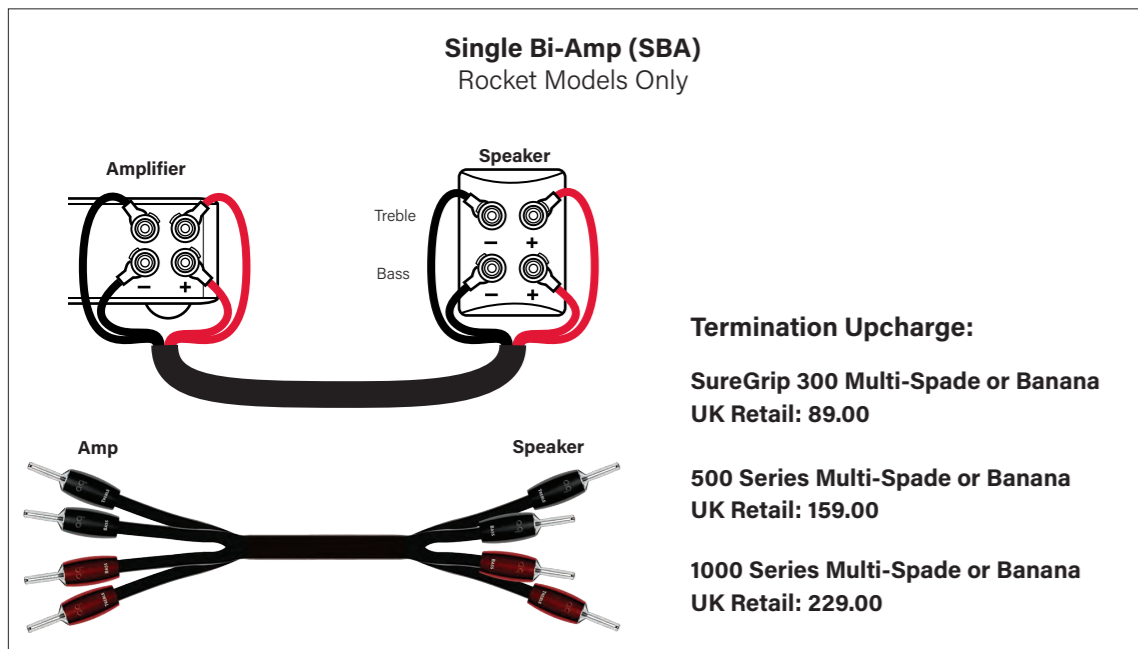
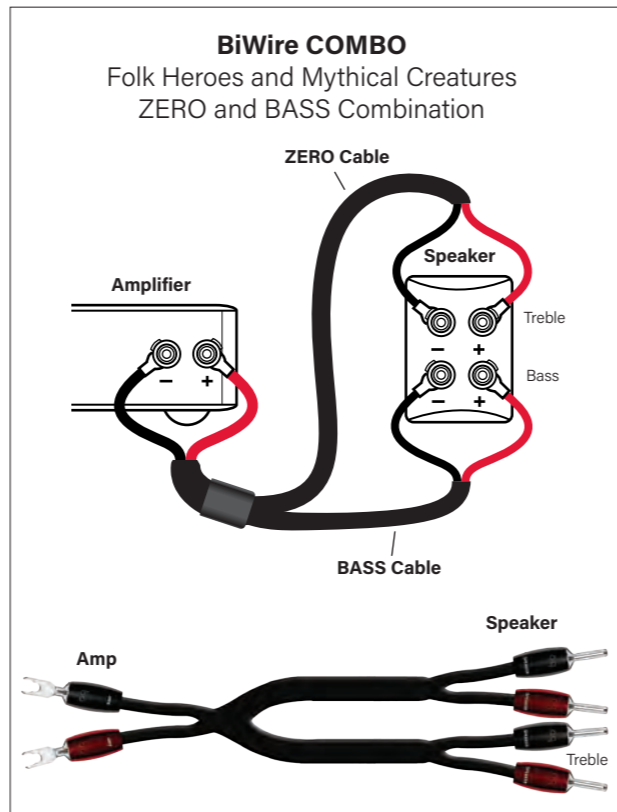
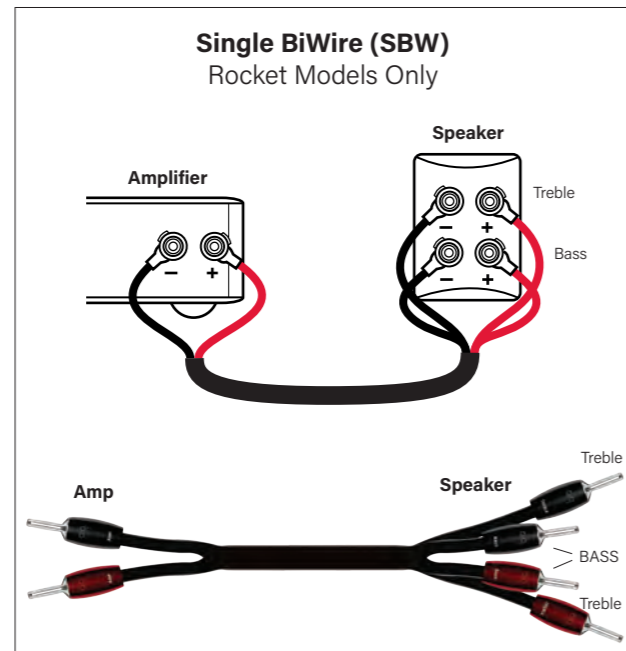
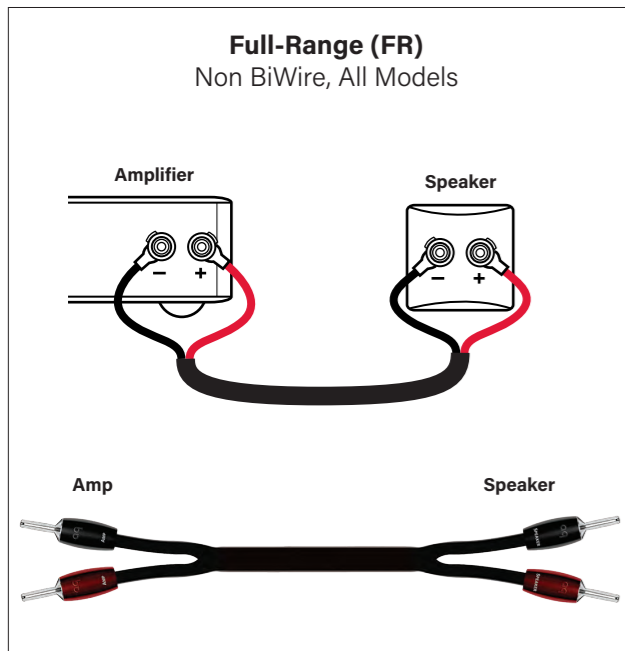

## Mythical Creature & Folk Hero Termination Options: Bananas or Spades?

**Amplifier-End Connector:**  
Choice of 1000 Series Multi-Spade, Banana, U-Spade, or V-Spade (Silver only)



Often, the choice between terminating speaker cables with spade lugs or banana plugs will come down to personal preference. However, today's EU-compliant isolated binding posts are being used on more power amplifiers than ever before. This sometimes makes it difficult, if not impossible, to use a banana connector. Further, given the girth and weight of our Mythical Creature Series speaker cables, a spade may be better capable of fully supporting the cable. This is particularly a concern with binding posts that do not allow a banana connector to fully seat into the post.

Further, the EU-compliant posts will neither accept our V-Spade nor allow our Multi-Spade to be fully seated. For these applications (or when you're not certain), **we highly recommend the U-Spade**, as it can accommodate any binding post. The V-Spade is a specialty spade connector that works well with large wingnut binding posts (such as the Mundorf), as it allows extra clearance.

Insulated (compliant) binding posts may not allow for 2 sets of connectors.

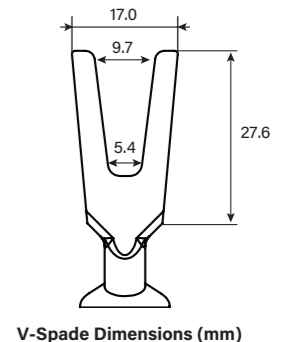
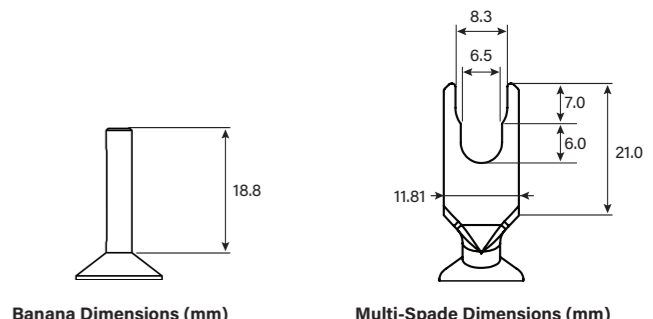

**Speaker-End Connector:**  
Choice of 1000-Series Spade or Banana (Silver only)

Here we typically recommend the **U-Spade** or banana connector. However, even though there is less weight and pressure on this side of the cable (particularly for BiWire sets), it is nevertheless important to note the binding post's design. If a banana connector cannot seat all the way into the binding post, we recommend one of our spade connectors.

## How to Order Prepared Speaker Cables

First please specify type of connector (banana or appropriate spade), then the finish of connector (silver\*). (\*or gold where applicable)

Pair prices shown. Also available in singles (i.e. for center channel, subwoofer, or mono) at half pair price.

When ordering any factory-terminated speaker cable, please include the required elements shown in the examples below:

Qty.	Pair or Single	Length	Model	FR/BWC/SBW	Amplifier Termination	Speaker Termination	Silver or Gold
1	Pair	3m	Rocket 88	FR	Spade	Banana	Silver
1	Single	2m	William Tell	COMBO	U-Spade	Banana	N/A
1	Single	3m	Rocket 44	SBW	Spade	Banana	Gold

## Speaker Cables: Q2 and Type Series (5, 9, Type 9+DBS)

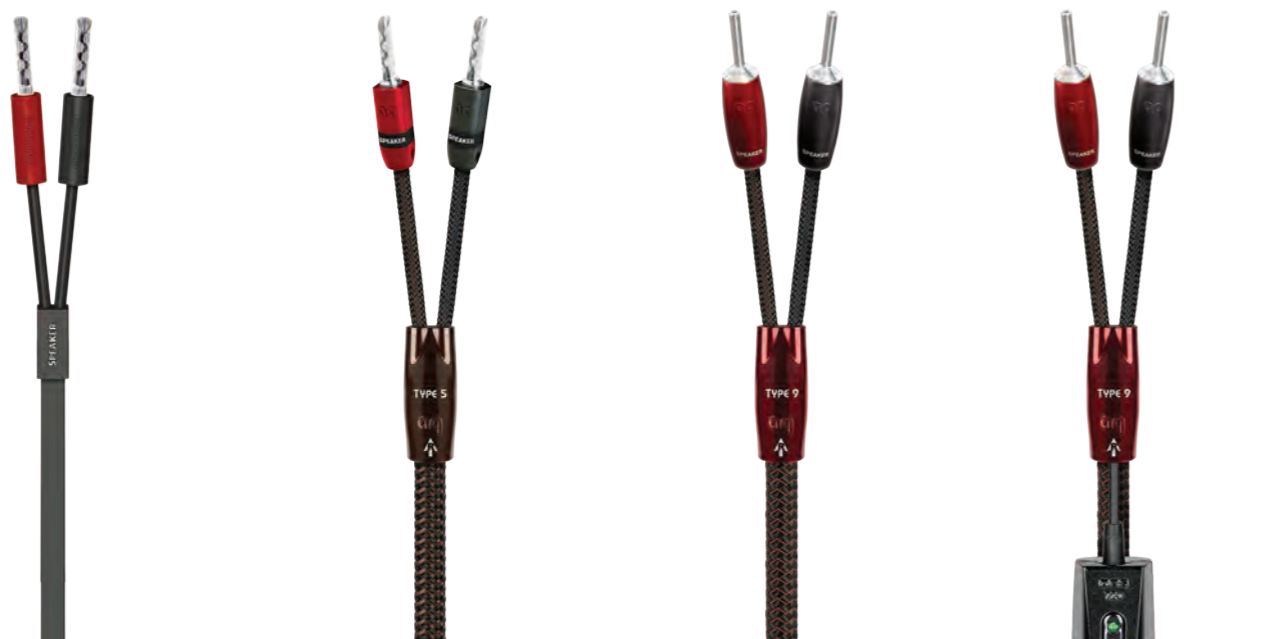
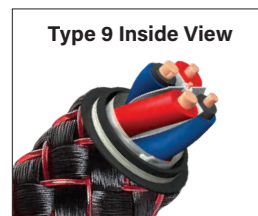
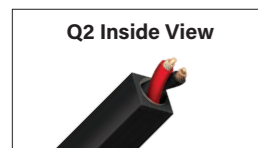

Model	Q2	Type 5	Type 9	Type 9+DBS 72v DBS
<b>Metal</b>	Concentric Long-Grain Copper (LGC)	Solid PSC+ Sonic-Signature Conductors and Long-Grain Copper (LGC)	Solid Perfect-Surface Copper+ (PSC+)	
<b>Gauge</b>	1.65mm <sup>2</sup>	1.65mm <sup>2</sup>	1.65mm <sup>2</sup>	1.65mm <sup>2</sup>
<b>Geometry</b>	Low-Inductance Twisted-Pair		Star-Quad	
<b>Noise-Dissipation</b>	No	Carbon-Based Noise-Dissipation	Multi-Layer Carbon-Based Noise-Dissipation	
<b>Jacket</b>	<b>Prepared:</b> Black PVC <b>Bulk:</b> White or Black PVC	<b>Prepared:</b> Brown/Black Braid <b>Bulk:</b> Red Striped PVC	Red/Black Braid	
<b>Plugs</b>	<b>Prepared:</b> SureGrip 100 (Silver) Banana <b>Bulk:</b> SureGrip 100 (Silver or Gold) Banana	SureGrip 300 (Silver or Gold) Choice of Multi-Spade or Banana	500 Series (Silver or Gold) Choice of Multi-Spade or Banana	1000 Series (Silver) Choice of Multi-Spade or Banana
<b>Prepared Lengths</b>	<b>UK Retail</b>	<b>UK Retail</b>	<b>UK Retail</b>	<b>UK Retail</b>
2m Pair	-	479.00	659.00	1,049.00
2.5m Pair	-	504.00	709.00	1,099.00
3m Pair	299.00	529.00	759.00	1,149.00
4m Pair	-	579.00	859.00	1,249.00
Other prepared lengths use formula (per pair)	-	50.00/m + 379.00	100.00/m + 459.00	100.00/m + 849.00
<b>Bulk Cables (on spools)</b>	<b>UK Retail</b>	<b>UK Retail</b>	<b>UK Retail</b>	<b>UK Retail</b>
50m	-	-	-	-
100m	14.00/m	25.00/m	-	-

## Speaker Cables: Rocket Series

\*Please Specify Termination

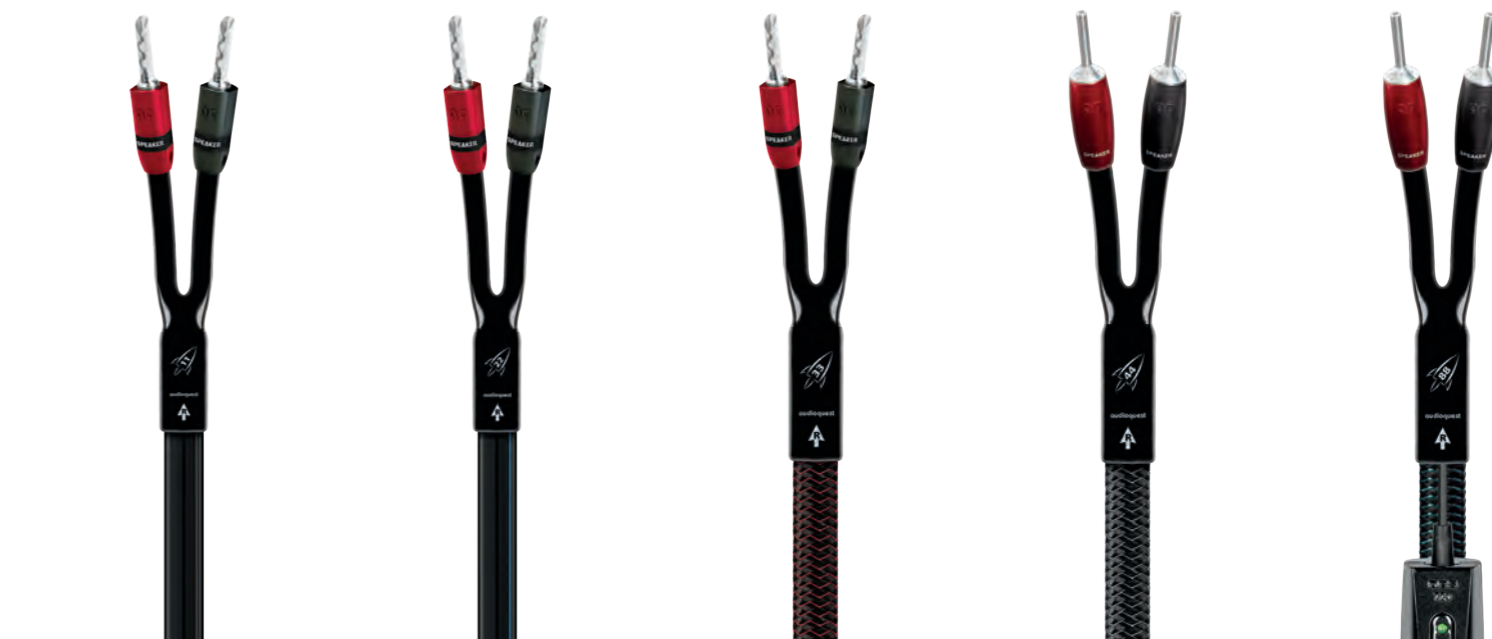

Model	Rocket 11	Rocket 22	Rocket 33	Rocket 44	Rocket 88 72v DBS
<b>*Application Options</b>	Full-Range and Single-BiWire		Full-Range, Single-BiWire, REL and Optimized for Naim		
<b>Metal</b>	Semi-Solid Concentric Long-Grain Copper (LGC)	Semi-Solid Concentric PSC and LGC	Solid PSC and LGC	Solid PSC+ and PSC	Solid PSC+
<b>Gauge</b>	2.08mm <sup>2</sup>	3.31mm <sup>2</sup>	2.08mm <sup>2</sup>	2.63mm <sup>2</sup>	
<b>Geometry</b>	Double Spiral-Pair		Double Star-Quad		
<b>Dielectric</b>	PVC		Foamed-Polyethylene (For All Positive Conductors)		
<b>Noise-Dissipation</b>	No	Carbon-Based Noise-Dissipation			
<b>Jacket</b>	Black or White PVC with Grey stripes	Black or White PVC with Blue stripes	Red/Black Braid or PVC	Silver/Black Braid or PVC	Green/Black Braid or PVC
<b>Plugs</b>	SureGrip 300 (Silver or Gold) Choice of Multi-Spade or Banana		SureGrip 300 (Silver or Gold) Choice of Multi-Spade or Banana	500 Series (Silver or Gold) Choice of Multi-Spade or Banana	
<b>Prepared Lengths</b>	<b>UK Retail</b>	<b>UK Retail</b>	<b>UK Retail</b>	<b>UK Retail</b>	<b>UK Retail</b>
2m Pair	329.00	409.00	539.00	669.00	1,039.00
2.5m Pair	349.00	449.00	599.00	749.00	1,149.00
3m Pair	369.00	489.00	659.00	829.00	1,259.00
4m Pair	409.00	569.00	779.00	989.00	1,479.00
Other prepared lengths use formula (per pair)	40.00/m + 249.00	80.00/m + 249.00	120.00/m + 299.00	160.00/m + 349.00	220.00/m + 599.00
<b>Bulk Cables (on spools)</b>	<b>UK Retail</b>	<b>UK Retail</b>	<b>UK Retail</b>	<b>UK Retail</b>	<b>UK Retail</b>
50m	20.00/m	40.00/m	60.00/m	80.00/m	110.00/m
100m	20.00/m	40.00/m	60.00/m	-	-

## Speaker Cables: Robin Hood (Folk Heroes)



Model	Robin Hood ZERO ● 72v DBS	Robin Hood BASS ● 72v DBS	Robin Hood ZERO BiWire COMBO (ZERO + BASS) ● 72v DBS	Robin Hood SILVER ● 72v DBS	Robin Hood SILVER BiWire COMBO (SILVER + BASS) ● 72v DBS
<b>Metal</b>	Solid Perfect-Surface Copper+ (PSC+)		Refer to Specs for ZERO and BASS	Solid PSS Sonic-Signature Conductors and PSC+	Refer to Specs for SILVER and BASS
<b>Gauge</b>	1.65mm <sup>2</sup>			1.65mm <sup>2</sup>	
<b>Geometry</b>	ZERO-Tech (No Characteristic Impedance)			ZERO-Tech (No Characteristic Impedance)	
<b>Noise-Dissipation</b>	Multi-Layer Carbon-Based Noise-Dissipation	RF/ND-Tech		Multi-Layer Carbon-Based Noise-Dissipation	
<b>Jacket</b>	Dark Green/Black Braid	Black Braid		Light Gray/Black Braid	
<b>Application Options</b>	Full-Range, or BiWire COMBO (when combined with BASS cable)	BiWire COMBO (when combined with ZERO cable)		Full-Range, or combined with BASS to form a BiWire COMBO	
<b>Plug Options</b> (1000 Series, Silver)	AMP-Side: Choice of U-Spade (recommended default), Banana, Multi-Spade, or V-Spade / SPEAKER-Side: Choice of U-Spade (recommended default), Banana, or Multi-Spade				
<b>Prepared Lengths</b>	<b>UK Retail</b>	<b>UK Retail</b>	<b>UK Retail</b>	<b>UK Retail</b>	<b>UK Retail</b>
2m Pair	1,609.00	1,609.00	3,219.00	5,399.00	7,009.00
2.5m Pair	1,779.00	1,779.00	3,559.00	6,499.00	8,279.00
3m Pair	1,949.00	1,949.00	3,899.00	7,599.00	9,549.00
4m Pair	2,289.00	2,289.00	4,579.00	9,799.00	12,089.00
<b>Other prepared lengths use formula (per pair)</b>	<b>340.00/m + 929.00</b>	<b>340.00/m + 929.00</b>	<b>680.00/m + 1,859.00</b>	<b>2,200.00/m + 999.00</b>	<b>2,540.00/m + 1,929.00</b>

## Speaker Cables: William Tell (Folk Heroes)



Model	William Tell ZERO ● 72v DBS	William Tell BASS ● 72v DBS	William Tell ZERO BiWire COMBO (ZERO + BASS) ● 72v DBS	William Tell SILVER ● 72v DBS	William Tell SILVER BiWire COMBO (SILVER + BASS) ● 72v DBS
<b>Metal</b>	Solid Perfect-Surface Copper+ (PSC+)	Solid PSC+ Sonic-Signature Conductors and LGC	Refer to Specs for ZERO and BASS	Solid PSS Sonic-Signature Conductors and PSC+	Refer to Specs for SILVER and BASS
<b>Gauge</b>	2.62mm <sup>2</sup>			2.62mm <sup>2</sup>	
<b>Geometry</b>	ZERO-Tech (No Characteristic Impedance)			ZERO-Tech (No Characteristic Impedance)	
<b>Noise-Dissipation</b>	Multi-Layer Carbon-Based Noise-Dissipation	RF/ND-Tech		Multi-Layer Carbon-Based Noise-Dissipation	
<b>Jacket</b>	Dark Red/Black Braid	Black Braid		Silver/Black Braid	
<b>Application Options</b>	Full-Range, or BiWire COMBO (when combined with BASS cable)	BiWire COMBO (when combined with ZERO cable)		Full-Range, or BiWire COMBO (when combined with BASS cable)	
<b>Plug Options</b> (1000 Series, Silver)	AMP-Side: Choice of U-Spade (recommended default), Banana, Multi-Spade, or V-Spade / SPEAKER-Side: Choice of U-Spade (recommended default), Banana, or Multi-Spade				
<b>Prepared Lengths</b>	<b>UK Retail</b>	<b>UK Retail</b>	<b>UK Retail</b>	<b>UK Retail</b>	<b>UK Retail</b>
2m Pair	2,699.00	2,299.00	4,999.00	6,949.00	9,249.00
2.5m Pair	3,049.00	2,549.00	5,599.00	8,349.00	10,899.00
3m Pair	3,399.00	2,799.00	6,199.00	9,749.00	12,549.00
4m Pair	4,099.00	3,299.00	7,399.00	12,549.00	15,849.00
<b>Other prepared lengths use formula (per pair)</b>	<b>700.00/m + 1,299.00</b>	<b>500.00/m + 1,299.00</b>	<b>1,200.00/m + 2,599.00</b>	<b>2,800.00/m + 1,349.00</b>	<b>3,300.00/m + 2,649.00</b>

## Speaker Cables: ThunderBird (Mythical Creatures)

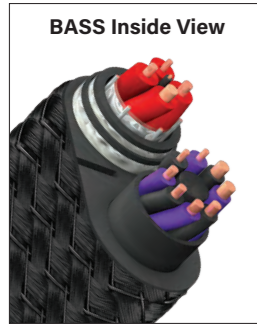

Model	ThunderBird ZERO ● 72v DBS	ThunderBird BASS ● 72v DBS	ThunderBird ZERO BiWire COMBO (ZERO + BASS) ● 72v DBS
Metal	Solid Perfect-Surface Copper+ (PSC+)	Solid PSC+ Sonic-Signature Conductors and LGC	Refer to Specs for ZERO and BASS
Gauge	5.26mm <sup>2</sup>		
Geometry	ZERO-Tech (No Characteristic Impedance)		
Noise-Dissipation	Multi-Layer Carbon-Based Noise-Dissipation	RF/ND-Tech	
Jacket	Blue/Black Braid		
Application Options	Full-Range, or BiWire COMBO (when combined with BASS cable)	BiWire COMBO (when combined with ZERO cable)	
Plug Options (1000 Series, Silver)	AMP-Side: Choice of U-Spade (recommended default), Banana, Multi-Spade, or V-Spade / SPEAKER-Side: Choice of U-Spade (recommended default), Banana, or Multi-Spade		
Prepared Lengths	UK Retail	UK Retail	UK Retail
2m Pair	4,500.00	3,700.00	8,200.00
2.5m Pair	5,150.00	4,150.00	9,300.00
3m Pair	5,800.00	4,600.00	10,400.00
4m Pair	7,100.00	5,500.00	12,600.00
Other prepared lengths use formula (per pair)	1,300.00/m + 1,900.00	900.00/m + 1,900.00	2,200.00/m + 3,800.00

## Speaker Cables: FireBird (Mythical Creatures)



Model	FireBird ZERO ● 72v DBS	FireBird BASS ● 72v DBS	FireBird BiWire COMBO (ZERO + BASS) ● 72v DBS
Metal	Solid Perfect-Surface Silver (PSS) Sonic-Signature Conductors and Perfect-Surface Copper+ (PSC+)		Refer to Specs for ZERO and BASS
Gauge	5.26mm <sup>2</sup>		
Geometry	ZERO-Tech (No Characteristic Impedance)		
Noise-Dissipation	Multi-Layer Carbon-Based Noise-Dissipation	RF/ND-Tech	
Jacket	Dark Red/Black Braid		
Application Options	Full-Range, or BiWire COMBO (when combined with BASS cable)	BiWire COMBO (when combined with ZERO cable)	
Plug Options (1000 Series, Silver)	AMP-Side: Choice of U-Spade (recommended default), Banana, Multi-Spade, or V-Spade / SPEAKER-Side: Choice of U-Spade (recommended default), Banana, or Multi-Spade		
Prepared Lengths	UK Retail	UK Retail	UK Retail
2m Pair	13,100.00	9,700.00	22,800.00
2.5m Pair	15,900.00	11,650.00	27,550.00
3m Pair	18,700.00	13,600.00	32,300.00
4m Pair	24,300.00	17,500.00	41,800.00
Other prepared lengths use formula (per pair)	5,600.00/m + 1,900.00	3,900.00/m + 1,900.00	9,500.00/m + 3,800.00

## Speaker Cables: Dragon (Mythical Creatures)



Model	Dragon ZERO ● 72v DBS	Dragon BASS ● 72v DBS	Dragon BiWire COMBO (ZERO + BASS) ● 72v DBS
<b>Metal</b>	Solid Perfect-Surface Silver (PSS) Sonic-Signature Conductors and Perfect-Surface Copper+ (PSC+)		Refer to Specs for ZERO and BASS
<b>Gauge</b>	5.26mm <sup>2</sup>		
<b>Geometry</b>	ZERO-Tech (No Characteristic Impedance)		
<b>Noise-Dissipation</b>	Multi-Layer Carbon-Based Noise-Dissipation	RF/ND-Tech	
<b>Jacket</b>	Black Braid		
<b>Application Options</b>	Full-Range, or BiWire COMBO (when combined with BASS cable)	BiWire COMBO (when combined with ZERO cable)	
<b>Plug Options (1000 Series, Silver)</b>	AMP-Side: Choice of U-Spade (recommended default), Banana, Multi-Spade, or V-Spade / SPEAKER-Side: Choice of U-Spade (recommended default), Banana, or Multi-Spade		
<b>Prepared Lengths</b>	<b>UK Retail</b>	<b>UK Retail</b>	<b>UK Retail</b>
2m Pair	24,300.00	18,700.00	43,000.00
2.5m Pair	29,900.00	22,900.00	52,800.00
3m Pair	35,500.00	27,100.00	62,600.00
4m Pair	46,700.00	35,500.00	82,200.00
<b>Other prepared lengths use formula (per pair)</b>	<b>11,200.00/m + 1,900.00</b>	<b>8,400.00/m + 1,900.00</b>	<b>19,600.00/m + 3,800.00</b>

## Speaker Cable Accessories

### Bare Naked BiWire Jumpers

Solid PSC+ conductors offer dramatically superior performance to stamped jumpers.



Set of 4 (8.9 cm each)  
UK Retail: 44.95

### Fog Lifters

Reduce the RF noise that capacitively couples into cables through all solid materials (carpet, stone, wood, etc.)



Set of 8  
UK Retail: 129.00

### Binding-Post Wrench

Real tool-quality double-ended nut driver with metal inserts.

Fits 11.11 mm and 12.7mm binding posts.



UK Retail: 17.95

### ThunderBird and Dragon BiWire Jumpers

Direction-Controlled Solid Perfect-Surface Copper+ (PSC+) Perfect-Surface Silver (PSS) and Carbon-Loaded Insulation. Available in Spade-Spade, Spade-Banana, Banana-Spade, and Banana-Banana.

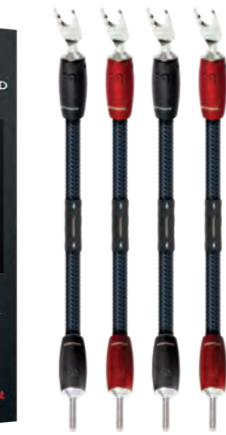

**ThunderBird (PSC+)** uses Hanging-Silver 500 Series Bananas or Spades.

Set of 4 (20 cm each)  
UK Retail: 299.00



**Dragon (PSS)** uses Hanging-Silver 1000 Series Bananas or Spades.

Set of 4 (20cm each)  
UK Retail: 649.00

### Using BiWire Jumpers with Full-Range Cables on BiWire Capable Speakers

#### 3-Way or Panel-Hybrid Speaker

Please connect amp. directly to the critical midrange and tweeter Treble input, and then jumper down to the Bass input.

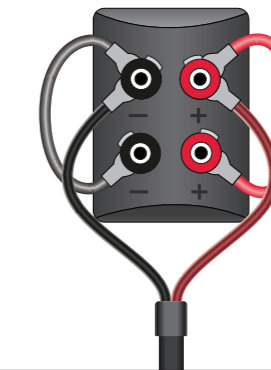

#### 2-Way Speaker

To maintain the speaker design's delicate midrange/tweeter relationship, please connect signal to Treble (+) and Bass (-).

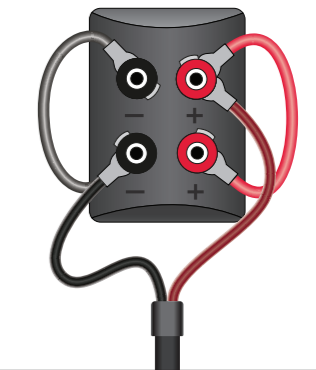

# Audio Interconnect Cables

*The Higher You Climb, The Less You Hear?*

The evolution of AudioQuest's audio cables is a steady climb up a mountain whose summit we'll never reach — there is always room for improvement and growth, as evidenced by our new Mythical Horses and Mythical Creatures interconnects. Perhaps less intuitive is the fact that climbing up our Analog Interconnect line means you hear less of the cable.

The reason is simple: As more of the delicate audio signal is protected from damage along the way, the listener experiences more of the truth and emotional impact of the music. Greater faithfulness to the audio signal is made possible by the use of superior materials and the careful implementation of increasingly sophisticated design and construction techniques.

Music is wonderfully complex, and our ears are very sensitive to its nuances. The remarkably affordable Bridges & Falls Series is an amazing place to start the journey. For those who want better performance and can sacrifice the physical flexibility and diverse connectivity options afforded by Bridges & Falls, the Rivers and Elements are excellent choices. Every step up the ladder to the state-of-the-art Mythical Creatures Series delivers even more clarity, smoother and more natural sound, greater dynamic slam, and more nuanced expression from the music.

As you climb with your customers, you'll hear progressions in metal, from Solid Long-Grain Copper to Perfect-Surface Copper+, and PSS Silver; in Geometry, from Double- to Triple-Balanced; in insulation, from Foamed-PE to FEP Air-Tubes; and in Noise-Dissipation techniques, from Metal-Layer to Carbon-Layer to Graphene/Carbon Mesh-Network and our patented Dielectric-Bias System. And finally, in our newest "Mythical" interconnects, ZERO-Tech, which eliminates the cable's characteristic impedance for an even more "invisible" sonic signature.

Throughout the line, the AQ performance-driven value system is always 100% evident. Climb until the incremental cost of the higher model is no longer the least expensive way to make the most improvement — but don't be surprised if your customers find themselves at the top of the line before reaching that point!



## Audio Interconnect Cables: Bridges & Falls

Tower and Golden Gate also available in Installer 5-Packs, page 60.



Model	Tower	Evergreen	Golden Gate	Big Sur	Sydney	Yosemite 72v DBS	Angel 72v DBS
<b>Metal</b>	Solid Long-Grain Copper (LGC)		Solid Perfect-Surface Copper (PSC)	Solid Perfect-Surface Copper+ (PSC+)			Solid Perfect-Surface Silver (PSS)
<b>Geometry</b>	Asymmetrical Double-Balanced (Lower Impedance on Ground, Same Quality + and - Conductors)						
<b>Dielectric</b>	Foamed-Polyethylene				Polyethylene Air-Tubes		FEP Air-Tubes
<b>Noise-Dissipation</b>	Metal-Layer Noise-Dissipation				Carbon-Based Noise-Dissipation		
<b>Jacket</b>	Black with White Stripes PVC	Green/Black Braid	Red/Black Braid	Brown/Black Braid	Dark Gray/Black Braid	Green/Black Braid	Silver/Black Braid
<b>Termination</b>	Cold-Welded, Gold-Plated			Cold-Welded, Gold-Plated Pure Purple Copper	Cold-Welded, Direct-Silver Plated Pure Purple Copper	Cold-Welded, Direct-Silver Plated Pure Red Copper	
<b>Application</b>							
<b>3.5mm Male Mini - 2-Male RCA</b>				Yes			
<b>2-Male RCA - 2-Male RCA</b>				Yes			
<b>3.5mm Male Mini - 3.5mm Male Mini</b>				Yes			
<b>3.5mm Male Mini - 3.5mm Female Mini</b>	3m and 5m Only	No	2m and 5m Only	No	No	Yes	
<b>3.5mm Male Mini - 5 Pin DIN</b>				Yes			
<b>5 Pin DIN - 5 Pin DIN</b>				Yes			
<b>5 Pin DIN - 2-Male RCA</b>				Yes			
<b>Length</b>	<b>UK Retail</b>	<b>UK Retail</b>	<b>UK Retail</b>	<b>UK Retail</b>	<b>UK Retail</b>	<b>UK Retail</b>	<b>UK Retail</b>
0.6m	38.95	75.00	99.00	135.00	209.00	399.00	859.00
1m	42.95	79.00	109.00	139.00	239.00	439.00	1,029.00
1.5m	46.95	85.00	119.00	155.00	275.00	489.00	1,244.00
2m	49.95	89.00	129.00	169.00	309.00	539.00	1,459.00
3m	59.95	99.00	139.00	195.00	379.00	639.00	1,889.00
5m	76.95	129.00	189.00	245.00	519.00	839.00	2,749.00
8m	99.95	179.00	239.00	319.00	729.00	1,139.00	4,039.00
12m	135.95	239.00	309.00	419.00	1,009.00	1,539.00	5,759.00
16m	169.95	299.00	389.00	519.00	1,289.00	1,939.00	7,479.00
20m	199.95	359.00	469.00	619.00	1,569.00	2,339.00	9,199.00
<b>Other prepared lengths use formula:</b>	-	-	-	-	-	100.00/m + 399.00	430.00/m + 599.00

## Audio Interconnect Cables: Rivers & Mythical Horses

In order to preserve ZERO-Tech's complete isolation between signal conductors, a Double-DBS pack is included for Pegasus XLR cables.



Model	Chicago	Red River		Mackenzie		Yukon		Black Beauty*		Pegasus*		
		RCA	XLR	RCA	XLR	RCA	XLR	RCA	XLR	RCA 72v DBS	XLR Double 72v DBS	
<b>Metal</b>	Solid Long-Grain Copper (LGC)	Solid Perfect-Surface Copper (PSC)		Solid Perfect-Surface Copper+ (PSC+)								
<b>Technology</b>	N/A				ZERO-Tech (No Characteristic Impedance)							
<b>Ground Reference</b>	All Cables Have Separate Ground-Reference Conductors Plus One Signal Conductor for RCA and Two for XLR											
<b>Dielectric</b>	Hard-Cell Foamed Polyethylene				Polyethylene Air-Tubes		Hard-Cell Foamed Polyethylene		Polypropylene Air-Tubes			
<b>Noise-Dissipation</b>	Metal-Layer			Carbon Mesh-Network				ZERO-Tech + Graphene/Carbon		72v DBS + ZERO-Tech Graphene/Carbon		
<b>Jacket</b>	Green/Black Braid	Red/Black Braid		Brown/Black Braid		Black/Dark Gray Braid		Black/Black Braid		Brown/Black Braid		
<b>Plug Barrels</b>	N/A											
<b>Cold-Welded Plugs</b>	Gold-Plated			Hanging-Silver over Purple Copper				Hanging-Silver over Red Copper				
<b>Length (Pair)</b>	<b>UK Retail</b>	<b>UK Retail</b>	<b>UK Retail</b>	<b>UK Retail</b>	<b>UK Retail</b>	<b>UK Retail</b>	<b>UK Retail</b>	<b>UK Retail</b>	<b>UK Retail</b>	<b>UK Retail</b>	<b>UK Retail</b>	
0.5m	109.00	189.00	239.00	274.00	344.00	399.00	469.00	-	-	-	-	
0.6m	-	-	-	-	-	-	-	659.00	819.00	1,299.00	1,579.00	
0.75m	114.00	199.00	249.00	286.50	356.50	429.00	509.00	-	-	-	-	
1m	119.00	209.00	259.00	299.00	369.00	459.00	549.00	729.00	939.00	1,439.00	1,779.00	
1.5m	129.00	229.00	279.00	324.00	394.00	519.00	629.00	819.00	1,089.00	1,609.00	2,029.00	
2m	139.00	249.00	299.00	349.00	419.00	579.00	709.00	909.00	1,239.00	1,779.00	2,279.00	
3m	159.00	289.00	339.00	399.00	469.00	699.00	869.00	1,089.00	1,539.00	2,119.00	2,779.00	
4m	179.00	329.00	379.00	449.00	519.00	819.00	1,029.00	1,269.00	1,839.00	2,459.00	3,279.00	
5m	199.00	369.00	419.00	499.00	569.00	939.00	1,189.00	1,449.00	2,139.00	2,799.00	3,779.00	
6m	219.00	409.00	459.00	549.00	619.00	1,059.00	1,349.00	1,629.00	2,439.00	3,139.00	4,279.00	
<b>For longer lengths, please use formula:</b>	20.00/pair m + 99.00/pair	40.00/pair m + 169.00/pair	40.00/pair m + 219.00/pair	50.00/pair m + 249.00/pair	50.00/pair m + 319.00/pair	120.00/pair m + 339.00/pair	160.00/pair m + 389.00/pair	180.00/pair m + 549.00/pair	300.00/pair m + 639.00/pair	340.00/pair m + 1,099.00/pair	500.00/pair m + 1,279.00/pair	

Bulk Cables	Chicago	Red River	Mackenzie
UK Retail per metre	10.00 (100m spool)	20.00 (100m spool)	25.00m (50m Spool)

28 Bulk Chicago, Red River, and Mackenzie cables available braided or CL3/FT4 PVC. See page 58.

\*ZERO-Tech Cables do not work as turntable cables with moving coil cartridges.

## Audio Interconnect Cables: Mythical Creatures

In order to preserve ZERO-Tech's complete isolation between signal conductors, a Double-DBS pack is included for XLR cables.

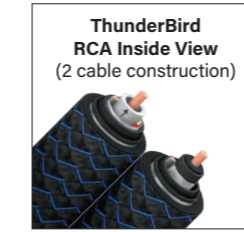

Model	ThunderBird*		FireBird*		Dragon*	
	RCA 72v DBS	XLR Double 72v DBS	RCA 72v DBS	XLR Double 72v DBS	RCA 72v DBS	XLR Double 72v DBS
<b>Metal</b>	Solid Perfect-Surface Copper+ (PSC+)			Solid Perfect-Surface Silver (PSS)		
<b>Technology</b>	ZERO-Tech (No Characteristic Impedance), ZERO-Tech Cables do not work as turntable cables with moving coil cartridges					
<b>Dielectric</b>	FEP Air-Tubes					
<b>Noise-Dissipation</b>	ZERO-Tech + 72v DBS + Graphene/Carbon Mesh-Network				PSS Drains + ZERO-Tech + 72v DBS + Graphene/Carbon	
<b>Jacket</b>	Blue/Black Braid		Red/Black Braid		Black/Black Braid	
<b>Plug Barrels</b>	Copper-Plated RF-Draining			Silver-Plated RF-Draining		
<b>Plug Contacts</b>	Hanging-Silver over Red-Copper					
<b>Length (Pair)</b>	<b>UK Retail</b>	<b>UK Retail</b>	<b>UK Retail</b>	<b>UK Retail</b>	<b>UK Retail</b>	<b>UK Retail</b>
0.5m	2,149.00	2,849.00	4,099.00	5,099.00	6,799.00	8,249.00
0.75m	2,424.00	3,224.00	4,799.00	6,049.00	7,849.00	9,624.00
1m	2,699.00	3,599.00	5,499.00	6,999.00	8,899.00	10,999.00
1.5m	3,249.00	4,349.00	6,899.00	8,899.00	10,999.00	13,749.00
2m	3,799.00	5,099.00	8,299.00	10,799.00	13,099.00	16,499.00
2.5m	4,349.00	5,849.00	9,699.00	12,699.00	15,199.00	19,249.00
3m	4,899.00	6,599.00	11,099.00	14,599.00	17,299.00	21,999.00
4m	5,999.00	8,099.00	13,899.00	18,399.00	21,499.00	27,499.00
5m	7,099.00	9,599.00	16,699.00	22,199.00	25,699.00	32,999.00
6m	8,199.00	11,099.00	19,499.00	25,999.00	29,899.00	38,499.00
<b>Other prepared lengths, use formula:</b>	1,100.00/pair m + 1,599.00/pair	1,500.00/pair m + 2,099.00/pair	2,800.00/pair m + 2,699.00/pair	3,800.00/pair m + 3,199.00/pair	4,200.00/pair m + 4,699.00/pair	5,500.00/pair m + 5,499.00/pair

\*ZERO-Tech Cables do not work as turntable cables with moving coil cartridges.

29

## Audio Interconnect Accessories



**FLX-Mini Splitter**  
3.5mm Mini Male Stereo >  
(2) 3.5mm Female Stereo  
**Metal:** Solid Perfect-Surface  
Copper+ (PSC+)  
**Length:** 15cm

**UK Retail: 24.95**



**FLX-Mini/RCA Adaptor**  
3.5mm Mini Male Stereo <>  
2 Female RCA (L & R)  
**Metal:** Solid Perfect-Surface  
Copper+ (PSC+)  
**Length:** 15cm

**UK Retail: 24.95**



**Hard Mini/RCA Adaptor**  
Hard Mini 3.5mm Male <>  
2 Female RCA (L & R)

**UK Retail: 17.95**



**FLX-X RCA Splitter**  
RCA Male >  
2 Female RCA (L & R)  
**Metal:** Solid Long-Grain  
Copper (LGC)  
**Length:** 15cm

**UK Retail: 22.95**



**FLX-X RCA Splitter**  
RCA Female >  
2 Male (L & R)  
**Metal:** Solid Long-Grain  
Copper (LGC)  
**Length:** 15cm

**UK Retail: 22.95**



**M21F-90 Adaptor**  
Female RCA to Right Angle  
Male RCA

**UK Retail: 11.95**



**Hard RCA Splitter**  
Male RCA > 2 Female RCA

**UK Retail: 19.95**



**RCA - RCA Coupler**  
Female RCA <> Female RCA

**UK Retail: 9.95**



**PreAmp Jumpers**  
Solid Perfect-Surface Copper+ (PSC+) conductors in Polyethylene Air-Tubes. Replaces factory fitted "U" jumpers on integrated amps and receivers.

**UK Retail: 46.95**

## Subwoofer Cables



Model	Black Lab	Greyhound	Irish Red	Boxer	Husky	
					RCA 72v DBS	XLR 72v DBS
<b>Metal</b>	Solid Long-Grain Copper (LGC)	0.5% Silver	Solid 0.5% Silver	Solid 1.25% Silver	Solid 5% Silver	
<b>Geometry</b>	Symmetrical Coax	HyperLitz Coax	Symmetrical Coax	Double-Balanced	Triple-Balanced	
<b>Dielectric</b>	Foamed-Polyethylene			Polyethylene Air-Tubes		
<b>Noise-Dissipation</b>	Metal-Layer Noise-Dissipation			Carbon-Based Noise-Dissipation	Carbon-Based Multi-Layer Noise-Dissipation	
<b>Jacket</b>	Black with White Stripes CL3/FT4 Rated PVC	Light Gray-Striped White CL3/FT4 Rated PVC	Up to 5m: Red/Black Braid 8m and Longer CL3/FT4 Rated: Black PVC with Red Stripes	Up to 5m: Brown/Black Braid 8m and Longer CL3/FT4 Rated: Black PVC with Brown Stripes	Blue/Black Braid or CL3/FT4 Rated Black PVC with Blue Stripes (Any Length)	
<b>Termination</b>	Cold-Welded, Gold-Plated			Cold-Welded, Hanging-Silver directly over pure Red Copper		
<b>Application - Attached Chassis-Ground Connector</b>						
<b>RCA - RCA</b>	Yes					
<b>RCA/XLR Mixed</b>	No			Yes		
<b>Meters</b>	<b>UK Retail</b>	<b>UK Retail</b>	<b>UK Retail</b>	<b>UK Retail</b>	<b>UK Retail</b>	<b>UK Retail</b>
2m	48.95	64.95	89.00	179.00	389.00	429.00
3m	56.95	74.95	99.00	204.00	459.00	499.00
5m	72.95	94.95	119.00	254.00	599.00	639.00
8m	96.95	124.95	149.00	329.00	809.00	849.00
12m	128.95	164.95	189.00	429.00	1,089.00	1,129.00
16m	160.95	204.95	229.00	529.00	1,369.00	1,409.00
20m	192.95	244.95	269.00	629.00	1,649.00	1,689.00
<b>Other prepared lengths use formula:</b>	-	-	-	-	70.00/m + 249.00	70.00/m + 289.00

Note: Greyhound is optimized for custom-installation projects that require its thin, discreet design. It does not include a chassis-ground connector.





## Tonearm Cables



Model	Golden Gate	Yosemite 72v DBS	Angel 72v DBS	WEL Signature Limited Edition 72v DBS
<b>Metal</b>	Solid Perfect-Surface Copper (PSC)	Solid Perfect-Surface Copper+ (PSC+)	Solid Perfect-Surface Silver (PSS)	
<b>Dielectric</b>	Foamed-Polyethylene	FEP Air-Tubes		
<b>Noise-Dissipation</b>	N/A	Carbon-Based Noise-Dissipation		Carbon-Based Multi-Layer Noise-Dissipation
<b>Capacitance</b>	Less than 90pF/1.5M			
<b>Jacket</b>	Red/Black Braid	Green/Black Braid	Silver/Black Braid	Gray/Black Braid
<b>Length</b>	<b>UK Retail</b>	<b>UK Retail</b>	<b>UK Retail</b>	<b>UK Retail</b>
1.2m	-	469.00	1,099.00	2,149.00
1.5m	139.00	-	-	-
<b>Other prepared lengths use formula:</b>	-	100.00/m + 349.00	430.00/m + 583.00	600.00/m + 1,369.00

## Turntable Cables



Model	Golden Gate	Yosemite 72v DBS	Angel 72v DBS	WEL Signature Limited Edition 72v DBS
<b>Metal</b>	Solid Perfect-Surface Copper (PSC)	Solid Perfect-Surface Copper+ (PSC+)	Solid Perfect-Surface Silver (PSS)	
<b>Dielectric</b>	Foamed-Polyethylene	FEP Air-Tubes		
<b>Noise-Dissipation</b>	N/A	Carbon-Based Noise-Dissipation		Carbon-Based Multi-Layer Noise-Dissipation
<b>Capacitance</b>	Less than 90pF/1.5M			
<b>Jacket</b>	Red/Black Braid	Green/Black Braid	Silver/Black Braid	Gray/Black Braid
<b>Length</b>	<b>UK Retail</b>	<b>UK Retail</b>	<b>UK Retail</b>	<b>UK Retail</b>
1.2m	-	469.00	1,099.00	2,149.00
1.5m	139.00	-	-	-



## Vinyl and Headphone Accessories

### GroundGoody Tonearm & Ground Wires

Unlike other ground wires that act as radio-frequency antennas, Black Hole, ThunderBird and Dragon GroundGoodys prevent hum while efficiently dissipating radio-frequency noise. GroundGoodys use premium conductor materials that are controlled for direction and cold-welded to Direct-Silver Plated #10 size spade lugs. Further, AudioQuest's RF/ND-Tech dissipates and cancels most induced radio-frequency noise.



#### Black Hole GroundGoody

Solid 6% Silver + Carbon RF Trap

Meters	UK Retail
0.75m	49.00
1.5m	59.00
2.25m	69.00
3m	79.00
5m	99.00



#### ThunderBird GroundGoody

Solid 6% Silver + RF/ND-Tech

Meters	UK Retail
0.6m	99.00
1m	119.00
1.5m	139.00
2m	159.00
3m	199.00



#### Dragon GroundGoody

Solid Perfect-Surface Silver + RF/ND-Tech

Meters	UK Retail
0.6m	379.00
1m	509.00
1.5m	679.00
2m	849.00
3m	1,189.00



#### Silver Anti-Static Record Brush

1,086,000 Highly Conductive Carbon Fibers with No-Resistance Path to Finger-Grip

**UK Retail: 16.95**



#### Gold Anti-Static Record Brush

1,248,000 Highly Conductive Carbon Fibers with No-Resistance Path to Finger-Grip

**UK Retail: 24.95**



#### HL-5 Headshell Leads

Silk-wrapped Linear-Crystal Copper Litz Conductors

Set of 4

**UK Retail: 59.95**



#### NightBird Headphone Cable

- Fits NightHawk and NightOwl Headphones
- Perfect-Surface Copper+ (PSC+)
- Noise-Dissipation
- Robust: Tested to 28,000 bends

Meters	UK Retail
2m	99.00
3m	119.00
4m	139.00



#### Perch Headphone Stand

- Easily and safely accommodates all headphones
- High-quality materials
- Heavy base provides stability

**UK Retail: 89.00**

# HDMI Cables

## Does AudioQuest offer the right HDMI cables for 4K TVs, 8K TVs, and beyond?

**Yes!** All of AudioQuest's new 48Gbps HDMI cables can transfer up to professional 10K Ultra-HD video. The impressive 48Gbps data rate is made possible by four balanced audio/video pairs capable of 12Gbps each. And, of course, the latest technology is backwards compatible with 4K displays.

### Video Up to 10K

AudioQuest 48Gbps HDMI cables are completely backwards compatible with existing devices and have the bandwidth required for video with resolutions up to 10K and resolutions/refresh rates up to 8K/60 and 4K/120.

### HDR (High Dynamic Range)

All AudioQuest HDMI cables support HDR (High Dynamic Range) and Dynamic HDR. HDR content expands the contrast of the image for blacker blacks and brighter whites/highlights as well as greater color saturation and brightness. In addition, 4K Ultra-HD content allows for a wider color range.

This combination of technologies results in more realistic HDR images with greater perceived depth. Dynamic HDR (HDR10+ and Dolby Vision, for example) enables frame-by-frame HDR optimization rather than HDR settings that are fixed for the entire program. The most prominent current HDR formats are HDR10, HDR10+, and Dolby Vision.

AudioQuest 18Gbps and 48Gbps HDMI cables are compatible with all varieties of HDR, which can be found on Ultra-HD Blu-ray, and all major streaming services, including Netflix, Amazon Prime, Disney+, Apple TV+, and others.

### ARC (Audio Return Channel) and eARC (enhanced Audio Return Channel)

HDMI's Audio Return Channel (ARC) sends audio from a TV to a soundbar or AV receiver for greater simplicity and flexibility in system setup. Hardware's previous ARC capabilities max out at lossy (compressed) 5.1-channel surround sound.

Today's HDMI 2.1 hardware supports enhanced Audio Return Channel (eARC), which increases the digital bandwidth dramatically to support uncompressed and lossless high-resolution multichannel audio, including Dolby TrueHD and Atmos, and DTS-HD Master Audio and DTS: X.

**8K-10K**



**eARC**

**48G<sub>bps</sub>**

Not only do all current generations of AudioQuest HDMI cables have the conductors and bandwidth required for eARC's enhanced sonic capabilities, but, in order to ensure superior audio performance, the ARC-channel conductor-pair is internally controlled for direction, running in the opposite direction from the 4 pairs that carry information to the TV.

Finally, AudioQuest's eARC-Priority models include 4 Silver-Plated Forest 48-level audio/video data pairs—but with a far superior single data pair for the TV's audio output. By upgrading the ARC data path only, audiophile quality is made possible at a fraction of the cost of upgrading all 5 data pairs.



### New Packaging

AudioQuest has turbo-charged all of its HDMI packaging with easy-to-read icons and explanations of the design and material elements that define each cable and its place in the line. Comparing, contrasting and selecting the right cable is easier than ever before.



<p><b>1.25% SILVER</b></p> <p><b>Solid Conductors</b></p>	<p><b>LEVEL 3</b> Carbon Mesh-Network</p> <p><b>Noise Dissipation</b></p>	<p><b>eARC</b></p> <p><b>1.25% Silver Level-3 ND</b></p>	<p><b>Limited</b></p> <p><b>Lifetime Warranty</b></p>	<p><b>48G<sub>bps</sub></b></p> <p><b>4 x 12 = 48</b></p>
<p>Solid Long-Grain Copper, Silver-Plated Copper, or Perfect-Surface Silver maximize Noise-Dissipation and overall performance.</p>	<p>Six Levels of Noise-Dissipation (ND) combat distortion caused by RF Noise contaminating digital and analog circuitry.</p>	<p>Because sound is where all the emotion and drama comes from, AQ's eARC channel gets 100% the same love as the four AV channels.</p>	<p>We've got your back. Performance backed by reliability.</p>	<p>The 48Gbps necessary for all of HDMI's new and future features is made possible by upgrading the 4 AV channels from 6 to 12Gbps.</p>

## HDMI: 0.75m–5m Cables

### 18Gbps 4K and 48Gbps 8K-10K

- All models use Solid Signal and Ground-Reference Conductors.
- All 19 conductors (A/V, eARC, Ground-Reference Drains, Control, Power) are Direction-Controlled.
- AudioQuest "48" HDMI cables have the bandwidth required for video with resolutions up to 10K, resolutions/refresh rates up to 8K/60 and 4K/120.
- For long-length models (Pearl 18, Forest 18, Root Beer 18, Cherry Cola 18, and Cherry Cola 48), see page 39.

**BlueBerry 18, Pearl 48, Forest 48, and Cinnamon 48 available in Installer 5-Packs, page 61.**



Model	BlueBerry 18	Pearl 48	Forest 48	Cinnamon 48	Carbon 48	Vodka 48	ThunderBird 48	FireBird 48 ● 72v DBS	Dragon 48 ● 72v DBS
<b>A/V Conductor</b>	Solid Long-Grain Copper (LGC)		0.5% Silver	1.25% Silver	5% Silver	10% Silver	10% Silver	100% PSS Silver	100% PSS Silver
<b>eARC Conductor</b>	Solid Long-Grain Copper (LGC)		0.5% Silver	1.25% Silver	5% Silver	10% Silver	10% Silver	100% PSS Silver	100% PSS Silver
<b>Ground Reference</b>	Tinned Copper			0.5% Silver	1.25% Silver	5% Silver	10% Silver	10% Silver	100% PSS Silver
<b>Noise-Dissipation</b>	All 19 Conductors Direction-Controlled			Carbon + Metal + Direction	Carbon + Metal + Direction	Carbon + Metal + Direction	Graphene + Global Carbon + Direction	72v DBS, Graphene + Global Carbon + Direction	
<b>Jacket 0.6-2m</b>	CMG (CL3/FT4) PVC			Red Braid	Carbon Braid	Blue Braid	Blue Braid	Red Braid	Black Braid
<b>Jacket 3m</b>	CMG (CL3/FT4) PVC			Red Braid or PVC	Carbon Braid	Blue Braid	Blue Braid	Red Braid	Black Braid
<b>Jacket 5m</b>	CMG (CL3/FT4) PVC			-	-	-	-	-	-
<b>Length</b>	<b>UK Retail</b>	<b>UK Retail</b>	<b>UK Retail</b>	<b>UK Retail</b>	<b>UK Retail</b>	<b>UK Retail</b>	<b>UK Retail</b>	<b>UK Retail</b>	<b>UK Retail</b>
0.6m	25.95	34.95	59.00	119.00	149.00	379.00	649.00	1,359.00	1,949.00
1m	29.95	39.95	69.00	135.00	179.00	439.00	759.00	1,499.00	2,289.00
1.5m	33.95	44.95	79.00	149.00	229.00	499.00	889.00	1,749.00	2,699.00
2m	39.95	49.95	99.00	169.00	269.00	579.00	999.00	1,999.00	3,109.00
3m	49.95	69.95	139.00	229.00	359.00	709.00	1,269.00	2,699.00	3,989.00
5m	89.95	169.95	249.00	379.00	-	-	-	-	-

## HDMI: Long-Length Cables

### 18Gbps 4K and 48Gbps 8K-10K

- Pearl 18 and Forest 18 employ active frequency equalization to enable 18Gbps performance for lengths up to 15m.
- Root Beer 18 active optical cable provides 18Gbps performance for lengths up to 30m.
- Certified Ultra High Speed by HDMI Licensing, Cherry Cola 48 active optical cables provide 48Gbps performance for lengths up to 50ft.



Model	Pearl 18 Long Distance	Forest 18 Long Distance	Root Beer 18 Optical	Cherry Cola 48 Optical
<b>A/V Conductor</b>	LGC	0.5% Silver	Quartz-Glass	Quartz-Glass
<b>eARC Conductor</b>	LGC	0.5% Silver	LGC	0.5% Silver
<b>Ground Reference</b>	Tinned Copper			0.5% Silver
<b>Noise-Dissipation</b>	All 19 Conductors Direction-Controlled		Galvanic Isolation + Direction	Carbon + Galvanic Isolation
<b>Jacket</b>	CMG (CL3/FT4) PVC			
<b>Length</b>	<b>UK Retail</b>	<b>UK Retail</b>	<b>UK Retail</b>	<b>UK Retail</b>
5m	-	-	439.00	849.00
7.5m	199.00	319.00	-	-
10m	249.00	389.00	469.00	939.00
12.5m	299.00	459.00	-	-
15m	399.00	-	519.00	1,029.00
20m	-	-	579.00	-
25m	-	-	639.00	-
30m	-	-	689.00	-

## HDMI: eARC-Priority Cables

### 48Gbps 8K-10K

- When using a TV's eARC/ARC output as the audio source to a soundbar or an A/V receiver or an amplifier's ARC input, eARC-Priority models offer their namesake models ARC performance for less than half the price of the namesake model. This is possible because the cables' unused A/V data pairs "only" offer better-than-Cinnamon 48 performance.



Model	Vodka eARC Priority 48	ThunderBird eARC Priority 48	Dragon eARC Priority 48 ● 72v DBS
<b>A/V Conductor</b>	0.5% Silver	0.5% Silver	0.5% Silver
<b>eARC Conductor</b>	10% Silver	10% Silver	100% PSS Silver
<b>Ground Reference</b>	5% Silver eARC	10% Silver eARC	100% PSS Silver eARC
<b>Noise-Dissipation</b>	Carbon + Metal + Direction	Graphene + Global Carbon + Direction	72v DBS, Graphene + Global Carbon + Direction
<b>Jacket 0.75-2m</b>	Blue Braid	Blue Braid	Black Braid
<b>Jacket 3m</b>	CMG (CL3/FT4) PVC		
<b>Length</b>	<b>UK Retail</b>	<b>UK Retail</b>	<b>UK Retail</b>
0.6m	189.00	389.00	939.00
1m	199.00	419.00	999.00
1.5m	229.00	469.00	1,119.00
2m	249.00	499.00	1,379.00
3m	309.00	599.00	1,699.00

## HDMI Accessories

Certain HDMI Adaptors available in Installer 5-Packs, page 59.



**HDMI 90°/W Adaptor**  
Wide Side [W]  
Right Angle Bend

UK Retail: 17.95



**HDMI 90°/N Adaptor**  
Narrow Side [N]  
Right Angle Bend

UK Retail: 17.95



**HDMI 90° NU/R Flat Adaptor**  
Narrow Up [NU]  
Bends Right

UK Retail: 17.95



**HDMI 90° NU/L Flat Adaptor**  
Narrow Up [NU]  
Bends Left

UK Retail: 17.95



**HDMI A ↔ A Coupler**  
Female HDMI to Female  
HDMI

UK Retail: 17.95



**Mini Display Port to  
HDMI 4K Adaptor**

UK Retail: 34.95



**DVI-IN > HDMI-OUT  
Adaptor**  
F-DVI to M-HDMI

UK Retail: 34.95

## Digital-Audio Interconnect Cables

*Perfect Sound Forever?*

That bold statement introduced CD players to the world back in 1983. Those claiming perfection believed ones and zeros to be so beyond reproach that traditional concerns about the integrity of the playback system had become irrelevant overnight. But the CD wasn't close to perfect. Those who listened quickly figured out that the equipment and cables in the audio system mattered every bit as much as they had in the analog era.

However, to this day, stating the truth in public that digital-audio cables can make minor to even staggering differences in an audio system's performance is like yelling, "food fight" in a crowded cafeteria—you'd better get ready to duck because there will be incoming.

Yet, the same kind of music lovers and listeners who heard the CD for what it is also know that soul-satisfying digital-audio playback requires the best digital-audio cables. And the best cables reduce the most noise and distortion.

Today, there are more ways to consume digital audio than ever. Many gave up silver discs for the convenience of inferior-sounding compressed downloads, and now we've seemingly got the best of both convenience and performance: We are able to stream high-res files to our phones and mobile devices and into our homes.

AudioQuest's digital-audio cables employ all of our proven techniques for minimizing noise and distortion: better metals, better geometry, better dielectric, Dielectric-Bias System (DBS), Noise-Dissipation, Direction-Controlled Conductors, and other ingredients needed for optimizing each specific application.

The digital future is brighter and more beautiful sounding than ever...*if* your digital-audio cables are capable of treating fragile audio data as it deserves to be treated—that is, with the love and respect reserved for music.



## USB Cables

All USB A - C, USB C - B, USB C - C, Micro B, and Lightning cables are available in 0.75m and 1.5m lengths only.  
For optimal sonic performance, all AudioQuest USB cables are Hi-Speed with a maximum signaling rate of 480Mbps.

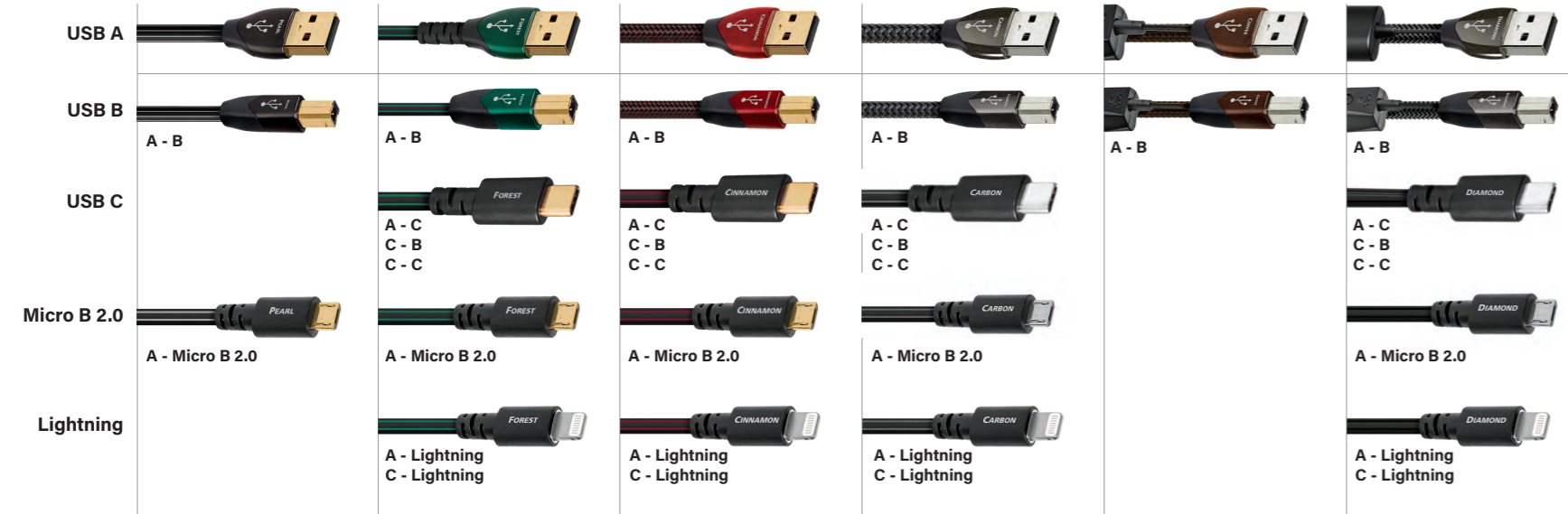

Model	Pearl	Forest	Cinnamon	Carbon	Coffee 72v DBS	Diamond 72v DBS
<b>Metal (USB A-B)</b>	Solid Long-Grain Copper (LGC)	Solid 0.5% Silver	Solid 1.25% Silver	Solid 5% Silver	Solid 10% Silver	Solid 100% Perfect-Surface Silver (PSS)
<b>Metal (All Other Versions)</b>	Long-Grain Copper (LGC) Semi-Solid Concentric	0.5% Silver Semi-Solid Concentric	1.25% Silver Semi-Solid Concentric	5% Silver Semi-Solid Concentric	N/A	Solid 100% Perfect-Surface Silver (PSS)
<b>Dielectric</b>	Hard-Cell Foam					
<b>Noise-Dissipation</b>	Metal-Layer Noise-Dissipation			Carbon-Based Noise-Dissipation for USB A - B and USB 3.0 A - 3.0 Micro		
<b>Jacket</b>	Black PVC with White Stripes	Black PVC with Green Stripes	USB A-B: Red/Black Braid All others: Black PVC with Red Stripes	Gray/Black Braid	Brown/Black Braid	USB A-B: Silver/Black Braid All others: Black PVC with Silver Stripes
<b>Available Configurations</b>	USB A - B USB A - Micro B	USB A - B USB A - C USB A - Micro B 2.0 USB A - Lightning USB C - B USB C - C USB C - Lightning	USB A - B USB A - C USB A - Micro B 2.0 USB A - Lightning USB C - B USB C - C USB C - Lightning	USB A - B USB A - C USB A - Micro B 2.0 USB A - Lightning USB C - B USB C - C USB C - Lightning	USB A - B	USB A - B USB A - C USB A - Micro B 2.0 USB A - Lightning USB C - B USB C - C USB C - Lightning
<b>Length</b>	<b>UK Retail</b>	<b>UK Retail</b>	<b>UK Retail</b>	<b>UK Retail</b>	<b>UK Retail</b>	<b>UK Retail</b>
0.75m	34.95	69.00	89.00	169.00	369.00	649.00
1.5m	44.95	85.00	119.00	209.00	449.00	789.00
3m	59.95 (A-B Only)	99.00 (A-B Only)	149.00 (A-B Only)	299.00 (A-B Only)	649.00	1,069.00 (A-B Only)
5m	84.95 (A-B Only)	135.00 (A-B Only)	199.00 (A-B Only)	429.00 (A-B Only)	829.00	1,449.00 (A-B Only)

## USB Connector Applications

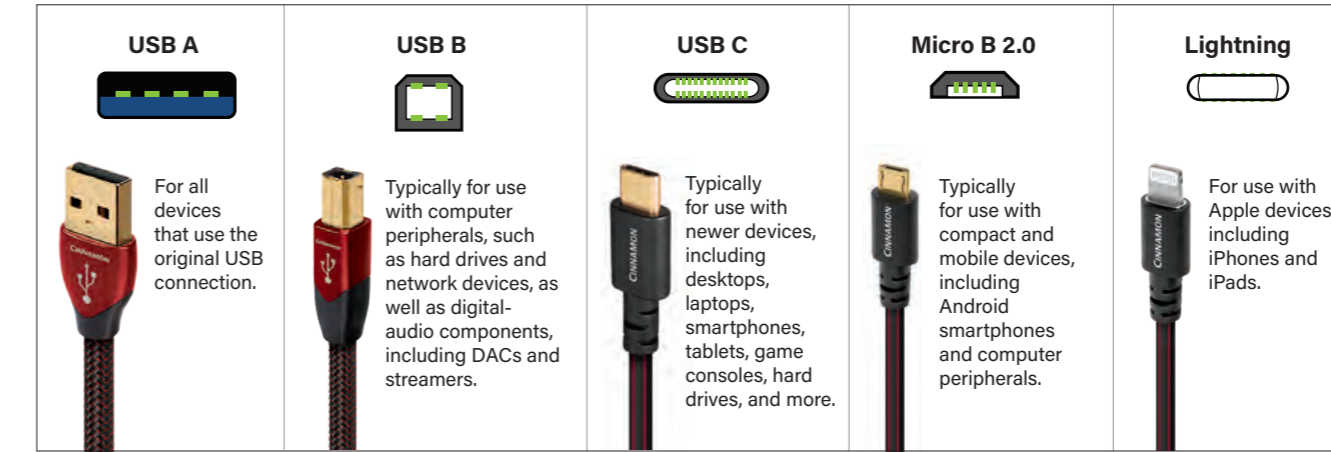

## USB Accessories



USB 3.1 Gen 2 C → A Adaptor

UK Retail: 21.95



USB B ↔ Micro B 2.0 Adaptor

UK Retail: 16.95



USB Mini B ↔ Micro B 2.0 Adaptor

UK Retail: 15.95



JitterBug FMJ  
USB 2.0 Noise Filter (Data & Power)

UK Retail: 59.00

## Optical Cables

Pearl, Forest, and Cinnamon available in Installer 5-Packs, page 60.



Model	Pearl	Forest	Cinnamon	Carbon	Vodka
<b>Conductors</b>	Low-Dispersion Fiber	Low-Dispersion High-Purity Fiber	Lower-Dispersion Highest-Purity Fiber	19 Narrow-Aperture Highest-Purity Synthetic Fibers	217 Narrowest-Aperture Highest-Purity Synthetic Fibers
<b>Jacket</b>	Black with Gray Stripes In-Wall Rated PVC	0.75m and 1.5m: Green/Black Braid 3m and Longer: In-Wall Rated PVC	0.75m and 1.5m: Red/Black Braid 3m and Longer: In-Wall Rated PVC	0.75m to 5m: Gray/Black Braid 8m and Longer: In-Wall Rated PVC	0.75m to 5m: Blue/Black Braid 8m and Longer: In-Wall Rated PVC
<b>Length</b>	<b>UK Retail</b>	<b>UK Retail</b>	<b>UK Retail</b>	<b>UK Retail</b>	<b>UK Retail</b>
0.75m	29.95	46.95	69.00	119.00	229.00
1.5m	34.95	54.95	85.00	159.00	299.00
3m	49.95	84.95	129.00	229.00	469.00
5m	69.95	119.95	169.00	319.00	649.00
8m	94.95	169.95	249.00	469.00	939.00
12m	129.95	239.95	369.00	639.00	1,279.00
16m	159.95	299.95	469.00	799.00	1,529.00

Pearl available in both 3.5mm Mini to Full-Size, and Full-Size to Full-Size.  
Forest, Cinnamon, Carbon, and Vodka come in Full-Size to Full-Size with 3.5mm Mini Adaptor included.

### Optical Accessory



**Optical Mini Adaptor**

**UK Retail: 15.95**

## Digital Coax Cables

Forest available in Installer 5-Packs, page 61.



### RCA > BNC

Recommended for Forest through Diamond.

Fully acceptable for Wild and WEL when BNC needed only on one end, or to keep an RCA/RCA cable universally useful.

**UK Retail: 16.95**



Model	Forest	Cinnamon	Carbon	Coffee 72v DBS	Diamond 72v DBS	Wild	WEL Signature	
<b>Metal</b>	Solid 0.5% Silver	Solid 1.25% Silver	Solid 5% Silver	Solid 10% Silver	Solid 100% Perfect-Surface Silver (PSS)			
<b>Gauge</b>	0.2mm <sup>2</sup>			0.41mm <sup>2</sup>				
<b>Dielectric</b>	Hard-Cell Foam							
<b>Noise-Dissipation</b>	Metal-Layer Noise-Dissipation			Carbon-Based Multi-Layer Noise-Dissipation			Carbon-Based Multi-Layer Noise-Dissipation, 2 x EMI Absorption	Carbon-Based Multi-Layer Noise-Dissipation, 3 x EMI Absorption
<b>Jacket</b>	Black PVC with Green Stripes	Red/Black Braid	Black/Dark Gray Braid	Brown/Black Braid	Silver/Black Braid	Navy Blue Braid	Black Braid	
<b>Terminations</b>	Cold-Welded, Gold-Plated		Cold-Welded, Hanging-Silver Directly Over Pure Purple Copper	Cold-Welded, Hanging-Silver Directly Over Pure Red Copper		Cold-Welded, Hanging-Silver Directly Over Machined Pure Red Copper		
<b>Shield</b>	Foil + Tinned Braid	Foil + Silver-Plated Braid		Silver-Plated Braid		Copper Foil + 100% PSS-Silver Spiral		
<b>Application</b>								
<b>RCA</b>	Yes							
<b>BNC</b>	No (Requires Female RCA to Male BNC adaptor)					Yes		
<b>Length</b>	<b>UK Retail</b>	<b>UK Retail</b>	<b>UK Retail</b>	<b>UK Retail</b>	<b>UK Retail</b>	<b>UK Retail</b>	<b>UK Retail</b>	
0.75m	39.95	79.00	209.00	569.00	1,049.00	1,965.00	3,350.00	
1m	-	-	229.00	609.00	1,199.00	2,155.00	3,700.00	
1.5m	46.95	89.00	269.00	699.00	1,499.00	2,535.00	4,400.00	
2m	-	-	299.00	789.00	1,799.00	2,915.00	5,100.00	
3m	64.95	129.00	369.00	969.00	2,399.00	3,675.00	6,500.00	
5m	84.95	169.00	509.00	1,329.00	3,599.00	5,195.00	9,300.00	
<b>Other prepared lengths use formula:</b>	-	-	70.00/m + 159.00	180.00/m + 429.00	600.00/m + 599.00	760.00/m + 1,395.00	1,400.00/m + 2,300.00	

## AES/EBU (Balanced) Cables



Model	Carbon	Wild ● 72v DBS	WEL Signature ● 72v DBS
<b>Metal</b>	Solid 5% Silver	Solid 100% Perfect-Surface Silver (PSS)	
<b>Gauge</b>	0,2mm <sup>2</sup>	0,41mm <sup>2</sup>	
<b>Dielectric</b>	Hard-Cell Foam		
<b>Noise-Dissipation</b>	Carbon-Based Multi-Layer Noise-Dissipation	Carbon-Based Multi-Layer Noise-Dissipation, 2 x EMI Absorption	Carbon-Based Multi-Layer Noise-Dissipation, 3 x EMI Absorption
<b>Jacket</b>	Dark Gray/Black Braid	Navy Blue Braid	Black Braid
<b>Termination</b>	Cold-Welded, Hanging-Silver Directly Over Pure Purple Copper	Cold-Welded, Hanging-Silver Directly Over Machined Pure Red Copper	
<b>Shield</b>	Foil + Tinned Braid	Foil + Silver-Plated Spiral	
<b>Length</b>	<b>UK Retail</b>	<b>UK Retail</b>	<b>UK Retail</b>
0,75m	244.00	2,449.00	4,175.00
1m	269.00	2,699.00	4,600.00
1,5m	319.00	3,199.00	5,450.00
2m	369.00	3,699.00	6,300.00
3m	469.00	4,699.00	8,000.00
5m	669.00	6,699.00	11,400.00
<b>Other prepared lengths use formula:</b>	<b>100.00/m + 169.00</b>	<b>1,000.00/m + 1,699.00</b>	<b>1,700.00/m + 2,900.00</b>

## Ethernet Cables (RJ/E)

Pearl, Forest and Cinnamon available in Installer 5-Packs, page 61.



Model	Pearl	Forest	Cinnamon	Vodka	Diamond ● 72v DBS
<b>Metal</b>	Solid Long-Grain Copper (LGC)	Solid 0.5% Silver	Solid 1.25% Silver	Solid 10% Silver	Solid 100% Perfect-Surface Silver (PSS)
<b>Dielectric</b>	Geometry Stabilizing Solid High-Density Polyethylene				
<b>Noise-Dissipation</b>	Direction-Controlled Conductors			Carbon-Based Noise-Dissipation	
<b>Jacket</b>	CMG (CL3 & FT4) Rated Black PVC with Gray Stripes	CMG (CL3 & FT4) Rated Black PVC with Green Stripes	Up to 3.0m: Red/Black Braid 5.0m and Longer: CMG (CL3 & FT4) Rated Black PVC with Red Stripes	Up to 3.0m: Blue/Black Braid 5.0m and Longer: CMG (CL3 & FT4) Rated Black PVC with Blue Stripes	Silver/Black Braid
<b>Termination</b>	Gold-Plated Nickel Connectors with 100% Shield Coverage			Precision-Made Low-Loss Ultra-Wide Bandwidth Telegärtner Connectors with 100% Shield Coverage and Strain Relief	
<b>Length</b>	<b>UK Retail</b>	<b>UK Retail</b>	<b>UK Retail</b>	<b>UK Retail</b>	<b>UK Retail</b>
0.75m	34.95	65.00	99.00	469.00	1,199.00
1.5m	49.95	79.00	119.00	599.00	1,849.00
3m	69.95	109.00	149.00	799.00	3,099.00
5m	99.95	139.00	199.00	1,149.00	4,599.00
8m	144.95	199.00	279.00	1,699.00	7,349.00
12m	199.95	279.00	379.00	2,349.00	10,999.00



## Accessories



### Level-X DBS Pack 72v + Noise-Dissipation

- Niagara Custom-Built Noise-Trap Dissipates RF Noise
- 72v Dielectric-Bias System Reduces Dielectric-Noise

UK Retail Each: 119.00



### SorboGel Q-Feet System

Set of 4 energy-absorbing feet each with a "tray" which improves performance and protects furniture. Each foot supports up to 4 kg.

UK Retail: 129.00



### Fog Lifters

For use with audio and AC power cables, Fog Lifters reduce the RF noise that capacitively couples into cables through all solid materials (carpet, stone, wood, etc.)

Set of 8 UK Retail: 129.00



### Cable Clips

Fast and easy way to hold AudioQuest's largest cables in place.

#### AC Power Cables:

- Thunder, Tornado, Hurricane, FireBird, Dragon

#### Speaker Cables:

- Robin Hood, William Tell
- ThunderBird, FireBird, Dragon

#### Interconnect Cables (RCA and XLR):

- ThunderBird, FireBird, Dragon

Set of 6 UK Retail: 10.00



### CleanScreen Kit

150 ml. Bottle + 10 ml. Spray + Retractable Brush

UK Retail: 24.95



### Sorbothane Self-Stick Sheet

15.24cm x 15.24cm x 0.25cm sheet can be cut to size to damp anything, especially effective on top surface of speaker stands.

UK Retail: 46.95



### Binding-Post Wrench

Real tool-quality double-ended nut driver with metal inserts. Fits 11.11 mm and 12.7mm binding posts.

UK Retail: 17.95

## Accessories



### RCA <math>\leftrightarrow</math> BNC Adaptor

Female RCA to/from Male BNC

UK Retail: 16.95



### F > RCA Male Adaptor

Female RCA to Male RCA

UK Retail: 11.95



### F > BNC Male Adaptor

75Ω

UK Retail: 16.95



### F > 2F Splitter

3GHz 75Ω

UK Retail: 16.95



### F > 4F Splitter

3GHz 75Ω

UK Retail: 21.95



### F <math>\leftrightarrow</math> F

75Ω Coupler

UK Retail: 8.95



### F-90°

Male <math>\leftrightarrow</math> Female Adaptor

UK Retail: 11.95



### Antenna 90°

Male <math>\leftrightarrow</math> Female Adaptor

UK Retail: 8.95

### Antenna Cable



Model	Antenna HD6 Forest
Conductor	Solid 0.5% Silver
Shield	3-Layer Shield: Foil + 90% Braid + Foil
Jacket	Dark Gray with Green Stripes
Application	
Male Coax - Male Coax	Yes
Male Coax - Female Coax	Yes
Female Coax - Female Coax	Yes
F - F	Yes
Length	UK Retail
1.5m	42.75
3m	55.50
4.5m	68.25

## Accessories

### RCA-300

Fits cables up to 7.0mm O.D.  
Gold-Plated. Requires soldering.



**#300 Male**  
Set of 4  
UK Retail: 50.00

**#300 Female**  
Set of 4  
UK Retail: 50.00

### RCA-800

Fits cables up to 9.0mm O.D.  
Direct-Silver Plated. Requires soldering.



**#800 Male**  
Set of 4  
UK Retail: 69.00

### XLR Connectors

Fits cables up to 9.0mm O.D.  
Direct-Silver Plated. Requires soldering.



**#81 Male**  
Pair  
UK Retail: 99.00

**#80 Female**  
Pair  
UK Retail: 99.00

### Right-Angle F and RCA Plugs

Fits cables up to 7.5mm O.D.  
Gold-Plated. Requires soldering.



**F-90°**  
Pair  
UK Retail: 42.50

**RCA-90°**  
Pair  
UK Retail: 42.50

## Accessories



### RJ45 Noise-Stopper Caps

AQ Noise-Stopper Caps fit over unused RJ45 inputs or outputs, preventing RFI and EMI noise from entering the active circuit. Noise-Stopper Caps also protect against dust and corrosion.

**Set of 4**  
UK Retail: 29.95



### USB-A Noise-Stopper Caps

AQ Noise-Stopper Caps fit over unused USB inputs or outputs, preventing RFI and EMI noise from entering the active circuit. Noise-Stopper Caps also protect against dust and corrosion.

**Set of 4**  
UK Retail: 29.95



### HDMI Noise-Stopper Caps

AQ Noise-Stopper Caps fit over unused HDMI inputs or outputs, preventing RFI and EMI noise from entering the active circuit. Noise-Stopper Caps also protect against dust and corrosion.

**Set of 4**  
UK Retail: 29.95



### XLR Input (Female) Noise-Stopper Caps

Blocks a significant path for incoming high-frequency energy to interfere with circuit performance.

**UK Retail**  
per Pair: 39.95

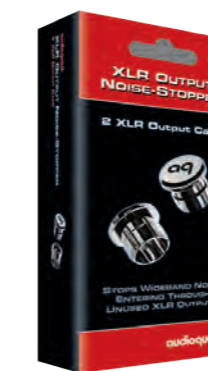

### XLR Output (Male) Noise-Stopper Caps

Blocks a significant path for incoming high-frequency energy to interfere with circuit performance.

**UK Retail**  
per Pair: 39.95

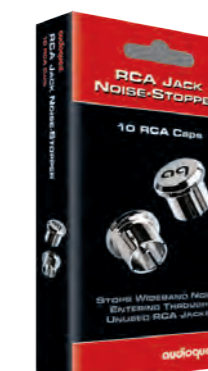

### RCA Noise-Stopper Caps

Blocks a significant path for incoming high-frequency energy to interfere with circuit performance.

**Set of 10**  
UK Retail: 46.95

## Tools

All the Tools necessary to Cut, Strip, Prepare, and Terminate any AudioQuest Cable



**Cat6/6a/7 Crimper Tool and Die**  
Includes Cat6 and Cat 7 Die



**Cat6 Die**  
Also sold separately



**AQ Ratchet Crimper Tool**  
For up to 8 AWG Conductors



**Rivers Interconnect Crimper Tool**  
Use with either AudioQuest Chicago RCA, Red River and Mackenzie RCA or XLR plugs.



**Klein Crimper Tool**  
For connectors up to 10 AWG



**Klein Cable Cutter**



**Ideal Articulated Stripper**  
For 8–22 AWG Conductors



**Wire Stripper/Cutter/Plier Combo Tool**



**Paladin Jacket Stripper**  
Cleanly and easily removes the jacket on all AudioQuest Interconnect and Speaker Cables



**AQ Silver Solder**  
Easy to use. Clearly sounds better.

**454g Solder**  
UK Retail: 295.00

**113.5g Solder**  
UK Retail: 85.00

## Instant Tool-less Connectors (ITC) for Analog-Audio, Mini-Coax, and RG6 Cables on Spools

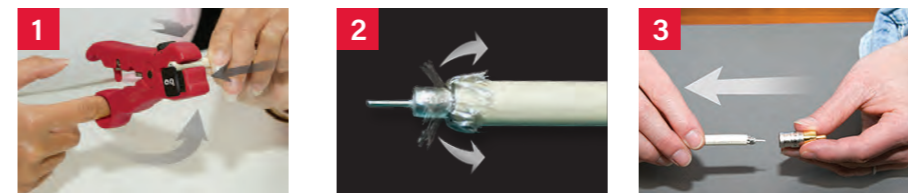

**ITC One-Step Stripper for 18 and 24 AWG**  
For HD6, ITA, and ITV Cables  
UK Retail: 10.00

### 18 AWG Connectors and Cables for Video, RF, Digital, Subwoofer



**ITC-18G RCA**  
UK Retail per piece: 3.25

Supplied in bags of 50



**ITC-18G F**  
UK Retail per piece: 2.50

Supplied in bags of 50



**ITC-18G BNC**  
UK Retail per piece: 4.75

Supplied in bags of 50



**ITC-18G EU Coax M**  
UK Retail per piece: 3.00

Supplied in bags of 50



**ITC-18G EU Coax F**  
UK Retail per piece: 3.00

Supplied in bags of 50

	HD6 Pearl	HD6 Forest	HD6 Carbon
<b>Metal</b>	Solid Conductive-Coated Copper	Solid 0.5% Silver	Solid 5% Silver
<b>Shield</b>	3-Layer Shield: Foil + 90% Braid + Foil		4-Layer Shield: Carbon-Loaded PE + Foil + 90% Braid + Foil
<b>CL3 Jacket Color Choices</b>	Dark Gray or White Stripes	Gray, Green or White Stripes	Black, Gray, or White Stripes
<b>Length</b>	<b>UK Retail</b>	<b>UK Retail</b>	<b>UK Retail</b>
<b>76m Spool</b>	-	-	17.00/m
<b>152m Spool</b>	5.50/m	8.50/m	-

### 24 AWG Connectors and Cables for Analog-Audio and Video



**ITC-24G RCA**  
UK Retail per piece: 3.25

Supplied in bags of 50



**ITC-24G F**  
UK Retail per piece: 3.25

Supplied in bags of 50



**ITC-24G BNC**  
UK Retail per piece: 4.75

Supplied in bags of 50

Audio	ITA-1/1	ITA-3/3	ITA-5/5
<b>Center Conductor Metal</b>	Solid Long-Grain Copper (LGC)	Solid Perfect-Surface Copper (PSC)	Solid Perfect-Surface Copper+ (PSC+)
<b>Neg. Conductor/Shield</b>	LGC HyperLitz	PSC HyperLitz	PSC+ HyperLitz
<b>CL3 Jacket</b>	Blue (Pair)	Green (Pair)	Dark Gray (Pair)
<b>Length</b>	<b>UK Retail</b>	<b>UK Retail</b>	<b>UK Retail</b>
<b>15m Spool</b>	10.50/m	-	-
<b>76m Spool</b>	10.50/m	17.00/m	25.00/m
<b>152m Spool</b>	10.50/m	-	-

**Color Bands for 18 and 24 AWG ITC Connectors**  
Silicon rubber bands fit all ITC connectors—even after they're attached to the cable—for easy cable identification. Available in bags of 20. One color per bag – no mixed colors. Available in 10 colors.

**Bag of 20**  
UK Retail: 15.00

  
Red

  
Blue

  
Yellow

  
Purple

  
Green

  
Black

## CL3/FT4 In-Wall Rated Bulk Speaker Cables

16/2 + 14/2

16/4 + 14/4



Model	SLiP-DB 16/2	SLiP-DB 16/4	SLiP-DB 14/2	SLiP-DB 14/4	SLiP XTRM 14/2	SLiP XTRM 14/4	SLiP-LSZH 16/2	SLiP-LSZH 14/2
<b>Metal</b>	Semi-Solid Concentric LGC				Semi-Solid True Concentric PSC and LGC		Semi-Solid Concentric LGC	
<b>Gauge</b>	2 x 1,31mm <sup>2</sup>	4 x 1,31mm <sup>2</sup>	2 x 2,08mm <sup>2</sup>	4 x 2,08mm <sup>2</sup>	2 x 2,08mm <sup>2</sup>	4 x 2,08mm <sup>2</sup>	2 x 1,31mm <sup>2</sup>	2 x 2,08mm <sup>2</sup>
<b>Jacket</b>	White PVC with Silver Stripes or Gray PVC with Red Stripes				Dark Gray PVC with Blue Stripes		LSZH (Low Smoke Zero Halogen) White PVC with Silver Stripes	
<b>Length</b>	<b>UK Retail</b>	<b>UK Retail</b>	<b>UK Retail</b>	<b>UK Retail</b>	<b>UK Retail</b>	<b>UK Retail</b>	<b>UK Retail</b>	<b>UK Retail</b>
50m Spool	-	-	-	-	25.00/m	-	-	-
100m Spool	-	-	-	-	25.00/m	45.00/m	-	-
152m Spool	5.50/m	8.50/m	7.50/m	12.00/m	-	-	8.25/m	10.50/m

## Bulk Speaker Cables – Not In-Wall Rated

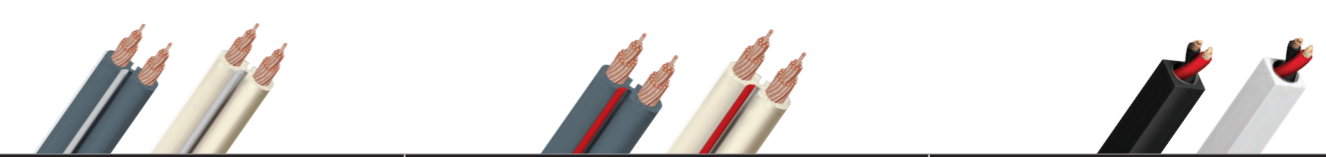

Model	G2	X2	Q2
<b>Metal</b>	Semi-Solid Concentric Long-Grain Copper (LGC)		
<b>Gauge</b>	1.31mm <sup>2</sup>	2.08mm <sup>2</sup>	1.65mm <sup>2</sup>
<b>Jacket</b>	Dark Gray PVC or Off-White PVC	Dark Gray PVC or Off-White PVC	Black PVC or White PVC
<b>Length</b>	<b>UK Retail</b>	<b>UK Retail</b>	<b>UK Retail</b>
10m - <i>White Only</i>	60.00	-	-
30m Pack - <i>White Only</i>	150.00	210.00	-
100m spool	6.00/m	8.50/m	14.00/m

Note: For 100m spools, retail price per meter is listed. Other packaged lengths are shown with retail price per pack.



Model	Type 5	Rocket 11	Rocket 22	Rocket 33	Rocket 44	Rocket 88
<b>Metal</b>	Solid PSC+ Sonic-Signature Conductors and LGC	Semi-Solid Concentric LGC	Semi-Solid Concentric PSC and LGC	Solid PSC and LGC	Solid PSC+ and PSC	Solid PSC+
<b>Gauge</b>	1.65mm <sup>2</sup>	2.08mm <sup>2</sup>	3.31mm <sup>2</sup>	2.08mm <sup>2</sup>	2.63mm <sup>2</sup>	
<b>Geometry</b>	Star-Quad	Double-Spiral		Double Star-Quad		
<b>Dielectric</b>	N/A	PVC		Foamed-Polyethylene (For All Positive Conductors)		
<b>Noise-Dissipation</b>	Carbon-Based Noise-Dissipation	No		Carbon-Based Noise-Dissipation		
<b>Jacket</b>	Red Striped PVC	Black or White PVC	Black or White PVC	Black PVC with Red Stripes	Black PVC with Gloss Black Matte Stripes	Black PVC with Green Stripes
<b>Single BiWire Capable</b>	N/A	Yes				
<b>Length</b>	<b>UK Retail</b>	<b>UK Retail</b>	<b>UK Retail</b>	<b>UK Retail</b>	<b>UK Retail</b>	<b>UK Retail</b>
50m Spool	-	20.00/m	40.00/m	60.00/m	80.00/m	110.00/m
100m Spool	25.00/m	20.00/m	40.00/m	60.00/m	-	-

Termination "Pants" available for Type 5, Rocket 11/22/33/44/88, page 57.



Model	Rocket 33	Rocket 44	Rocket 88
<b>Metal</b>	Solid Perfect-Surface Copper (PSC) and Long-Grain Copper (LGC)	Solid Perfect-Surface Copper+ (PSC+) and Perfect-Surface Copper (PSC)	Solid Perfect-Surface Copper+ (PSC+)
<b>Gauge</b>	2.08mm <sup>2</sup>	2.62mm <sup>2</sup>	
<b>Geometry</b>	Double Star-Quad		
<b>Dielectric</b>	Foamed-Polyethylene (For All Positive Conductors)		
<b>Noise-Dissipation</b>	Carbon-Based Noise-Dissipation		
<b>Jacket</b>	Red/Black Braid	Silver/Black Braid	Green/Black Braid
<b>Single BiWire Capable</b>	Yes		
<b>Length</b>	<b>UK Retail</b>	<b>UK Retail</b>	<b>UK Retail</b>
50m Spool	60.00/m	80.00/m	110.00/m
100m Spool	60.00/m	-	-

Termination "Pants" available for Type 5, Rocket 33/44/88, page 57.

## SureGrip® Speaker Connectors

Fits up to 6.63mm<sup>2</sup> Speaker Cables



**SureGrip® 100 Banana**  
Direct-Silver or Gold over Beryllium-Copper

**Set of 8**  
UK Retail: 50.00

**Set of 12**  
UK Retail: 75.00

**Bag of 80**  
UK Retail: 500.00

**Bag of 120**  
UK Retail: 750.00

**SureGrip® 100 Multi-Spade**  
Direct-Silver or Gold Plating over Purple Copper

**Set of 8**  
UK Retail: 50.00

**Set of 12**  
UK Retail: 75.00

**Bag of 80**  
UK Retail: 500.00

**Bag of 120**  
UK Retail: 750.00

Allen Tool Included



**SureGrip® 300 Banana**  
Direct-Silver or Gold over Beryllium-Copper

**Set of 4**  
UK Retail: 50.00

**Tray of 40**  
UK Retail: 500.00

**SureGrip® 300 Multi-Spade**  
Direct-Silver or Gold Plating over Purple Copper

**Set of 4**  
UK Retail: 50.00

**Tray of 40**  
UK Retail: 500.00

Allen Tool Included

Black Labels Included



**500 Series Banana or Multi-Spade**  
Hanging-Silver directly over pure Purple Copper or Hanging-Gold directly over pure Purple Copper. Silver or Gold.

**Set of 4**  
UK Retail: 109.00

**Set of 6**  
UK Retail: 169.00

Combination Allen and Phillips Tool Included



**1000 Series Banana or Multi-Spade**  
Hanging-Silver directly over pure Red Copper.









**Set of 4**  
UK Retail: 189.00

**Set of 6**  
UK Retail: 279.00

Combination Allen and Phillips Tool Included

## Spade, Pin, and Banana Connectors

Supplied with Red and Black "Boots" (except 1002)

 <p><b>1410/S 1410/G</b> Direct-Silver Plated and Direct-Gold Plated Up to 2.08 mm<sup>2</sup> 4.76mm Binding Post</p> <p><b>Set of 4</b> UK Retail: 50.00</p>	 <p><b>1010/S 1010/G</b> Direct-Silver Plated and Direct-Gold Plated Up to 5.26 mm<sup>2</sup> 4.76mm Binding Post</p> <p><b>Set of 4</b> UK Retail: 70.00</p>	 <p><b>1414/S 1414/G</b> Direct-Silver Plated and Direct-Gold Plated Up to 2.08 mm<sup>2</sup> 6.35mm Binding Post</p> <p><b>Set of 4</b> UK Retail: 50.00</p>
 <p><b>1014/S 1014/G</b> Direct-Silver Plated and Direct-Gold Plated Up to 5.26 mm<sup>2</sup> 6.35mm Binding Post</p> <p><b>Set of 4</b> UK Retail: 50.00</p>	 <p><b>1056/S 1056/G</b> Direct-Silver Plated and Direct-Gold Plated Up to 5.26 mm<sup>2</sup> 7.94mm Binding Post</p> <p><b>Set of 4</b> UK Retail: 50.00</p>	 <p><b>P10M/S P10M/G</b> Hanging-Silver and Hanging Gold Up to 5.26 mm<sup>2</sup> 6.35mm and 7.94mm Binding Post</p> <p><b>Set of 4</b> UK Retail: 42.50</p>
 <p><b>BP10/S BP10/G</b> Direct-Silver Plated and Direct-Gold Plated Up to 5.26 mm<sup>2</sup> Bendable Pin Fits Almost Everything</p> <p><b>Set of 4</b> UK Retail: 35.00</p>	 <p><b>Crimp-BFA/S Crimp-BFA/G</b> Direct-Silver Plated and Direct-Gold Plated Up to 6.63 mm<sup>2</sup> Standard Banana Jack</p> <p><b>Set of 4</b> UK Retail: 35.00</p>	 <p><b>1002/S 1002/G</b> Direct-Silver Plated and Direct-Gold Plated Up to 6.63 mm<sup>2</sup> Standard Banana Jack</p> <p><b>Set of 4</b> UK Retail: 85.00</p>

## Termination "Pants" for Speaker Cables



Model	Full-Range	Single BiWire
	UK Retail	UK Retail
Rocket 11 Pants set/4	12.95	17.95
Rocket 22 Pants set/4	12.95	17.95
Rocket 33 Pants set/4	12.95	17.95
Rocket 44 Pants set/4	12.95	17.95
Rocket 88 Pants set/4	12.95	17.95
Type 5 Pants set/4	12.95	-

## CL3/FT4 In-Wall Rated Bulk Audio Interconnect Cables & Plugs

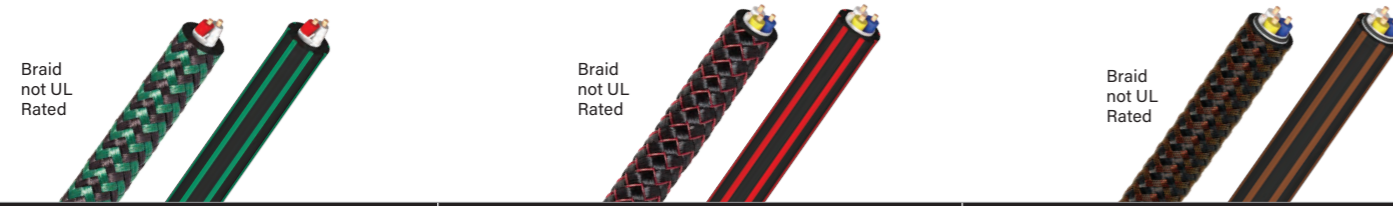

Model	Chicago	Red River	Mackenzie
<b>Metal</b>	Solid Long-Grain Copper (LGC)	Solid Perfect-Surface Copper (PSC)	Solid Perfect-Surface Copper+ (PSC+)
<b>Geometry</b>	Double-Balanced	Triple-Balanced (Separate Ground-Reference Conductor)	
<b>Dielectric</b>	Hard-Cell Foam		
<b>Noise-Dissipation</b>	Metal-Layer Noise-Dissipation		Carbon-Based Multi-Layer Noise-Dissipation
<b>Jacket</b>	Green/Black Braid or CL3 Black PVC with Green Stripes	Red/Black Braid or CL3 Black PVC with Red Stripes	Brown/Black Braid or CL3 Black PVC with Brown Stripes
<b>Length</b>	<b>UK Retail</b>	<b>UK Retail</b>	<b>UK Retail</b>
<b>50m</b>	-	-	<b>25.00m</b>
<b>100m</b>	<b>10.00/m</b>	<b>20.00/m</b>	-

Note: For spools, retail price per meter is listed.

### Field Termination Connectors

To download Chicago, Red River, and Mackenzie cable termination manuals, go to <https://www.audioquest.com/custom-install/manuals>



### Rivers Interconnect Crimper Tool

Required with either AudioQuest Chicago RCA, Red River and Mackenzie RCA or XLR plugs.



**Chicago RCA**  
Gold-Plated

**Set of 4**  
**UK Retail: 79.00**



**Red River RCA**  
Gold-Plated

**Set of 4**  
**UK Retail: 79.00**



**Red River XLR**  
Gold-Plated

**Set of 4**  
**UK Retail: 139.00**



**Mackenzie RCA**  
Hanging-Silver over Purple Copper

**Set of 4**  
**UK Retail: 99.00**



**Mackenzie XLR**  
Hanging-Silver over Purple Copper

**Set of 4**  
**UK Retail: 169.00**

## CL3/FT4 In-Wall Rated Bulk CAT6 and CAT7 Ethernet Cables & Plugs

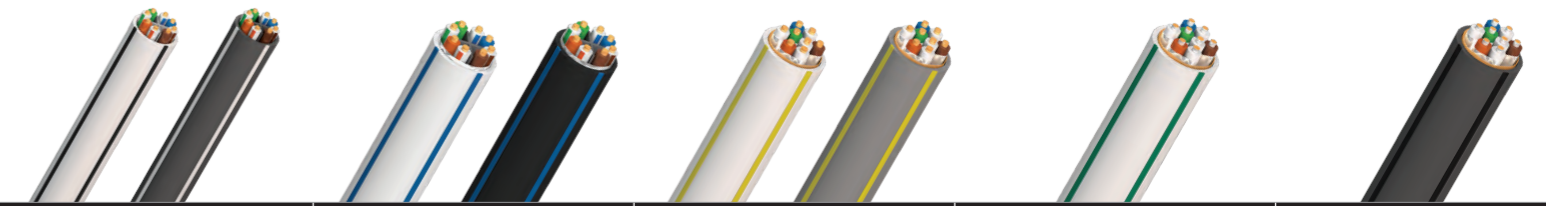

	CAT600 DCP	CAT600 FMJ	CAT700 Pearl	CAT700 Forest	CAT700 Carbon
<b>Metal</b>	Solid Long-Grain Copper (LGC)		Solid 0.5% Silver		Solid 5% Silver
<b>Shield</b>	N/A	Overall Shield	Overall Shield and Individual Pairs		
<b>Gauge</b>	0.26 mm <sup>2</sup>				
<b>Dielectric</b>	Solid High-Density Polyethylene		Hard-Cell Foam		
<b>Jacket</b>	CMG (CL3/FT4) Rated White PVC with Black Stripes or Dark Gray PVC with White Stripes	CMG (CL3/FT4) Rated White or Black PVC with Blue Stripes	CMG (CL3/FT4) Rated White or Medium Gray PVC with Yellow PVC	CMG (CL3/FT4) Rated White PVC with Green Stripes	CMG (CL3/FT4) Rated Dark Gray PVC with Black Stripes
<b>Length</b>	<b>UK Retail</b>	<b>UK Retail</b>	<b>UK Retail</b>	<b>UK Retail</b>	<b>UK Retail</b>
<b>152m</b>	-	<b>4.25/m</b>	<b>8.50/m</b>	<b>12.50/m</b>	<b>55.00/m</b>
<b>305m</b>	<b>3.25/m</b>	-	-	-	-

Note: For spools, retail price per meter is listed.

### CAT6/7 Connectors

To download CAT600 and CAT700 cable termination manuals, go to <https://www.audioquest.com/custom-install/manuals>



### Cat6/6a/7 Crimper Tool and Die

Required to terminate our Cat6/7 cables and connectors, includes Cat6 and Cat7 Die.



**Cat6 Die**  
Also sold separately



**Load Bar Connector Boot**

### CAT600 DCP Connectors

Fits **CAT600DCP** cable and **standard unshielded** Cat6 cables

**Each UK Retail: 1.50**   **Bag of 50 UK Retail: 75.00**



**Load Bar Connector Boot**

### CAT600 FMJ Connectors

Fits **CAT600FMJ, CAT700** and **standard shielded Cat6/Cat7** cables

**Each UK Retail: 3.25**   **Bag of 50 UK Retail: 162.50**



**Load Bar Connector Boot**

### CAT700 Connectors

Fits **CAT600FMJ, CAT700** and **standard shielded Cat6/Cat7** cables

**Each UK Retail: 3.50**   **Bag of 50 UK Retail: 175.00**



### CAT700 Telegärtner Male Connector

Fits all standard Cat6a/Cat7 cables

**Each UK Retail: 25.00**

## Installer Packs

### Cables and Accessories in Installer-Friendly bags instead of hanging boxes.

Installer Packs provide exactly what you need to get the job done. Each Pack includes a number of high-value, high-performance AudioQuest pieces and comes with convenient integrated labels that you can peel off and place on your invoice. No retail packaging, no garbage in your truck, no excess waste or cost.



### Audio Interconnect Cables

Packs of 5



	Tower	Golden Gate	Alpha-Snake
<b>Length</b>	<b>UK Retail per Cable</b>	<b>UK Retail per Cable</b>	<b>UK Retail per Pair</b>
0.5m	-	-	24.95
0.6m	34.95	99.00	-
1m	42.95	109.00	29.95
2m	49.95	129.00	34.95
3m	59.95	139.00	39.95

0.6m available in RCA - RCA only.  
1 - 3m available in RCA - RCA, 3.5mm - RCA, 3.5mm - 35mm.

### Optical Cables

Packs of 5



	Pearl	Forest	Cinnamon
<b>Length</b>	<b>UK Retail per Cable</b>	<b>UK Retail per Cable</b>	<b>UK Retail per Cable</b>
0.75m	29.95	46.95	69.00
1.5m	34.95	54.95	85.00
3m	49.95	84.95	129.00

Available in Full-to-Full configurations only.

### HDMI Cables

Packs of 5



	BlueBerry	Pearl 48	Forest 48
<b>Length</b>	<b>UK Retail per Cable</b>	<b>UK Retail per Cable</b>	<b>UK Retail per Cable</b>
0.6m	25.95	34.95	59.00
1m	29.95	39.95	69.00
1.5m	33.95	44.95	89.00
2m	38.95	49.95	99.00
3m	49.95	69.95	139.00
5m	89.95	169.95	249.00

BlueBerry meets the 18G bandwidth required for video up to 8K/30;  
Pearl 48, Forest 48, and Cinnamon 48 extend this capability up to 8K/60 and 4K/120.

### HDMI Adaptors

Packs of 5

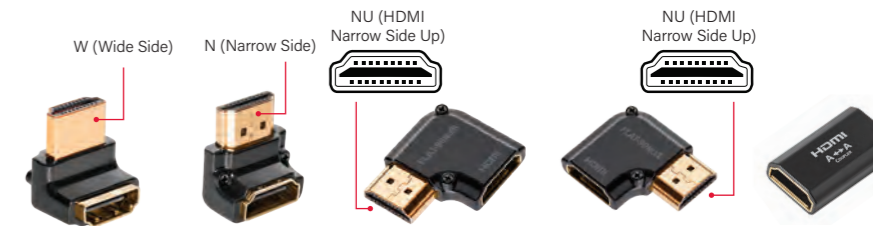

HDMI 90°/W	HDMI 90°/N	HDMI 90° NU/R	HDMI 90° NU/L	HDMI Coupler
<b>UK Retail Each</b>	<b>UK Retail Each</b>	<b>UK Retail Each</b>	<b>UK Retail Each</b>	<b>UK Retail Each</b>
16.95	16.95	16.95	16.95	16.95

### Audio Interconnect FLX-X RCA Splitters

Packs of 5



M22F	F22M
<b>UK Retail Each</b>	<b>UK Retail Each</b>
19.95	19.95

### AC Power C7 90° Adaptors

Packs of 10



E = Equal radius	U = Unequal radius
<b>UK Retail Each</b>	<b>UK Retail Each</b>
19.95	19.95

### Ethernet Cables (RJ/E)

Packs of 5



	Pearl	Forest	Cinnamon
<b>Length</b>	<b>UK Retail per Cable</b>	<b>UK Retail per Cable</b>	<b>UK Retail per Cable</b>
0.75m	34.95	65.00	99.00
1.5m	49.95	79.00	119.00
3m	69.95	109.00	149.00
5m	99.95	139.00	199.00

### Digital Coax Cables

Packs of 5



	Forest
<b>Length</b>	<b>UK Retail per Cable</b>
0.75m	39.95
1.5m	46.95
3m	64.95
5m	84.95

## AudioQuest Branded Point of Purchase (POP) Materials



Slat Wall Sign



Acrylic Wall Sign - Red



Acrylic Wall Sign - Black



Tent Card



Window Sticker



Cube Spool Holder

Rugged metal spool holder comes with convenient merchandising labels and accommodates almost any AQ spool.



In-Store Display Rack

Spool holder sold separately.

Dimensions: 193cm (h) x 89cm (w) x 33cm (d)



Standalone Display Rack

## AudioQuest Branded Promotional Items



Polo Shirt

Our versatile polo shirt looks great with anything. Classic black with a discreet silver AudioQuest logo.

Men's sizes: S-2XL; Women's sizes: S-XL.



T-Shirt

Our classic crewneck t-shirt is made from 100% lightweight, preshrunk cotton for a perfect fit that's as attractive as it is comfortable. Our t-shirt features a tasteful red AudioQuest logo against a solid black background.

Sizes: S-3XL



Chino Washed Cotton Baseball Cap

Our baseball cap has a durable 8-stitch bill for a long-lasting, contoured shape. The Velcro fastener provides easy adjustments for a perfect fit. Available in black with red AudioQuest logo and trim, this cap looks and feels great. One size fits all.



Beanie

Red, gray, and black, with our classic red AudioQuest logo, our stylish beanie is made from super-stretch, fine-gauge acrylic, for a warm, snug fit over your head and ears. The perfect accessory for those cooler days. One size fits all.



Pen

Take note: With its discreet AQ logo, piano-black lacquered tube, and chrome accents, this ballpoint pen has the looks to match the quality of your prose. Keep it in your AudioQuest backpack and take it with you wherever you go.



Water Bottle

Made by Specialized, this 769ml leak-proof water bottle has a self-sealing valve and features easy-to-squeeze BPA-free, recyclable plastic. Our distinct Wolves artwork is printed with a non-solvent based, CPSC-approved ink. Just aim and squeeze for clean, pure refreshment.



## AudioQuest Branded Promotional Items



### License Plate

It's all about the journey. Take your love for AudioQuest on the road with this license-plate frame. The clean, simple design features our red AudioQuest logo and "Experience the Difference" mantra set against a black background—perfect for any ride. Vroom!



### Backpack

Available in black with our black AudioQuest and Four Elements logos. Accommodates laptops with 13" screens and tablets. Made of nylon.



### Padded Backpack

Do no harm with our padded backpack. It features a discreet front-panel zipper, multiple internal pockets, and mesh side pockets for drinks and other items. A padded laptop insert safely accommodates screens up to 15". Mesh backing and straps are durable and comfortable, making the backpack as easy to carry as it is to wear.



### Tote Bag

This super-durable tote bag is made of water-repellent polyester and has a long strap that fits easily over a shoulder. Measuring 38cm x 36.5cm, its slim pocket is perfect for carrying AudioQuest merchandise—pens, tumblers, price books—and even an LP or two! The simple black-on-black design features a subtly stylish AQ logo.

## Index

### A

#### AC Power Cables

<i>Mistral AC Power Bulk Cable</i> .....	12
<i>NRG-X2</i> .....	11
<i>NRG-Y2</i> .....	11
<i>NRG-Z2</i> .....	11
<i>NRG-X3</i> .....	11
<i>NRG-Y3</i> .....	11
<i>NRG-Z3</i> .....	1
<i>Monsoon</i> .....	12
<i>Monsoon XTRM</i> .....	12
<i>Blizzard</i> .....	12
<i>Blizzard XTRM</i> .....	12
<i>Silver Cloud</i> .....	12
<i>Silver Cloud XTRM</i> .....	12
<i>Thunder (High-Current)</i> .....	13
<i>Tornado (High-Current)</i> .....	13
<i>Tornado (Source)</i> .....	13
<i>Hurricane (High-Current)</i> .....	13
<i>Hurricane (Source)</i> .....	13
<i>FireBird (High-Current)</i> .....	13
<i>FireBird (Source)</i> .....	13
<i>Dragon (High-Current)</i> .....	13
<i>Dragon (Source)</i> .....	13

#### AC Power Conditioners

<i>Niagara 1200</i> .....	9
<i>Niagara 3000</i> .....	9
<i>Niagara 5000</i> .....	9
<i>Niagara 7000</i> .....	9

#### Adaptors

<i>C7 90° Adaptor Kit</i> .....	14
<i>See also Installer Packs, pg. 60</i>	
<i>DragonTail A to C Adaptor</i> .....	7
<i>DragonTail USB A to C Adaptor</i> .....	7
<i>DragonTail USB A to Micro Adaptor</i> ..	7
<i>DVI-IN to HDMI-OUT Adaptor</i> .....	40
<i>F-90° Adaptor</i> .....	49
<i>FLX-Mini/RCA Adaptor</i> .....	30
<i>F to BNC Male Adaptor</i> .....	49
<i>F to RCA Male Adaptor</i> .....	49
<i>Hard Mini/RCA Adaptor</i> .....	30
<i>HDMI 90° /W Adaptor</i> .....	40
<i>See also Installer Packs, pg. 61</i>	
<i>HDMI 90°/N Adaptor</i> .....	40
<i>See also Installer Packs, pg. 61</i>	
<i>HDMI 90° NU/L Flat Adaptor</i> .....	40
<i>See also Installer Packs, pg. 61</i>	
<i>HDMI 90° NU/R Flat Adaptor</i> .....	40
<i>See also Installer Packs, pg. 61</i>	

<i>IEC90/1</i> .....	14
<i>IEC90/2</i> .....	14
<i>M21F-90 Adaptor</i> .....	30
<i>Mini Display Port to HDMI 4K Adaptor</i> .....	40
<i>Optical Mini Adaptor</i> .....	44
<i>RCA - BNC Adaptor</i> .....	49
<i>RCA to BNC</i> .....	45
<i>USB 3.1 C to A Adaptor</i> .....	43
<i>USB B - Micro B 2.0 Adaptor</i> .....	43
<i>USB Mini B - Micro B 2.0 Adaptor</i> ..	43

#### AES/EBU (Balanced) Cables

<i>Carbon</i> .....	46
<i>Wild</i> .....	46
<i>WEL Signature</i> .....	46

#### Audio Interconnect Cables

<i>Tower</i> .....	27
<i>See also Installer Packs, pg. 60</i>	
<i>Evergreen</i> .....	27
<i>Golden Gate</i> .....	27
<i>See also Installer Packs, pg. 60</i>	
<i>Big Sur</i> .....	27
<i>Sydney</i> .....	27
<i>Yosemite</i> .....	27
<i>Angel</i> .....	27
<i>Chicago</i> .....	28
<i>See also Bulk Cables, pg. 58</i>	
<i>Red River</i> .....	28
<i>See also Bulk Cables, pg. 58</i>	
<i>Mackenzie</i> .....	28
<i>See also Bulk Cables, pg. 58</i>	
<i>Yukon</i> .....	28
<i>Black Beauty</i> .....	28
<i>Pegasus</i> .....	28
<i>ThunderBird</i> .....	29
<i>FireBird</i> .....	29
<i>Dragon</i> .....	29
<i>Alpha-Snake, Installer Packs</i> .....	60

### B

#### BiWire Jumpers

<i>Bare Naked BiWire Jumpers</i> .....	25
<i>ThunderBird</i> .....	25
<i>Dragon</i> .....	25

#### Bulk Cables

<i>HD6 Pearl</i> .....	52
<i>HD6 Forest</i> .....	52
<i>HD6 Carbon</i> .....	52
<i>ITA-1/1</i> .....	52

<i>ITA-3/3</i> .....	52
<i>ITA-5/5</i> .....	52
<i>SLiP/DB-16/2</i> .....	54
<i>SLiP/DB-16/4</i> .....	54
<i>SLiP/DB-14/2</i> .....	54
<i>SLiP/DB-14/4</i> .....	54
<i>SLiP XTRM 14/2</i> .....	54
<i>SLiP XTRM 14/4</i> .....	54
<i>G2</i> .....	55
<i>X2</i> .....	55
<i>Q2</i> .....	55
<i>Type 5</i> .....	54
<i>Rocket 11</i> .....	54
<i>Rocket 22</i> .....	54
<i>Rocket 33</i> .....	55
<i>Rocket 44</i> .....	55
<i>Rocket 88</i> .....	55
<i>Chicago</i> .....	58
<i>Mackenzie</i> .....	58
<i>Red River</i> .....	58
<i>CAT600 DCP</i> .....	59
<i>CAT600 FMJ</i> .....	59
<i>CAT700 Pearl</i> .....	59
<i>CAT700 Forest</i> .....	59
<i>CAT700 Carbon</i> .....	59

### C

#### Cable Clips

#### Cable Risers

<i>Fog Lifters</i> .....	14, 25, 48
--------------------------	------------

#### Cleaner

<i>CleanScreen Kit</i> .....	48
------------------------------	----

#### Connectors

<i>507 Series Banana</i> .....	56
<i>1000 Series Banana</i> .....	56
<i>Banana Connectors</i> .....	56
<i>CAT600 DCP Connectors</i> .....	59
<i>CAT600 FMJ Connectors</i> .....	59
<i>CAT700 Connectors</i> .....	59
<i>CAT700 Telegärtner Male Connector</i>	59
<i>Chicago RCA</i> .....	58
<i>Color Bands for 18 and 24 AWG ITC Connectors</i> .....	53
<i>F-90°</i> .....	50
<i>ITC-18G/BNC</i> .....	53
<i>ITC-18G/F</i> .....	53
<i>ITC-18G/RCA</i> .....	53
<i>ITC-24G/BNC</i> .....	53

<i>ITC-24G/F</i> .....	53
<i>ITC-24G/RCA</i> .....	53
<i>Mackenzie RCA</i> .....	58
<i>Mackenzie XLR</i> .....	58
<i>Pin Connectors</i> .....	57
<i>RCA-90°</i> .....	50
<i>RCA-300</i> .....	50
<i>RCA-800</i> .....	50
<i>Red River RCA</i> .....	58
<i>Red River XLR</i> .....	58
<i>Spade Connectors</i> .....	57
<i>SureGrip 100 Banana</i> .....	56
<i>SureGrip 100 Multi-Spade</i> .....	56
<i>SureGrip 300 Banana</i> .....	56
<i>SureGrip 300 Multi-Spade</i> .....	56
<i>XLR Connectors</i> .....	50

### Couplers

<i>F - F Coupler</i> .....	49
<i>HDMI A - A Coupler</i> .....	40
<i>See also Installer Packs, pg. 61</i>	
<i>RCA - RCA Coupler</i> .....	30

### D

#### DBS Pack, Level-X

#### Digital Coax Cables

<i>Forest</i> .....	45
<i>See also Installer Packs, pg. 61</i>	
<i>Cinnamon</i> .....	45
<i>Carbon</i> .....	45
<i>Coffee</i> .....	45
<i>Diamond</i> .....	45
<i>Wild</i> .....	45
<i>WEL Signature</i> .....	45

#### DragonFly

<i>Cobalt</i> .....	7
---------------------	---

### E

#### Ethernet Cables (RJ/E)

<i>Pearl</i> .....	47
<i>See also Installer Packs, pg. 61</i>	
<i>Forest</i> .....	47
<i>See also Installer Packs, pg. 61</i>	
<i>Cinnamon</i> .....	47
<i>See also Installer Packs, pg. 61</i>	
<i>Vodka</i> .....	47
<i>Diamond</i> .....	47

### F

#### Fog Lifters

.....	14, 25, 48
-------	------------

# Index

## G

### GroundGoody

<i>Black Hole</i> .....	35
<i>ThunderBird</i> .....	35
<i>Dragon</i> .....	35

## H

### HDMI Cables

<i>BlueBerry</i> .....	38
<i>See also Installer Packs, pg. 61</i>	
<i>Pearl 48</i> .....	38
<i>See also Installer Packs, pg. 61</i>	
<i>Forest 48</i> .....	38
<i>See also Installer Packs, pg. 61</i>	
<i>Cinnamon 48</i> .....	38
<i>Carbon 48</i> .....	38
<i>Vodka 48</i> .....	38
<i>ThunderBird 48</i> .....	38
<i>FireBird 48</i> .....	38
<i>Dragon 48</i> .....	38
<i>Pearl 18 Long Distance</i> .....	39
<i>Forest 18 Long Distance</i> .....	39
<i>Root Beer 18 Optical</i> .....	39
<i>Cherry Cola 48 Optical</i> .....	39
<i>Vodka eARC</i> .....	39
<i>ThunderBird eARC</i> .....	39
<i>Dragon eARC</i> .....	39

### Headphone Accessories

<i>Headphone Plug Adaptor</i> .....	35
<i>HL-5 Headshell Leads</i> .....	35
<i>NightBird Headphone Cable</i> .....	35
<i>Perch Headphone Stand</i> .....	35

## J

<b>JitterBug FMJ</b> .....	7
<i>See also USB Accessories, pg. 43</i>	

## N

### Noise-Stopper Caps

<i>HDMI Noise-Stopper Caps</i> .....	51
<i>RCA Noise-Stopper Caps</i> .....	51
<i>RJ45 Noise-Stopper Caps</i> .....	51
<i>USB-A Noise-Stopper Caps</i> .....	51
<i>XLR Input (Female) Noise-Stopper Caps</i> .....	51
<i>XLR Output (Male) Noise-Stopper Caps</i> .....	51

## O

### Optical Cables

<i>Pearl</i> .....	44
<i>Forest</i> .....	44
<i>Cinnamon</i> .....	44
<i>Carbon</i> .....	44
<i>Vodka</i> .....	44

## P

### POP Materials

<i>Acrylic Wall Sign - Black, Red</i> .....	62
<i>Cube Spool Holder</i> .....	62
<i>Display Rack, In-Store</i> .....	62
<i>Display Rack, Standalone</i> .....	62
<i>Slat Wall Sign</i> .....	62
<i>Tent Card</i> .....	62
<i>Window Sticker</i> .....	62

### PreAmp Jumpers..... 30

### Promotional Items

<i>Backpack</i> .....	64
<i>Backpack, Padded</i> .....	64
<i>Baseball Cap</i> .....	63
<i>Beanie</i> .....	63
<i>Hooded Jacket</i> .....	63
<i>License Plate</i> .....	64
<i>Pen</i> .....	63
<i>Polo Shirt</i> .....	63
<i>Tote Bag</i> .....	64
<i>T-Shirt</i> .....	63
<i>Tumbler</i> .....	63
<i>Water Bottle</i> .....	63

## Q

### Q-Feet, SorboGel..... 48

## R

### Record Brushes

<i>Gold Record Brush</i> .....	35
<i>SilverRecord Brush</i> .....	35

## S

### Solder, Silver..... 52

### Sorbothane Self-Stick Sheet..... 58

### Speaker Cables

<i>Q2</i> .....	18
<i>See also Bulk Cables, pg. 55</i>	

<i>Type 5</i> .....	18
---------------------	----

*See also Bulk Cables, pg. 54*

<i>Type 9</i> .....	18
---------------------	----

<i>Type 9+DBS</i> .....	18
-------------------------	----

<i>Rocket 11</i> .....	19
------------------------	----

*See also Bulk Cables, pg. 54*

<i>Rocket 22</i> .....	19
------------------------	----

*See also Bulk Cables, pg. 54*

<i>Rocket 33</i> .....	19
------------------------	----

*See also Bulk Cables, pgs. 54, 55*

<i>Rocket 44</i> .....	19
------------------------	----

*See also Bulk Cables, pgs. 54, 55*

<i>Rocket 88</i> .....	19
------------------------	----

*See also Bulk Cables, pgs. 54, 55*

<i>Robin Hood ZERO</i> .....	20
------------------------------	----

<i>Robin Hood BASS</i> .....	20
------------------------------	----

<i>Robin Hood ZERO BiWire COMBO</i> .....	20
---	----

<i>Robin Hood SILVER</i> .....	20
--------------------------------	----

<i>Robin Hood SILVER BiWire COMBO</i> .....	20
---	----

<i>William Tell ZERO</i> .....	21
--------------------------------	----

<i>William Tell BASS</i> .....	21
--------------------------------	----

<i>William Tell ZERO BiWire COMBO</i> .....	21
---	----

<i>William Tell SILVER</i> .....	21
----------------------------------	----

<i>William Tell SILVER BiWire COMBO</i> .....	21
---	----

<i>ThunderBird ZERO</i> .....	22
-------------------------------	----

<i>ThunderBird BASS</i> .....	22
-------------------------------	----

<i>ThunderBird ZERO BiWire COMBO</i> .....	22
--	----

<i>FireBird ZERO</i> .....	23
----------------------------	----

<i>FireBird BASS</i> .....	23
----------------------------	----

<i>FireBird BiWire COMBO</i> .....	23
------------------------------------	----

<i>Dragon ZERO</i> .....	23
--------------------------	----

<i>Dragon BASS</i> .....	23
--------------------------	----

<i>Dragon BiWire COMBO</i> .....	23
----------------------------------	----

### Splitters

<i>FLX-Mini Splitter</i> .....	30
--------------------------------	----

<i>FLX-X RCA Splitter</i> .....	30
---------------------------------	----

*See also Installer Packs, pg. 60*

<i>F to 2F Splitter</i> .....	49
-------------------------------	----

<i>F to 4F Splitter</i> .....	49
-------------------------------	----

<i>Hard RCA Splitter</i> .....	30
--------------------------------	----

### Subwoofer Cables

<i>Black Lab</i> .....	31
------------------------	----

<i>Greyhound</i> .....	31
------------------------	----

<i>Irish Red</i> .....	31
------------------------	----

<i>Boxer</i> .....	31
--------------------	----

<i>Husky</i> .....	31
--------------------	----

## T

### Termination Pants

<i>Rocket 11</i> .....	57
------------------------	----

<i>Rocket 22</i> .....	57
------------------------	----

<i>Rocket 33</i> .....	57
------------------------	----

<i>Rocket 44</i> .....	57
------------------------	----

<i>Rocket 88</i> .....	57
------------------------	----

<i>Type 5</i> .....	57
---------------------	----

<i>Type 9</i> .....	57
---------------------	----

### Tonearm Cables

<i>Golden Gate</i> .....	32
--------------------------	----

<i>Yosemite</i> .....	32
-----------------------	----

<i>Angel</i> .....	32
--------------------	----

<i>WEL Signature Limited Edition</i> .....	32
--	----

### Tools

<i>AQ Ratchet Crimper Tool</i> .....	52
--------------------------------------	----

<i>Binding-Post Wrench</i> .....	49
----------------------------------	----

<i>Cat6/6a/7 Crimper Tool and Die</i> .....	52, 59
---	--------

<i>Cat6 Die</i> .....	52, 59
-----------------------	--------

<i>Ideal Articulated Stripper</i> .....	52
---	----

<i>ITC One-Step Stripper for 18 and 24 AWG</i> .....	53
--	----

<i>Klein Cable Cutter</i> .....	52
---------------------------------	----

<i>Klein Crimper Tool</i> .....	52
---------------------------------	----

<i>Paladin Jacket Stripper</i> .....	52
--------------------------------------	----

<i>Rivers Interconnect Crimper Tool</i> .....	52, 58
---	--------

<i>Wire Stripper/Cutter/Plier Combo Tool</i> .....	52
--	----

### Turntable Cables

<i>Golden Gate</i> .....	33
--------------------------	----

<i>Yosemite</i> .....	33
-----------------------	----

<i>Angel</i> .....	33
--------------------	----

<i>WEL Signature Limited Edition</i> .....	33
--	----

## U

### USB Cables

<i>Pearl</i> .....	42
--------------------	----

<i>Forest</i> .....	42
---------------------	----

<i>Cinnamon</i> .....	42
-----------------------	----

<i>Carbon</i> .....	42
---------------------	----

<i>Coffee</i> .....	42
---------------------	----

<i>Diamond</i> .....	42
----------------------	----

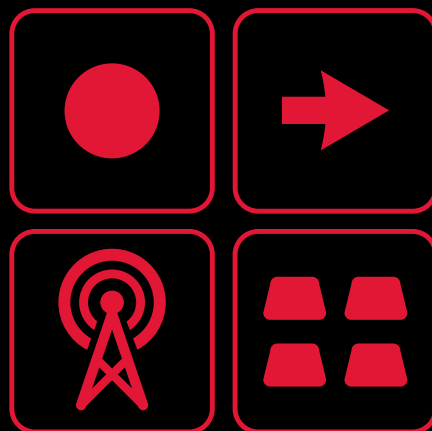

**audioquest®**

**[www.audioquest.com](http://www.audioquest.com)**  
**Tel 01249 848873**