

INSTRUCTION MANUAL

SPECIFICATIONS

Display Size: 60" to 100"

Maximum Load: 68 kg (150 lbs)

Mounting Pattern: 600 mm x 400 mm (23.6" x 15.7") max

Tilt Range: 2° up to 10° down

Pan/Swivel Range: up to 180°

Profile: 7.1 cm to 64.3 cm (2.8" to 25.3")

BOX CONTENTS

- Mount (x1)
- Mount Arm (x2)
- Instruction Manual (x1)
- Hardware Kit (x1)

WARNINGS

- 1 Read these instructions before you begin.** If you are unsure of any part of the process, contact a professional contractor or installer for assistance. Improper installation can result in injury or damage.
- 2** The wall or mounting surface must be capable of supporting the combined weight of the mount and the display; if not, the structure must be reinforced.
- 3** Locate pipes, wires, or any other hazards in the wall where you wish to install the mount before drilling.
- 4** Safety gear and proper tools must be used. Failure to do so can result in injury or damage.
- 5** Two people are recommended for installation. Do not attempt to lift a heavy display without assistance.
- 6** Follow all instructions and recommendations regarding adequate ventilation and suitable locations for mounting your display. Consult the owner's manual for your particular display for more information.













WARNINGS (continued)

- ⚠ CAUTION:** This wall mount is intended for use only with the maximum weight of 150 lbs. Use with heavier than the maximum weights indicated may result in instability causing possible injury.

TOOLS REQUIRED

- Phillips Head Screw Driver
- Ratchet or Driver with a 1/2" Socket
- Electric or Portable Drill
- 1/4" Drill Bit and Stud Finder for Drywall Installation
- 3/8" Masonry Bit for Concrete Installation
- Level

HARDWARE KIT

- | | |
|---|---|
| (A) M8 x 63 Lag Bolt (x4) | (I) M8 x 30 Screw (x4) |
|  |  |
| (B) Lag Bolt Washer (x4) | (J) M8 x 50 Screw (x4) |
|  |  |
| (C) Concrete Anchor (x4) | (K) M8 Washer (x4) |
|  |  |
| (D) M4 x 15 Screw (x4) | (L) Small Spacer (x4) |
|  |  |
| (E) M5 x 15 Screw (x4) | (M) large Spacer (x4) |
|  |  |
| (F) M5 Washer (x4) | |
|  | |
| (G) M6 x 15 Screw (x4) | |
|  | |
| (H) M8 x 15 Screw (x4) | |
|  | |

INSTALLATION

Part 1A – Mounting to the Wall (Drywall)

IMPORTANT! The mount must be secured to at least two wood studs no less than 16" apart. The studs must be capable of supporting the combined weight of the mount and display.

- 1** Use a high quality stud finder to locate two studs on the wall where you wish to install your mount. Mark both edges of each stud to help identify the exact center.

NOTE: Use the center of each stud to avoid cracking or splitting the wood.

- 2** Place the mount against the wall over the marked studs with the arrow on the mount pointing up. Make sure it is level.

- 3** While another person holds the mount in place, mark four locations (two per stud) for securing the mount to the wall (see Fig. 1).

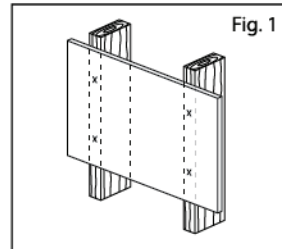

Fig. 1

- 4** Set the mount aside and drill a 1/4" pilot hole at each marked location.

- 5** Attach the mount to the wall with the arrow pointing up using the lag bolts (A) and washers (B) provided (see Fig. 2). **Do not release the mount until all bolts are secure.** Ensure that the mount remains level.

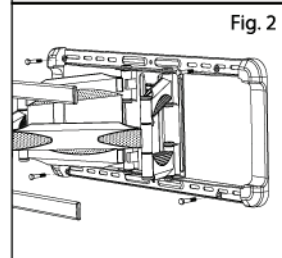

Fig. 2

Part 1B – Mounting to the Wall (Concrete)

IMPORTANT! For safety reasons, the concrete wall must be capable of supporting the combined weight of the mount and the display.

- 1** Place the mount against the wall in the desired location with the arrow on the mount pointing up. Make sure it is level.

Part 1B – Mounting to the Wall (Concrete) (continued)

- 2 While another person holds the mount in place, mark four locations for securing the mount to the wall (see Fig. 3).
- 3 Set the mount aside and drill a 3/8" hole at each marked location. Remove any excess dust from the holes.

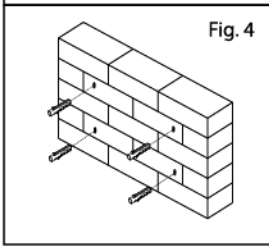
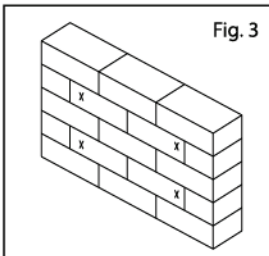

- 4 Insert a concrete anchor (C) into each hole so that it is flush with the concrete surface (see Fig. 4). A hammer can be used to lightly tap the anchors into place if necessary.

- 5 Attach the mount to the wall with the arrow pointing up using the lag bolts (A) and washers (B) provided (see Fig. 3). **Do not release the mount until all bolts are secure.** Ensure that the mount remains level.

Part 2 – Attaching the Mount Arms to the Display

IMPORTANT! Use extra care during this part of the installation to avoid damaging your display.

NOTE: This mount comes with a variety of screw lengths and diameters to accommodate different display models. Not all of the hardware in the kit will be used. If you cannot find the appropriate screw size in the kit provided, consult with the manufacturer of your display or a professional installer.

- 1 Determine the correct length of screw to use by examining the back of your display:
 - A If the back of your display is flat and the mounting holes are flush with the surface, use the shorter screws (D, E G or H) from the hardware kit.
 - B If the back of your display is curved or if additional space is needed between the display and the mount, use the longer screws.
- 2 Determine the correct diameter of screw to use by carefully trying one of each size (M4, M5, M6 and M8) from the hardware kit. **Do not force any of the screws – if you feel resistance stop immediately and try a smaller diameter screw.**

Part 2 – Attaching the Mount Arms to the Display (continued)

- 3 Attach the mount arms to the back of your display using the screws identified in steps 1 and 2 (see Fig. 5):
 - A If you are using the M4 and M5 screws you will need to use the M5 Washers (F). If you are using M6 and M8 screws, you will need to use the M8 washers (K).
 - B If you are using the longer screws, you may also need to use spacers (L or M).

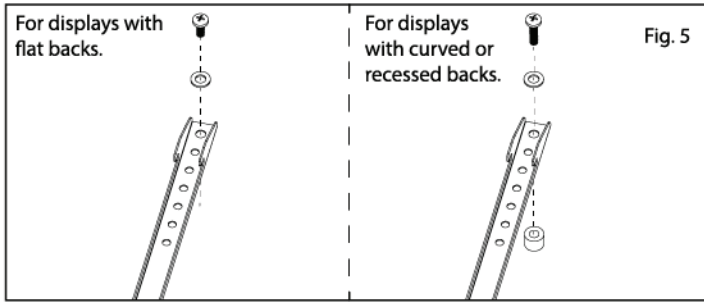

Part 3 – Final Assembly

- 1 With the help of another person, carefully lift your display and place it on the mount. **Do not release the display until the mount arms have securely hooked onto the mount.**
- 2 Close the safety latch at the bottom of each arm. Each latch will automatically lock when fully closed (see Fig. 6).

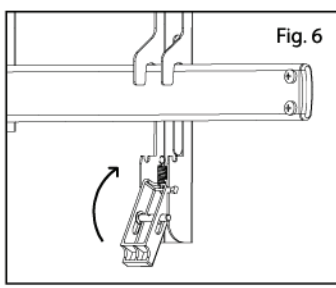

IMPORTANT! The latches must be closed and locked at all times to prevent the display from being accidentally knocked from the mount.

- 3 Cables can be routed through the channels located on the bottom of the mount. Make sure none of the cables can be pinched during operation of the mount.

OPERATION AND ADJUSTMENT

- 1 To change the tilt angle of your display, have one person hold the display firmly in place while another person loosens the tilt knob (see Fig. 7). Once loosened, move your display to the desired position, and then re-tighten the knob. **Do not release the display until the knob is fully tightened.**

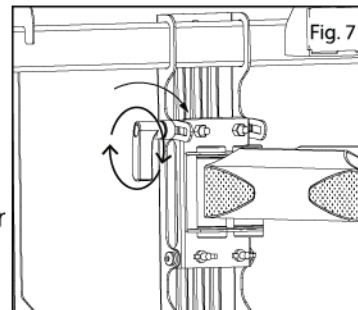

- 2 Swivel adjustments can be made by moving the display to the desired position. Be careful that fingers or cables do not get pinched when moving the mount.

- 3 Level correction adjustments can be made by rotating the display in the needed direction. If it is too difficult to turn the display or if the display does not stay in position, adjust the tension of the two wing nuts located behind the faceplate. Adjust the two nuts evenly (see Fig. 8).

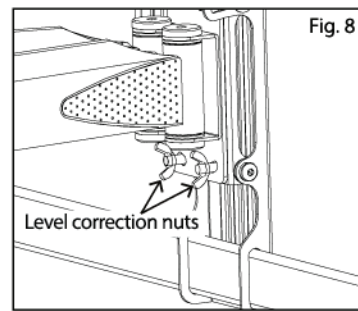

IMPORTANT! Never fully loosen or remove the level correction nuts.

- 4 Periodically clean your mount with a soft, dry cloth. Inspect all screws and hardware at regular intervals to ensure that no connections have become loose over time. Re-tighten as needed.