

# HERO

## / Join the GoPro Movement

---



facebook.com/GoPro



youtube.com/GoPro



twitter.com/GoPro



instagram.com/GoPro

To download this user manual in a different language, visit **[gopro.com/support](https://gopro.com/support)**.

Pour télécharger ce manuel de l'utilisateur dans une autre langue, rendez-vous sur **[gopro.com/support](https://gopro.com/support)**.

Wenn Sie dieses Benutzerhandbuch in einer anderen Sprache herunterladen möchten, besuchen Sie **[gopro.com/support](https://gopro.com/support)**.

Per scaricare questo manuale utente in un'altra lingua, visita **[gopro.com/support](https://gopro.com/support)**.

Para descargar este manual de usuario en otro idioma, visite **[gopro.com/support](https://gopro.com/support)**.

Para baixar este manual do usuário em outro idioma, acesse **[gopro.com/support](https://gopro.com/support)**.

このユーザーマニュアルの他言語版をダウンロードするには、**[gopro.com/support](https://gopro.com/support)**にアクセスしてください。

若要下載其他語言版本的使用說明書，請前往：**[gopro.com/support](https://gopro.com/support)**。

如需下載本用戶手冊的其他語言版本，請訪問**[gopro.com/support](https://gopro.com/support)**。

## / Table of Contents

---

Optional Accessories	6
The Basics	8
Getting Started	10
Camera Status Screen	17
Camera Icons	18
Camera Menus	19
Camera Modes	20
Video Mode	21
Photo Mode	22
Burst Mode	23
Time Lapse Mode	24
Settings Mode	25
Minimum System Requirements	32
Transferring and Playing Back Files	33
Battery	34
Important Messages	37
Camera Housing	39
Using the Mounts	42

## / Table of Contents

---

Frequently Asked Questions	45
Customer Support	46
Trademarks	46
Regulatory Information	46



Head Strap + QuickClip



Chesty (Chest Harness)



Suction Cup



Jaws: Flex Clamp



Surfboard Mounts



Bodyboard Mount

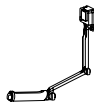

3-Way



Tripod Mounts



Helmet Front Mount



Side Mount

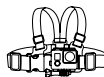

Junior Chesty (Chest Harness)



Floaty Backdoor



Handlebar/Seatpost/  
Pole Mount

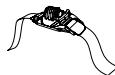

Vented Helmet Strap Mount



Fetch (Dog Harness)

See more at  
[gopro.com](http://gopro.com).

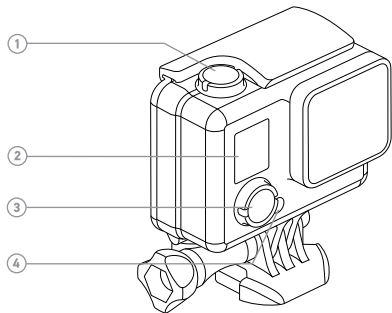

- 1. Shutter/Select Button
- 2. Camera Status Screen

- 3. Power/Mode Button
- 4. Camera Status Light

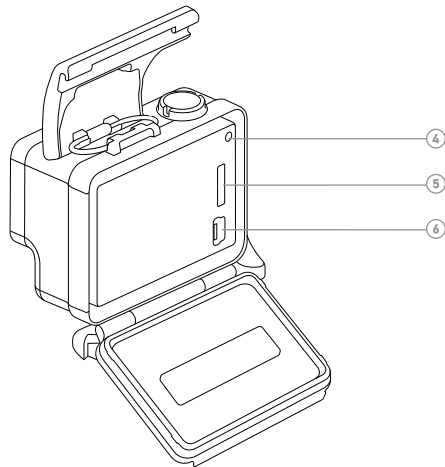

- 5. microSD Card Slot  
(microSD card sold separately)
- 6. Mini-USB Port

### CHARGING THE BATTERY

1. Open the backdoor of the housing.

*Note: Your HERO camera, battery, and housing are integrated. You cannot remove the camera from the housing, or remove the battery from the camera.*

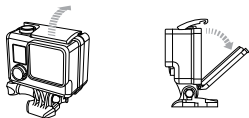

2. Charge the battery by connecting the camera to a computer or other USB charging adapter with the included USB cable.

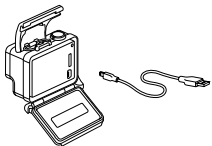

**NOTICE:** Only use USB charging adapters marked 5V 1A. If you do not know the voltage and amperage of your charger, use the included USB cable to charge the camera from your computer.

When charging with a computer, be sure that the computer is connected to a power source. If the camera status light does not turn on or you do not see the charging indicator, use a different USB port.

For fastest charging, make sure the camera is powered off after connecting it to a computer or USB charging adapter. The camera status light turns on during charging and turns off when charging is complete.

The integrated lithium-ion battery comes partially charged. No damage occurs to the camera or battery if used prior to a full charge.

For more battery information, see [Battery](#) (page 34).



**WARNING:** Use caution when using your GoPro as part of your active lifestyle. Always be aware of your surroundings to avoid injury to yourself and others. Abide by all local laws when using your GoPro and related mounts and accessories.

### INSERTING + REMOVING MICROSD CARDS

The HERO camera is compatible with microSD, microSDHC, and microSDXC memory cards (sold separately) up to 32GB capacity. You must use a microSD card with a Class 10 or a UHS-1 rating. GoPro recommends using brand name memory cards for maximum reliability in high-vibration activities.



#### To Insert the microSD Card:

Slide the memory card into the card slot with the label facing the GoPro logo on the back of the camera.

When fully inserted, the card clicks into place.

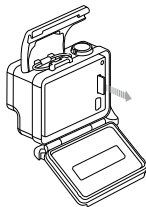

#### To Remove the microSD Card:

Place your fingernail against the edge of the memory card and lightly press it further into the camera.

The card springs out far enough to be removed.

**NOTICE:** Use care when handling memory cards. Avoid liquids, dust, and debris. As a precaution, power off the camera before inserting or removing the card. Check manufacturer guidelines regarding use in acceptable temperature ranges.

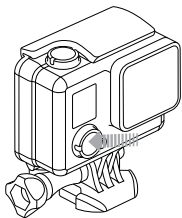

#### POWERING ON + OFF

##### To Power On:

Press the **Power/Mode** button once. The camera status lights flash three times and the sound indicator emits three beeps. When the camera status screen displays information, your camera is on.

##### To Power Off:

Press and hold the **Power/Mode** button for two seconds. The camera status lights flash several times and the sound indicator emits seven beeps.

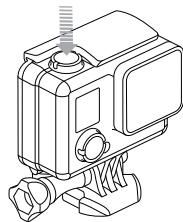

---

**PRO TIP:** You can quickly turn your camera on and immediately being capturing video or Time Lapse photos just by pressing the **Shutter/Select** button. Press and release for video, press and hold for 2 seconds for Time Lapse photos. For details, see [QuikCapture](#) (page 29).







### CAMERA SOFTWARE UPDATES

To get the latest features and best performance from your HERO camera, make sure you are using the most current camera software. You can update your camera software using GoPro software. For more info, visit [gopro.com/getstarted](https://gopro.com/getstarted).

### CAMERA DEFAULT SETTINGS

The HERO camera powers up with the following default settings:

	Video	720p60 SuperView, Auto Low Light
	Photo	5MP
	Burst	10 photos in 2 seconds (5 fps)
	Time Lapse	0.5 seconds
	QuikCapture	On

**PRO TIP:** To change your **Video** or QuikCapture settings, see [Settings Mode](#) (page 25).

Your HERO features a status screen on the front of the camera.

### CAMERA STATUS SCREEN

The camera status screen displays the following information about modes and settings:

1. Camera Modes/FOV (field of view)
2. Spot Meter (when Spot Meter is turned on)
3. Resolution/fps (frames per second)
4. Time Lapse Interval Setting (not shown)
5. Counter
6. Time/Storage/Files
7. Battery Life

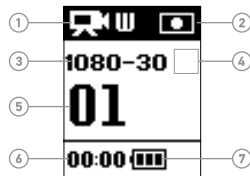

*Note: The icons that appear on the camera status screen vary by mode.*

## / Camera Icons

### Camera Modes

 Video

 Photo

 Burst

 Time Lapse

 Settings

### Settings

 Resolution

 Spot Meter

 Upside Down

 QuikCapture

 NTSC/PAL

 LEDs

 Beeps

 Date/Time

 Delete



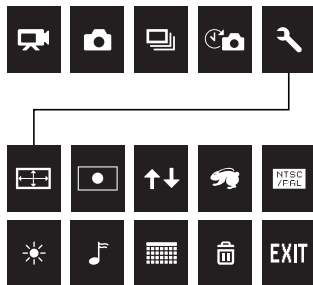

**EXIT** Exit

## / Camera Menus



The HERO features several camera modes. To display the modes, press the **Power/Mode** button repeatedly.

These modes appear:

	Video (default)	Record video
	Photo	Capture a single photo
	Burst	Capture 10 photos in 2 seconds
	Time Lapse	Capture a photo every 0.5 seconds
	Settings	Adjust camera settings

### CAPTURING VIDEO

To capture video, verify that the camera is in **Video** mode. If the **Video** icon [] does not appear in the upper left on your camera status screen, press the **Power/Mode** button repeatedly until it appears.

#### To Start Recording:

Press the **Shutter/Select** button. The camera emits one beep and the camera status lights flash while recording.

#### To Stop Recording:

Press the **Shutter/Select** button. The camera status lights flash three times and the camera emits three beeps to indicate recording has stopped.

If the memory card is full or the battery is out of power, your camera automatically stops recording. Your video is saved before the camera powers off.

---

**PRO TIP:** With QuikCapture, you can quickly turn your camera on and immediately begin capturing video just by pressing the **Shutter/Select** button. To turn off QuikCapture, see [QuikCapture](#) (page 29).

In **Photo** mode, you can capture photos at a resolution of 5MP with Ultra Wide FOV.

### CAPTURING A PHOTO

To capture a photo, verify that the camera is in **Photo** mode. If the **Photo** icon [  ] does not appear in the upper left on your camera status screen, press the **Power/Mode** button repeatedly until it appears.

#### To Capture a Photo:

Press the **Shutter/Select** button. The camera beeps two times, the camera status lights flash and the counter on the camera status screen increases by one.

With Burst mode, you can capture 10 photos in 2 seconds (5 fps).

### CAPTURING BURST PHOTOS

To capture a **Burst** photo series, verify that the camera is in **Burst** mode. If the **Burst** icon [  ] does not appear in the upper left on your camera status screen, press the **Power/Mode** button repeatedly until it appears.

#### To Capture Burst Photos:

Press the **Shutter/Select** button. The camera status lights flash and the camera beeps multiple times. The counter on the camera status screen increases by 10.

In Time Lapse mode, you can capture a photo every 0.5 seconds.

### CAPTURING TIME LAPSE PHOTOS

To capture a Time Lapse series, verify that the camera is in **Time Lapse** mode. If the **Time Lapse** icon [  ] does not appear in the upper left on your camera status screen, press the **Power/Mode** button repeatedly until it appears.

#### To Capture Time Lapse Photos:

Press the **Shutter/Select** button. The camera status lights flash each time a photo is taken.

#### To Stop Time Lapse Photos:

Press the **Shutter/Select** button. The camera status lights flash three times and the camera emits three beeps.

---

**PRO TIP:** With QuikCapture, you can quickly turn your camera on and immediately begin capturing Time Lapse photos just by pressing and holding the **Shutter/Select** button for two seconds. To turn off QuikCapture, see [QuikCapture](#) (page 29).

In **Settings** mode [  ], you can change the video resolution and change settings that apply to all camera modes.

### NAVIGATING SETTINGS MENU

With your HERO, you can navigate the settings menus using the buttons on the camera.

#### To Navigate Settings Menus:

1. Press the **Power/Mode** button repeatedly to cycle to **Settings** mode [  ], then press the **Shutter/Select** button to select it.
2. Press the **Power/Mode** button repeatedly to cycle through the various settings.
3. Press the **Shutter/Select** button to open a setting.
4. Press the **Power/Mode** button repeatedly to cycle through the options for that setting.
5. Press the **Shutter/Select** button to select an option.
6. To exit, press the **Power/Mode** button to cycle to EXIT, and then press the **Shutter/Select** button.

---

**PRO TIP:** To exit from the Settings menu at any time, press and hold the **Shutter/Select** button for two seconds.

### RESOLUTION

The HERO includes the video capture resolutions listed below.

All video is captured at an Ultra Wide FOV, which provides the largest field of view and best image stability. Ultra Wide FOV is best when you want to include as much content as possible within the frame.

SuperView delivers the world's most immersive field of view. More vertical 4:3 content is automatically stretched to full-screen 16:9 for stunning widescreen playback on your computer or TV.

Video Resolution	FPS (NTSC/PAL)	FOV	Screen Resolution
1080p	30/25	Ultra Wide	1920x1080, 16:9
720p*	60/50	Ultra Wide	1280x720, 16:9
720p* SuperView	60/50	Ultra Wide	1280x720, 16:9

*\* All 720p resolutions include Auto Low Light. This feature automatically optimizes fps according to lighting conditions.*

### Video Setting

### Best Use

1080p

Highest resolution enhances clarity and detail to yield stunning results.

720p

Great for handheld shots of others and when slow motion is desired. Best for capturing fast-moving objects.

720p SuperView

Great for body- or gear-mounted shots, when you want to capture your own perspective, and when you want the maximum vertical FOV.



**PRO TIP:** Easily create epic GoPro-style videos using free GoPro software. Learn more and download this software at [gopro.com/getstarted](https://gopro.com/getstarted).

### SPOT METER

Spot Meter is good for filming into a setting where the lighting is different from where you are, such as filming the outdoors from within a car or a shaded environment while standing in the sun. Spot Meter automatically sets the exposure based on a single spot in the middle of the image. When Spot Meter is turned on, [  ] appears on the camera status screen. The options for this setting are Off (default) and On.

### UPSIDE DOWN

If you mount your camera upside down, you might have to rotate the files during editing. This setting eliminates the need to flip your video or photos after capture when the camera is mounted upside down. The default setting is Up.

Setting	Description
Up 	Camera is used right-side up.
Down 	Camera is used upside down.

### QUIKCAPTURE

With QuikCapture, you can quickly turn your camera on and begin capturing video or Time Lapse photos. The options for this setting are On (default) and Off.

#### To Use QuikCapture to Capture Video:

With the camera powered off, press and release the **Shutter/Select** button. Your camera automatically powers on and begins capturing video.

#### To Use QuikCapture to Capture Time Lapse Photos:

With the camera powered off, press and hold the **Shutter/Select** button for two seconds. Your camera automatically powers on and begins capturing Time Lapse photos.

#### To Stop Recording:

Press and release the **Shutter/Select** button to stop recording and power off the camera.

### NTSC/PAL

The Video Format settings govern frame rates for recording and playback when viewing video on a TV/HDTV.

Setting	Description
NTSC (default)	Viewing video on a NTSC TV/HDTV (most televisions in North America)
PAL	Viewing video on a PAL TV/HDTV (most televisions outside of North America)

### LED

This setting determines which camera status lights to activate. The options for this setting are Both On (front and rear), Both Off, Front On, and Rear On. The default setting is Both On.

### BEEPS

You can set the volume for the sound indicators to be 100% (default), 70%, or Off.

### DATE/TIME

Your camera's date and time are automatically set when you connect your camera to GoPro software. This setting lets you manually set the date and time, if needed.

### DELETE

This setting lets you delete the last file, or delete all files and format the memory card. LED lights blink until the operation is complete.

**NOTICE:** If you select All/Format, the memory card is reformatted, which deletes every video and photo file on your card.



## / Minimum System Requirements

---

For best results playing back your content on a computer, visit [gopro.com/getstarted](https://gopro.com/getstarted) to download the latest GoPro software. Be sure your Mac® or Windows® computer meets these minimum system requirements:

	Windows	Mac
Operating System	Windows 7, 8.x	OS X® 10.8 or later
CPU	Intel® Core 2 Duo™ (Intel Quad Core™ i7 or better recommended)	Intel Dual Core™ (Intel Quad Core i7 or better recommended)
Graphics Card	Card that supports OpenGL1.2 or later	
Screen Resolution	1280 x 800	1280 x 768
RAM	2GB (4GB or greater recommended)	4GB
Hard Drive	5400 RPM internal drive (7200 RPM drive or SSD recommended) If external, use USB 3.0 or eSATA	5400 RPM internal drive (7200 RPM drive or SSD recommended) If external, use Thunderbolt, FireWire or USB 3.0

## / Transferring and Playing Back Files

---

To play back your video and photos on a computer, you must first transfer these files to a computer.

### TO TRANSFER FILES TO A COMPUTER:

1. Download and install the latest GoPro software from [gopro.com/getstarted](https://gopro.com/getstarted). The HERO camera was designed to communicate with GoPro software to help you easily locate and transfer your files.
2. Connect the camera to your computer using the included USB cable.
3. Power on the camera.
4. Copy the files to your computer or external hard drive.
5. To play back the files, use GoPro software.

---

**PRO TIP:** You can also transfer files to a computer using a card reader (sold separately). Connect the card reader to your computer and insert the microSD card into the reader. You can then transfer your files to your computer or delete selected files on your card.

Your HERO camera, battery, and housing are integrated. You cannot remove the camera from the housing, or remove the battery from the camera.

The battery icon displayed in the camera status screen blinks when the battery drops below 10%. If the battery reaches 0% while recording, the camera saves the file and powers off.

### MAXIMIZING BATTERY LIFE

Extreme cold temperatures can decrease battery life. To maximize battery life in cold conditions, keep the camera in a warm place prior to use.

---

**PRO TIP:** QuikCapture helps maximize battery life. For details, see [QuikCapture](#) (page 29).

### CHARGING TIME

The battery charges to 80% in approximately one hour and 100% in approximately two hours when using a USB charging adapter. Some chargers might charge at a slower rate.

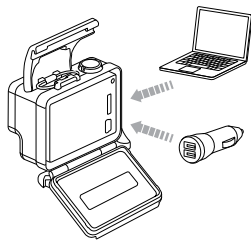

### USING THE CAMERA WHILE CHARGING

You can capture video and photos while charging the camera's battery. Plug the camera into a USB charging device using the included USB cable. Performance of non-GoPro chargers cannot be guaranteed. You cannot use your HERO while charging it through a computer.

**NOTICE:** Only use USB charging adapters marked 5V 1A. If you do not know the voltage and amperage of your charger, use the included USB cable to charge the camera from your computer.

### BATTERY STORAGE AND HANDLING

The camera contains sensitive components, including the battery. Avoid exposing your camera to very cold or very hot temperatures. Low or high temperature conditions may temporarily shorten the battery life or cause the camera to temporarily stop working properly. Avoid dramatic changes in temperature or humidity when using the camera, as condensation may form on or within the camera.

The integrated camera housing protects the camera and battery from water damage. For more information, see [Camera Housing](#) (page 39). Do not turn on your camera if the camera (inside the housing) gets wet. If your camera is already on, turn it off immediately. Allow the camera to dry thoroughly before using it again. Do not dry the camera or battery with an external heat source such as a microwave oven or hair dryer. Damage to the camera or battery caused by contact with liquid (inside the housing) is not covered under the warranty.



**WARNING: Do not drop, disassemble, open, crush, bend, deform, puncture, shred, microwave, incinerate, or paint the camera. Do not insert foreign objects into any opening on the camera, such as the mini-USB port. Do not use the camera if it has been damaged—for example, if cracked, punctured, or harmed by water. Disassembling or puncturing the integrated battery can cause an explosion or fire.**

---

### MICROSD CARD MESSAGES

NO SD	No card present. The camera requires a microSD, microSDHC or microSDXC card to capture videos and photos.
FORMAT SD?	Card is not formatted or is improperly formatted. Select Yes to format the card, or select No and insert a different card. <b>NOTICE:</b> If you select Yes, all of the content on the card is deleted.
FULL	Card is full. Delete files or swap card.
SD ERR	Camera is unable to read card formatting. Reformat the card in the camera.

**PRO TIP:** Reformat your microSD card on a regular basis to ensure that the card can continue to receive information from the camera.

### FILE REPAIR ICON

---



If you see the File Repair icon on the camera status screen, your last video file was corrupted during recording. Press any button to repair the file.

---

### TEMPERATURE ICON

---



The Temperature icon appears on the camera status screen when the camera becomes too hot and needs to cool down. Simply let it sit and cool before attempting to use it again. Your camera was designed to identify conditions of overheating and is designed to respond accordingly.

---

Your HERO camera comes with two types of backdoors: Standard Backdoor (waterproof) and Skeleton Backdoor (non-waterproof).

---

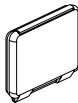

The Standard Backdoor makes the housing waterproof to 131' (40m). Use this door when you need to protect the camera from water, dirt, sand, and other environmental hazards.

---

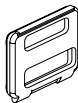

The Skeleton Backdoor (non-waterproof) provides better sound quality by allowing more sound to reach the camera's microphone. It also reduces wind noise at speeds up to 100mph when mounted on helmets, motorcycles, bikes, and other fast-moving vehicles. Use this backdoor only when sand, excessive dirt/dust, and water damage are not a risk. This backdoor is also recommended for use inside vehicles.

---

**PRO TIP:** Apply Rain-X® or a similar anti-beading solution to the camera housing lens to prevent water spots from forming when using your camera in rain or water.

### SWAPPING BACKDOORS

You can switch the backdoor of your HERO camera to suit your activity and shooting conditions.

*Note: Your HERO cannot be removed from the housing.*

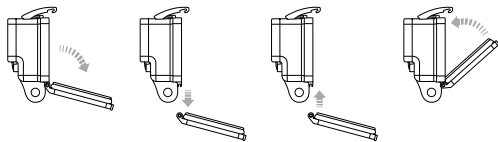

#### To Change the Backdoor:

1. Open the backdoor of the housing so that it hangs downwards.
2. Firmly pull the backdoor downwards until it snaps free from the main housing.
3. Line up the replacement backdoor into the hinge opening.
4. Push upwards on the backdoor until it clicks into place.

### PREVENTING WATER DAMAGE TO YOUR CAMERA

The rubber seal that lines the Standard Backdoor forms a waterproof barrier that protects your HERO in wet conditions.

Keep the Standard Backdoor's rubber seal clean. A single hair or grain of sand can cause a leak and damage your camera.

After every use in salt water, close the Standard Backdoor tightly, and then rinse the outside of the camera housing with non-salt water and dry. Not doing this can eventually cause corrosion of the hinge pin and salt buildup in the seal, which can cause failure.

To clean the seal, remove it from the backdoor, rinse it in fresh water, and shake dry (drying with a cloth may cause lint to compromise the seal). Re-install the seal into the grooves in the Standard Backdoor.



**WARNING: Failure to follow these steps each time you use your GoPro can result in leaks that may damage or destroy your camera. Water will damage both the camera and the battery, which could cause an explosion or fire. Your warranty does not cover water damage resulting from user error.**

### ATTACHING YOUR CAMERA TO MOUNTS

To attach your HERO camera to a mount, you need a Quick Release Buckle, thumb screw or hardware depending on the mount you are using. For more information on mounts, visit [gopro.com/support](https://gopro.com/support).

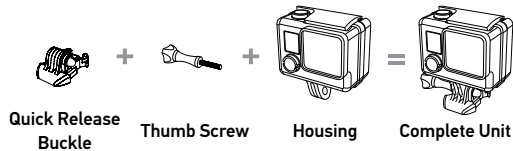

### USING CURVED + FLAT ADHESIVE MOUNTS

The Curved + Flat Adhesive Mounts make it easy to attach the camera to curved and flat surfaces of helmets, vehicles, and gear. Using the Quick Release Buckle, the assembled camera housing can be clicked on and off the secured Curved or Flat Adhesive Mounts.

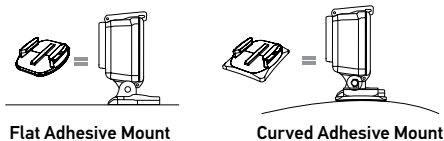

### MOUNTING GUIDELINES

Follow these guidelines when attaching mounts:

- Attach the adhesive mounts at least 24 hours before use. Allow 72 hours for complete adhesion.
- Adhesive mounts must be mounted only on smooth surfaces. Porous or textured surfaces do not enable a proper bond. When applying the mount, firmly press it into place and ensure full contact over the entire surface.
- Apply adhesive mounts to clean surfaces only. Wax, oil, dirt, or other debris reduce adhesion, which can result in a weak bond and risk of losing the camera should the connection fail.
- Attach adhesive mounts in room temperature conditions. Adhesives do not bond properly if applied in cold or damp environments to cold or damp surfaces.

For more information on mounts, visit [gopro.com/support](https://gopro.com/support).



**WARNING:** If using your camera with a GoPro helmet mount or strap, always select a helmet that meets the applicable safety standard. Choose the right helmet for your particular sport or activity and make sure that it is the right fit and size for you. Inspect your helmet to ensure that it is in good condition, and follow the helmet manufacturer's instructions on safe helmet use. Any helmet that has sustained a major impact should be replaced. No helmet can protect against injury in every accident.

### ATTACHING THE LOCKING PLUG

If you are using the HERO in high-impact sports such as surfing or skiing where significant impact might occur, use the locking plug to securely lock the Quick Release Buckle fingers into place. The locking plug helps to prevent the housing from accidentally releasing from the mount.

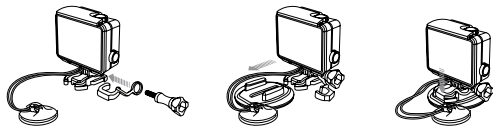

#### To Attach the Locking Plug:

1. Loop the circular ring over the thumbscrew. The circular ring acts as a leash to prevent dropping or losing the locking plug.
2. Slide the Quick Release Buckle into the mount until it clicks into place.
3. Press the U-shaped part of the plug into the U-shaped space in the Quick Release Buckle.



**WARNING:** To avoid injury in the event of an accident, do not use the locking plug or tether when using a mounting device on a helmet or other personal protective gear.

### MY GOPRO WON'T POWER ON

Make sure your GoPro is charged. To charge your camera, use the included USB cable and a computer or USB charging adapter.

### MY GOPRO WON'T RESPOND WHEN I PRESS A BUTTON

Press and hold the **Power/Mode** button for 8 seconds to reset your camera. This reset saves all of your content and settings, and powers off your camera.

### MY PLAYBACK IS CHOPPY

Choppy playback is typically not a problem with the file. If your footage skips, one of these situations is likely the cause:

- Using an incompatible video player. Not all video players support the H.264 codec. For best results, use the latest GoPro software, available for free at [gopro.com/getstarted](http://gopro.com/getstarted).
- The computer does not meet the minimum requirements for HD playback. The higher the resolution and frame rate of your video, the harder the computer has to work to play it back. Make sure that your computer meets the minimum requirements listed in [Minimum System Requirements](#) (page 32).
- Playing your content directly from your camera over a USB connection. Transfer the file to the computer to play back. If your computer does not meet the minimum requirements, make sure that all other programs on your computer are closed.

## / Customer Support

---

GoPro is dedicated to providing the best possible service. To reach GoPro Customer Support, visit **[gopro.com/support](https://gopro.com/support)**.

## / Trademarks

---

GoPro, HERO, the GoPro logo, the GoPro Be a Hero logo, BacPac, Protune, SuperView, and Wear It. Mount It. Love It. are trademarks or registered trademarks of GoPro, Inc. in the US and internationally. Other names and marks are the property of their respective owners.

## / Regulatory Information

---

To see additional information regarding country certifications, refer to the Important Product + Safety Information Guide included with your camera.

