

Unpacking guide of Tina2

ENTINA

TINA2

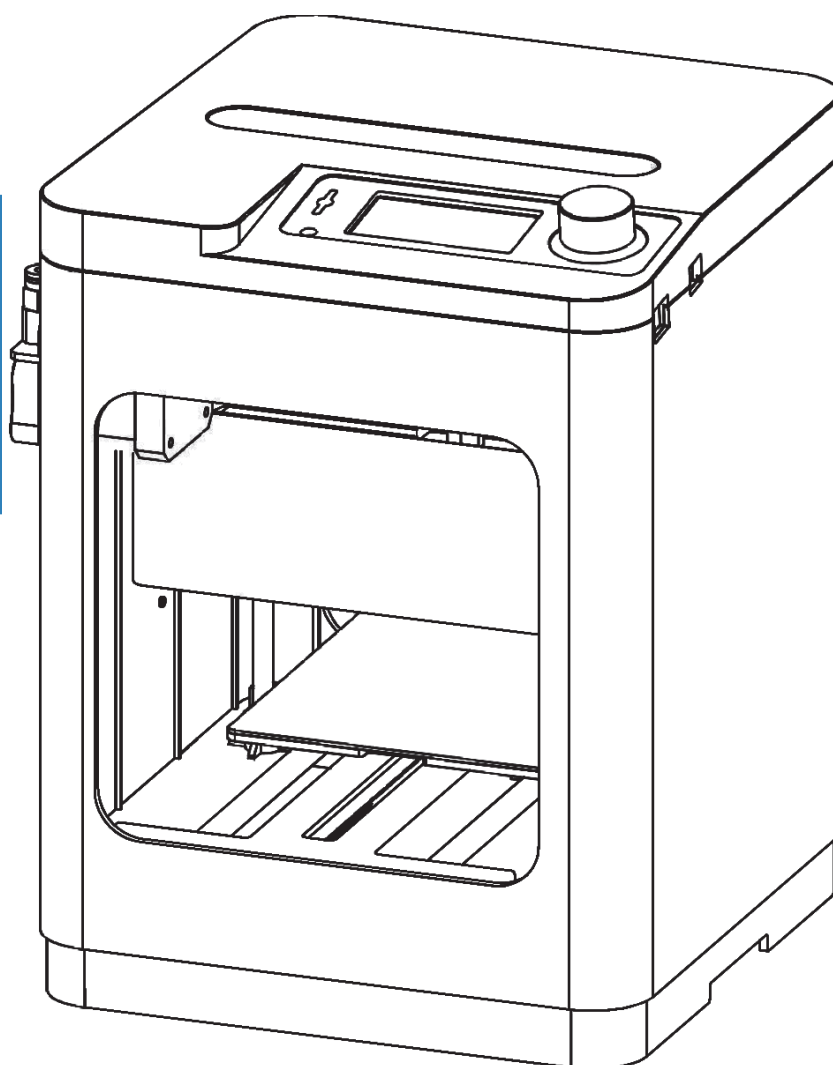

3D Printers are precision equipment, we have debugged various parameters and reinforced packaging. Uncertainty in logistics and transportation may cause machine parameter misalignment or hardware damage. Please test the printer after opening box. If you have any problem, please contact us! Our email address is: support@entina3d.com, we will give you the most professional guidance. You can go to our wiki website for more information. <http://www.entina3d.com>

Step 1: Open the package of Tina2



Open your Accessory box list:



Two pieces of sticker /1.5mm hex wrench /2.0mm hex wrench/ 2.5mm hex wrench/ Wrench / M6 Nozzle /TF Card/TF Card Reader/ Power adaptor/ Power cable/ Filament

Step2: Prepare for printing

Take out the printer, then take off the fixed block, Put the feed tube into connector.

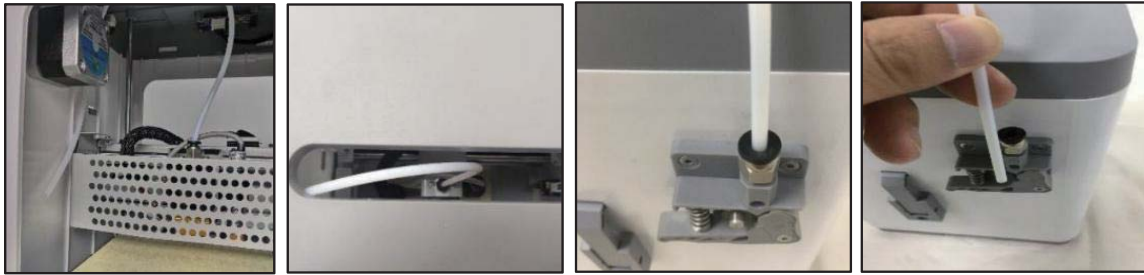

Step3: Start Printing

Connect the power cable and power adaptor together and then prepare for power-on.

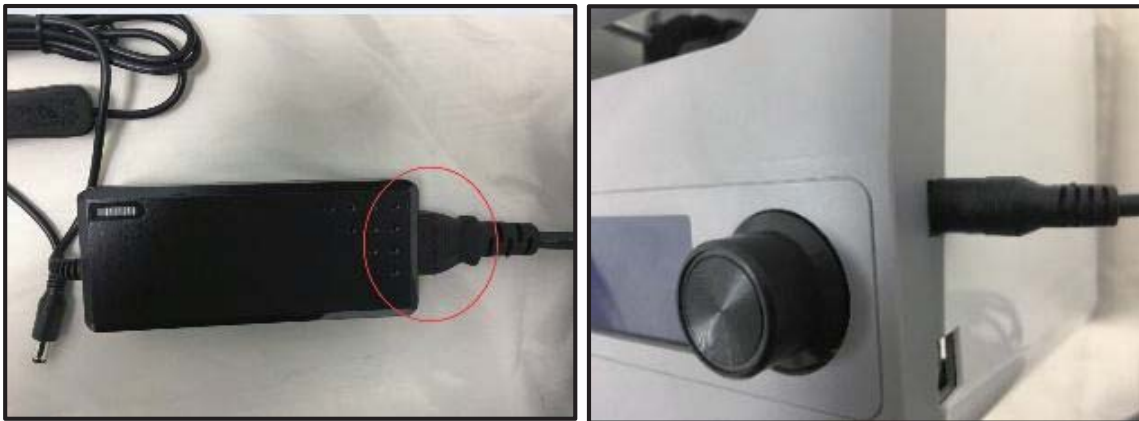

When you boot the machine, there is a wizard interface, just do with these steps

1: Load Filament

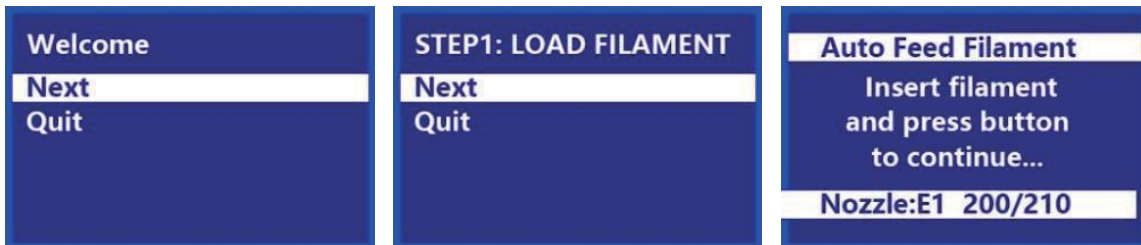

Make the filament get into feed tube. **The beginning part of filament should cut, and make the filament straightly get into feed tube.**



Press the Knob to start loading filament. Once filament starts extruding from the Nozzle, press the Knob again to stop extrusion. Clean the extruded filament, then press the Knob to select the Continue option.

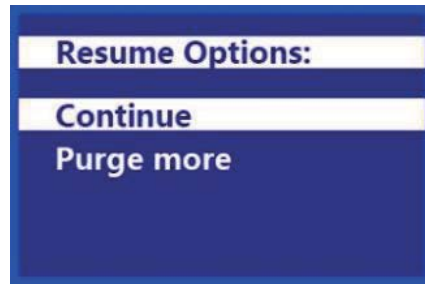
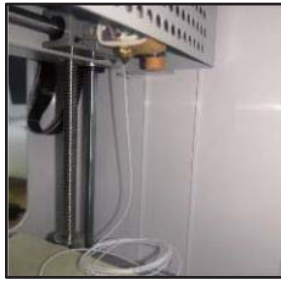

2: Insert SD Card

In this step you do not need to shut down the machine, you need pay attention to the Insert direction of the card, text surface in the left

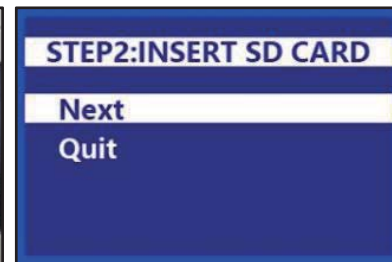

3: Print from SD, choose the G-code file in the SD Card.

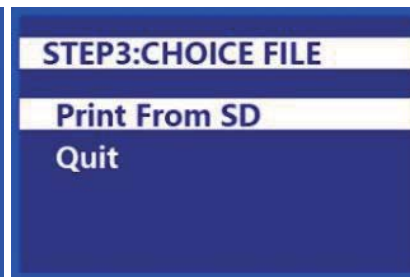

4. Once the print is finished, remove the Magnetic Print Bed from the metal print platform, then bend it to remove the model. Replace the Magnetic Print Bed on the metal print platform.



After all this you have printed your first works, to know more about the machine function and usage, please read the Instruction manual in the SD card.

Schritt 1: Nehmen Sie Drucker und Zubehör aus der Verpackung.



Öffnen Sie Ihre Zubehörbox-Liste::



2x Aufkleber, 1x 1.5 mm Sechskantschlüssel, 1x 2.0 mm Sechskantschlüssel, 1x 2.5 mm Sechskantschlüssel, 1x Phillips Schraubendreher, 1x 8 mm Schraubenschlüssel, 1x M6 Messingdüse, 1x MicroSD™ -Karte, 1x MicroSD-Kartenleser, 1x Wechselstrom-Netzadapter, 1x Wechselstrom-Netzkabel, 1x Packung Filament zur Probe, 1x Schnellanleitung

Schritt 2: Bereiten Sie den Druck vor

Stecken Sie das Filament-Führungsrohr in den schwarzen pneumatischen Anschluss oben auf dem Extruder..

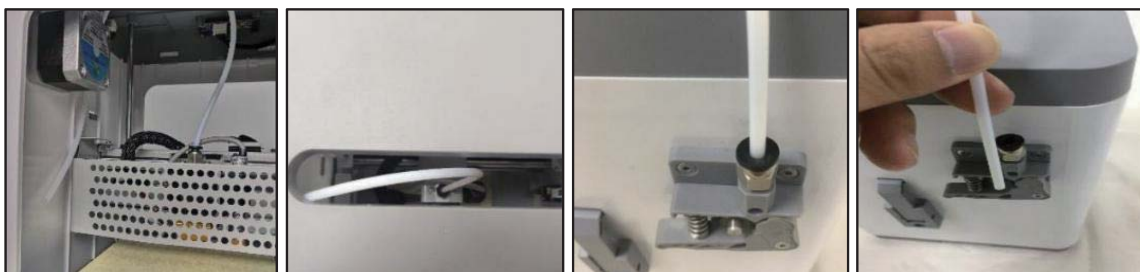

Schritt 3: Drucken starten

Verbinden Sie das Netzkabel und das Netzteil miteinander und bereiten Sie dann das Einschalten vor.

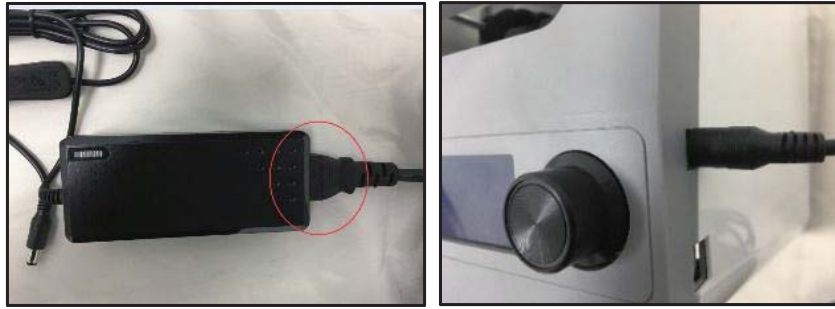

Wenn Sie den Drucker starten, gibt es eine Assistentenoberfläche, führen Sie einfach diese Schritte aus

1: FILAMENT LADEN

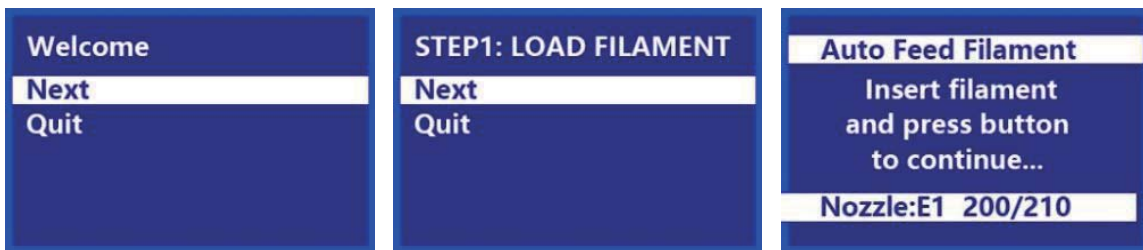

Schneiden Sie mit einer Schere oder einem Seitenschneider am Ende des Filaments ungefähr 2,5 cm ab und begradigen Sie anschließend vorsichtig das Ende des Filaments. Drücken Sie den Hebel am Extruder zu, führen Sie das Filament an der Unterseite ein bis Sie auf Widerstand stoßen, und lassen Sie den Hebel anschließend wieder los.

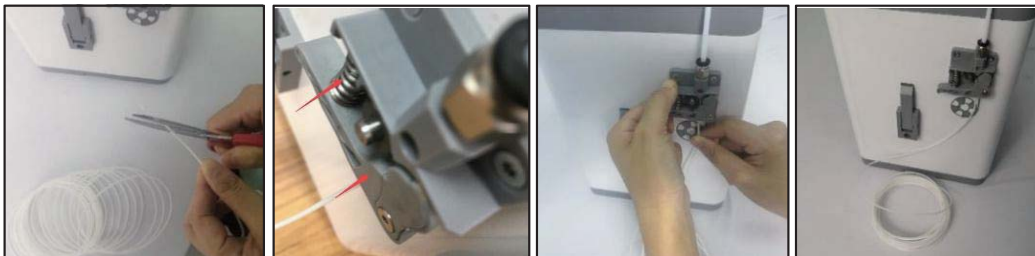

Drücken Sie den Drehknopf, um mit dem Laden des Filaments zu beginnen. Sobald die Düse beginnt Filament zu extrudieren, drücken Sie den Drehknopf erneut um die Extrusion zu stoppen, drücken Sie anschließend den Drehknopf, um die Option Fortfahren auszuwählen

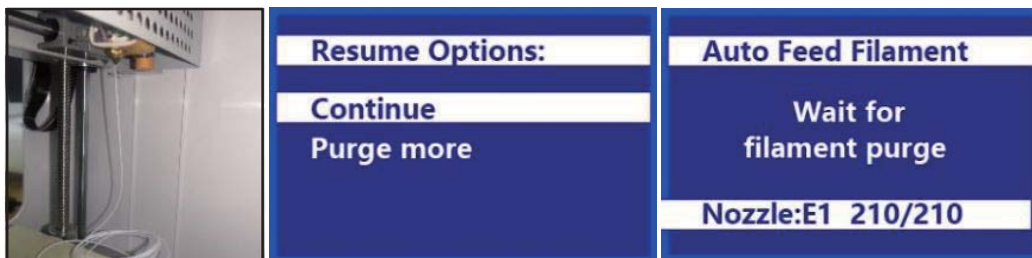

2: microSD™-Karte einlegen

Entnehmen Sie die mitgelieferte microSD™-Karte der Zubehörkiste und stecken Sie sie in den microSD-Kartensteckplatz links des LCD- - Bildschirms. Drücken Sie den Drehknopf, um auf dem Assistenten Weiter auszuwählen.

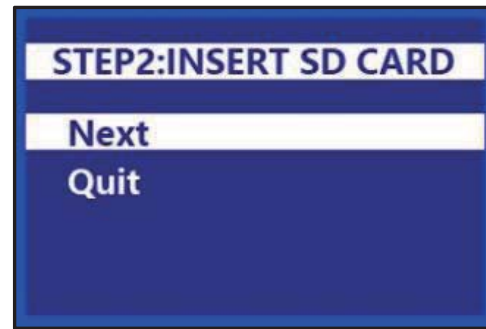

3: Drücken Sie den Drehknopf, um Von SD drucken auszuwählen. Drehen Sie den Drehknopf, um eine Datei mit dem Format .gcode auf der microSD-Karte auszuwählen, und drücken Sie dann den Drehknopf, um den Druckvorgang für das ausgewählte Modell zu beginnen.

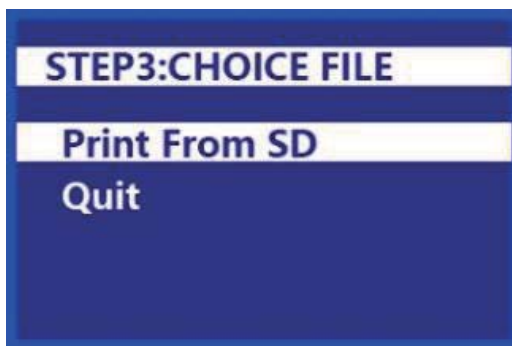

4: Sobald der Druckvorgang abgeschlossen ist, entnehmen Sie das magnetische Druckbett der metallischen Druckplattform und biegen Sie es, um das Modell von ihr abzulösen. Ersetzen Sie das magnetische Druckbett auf der metallischen Druckplattform.

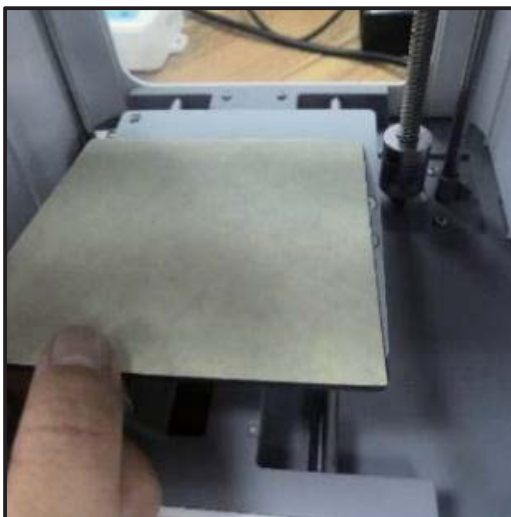

Nach all dem haben Sie Ihre ersten Werke gedruckt, um mehr über die Maschinenfunktion und Bedienung zu erfahren, lesen Sie bitte die Bedienungsanleitung auf der SD-Karte.

Étape 1 : Ouvrez le paquet de Tina2



Ouvrez votre liste de boîtes d'accessoires :



2x autocollants, 1x clé hexagonale de 1.5 mm, 1x clé hexagonale de 2.0 mm, 1x clé hexagonale de 2.5 mm, 1x tournevis cruciforme, 1x clé de 8 mm, 1x buse en laiton M6, 1x carte MicroSD™, 1x lecteur de carte MicroSD, 1x adaptateur d'alimentation CA, 1x cordon d'alimentation CA, 1x paquet d'échantillons de filaments, 1x guide de démarrage rapide

Étape 2 : préparer l'impression

Insérez le tube de guidage du filament dans le connecteur pneumatique noir situé sur le dessus de l'extrudeuse .

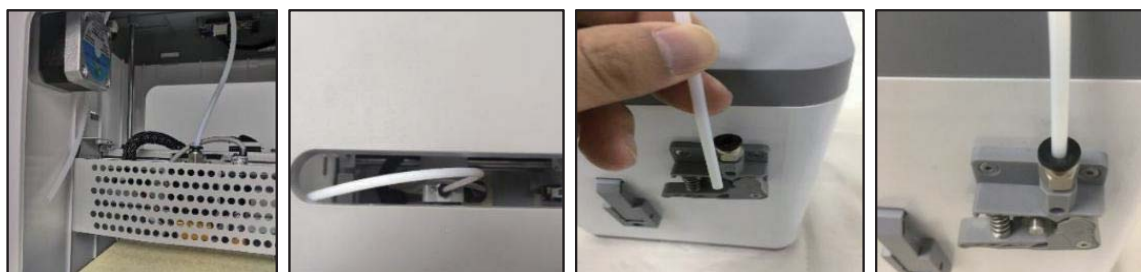

Étape 3 : Commencez l'impression

Connectez le câble d'alimentation et l'adaptateur d'alimentation ensemble, puis préparez-vous à la mise sous tension.



Lorsque vous démarrez la machine, il y a une interface d'assistant, il suffit de suivre ces étapes

1: CHARGEMENT DES FILAMENTS

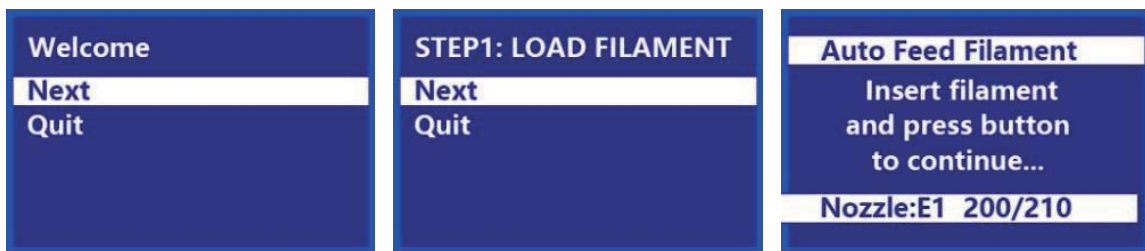

À l'aide d'une paire de ciseaux ou de pinces coupantes, coupez l'extrémité du filament d'environ un pouce, puis redressez doucement l'extrémité du filament. Serrez le levier de l'extrudeuse, insérez le filament dans le fond jusqu'à ce que vous rencontriez une résistance, puis relâchez le levier.



Appuyez sur le bouton pour commencer à charger le filament. Une fois que le filament commence à sortir de la buse, appuyez à nouveau sur le bouton pour arrêter l'extrusion, puis appuyez sur le bouton pour sélectionner l'option Continuer.

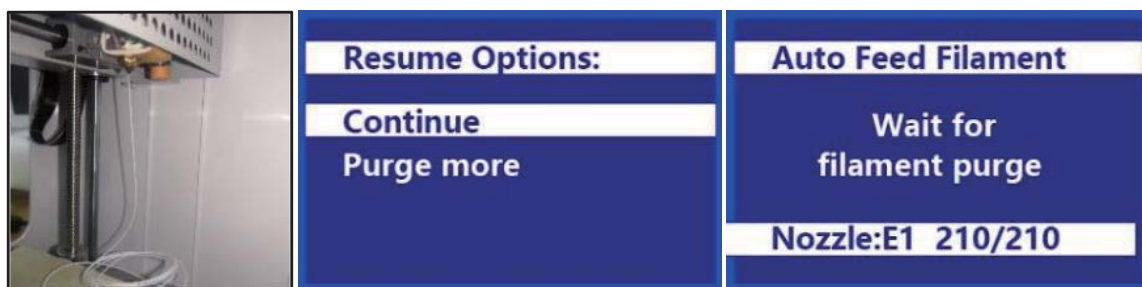

2: Insérer la carte SD

Retirez la carte microSD™ incluse dans la boîte à accessoires, puis insérez-la dans la fente pour carte microSD à gauche de l'écran LCD. Appuyez sur le bouton pour sélectionner Suivant dans l'assistant.



3: Appuyez sur le bouton pour sélectionner Imprimer à partir de SD. Tournez le bouton pour mettre en surbrillance un fichier .gcode sur la carte microSD, puis appuyez sur le bouton pour commencer à imprimer le modèle en surbrillance.

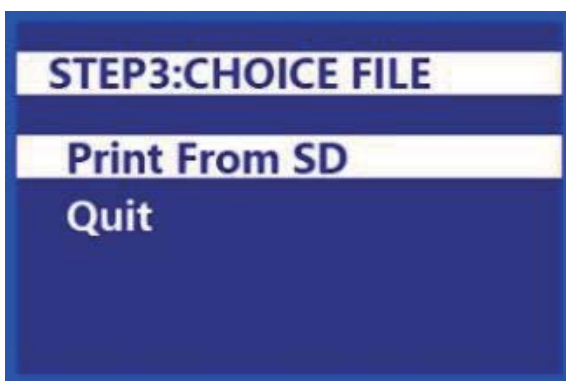

4. Une fois l'impression terminée, retirez le plateau d'impression magnétique de la plate-forme d'impression métallique, puis pliez-le pour retirer le modèle. Remplacez le plateau d'impression magnétique sur la plate-forme d'impression en métal.

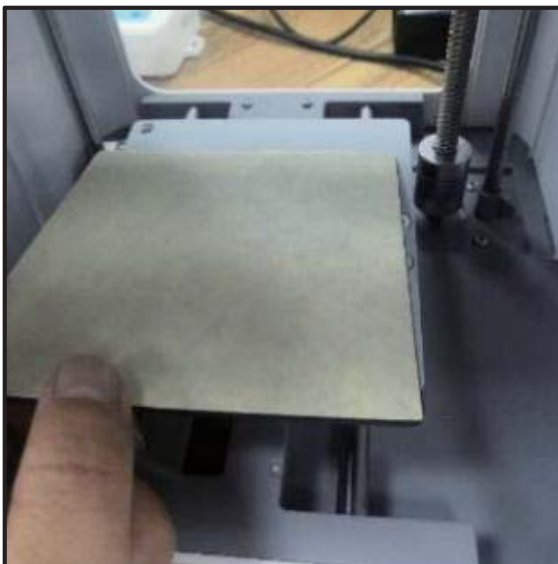

Après tout cela, vous avez imprimé vos premiers travaux, pour en savoir plus sur le fonctionnement et l'utilisation de la machine, veuillez lire le manuel d'instructions dans la carte SD.

Paso 1: abre el paquete de Tina2



Abra la lista de su caja de accesorios:



2x pegatinas, 1x llave hexagonal de 1.5 mm, 1x llave hexagonal de 2.0 mm, 1x llave hexagonal de 2.5 mm, 1x destornillador Phillips, 1x llave de 8 mm, 1x boquilla de latón M6, 1x tarjeta MicroSD™, 1x lector de tarjetas MicroSD, 1x adaptador de corriente alterna, 1x cable de alimentación, 1x paquete de filamentos de muestra, 1x guía de inicio rápido

Paso 2: prepárese para imprimir

Inserte el tubo guía para el filamento dentro del conector neumático negro situado en la parte superior de la extrusora

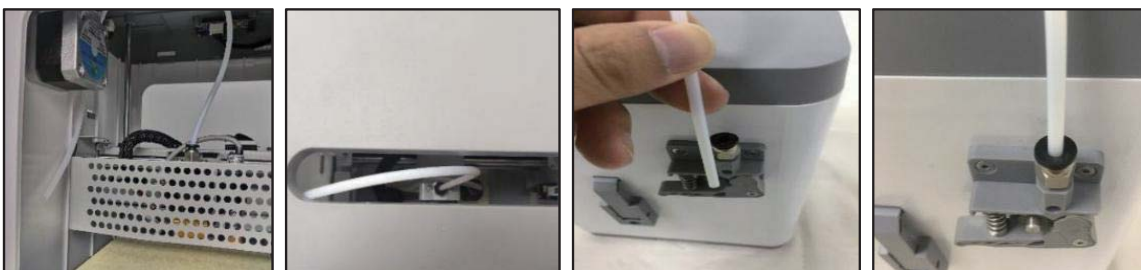

Paso 3: comience a imprimir

Conecte el cable de alimentación y el adaptador de alimentación juntos y luego prepárese para el encendido.

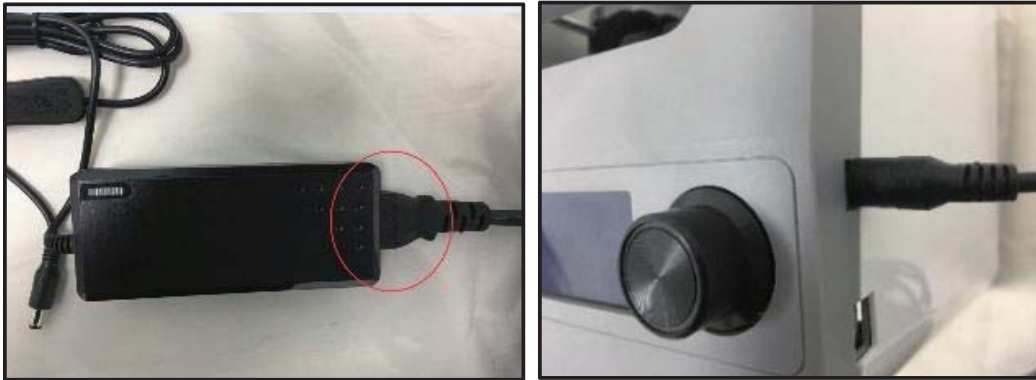

Cuando arranca la máquina, hay una interfaz de asistente, solo siga estos pasos

1: CARGAR FILAMENTO

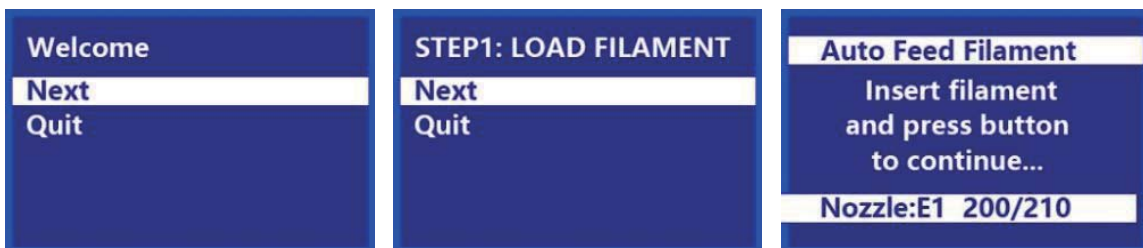

Con unas tijeras o unos alicates de punta larga, corte aproximadamente una pulgada del extremo del filamento y después enderece suavemente el extremo del filamento restante. Apriete la palanca de la extrusora, inserte el filamento en la parte inferior hasta que encuentre resistencia, luego suelte la palanca.

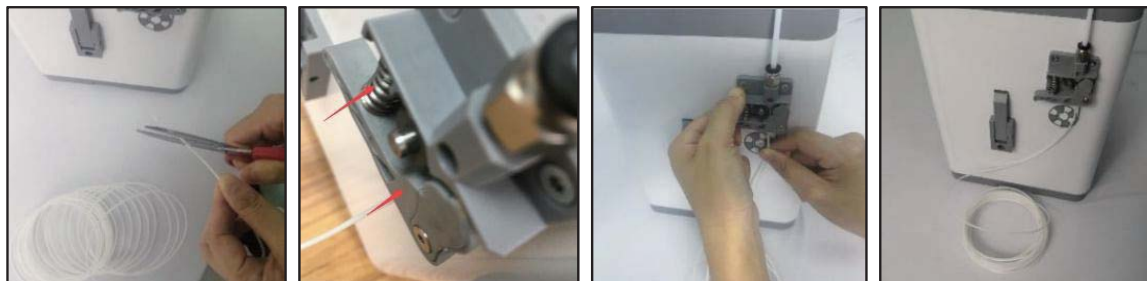

Presione la perilla para comenzar a cargar el filamento. Una vez que el filamento empiece a extrudirse por la boquilla, pulse de nuevo la perilla para detener la extrusión, luego pulse la perilla para seleccionar la opción Continuar.

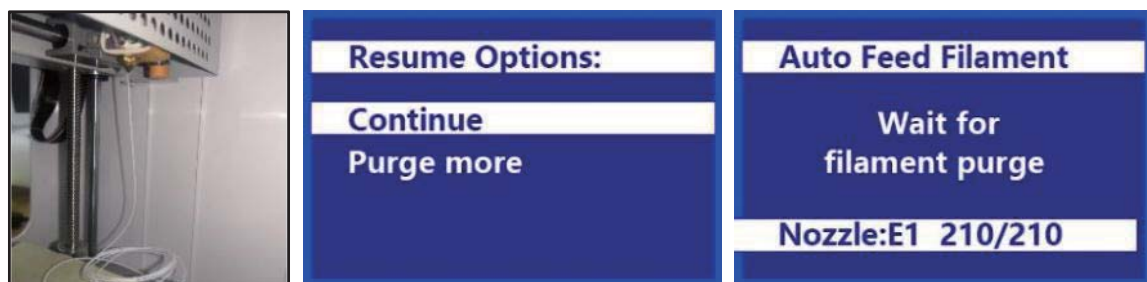

2: Insertar tarjeta SD

Retire la tarjeta microSD™ incluida en la caja de accesorios y luego insértela en la ranura para tarjetas microSD a la izquierda de la pantalla LCD. Pulse la perilla para seleccionar Siguiente en el asistente



3: Pulse la perilla para seleccionar Imprimir desde SD. Gire la perilla para resaltar un archivo .gcode en la tarjeta microSD y luego pulse la perilla para comenzar a imprimir el modelo resaltado

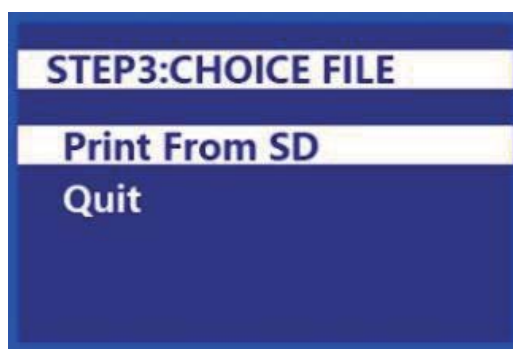

4. Una vez finalizada la impresión, retire la base de impresión magnética de la plataforma de impresión metálica y dóblela para retirar el modelo. Coloque nuevamente la base de impresión magnética en la plataforma de impresión metálica



After all this you have printed your first works, to know more about the machine function and usage, please read the Instruction manual in the SD card.

Después de todo esto, ha impreso sus primeros trabajos, para saber más sobre el funcionamiento y el uso de la máquina, lea el manual de instrucciones en la tarjeta SD.

Passaggio 1: aprire il pacchetto di Tina2

Apri l'elenco della casella degli accessori:



2x Adesivo per piattaforma, 1x Chiave a Brugola da 1.5mm, 1x Chiave a Brugola da 2.0mm, 1x Chiave a Brugola da 2.5mm, 1x Cacciavite a croce, 1x Ugello in Ottone M6, 1x Chiave Inglese da 8mm, 1x Adattatore Esterno AC, 1x Cavo di alimentazione, 1x Scheda microSD™, 1x Lettore di Schede microSD™, 1x Confezione di filamento, 1x Guida Rapida

Passaggio 2: prepararsi per la stampa

Inserire il tubo di guida del filamento nel connettore pneumatico nero in cima all'estrusore.

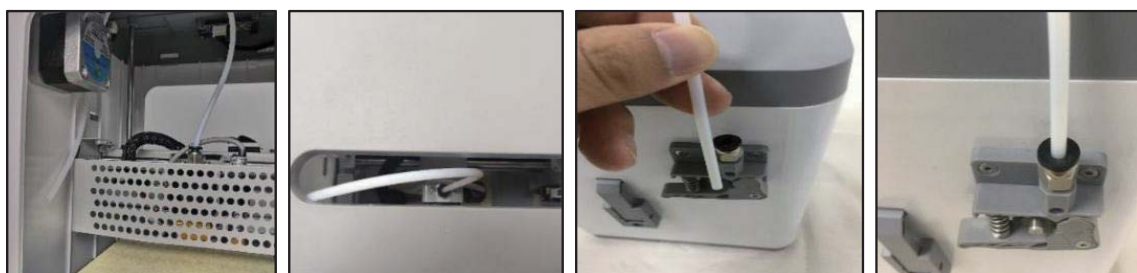
**Passaggio 3: iniziare a stampare**

Collegare insieme il cavo di alimentazione e l'adattatore di alimentazione, quindi prepararsi per l'accensione.

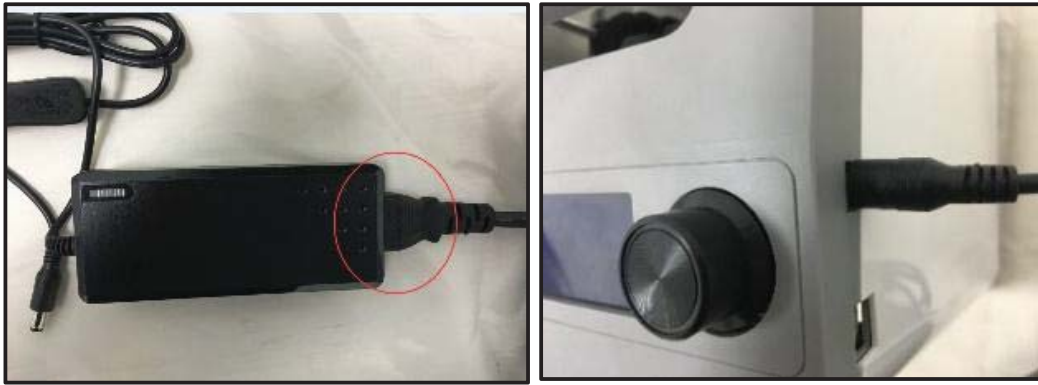

Quando si avvia la macchina, c'è un'interfaccia guidata, basta fare con questi passaggi
1: Caricare il filamento

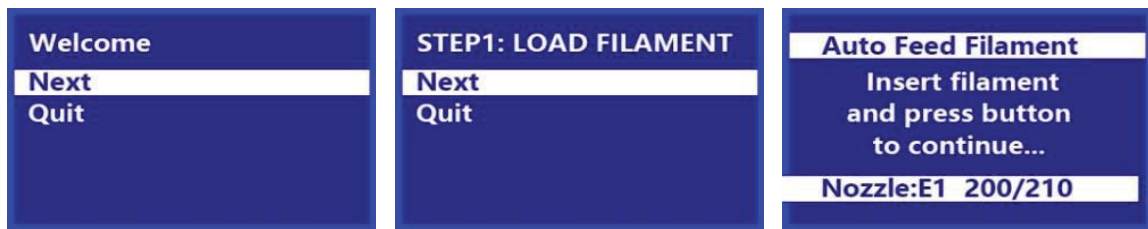

Utilizzando un paio di forbici o una tronchese, tagliare circa due centimetri e mezzo dall'estremità del filamento, quindi delicatamente raddrizzarne l'estremità. Stringere la leva sull'e e str usore, inserire il filamento a fondo, fino a percepire una resistenza; quindi rilasciare la leva.

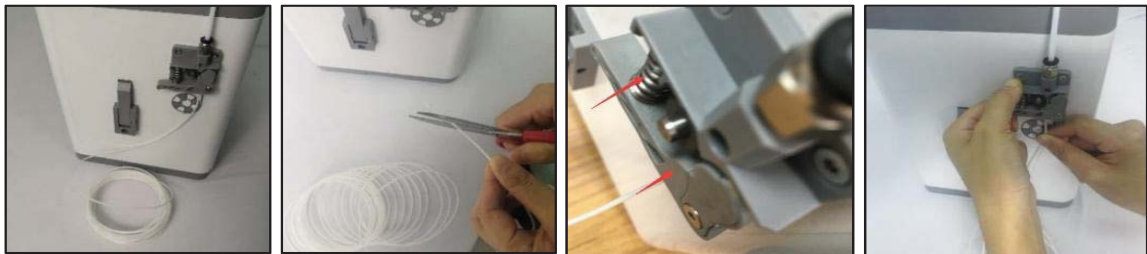

Premere la manopola per iniziare a caricare il filamento. Una volta che il filamento inizia a estrudere dall'u u gello, premere di nuovo la m anopola per arrestare l'estrusione; quindi premere la m anopola per selezionare l'opzione Continue



2: inserire la scheda SD

Estrarre la scheda microSD™ dalla scatola degli accessori e inserirla nell'apposito slot sulla sinistra dello Schermo LCD. Premere la m anopola per selezionare Ne xt nella procedura guidata

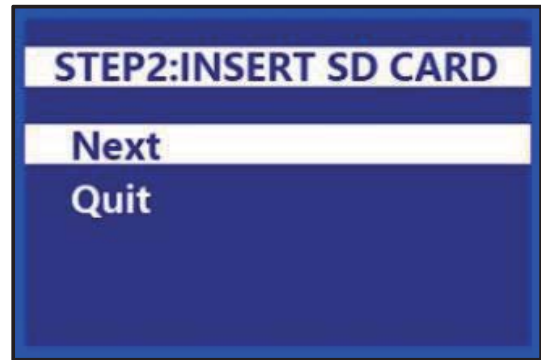
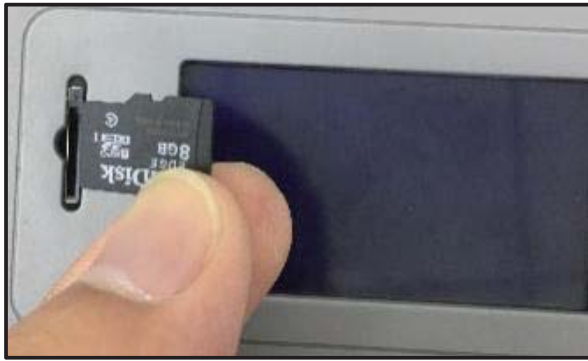

3: Premere la manopola per selezionare Print From SD. Ruotare la manopola per evidenziare un file .gcode sulla scheda microSD, quindi premere la manopola per iniziare a stampare il modello evidenziato

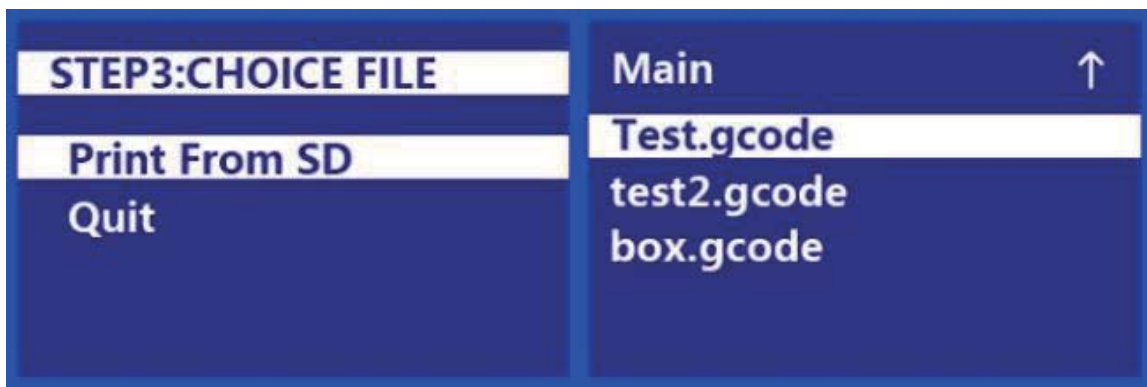

4: Una volta terminata la stampa, rimuovere il piano di stampa magnetico dalla piattaforma metallica di stampa, quindi piegarlo per rimuovere il modello. Sostituire il piano di stampa magnetico sulla piattaforma metallica di stampa.

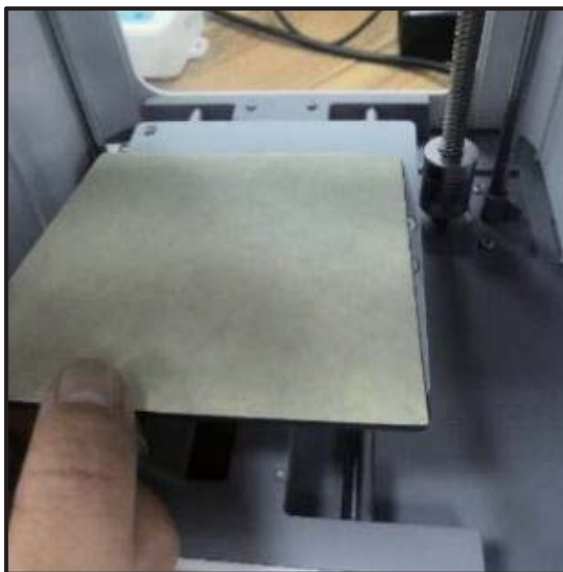

Dopo aver stampato i tuoi primi lavori, per saperne di più sul funzionamento e l'utilizzo della macchina, leggi il manuale di istruzioni nella scheda SD.