

# ENTINA

## 3D Printer TINA2

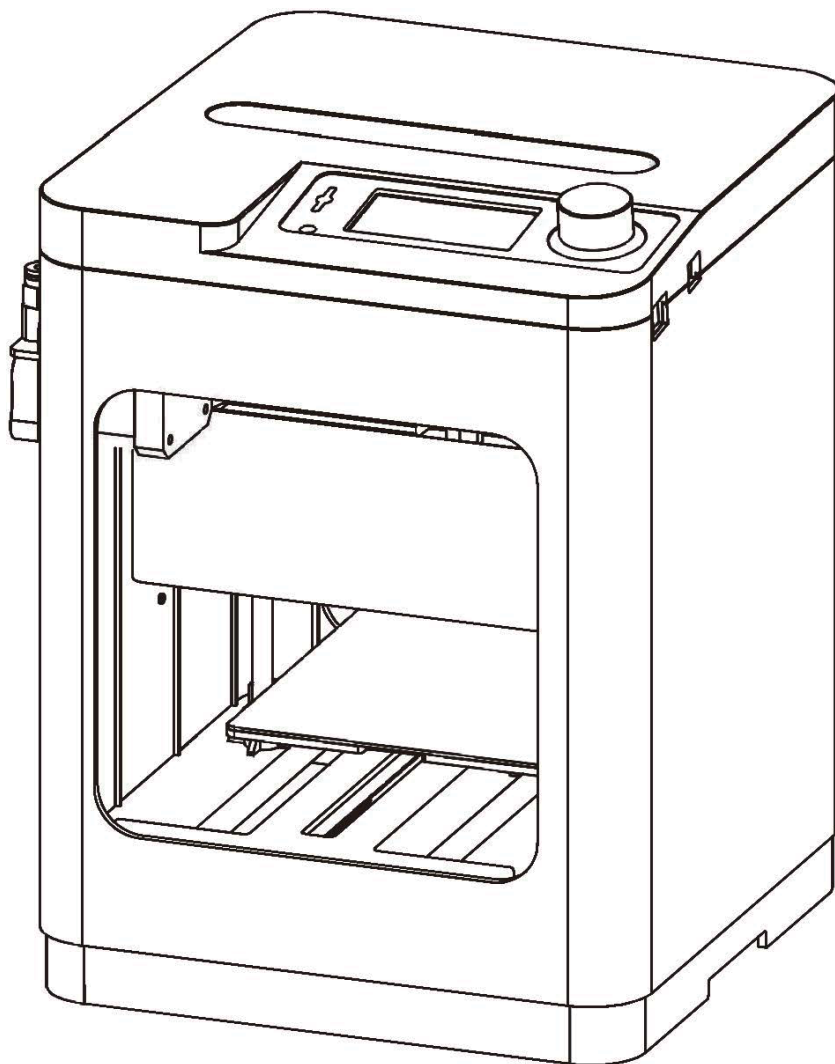

## User's Manual



# CONTENTS

SAFETY WARNINGS AND GUIDELINES.....	4
CUSTOMER SERVICE.....	5
PACKAGE CONTENTS.....	6
PRODUCT OVERVIEW.....	6
GETTING STARTED.....	7
OSD MENU MAP.....	10
BASIC MENU CONTROL.....	11
OSD MENU SYSTEM.....	11
Welcome/Info Screen.....	11
Main Menu.....	11
Prepare Menu.....	11
Control Menu.....	12
Wi-Fi Network Menu.....	12
Move Axis Menu.....	13
Move X/Y/Z/Extruder Menu.....	13
Print Control Menu.....	13
Tune Menu.....	14
Power Loss Recovery Menu.....	15
COMMON MENU OPERATIONS.....	15
Print from SD.....	15
Loading Filament.....	16
Unloading Filament.....	17
Changing Filament.....	17
Auto Home.....	17
Move Axis.....	18
Level Bed.....	19

Disable Steppers.....	19
Adjusting Target Temperature.....	20
Z Offset Setting.....	20
Connect to Wi-Fi®.....	21
Show Wi-Fi® IP.....	24
Wi-Fi Device/Machine Info.....	25
Firmware Update.....	25
Changing Parameters While Printing.....	26
Pausing and Resuming Print.....	26
Changing Filament While Printing.....	27
Saving a Print.....	28
Continuing a Print After Power Loss.....	29
Canceling a Print in Progress.....	29
Printing with the App.....	30
WIIBUILDER SLICING SOFTWARE.....	31
Installation.....	31
TECHNICAL SUPPORT.....	35
SPECIFICATIONS.....	36
REGULATORY COMPLIANCE.....	37
Notice for FCC.....	37
Radio Notice for FCC.....	38
RF Exposure Statement for FCC.....	38



## SAFETY WARNINGS AND GUIDELINES

Please read this entire manual before using this device, paying extra attention to these safety warnings and guidelines. Please keep this manual in a safe place for future reference.

- This device is intended for indoor use only.
- Do not expose this device to water or moisture of any kind. Do not place drinks or other containers with moisture on or near the device. If moisture does get in or on the device, immediately unplug it from the power outlet and allow it to fully dry before reapplying power.
- Do not touch the device, the power cord, or any other connected cables with wet hands.
- Do not expose this device to excessively high temperatures. Do not place it in, on, or near a heat source, such as a fireplace, stove, radiator, etc. Do not leave it in direct sunlight.
- Use only in a well-ventilated area. Do not use in close, confined spaces.
- Prior to operation, check the unit and power cord for physical damage. Do not use if physical damage has occurred.
- Before plugging the unit into a power outlet, ensure that the outlet provides the same type and level of power required by the device.
- Unplug this device from the power source when not in use.
- Take care to prevent damage to the power cord. Do not allow it to become crimped, pinched, walked on, or become tangled with other cords. Ensure that the power cord does not present a tripping hazard.
- Never unplug the unit by pulling on the power cord. Always grasp the connector head or adapter body.
- Clean using a soft, dry cloth only. Do not use chemical cleaners, solvents, or detergents. For stubborn deposits, moisten the cloth with warm water.
- This device has no user serviceable parts. Do not attempt to open, service, or modify this device.

- Take care to avoid touching hot parts, including heat blocks, extruder nozzle, and extruded filament.
- Do not wear gloves when operating or repairing to avoid entanglement.
- Keep the printer and all accessories out of reach of children.
- Do not reach inside the printer during operation.
- Always allow the printer and extruded filament to cool before reaching inside.
- Ensure that the printer is turned off and unplugged from its power source before making repairs or performing service.
- Do not install this printer on an unstable surface where it could fall and cause either personal injury or damage to the device and/or other equipment.
- Do not subject the printer to extreme force, shock, or fluctuations in temperature or humidity.

## CUSTOMER SERVICE

The Customer Service department is dedicated to ensuring that your ordering, purchasing, and delivery experience is second to none. If you have any problem with your order, please give us an opportunity to make it right. You can contact our Customer Service representative through the Live Chat link on our website [www.entina3d.com](http://www.entina3d.com) or via email at [support@entina3d.com](mailto:support@entina3d.com). Check the website for support times and links.

## PACKAGE CONTENTS

Please take an inventory of the package contents to ensure you have all the items listed below. If anything is missing or damaged, please contact Customer Service for a replacement.

1x 3D Printer	1x Stick of Glue
1x Package of Filament	1x 1.5mm Hex Wrench
1x AC Power Adapter	1x 2.0mm Hex Wrench
1x AC Power Cord	1x 2.5mm Hex Wrench
1x USB Cable <sup>1</sup>	1x Phillips Screwdriver
1x microSD™Card	1x M6 Brass Nozzle
1x microSD Card Reader	1x 8mm Wrench
2x Platform Sticker	1x Quick Start Guide

*1\* The TINA2 Basic printer version did not has the USB cable and 200g Filament.*

## PRODUCT OVERVIEW



## GETTING STARTED

1. Remove the printer and Accessory Box from the packaging. Remove the foam and plastic from the printer and place it on a table or desk.

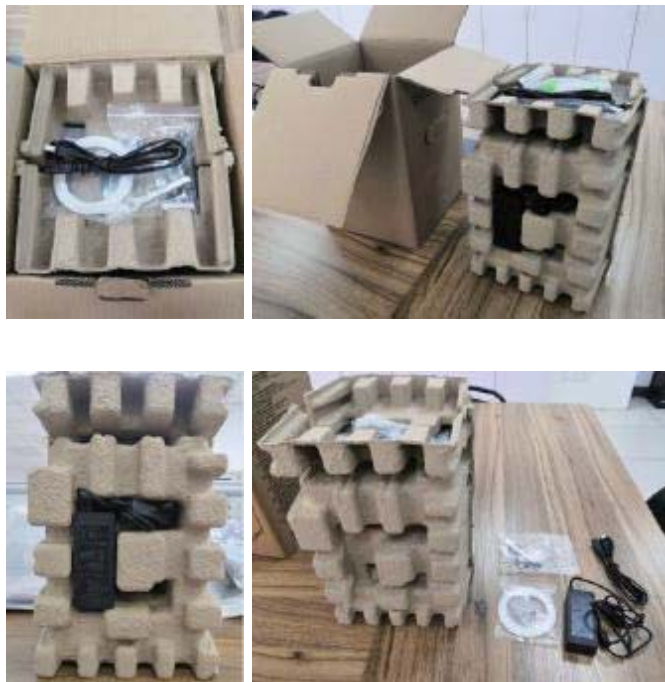

2. Open the Accessory Box and verify that you have all the parts listed below:

2x Stickers, 1x 1.5mm Hex Wrench, 1x 2.0mm Hex Wrench

1x 2.5mm Hex Wrench, 1x Phillips Screwdriver, 1x 8mm Wrench 1x

M6 Brass Nozzle, 1x MicroSD™ Card, 1x MicroSD Card Reader 1x

USB Cable, 1x AC Power Adapter, 1x AC Power Cord

1x Stick of Glue, 1x Package Sample Filament, 1x Quick Start Guide



*The accessories list may be different due to your TINA2 Version.*

3. Remove the eggshell carton and plastic bag from the printer, then place the printer on a table or desk.



4. Remove the cardboard block from the inside of the printer.





5. Insert the Filament Guide Tube into the black pneumatic connector on top of the Extruder.



6. Ensure that the power switch on the inline control on the AC Power Adapter is in the OFF position (O). Plug the DC barrel connector on the AC Power Adapter into the Power Port on the right side of the printer. Plug the included AC Power Cord into the AC Power Adapter, then plug the other end into a nearby AC power outlet.



7. Flip the power switch on the inline control to the ON position (I). After the printer finishes booting, you will see the following wizard. Depress the Knob on top of the printer to select Next on the Welcome Screen, then again to select Next on the STEP 1: LOAD FILAMENT Screen.



8. Using a pair of scissors or side cutters, cut about an inch off the end of the filament, then gently straighten the end of the filament. Squeeze the lever on the Extruder, insert the filament into the bottom until you encounter resistance, then release the lever.
9. Press the Knob to start loading filament. Once filament starts extruding from the Nozzle,

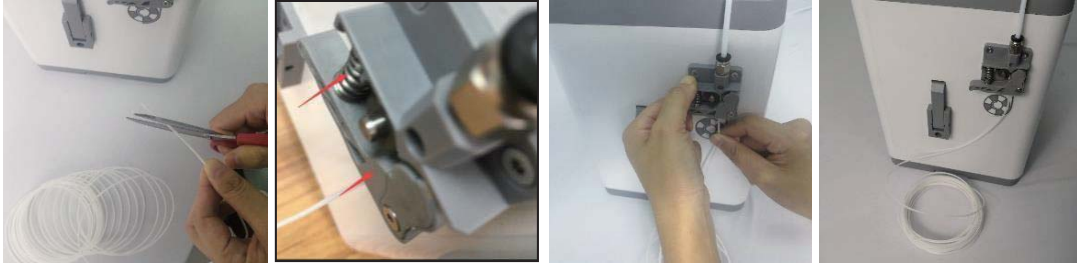

press the Knob again to stop extrusion, then press the Knob to select the Continue option.



10. Remove the included microSD™ card from the Accessory Box, then insert it into the microSD card slot to the left of the LCD Screen. Press the Knob to select Next on the wizard.



11. Press the Knob to select Print From SD. Rotate the Knob to highlight a .gcode file on the microSD card, then press the Knob to begin printing the highlighted model.



- Once the print is finished, remove the Magnetic Print Bed from the metal print platform, then bend it to remove the model. Replace the Magnetic Print Bed on the metal print platform.



## OSD MENU MAP

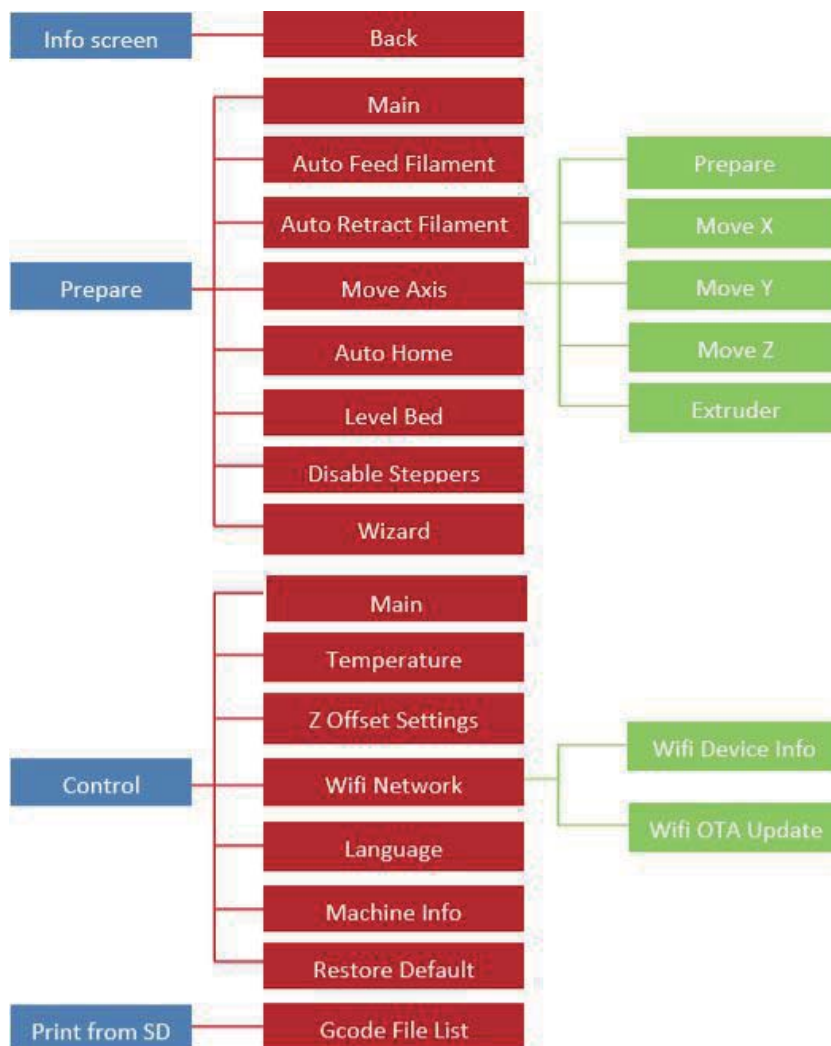



## BASIC MENU CONTROL

- Rotate the Knob clockwise to move the highlight down on the menus or to decrease a value.
- Rotate the Knob counterclockwise to move the highlight up on the menus or to increase a value.
- Press the Knob to enter the highlighted menu, select the highlighted option, or accept the edited value.

## OSD MENU SYSTEM

### Welcome/Info Screen

- After the Tina 2 starts up, the Welcome/Info Screen is displayed. Press the Knob to continue to the Main Menu.

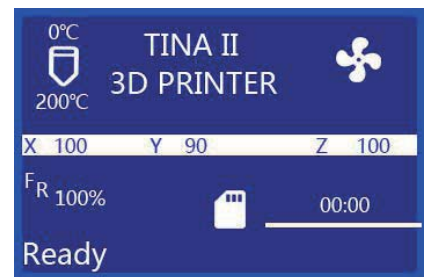

### Main Menu

- Info Screen: Displays the Welcome/Info Screen.
- Prepare: Displays the Prepare Menu.
- Control: Displays the Control Menu.
- Print From SD: Displays the File Selection Screen.

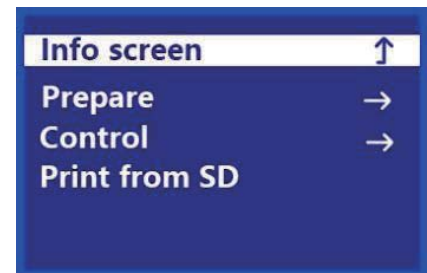

### Prepare Menu

- Main: Returns to the Main Menu.
- Auto Feed Filament: Starts the Loading Filament process.
- Auto Retract Filament: Starts the Unloading Filament process.
- Move Axis: Displays the Move Axis Menu.



- Auto Home: Moves the Extruder and the X, Y, and Z axes to their "home" positions.
- Level Bed: Levels the Print Bed.
- Disable Steppers: Disables the Stepper Motors. To re-engage the motors, turn the printer off, then back on again.
- Wizard: Starts the Initial Setup Wizard.



## Control Menu

- Main: Returns to the Main Menu.
- Temperature: Displays the Adjust Temperature Screen.
- Z Offset Setting: Tests the current distance between the Nozzle and the Print Bed, then displays the Adjust Z Offset Screen.
- Wi-Fi Network: Displays the Wi®-Fi Network Menu.
- Language: Displays the Language Select Screen. The available languages are English, Chinese, French, German, Spanish, Italian, Japanese, Portuguese, Dutch, Turkish, and Korean.
- Machine Info: Displays the Machine Info Screen.
- Restore Default: Restores the printer's settings to their factory default values. Normally, this will not be needed, but should be done after performing a firmware update.



## Wi-Fi Network Menu

- Control: Returns to the Control Menu.
- Wi-Fi Device Info: Displays the Wi-Fi® module name, Wi-Fi module firmware version number, and IP address, SN number for the printer.



- Wi-Fi OTA Update: Checks the internet for the existence of a firmware update and performs the update if one is found.

## Move Axis Menu

- Prepare: Returns to the Prepare Menu.
- Move X: Displays the Move X Menu.
- Move Y: Displays the Move Y Menu.
- Move Z: Displays the Move Z Menu.
- Extruder: Displays the Move Extruder Menu.



## Move X/Y/Z/Extruder Menu

- Move Axis: Returns to the Move Axis Menu.
- Move 10mm: Displays the Move Screen, which allows you to adjust the X/Y/Z/Extruder position by 10mm each time the Knob is turned.
- Move 1mm: Displays the Move Screen, which allows you to adjust the X/Y/Z/Extruder position by 1mm each time the Knob is turned.
- Move 0.1mm: Displays the Move Screen, which allows you to adjust the X/Y/Z/Extruder position by 0.1mm each time the Knob is turned.



## Print Control Menu

While printing is in progress, press the Knob while on the Printing... Screen to display the Print Control Menu.

- Info Screen: Returns to the Printing Screen.
- Tune: Displays the TuneMenu.

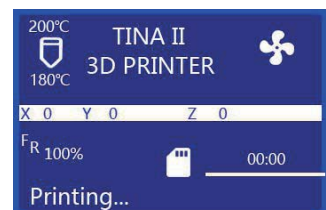

- **Pause Print:** Pauses the print and displays an alternate Print Control Menu, which allows you to resume the print and change the filament.
- **Resume Print:** Resumes the paused print.
- **Saving Print and Off:** Saves the state of the print, so you can turn the printer off. The next time the printer is powered on, it will display the Power Loss Recovery Menu.
- **Auto Feed Filament:** Performs the Loading Filament function.
- **Auto Retract Filament:** Performs the Unloading Filament function. This allows you to change the filament in the middle of a print.
- **Stop Print:** Cancels the print in progress without saving its state.

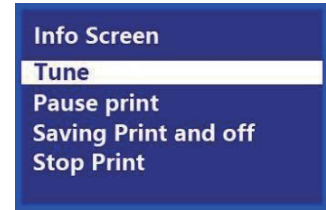

## Tune Menu

While printing is in progress, you can access the Tune Menu to make adjustments.

- **Main:** Returns to the Main Menu.
- **Speed:** Displays the Adjust Print Speed Screen, which allows you to change the printing speed on the fly.
- **Nozzle:** Displays the Adjust Temperature Screen, which allows you to change the Nozzle temperature on the fly.
- **Fan Speed:** Displays the Adjust Fan Speed Screen, which allows you to adjust the cooling fan speed on the fly.
- **Flow:** Displays the Adjust Flow Screen, which allows you change the speed at which filament is extruded on the fly. Note that reducing the speed too much can cause clogs in the Nozzle.
- **Z Offset Setting:** Displays the Z Offset Setting Screen, which allows you to adjust the Z offset on the fly.

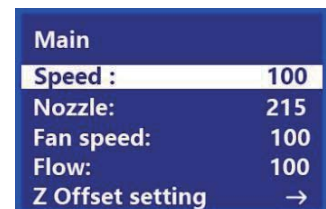

## Power Loss Recovery Menu

If power is lost during printing or if you previously selected the Saving Print and Off function from the Print Control Menu, the next time to turn the printer on, the Power Loss Recovery Menu is displayed, which allows you to continue the print from where it left off.

- Resume Print: Resumes the saved print.
- Stop Print: Cancels the saved print.

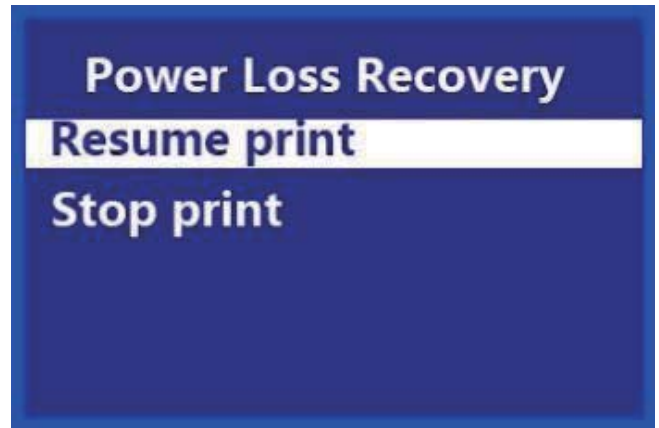

## COMMON MENU OPERATIONS

### Print from SD



1. On the Main Menu, rotate the Knob until the Print From SD option is highlighted, then press the Knob to enter the File Selection screen.
2. The File Selection screen shows all the .gcode files on the microSD™ card, sorted with the newest file at the top. Rotate the Knob to highlight the file you want to print, then press the Knob to start printing the file.

***Note that files stored on the microSD card are limited to 20 characters, not counting the .gcode file extension.***

## Loading Filament

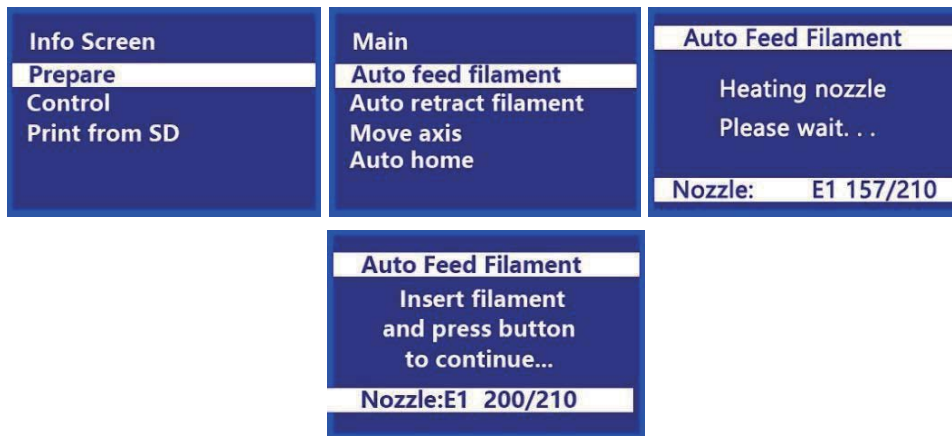

1. On the Main Menu, rotate the Knob until the Prepare option is highlighted, then press the Knob to enter the Prepare Menu.
2. Rotate the Knob until the Auto Feed Filament option is highlight, then press the Knob to continue.
3. Using a pair of scissors or side cutters, cut about an inch off the end of the filament, then gently straighten the end of the filament. Squeeze the lever on the Extruder, insert the filament into the bottom until you encounter resistance, then release the lever.
4. Press the Knob to start loading filament. Once filament starts extruding from the Nozzle,

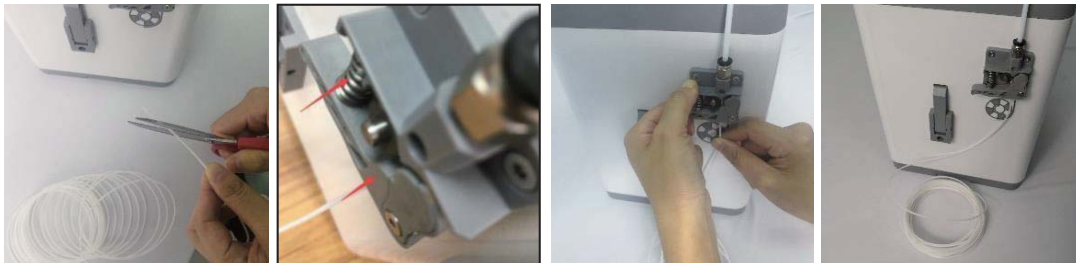

press the Knob again to stop extrusion. Clean the extruded filament, then press the Knob to select the Continue option.





## Unloading Filament

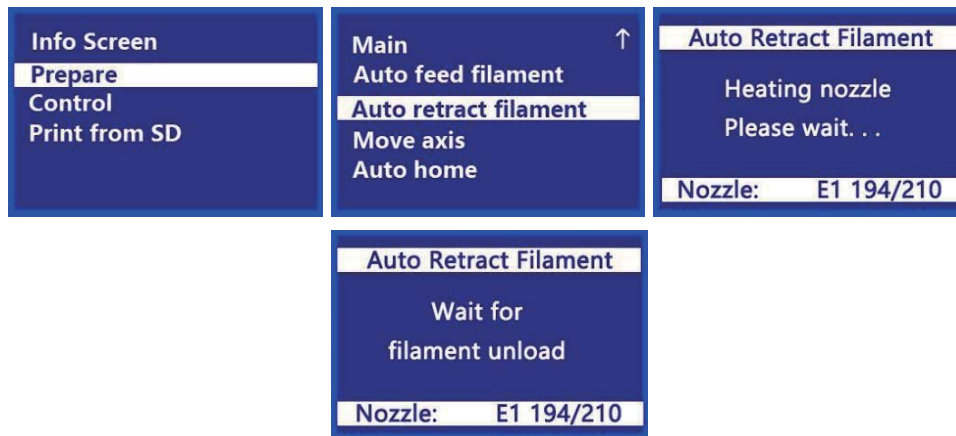

On the Main Menu, rotate the Knob until the Auto Retract Filament option is highlighted, then press the Knob. The Nozzle will heat to the target temperature. Once the target temperature is reached, the Extruder motor will retract the existing filament.

## Changing Filament

1. Perform the steps in the *Unloading Filament* section above.
2. Remove the filament spool from the Filament Holder, then place the new spool on the Filament Holder.
3. Perform the steps in the *Loading Filament* section above.

## Auto Home

The Auto Home function moves the Nozzle and Print Bed to the "home" positions.

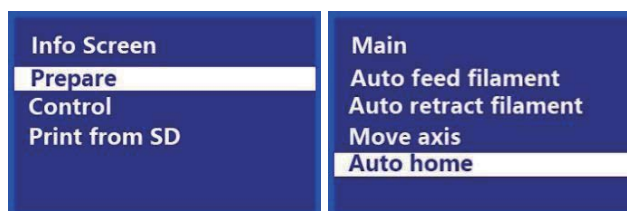

1. On the Main Menu, rotate the Knob until the Prepare option is highlighted, then press the Knob to enter the Prepare Menu.
2. Rotate the Knob until the Auto Home option is highlighted, then press the Knob. The Nozzle and Print Bed will move to the "home" positions.

## Move Axis

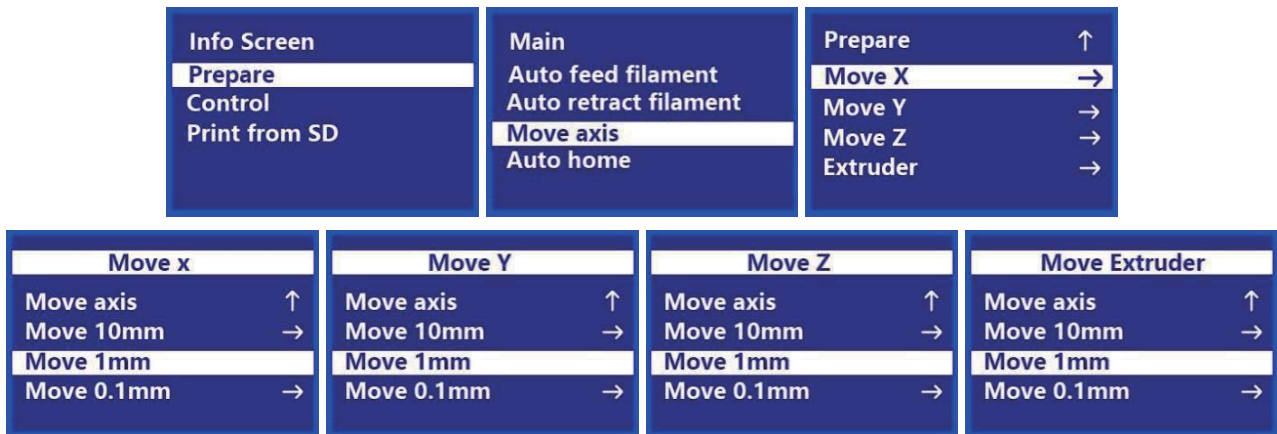

1. Perform the steps in the *Auto Home* section above.
2. On the Main Menu, rotate the Knob until the Prepare option is highlighted, then press the Knob to enter the Prepare Menu.
3. Rotate the Knob until the Move Axis option is highlighted, then press the Knob to enter the Move Axis Menu.
4. Rotate the Knob until the Move X, Move Y, Move Z, or Extruder option is highlighted, then press the Knob to enter the Move X, Move Y, Move Z, or Move Extruder Menu.
5. Rotate the Knob until the Move 10mm, Move 1mm, or Move 0.1mm option is highlighted, then press the Knob to move the selected axis by the indicated amount.

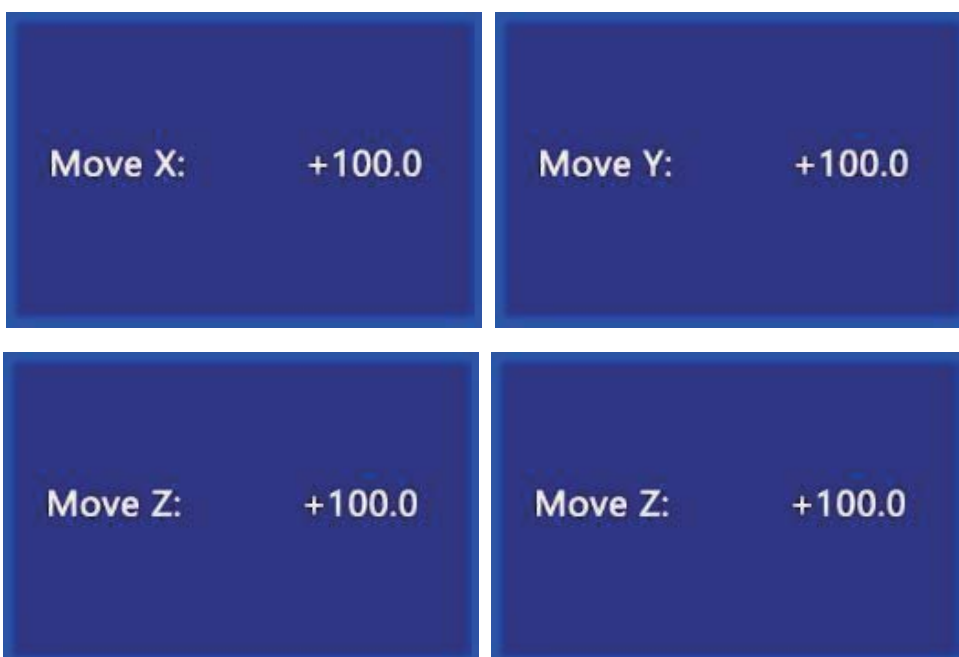



## Level Bed

*IMPORTANT! Ensure that the Magnetic Print Mat is installed on the Print Bed before performing the Level Bed procedure. Performing a Level Bed function without the Magnetic Print Mat will produce an invalid result.*

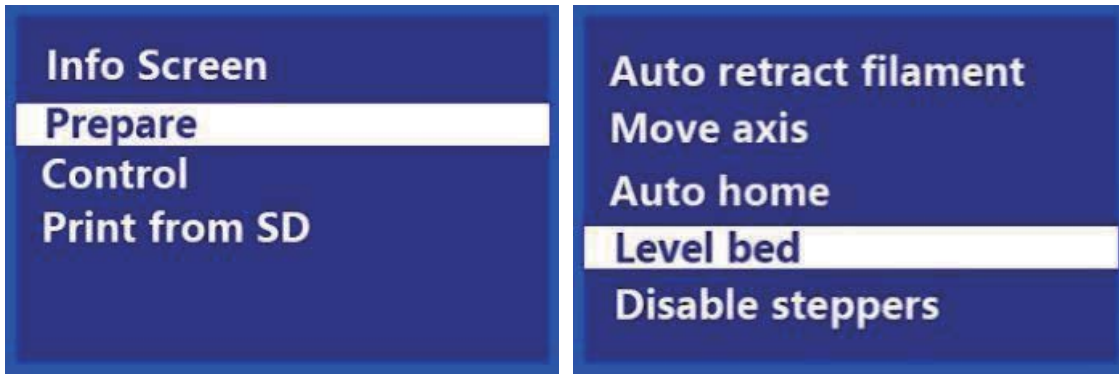

1. On the Main Menu, rotate the Knob until the Prepare option is highlighted, then press the Knob to enter the Prepare Menu.
2. Rotate the Knob until the Level Bed option is highlighted, then press the Knob to begin the Level Bed procedure.

## Disable Steppers

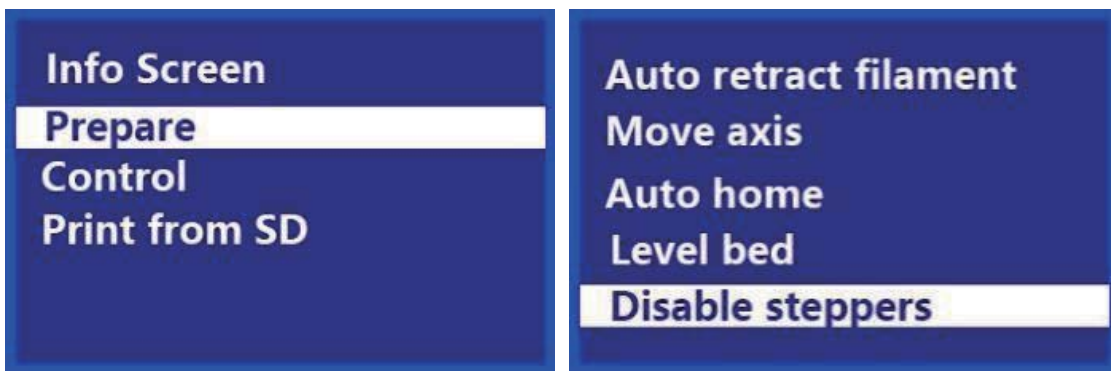

1. On the Main Menu, rotate the Knob until the Prepare option is highlighted, then press the Knob to enter the Prepare Menu.
2. Rotate the Knob until the Disable Steppers option is highlighted, then press the Knob to disable the Stepper Motors. The X, Y, and Z axes can now be independently moved by hand. To re-enable the Stepper Motors, turn the printer off, then turn it back on.

## Adjusting Target Temperature

The Target Temperature is the temperature to which the printer will heat the Nozzle. By default, the Target Temperature is set to 210°C.



1. On the Main Menu, rotate the Knob until the Control option is highlighted, then press the Knob to enter the Control Menu.
2. Rotate the Knob until the Temperature option is highlighted, then press the Knob to enter the Adjust Temperature Screen.
3. Rotate the Knob until the Nozzle option is highlighted, then press the Knob to edit the value.
4. Rotate the Knob to change the Target Temperature, then press the Knob to save the value.

## Z Offset Setting

The Z Offset Setting is used to adjust the distance between the Nozzle and the Print Bed. This can be done before printing or during printing. If the distance between the Nozzle and the Print Bed is too small, increase the Z Offset. If the distance between the Nozzle and the Print Bed is too large, decrease the Z Offset. The proper distance between the Print Bed and the Nozzle is when there is a slight amount of resistance when moving a piece of ordinary printer paper between the Nozzle and the Print Bed.

If you changed the Z Offset prior to printing, turn the printer off and then back on to save the setting as the default.

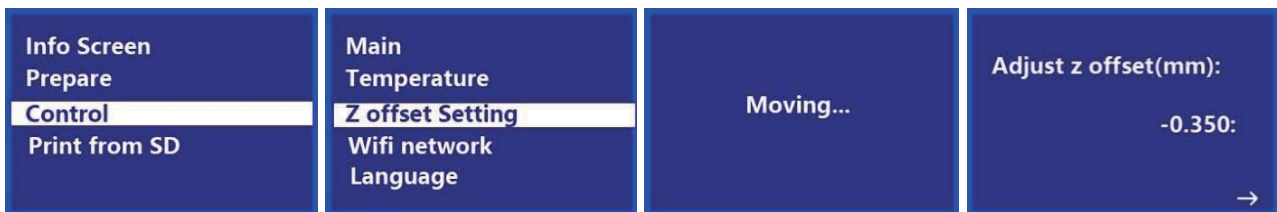

1. On the Main Menu, rotate the Knob until the Control option is highlighted, then press the Knob to enter the Control Menu.
2. Rotate the Knob until the Z Offset Setting option is highlighted, then press the Knob. The printer will test the distance from the Nozzle to the Print Bed in several places to determine the current Z offset. When it is done testing, the Adjust Z Offset Screen is displayed.
3. Place a sheet of ordinary printer paper between the Nozzle and the Print Bed. Rotate the Knob to adjust the Z offset until there is a slight amount of resistance when moving the paper around between the Nozzle and Print Bed.
4. When the proper Z offset is set, press the Knob to return to the Control Menu.

### Connect to Wi-Fi®



*Note that the Tina 2 printer does not support 5G Wi-Fi® networks and cannot connect if there are already 10 or more Wi-Fi connections.*

Step1: The name of the hotspot SSID is ESP32WIFI`XXXX`, which is the device seriesl number, and there is no password. You can search it on your phone or your PC.



Step2: Use your computer or mobile phone connect this WIFI.

Step3: Use a browser to access

<http://10.10.0.1:88/>

Then you can access to the WIFI network management page

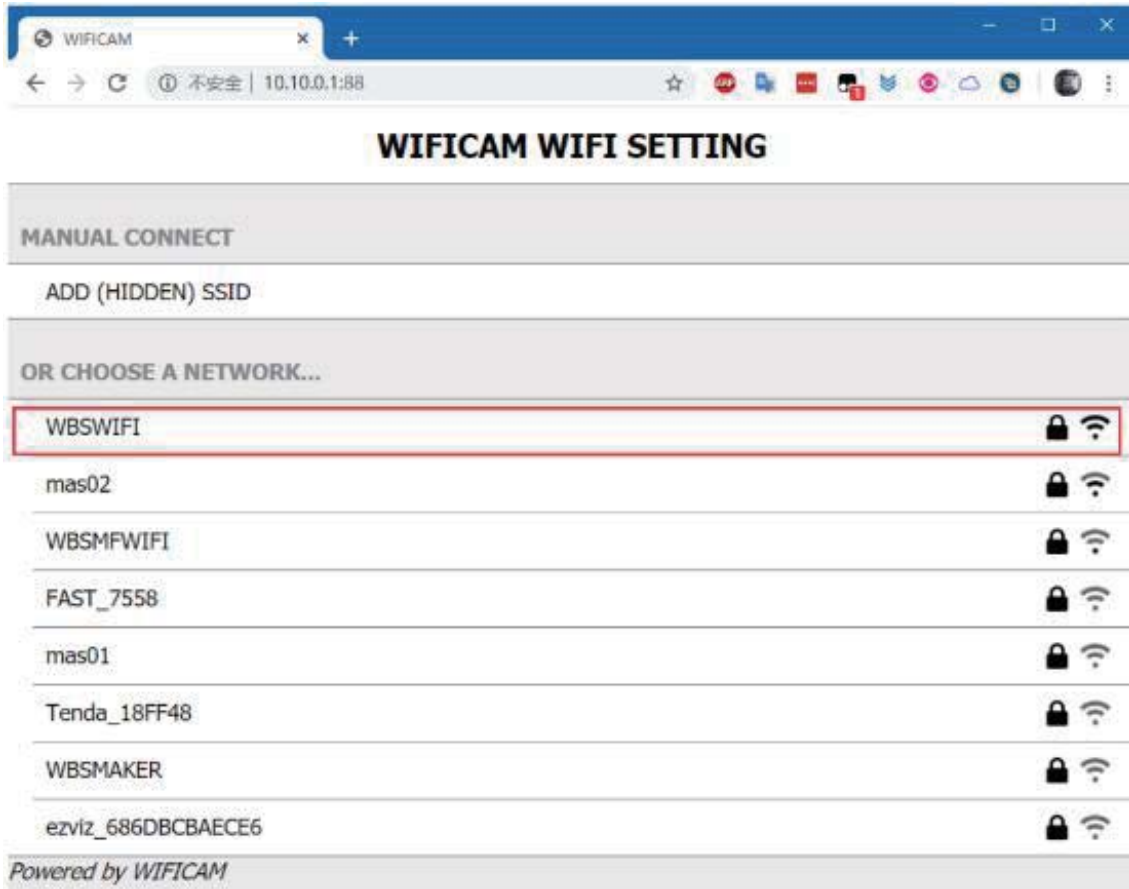

Step4: On this page, it can automatically scan the nearby WIFI network. Click on your network name, enter your WIFI password, and wait a moment, WIFICAM will try to connect to the network.

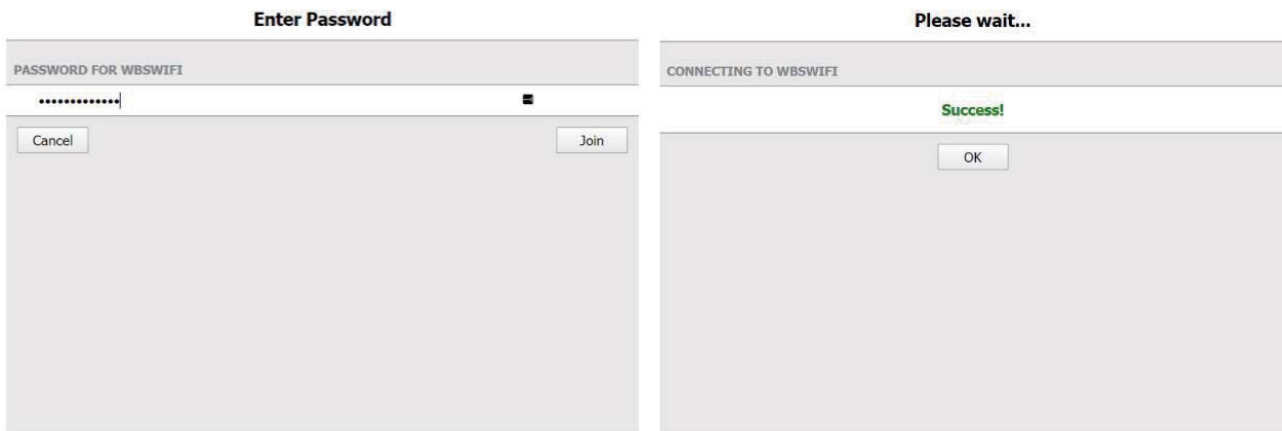

Step5: After WIFI is connected to the Internet, the obtained IP address will be displayed on the printer screen.

## Wi-Fi Device/Machine Info



1. On the Main Menu, rotate the Knob until the Control option is highlighted, then press the Knob to enter the Control Menu.
2. Rotate the Knob until the Wi-Fi Network option is highlighted, then press the Knob to enter the Wi-Fi® Network Menu.
3. Rotate the Knob until the Wi-Fi Device Info option is highlighted, then press the Knob to display the Machine Info Screen, which shows the Wi-Fi module name, Wi-Fi module firmware version number, and the IP address.
4. Press the Knob to return to the Wi-Fi Network Menu.

## Firmware Update

In the event that a firmware update is available, it will be made available on the internet. Perform the following steps to check for the existence of a firmware update and to perform the update, if one is available.



1. On the Main Menu, rotate the Knob until the Control option is highlighted, then press the Knob to enter the Control Menu.
2. Rotate the Knob until the Wi-Fi Network option is highlighted, then press the Knob to enter the Wi-Fi® Network Menu.
3. Rotate the Knob until the Wi-Fi OTA Update option is highlighted, then press the Knob. The OTA Update Screen will display. If new firmware has been found, press

the Knob to begin updating the Tina 2 firmware. If no new firmware is available, press the Knob to return to the Wi-Fi Network Menu.

## Changing Parameters While Printing

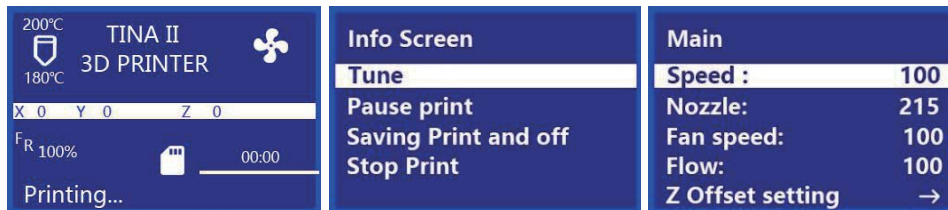

1. With the Printing... Screen displayed, press the Knob to display the Print Control Menu.
2. Rotate the Knob until the Tune option is highlighted, then press the Knob to display the Tune Menu.
3. Rotate the Knob until the parameter you want to adjust is highlighted, then press the Knob to displays that Adjust Screen for the selected parameter.
4. Change the value as desired, then select the Tune option to return to the Tune Menu.
5. Repeat for other parameters, as desired.

## Pausing and Resuming Print

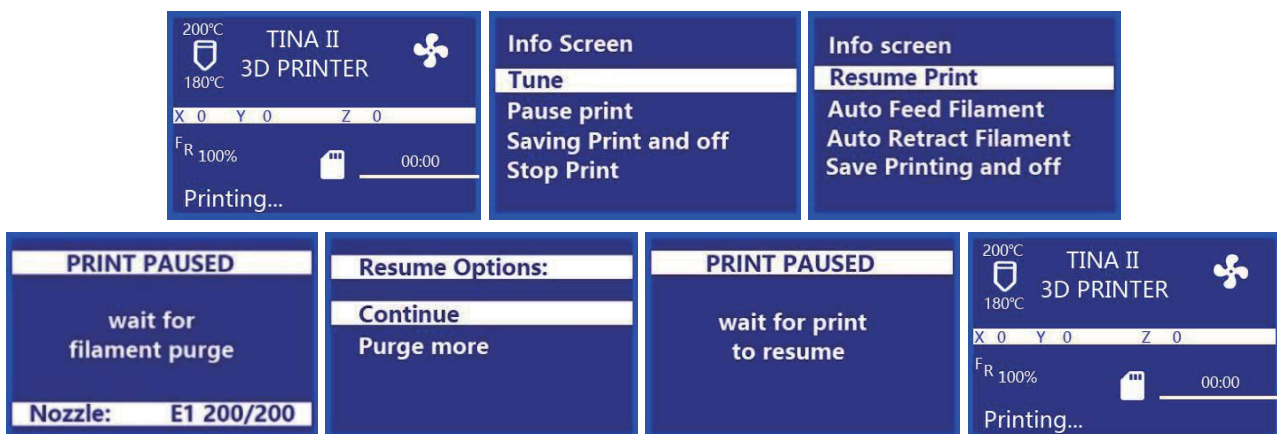

1. With the Printing... Screen displayed, press the Knob to display the Print Control Menu.



2. Rotate the Knob until the Pause Print option is highlighted, then press the Knob to pause the print. The printer will finish the current layer, then will pause printing.
3. When you are ready to resume the print, rotate the Knob until the Resume Print option is highlighted, then press the Knob to resume the print. The printer will heat the Nozzle to the target temperature, extrude a small amount of filament, then display the Resume Options Menu.
4. Clean the extruded filament, rotate the Knob until the Continue option is highlighted, then press the Knob to resume printing.

## Changing Filament While Printing

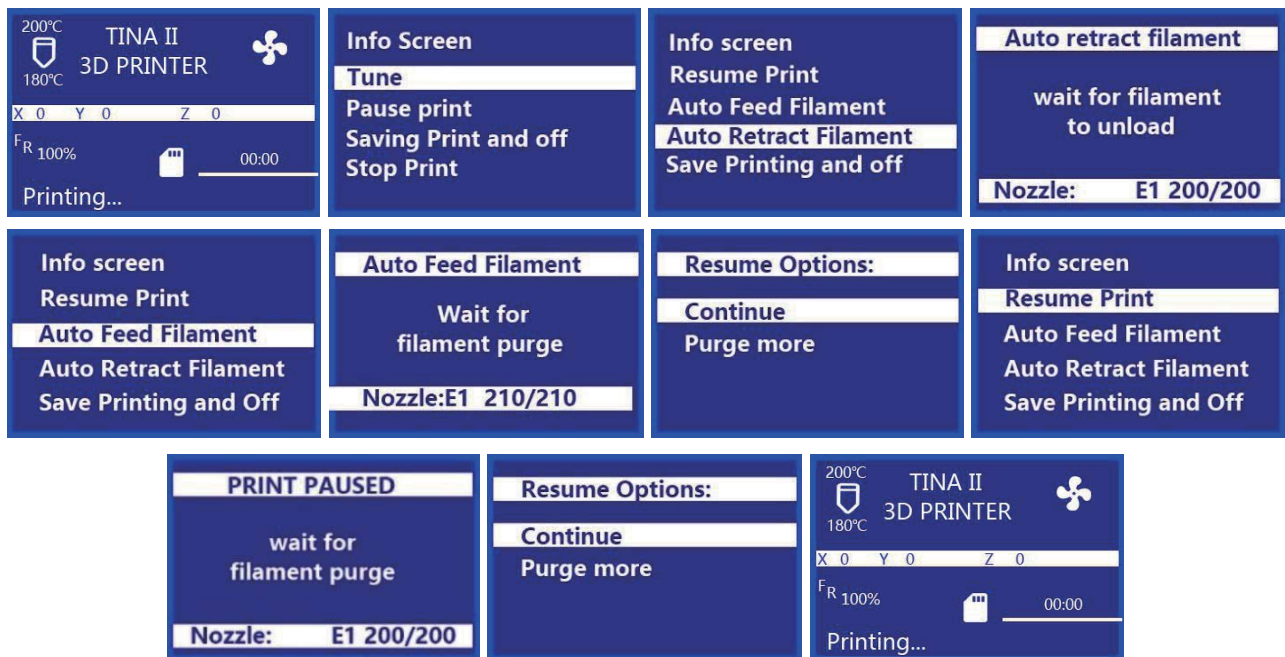

1. With the Printing... Screen displayed, press the Knob to display the Print Control Menu.
2. Rotate the Knob until the Pause Print option is highlighted, then press the Knob to pause the print. The printer will finish the current layer, then will pause printing.
3. Rotate the Knob until the Auto Retract Filament option is highlighted, then press the Knob to start the Unloading Filament process.
5. Once the filament has been unloaded, replace the spool of filament on the Filament Holder with a new spool of filament.

- Using a pair of scissors or side cutters, cut about an inch off the end of the filament, then gently straighten the end of the filament. Squeeze the lever on the Extruder, insert the filament into the bottom until you encounter resistance, then release the lever.
- Rotate the Knob until the Auto Feed Filament option is highlighted, then press the Knob

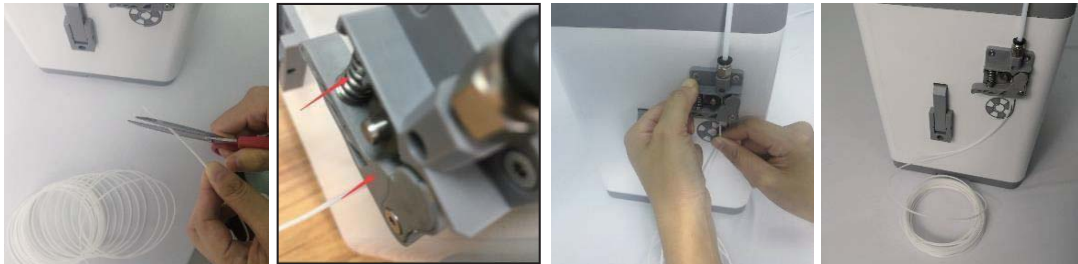

to start the Loading Filament function. The Nozzle will heat to the target temperature, if necessary, then will load the filament and extrude a small amount. Clean the extruded filament.

- Rotate the Knob until the Continue option is highlighted, then press the Knob to continue printing with the new filament.

## Saving a Print

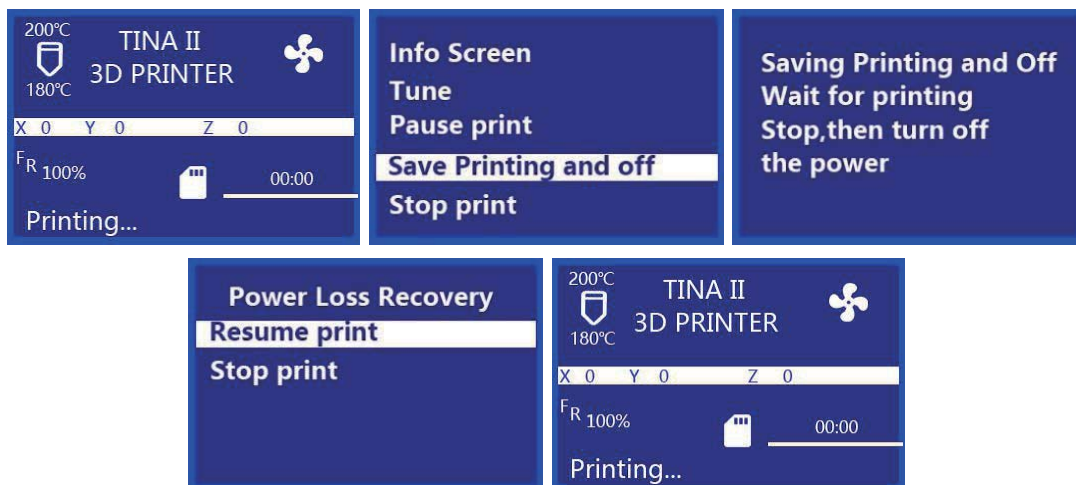

The Tina 2 printer features the ability saving a print in progress, so that you can turn the printer off and resume printing at a later time. Perform the following steps to save and resume a print in progress.

- With the Printing... Screen displayed, press the Knob to display the Print Control Menu.



2. Rotate the Knob until the Save Printing and Off option is highlighted, then press the Knob to save the print.
3. Wait for printing to stop, then turn the printer off.
4. When you are ready to continue the print, turn the printer on. The Power Loss Recovery Menu will display.
5. Rotate the Knob until the Resume Print option is highlighted, then press the Knob to continue the print. The printer will heat the Nozzle to the target temperature, then will resume the print.

### Continuing a Print After Power Loss

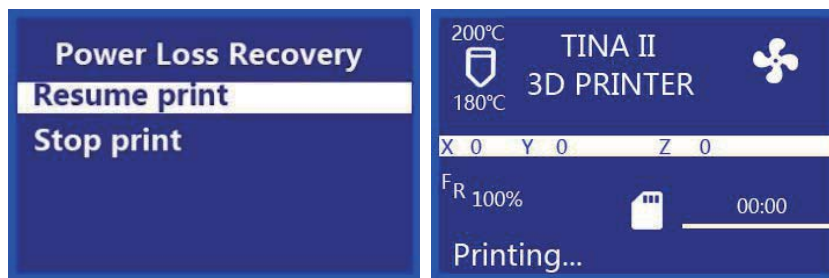

In the event that power is lost for any reason, the printer will remember where it was in the print process when power was lost. Perform the following steps to continue the interrupted print.

1. Turn the printer on. The Power Loss Recovery Menu will display.
2. Rotate the Knob until the Resume Print option is highlighted, then press the Knob to continue the print. The printer will heat the Nozzle to the target temperature, then will resume printing.

### Canceling a Print in Progress

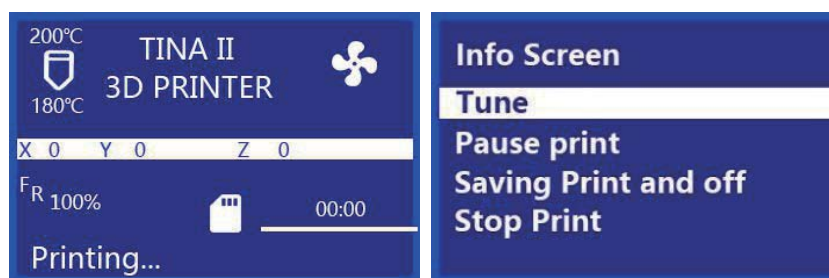

1. With the Printing... Screen displayed, press the Knob to display the Print Control Menu.

2. Rotate the Knob until the Stop Print option is highlighted, then press the Knob to cancel the print.

## Printing with the App

1. Launch the PoloPrint Pro app. The app will list models on the cloud. Each model's "card" shows the approximate amount of time it will take to print. To print a model, touch the model's "card", then touch the icon that appears in the lower right corner of the "card". The app will download the model file from the cloud. When the download is finished, it will start printing automatically.

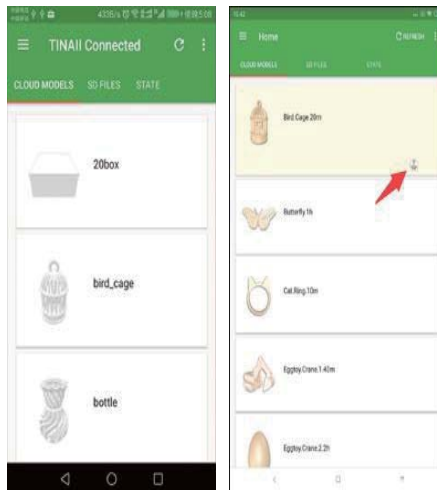

2. If you want to view the files on the microSD™ card, touch the SD FILES tab at the top of the screen. The app will display the files on the microSD card. To print a file, touch the "card", then touch the icon in the bottom right corner of the "card".

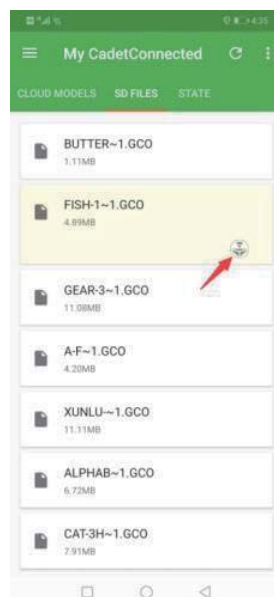

3. While the model is printing, you can see the progress of the print by touching the STATE tab at the top of the screen.

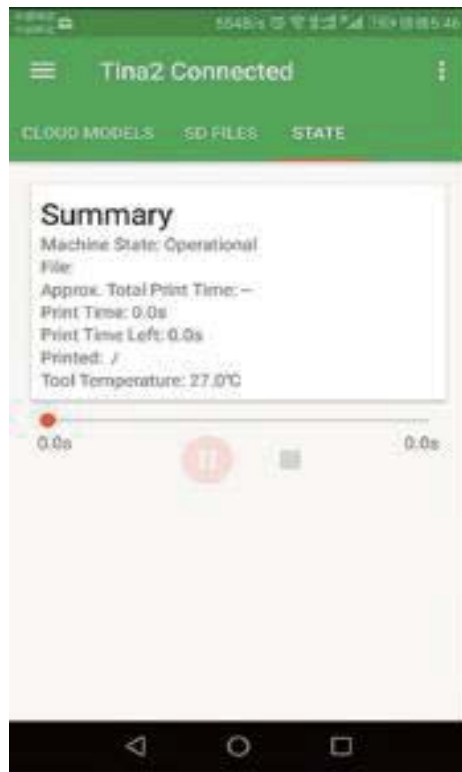

## WIIBUILDER SLICING SOFTWARE

### Installation

This printer includes a copy of WiiBuilder Slicing Software to turn 3D models into .gcode files for printing from the microSD™ card. The software on the included microSD card has been configured for use with the Tina 2 printer.

To install the software, double click the Wuiiuilder2.0.6.3\_ setup.exe (**Software version will be continuously updated**) installation file on the microSD card, then follow the steps below.

1. The installation wizard will first prompt you to select the installer language. The available languages are English, Japanese, and Simplified Chinese. Select your preferred language and click the OK button to continue.

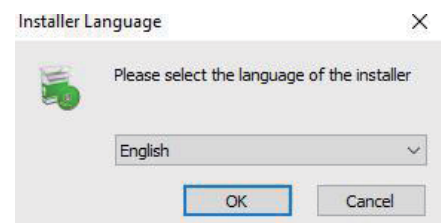

- The installer will then prompt you to select the directory to which WiiBuilder will be installed. If you do not want to use the default directory, click the Browse... button to open the file browser and select your preferred directory. Click the Next > button to continue.

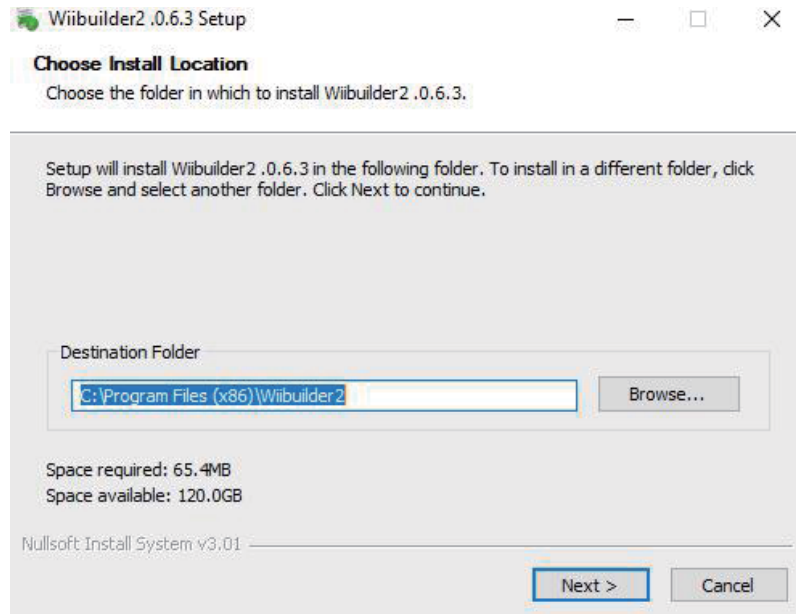

- The installer will prompt you to select the components you want to install. If you are unsure of which components you need, select all components. Click the Install button to start the installation process. If you already have a component installed, the installer will inform you and skip installation of that component.

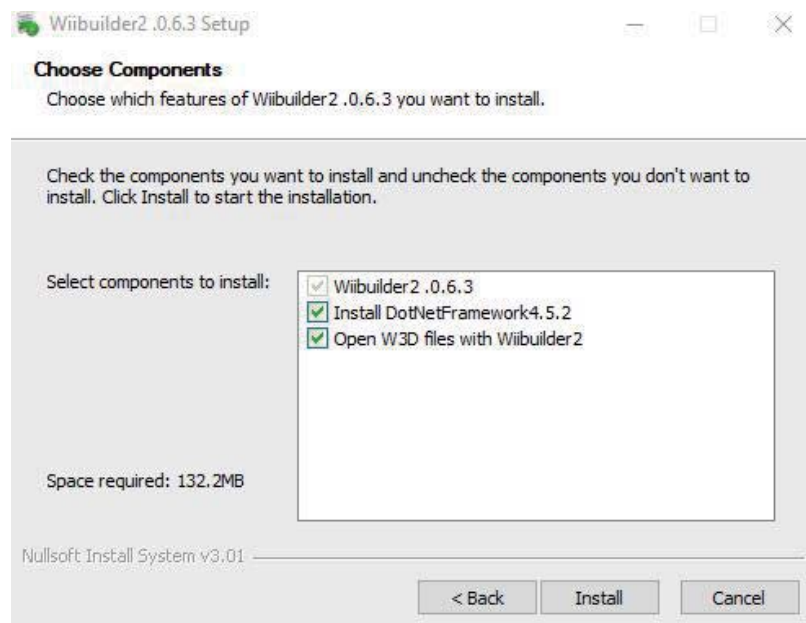

- The install wizard will extract the installation files and install the program. After installation is complete, click the Next > button to continue.

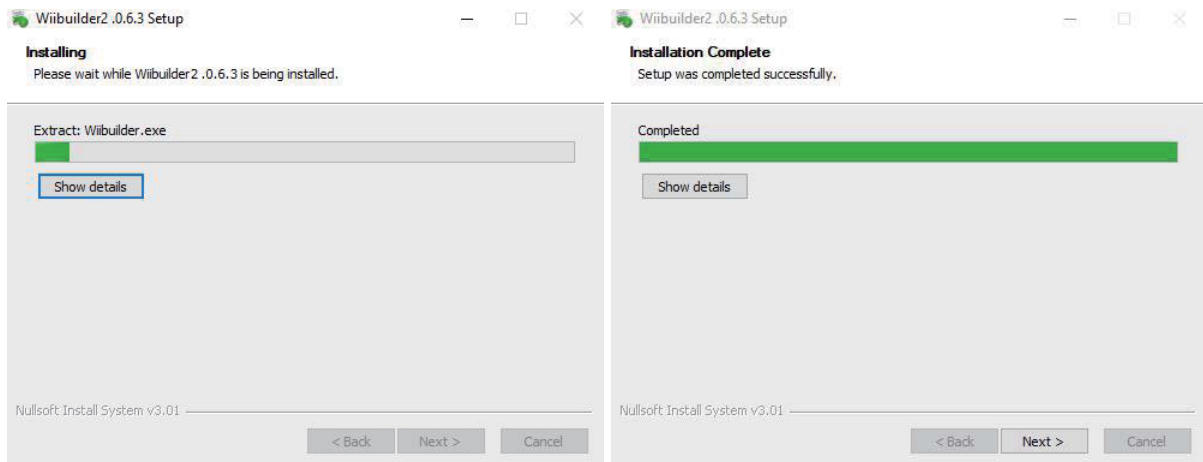

- By default, the installer has the Start WiiBuilder 2.0.6.3 option should be checked. If not, check the box, then click the Finish button to close the installer and launch WiiBuilder.

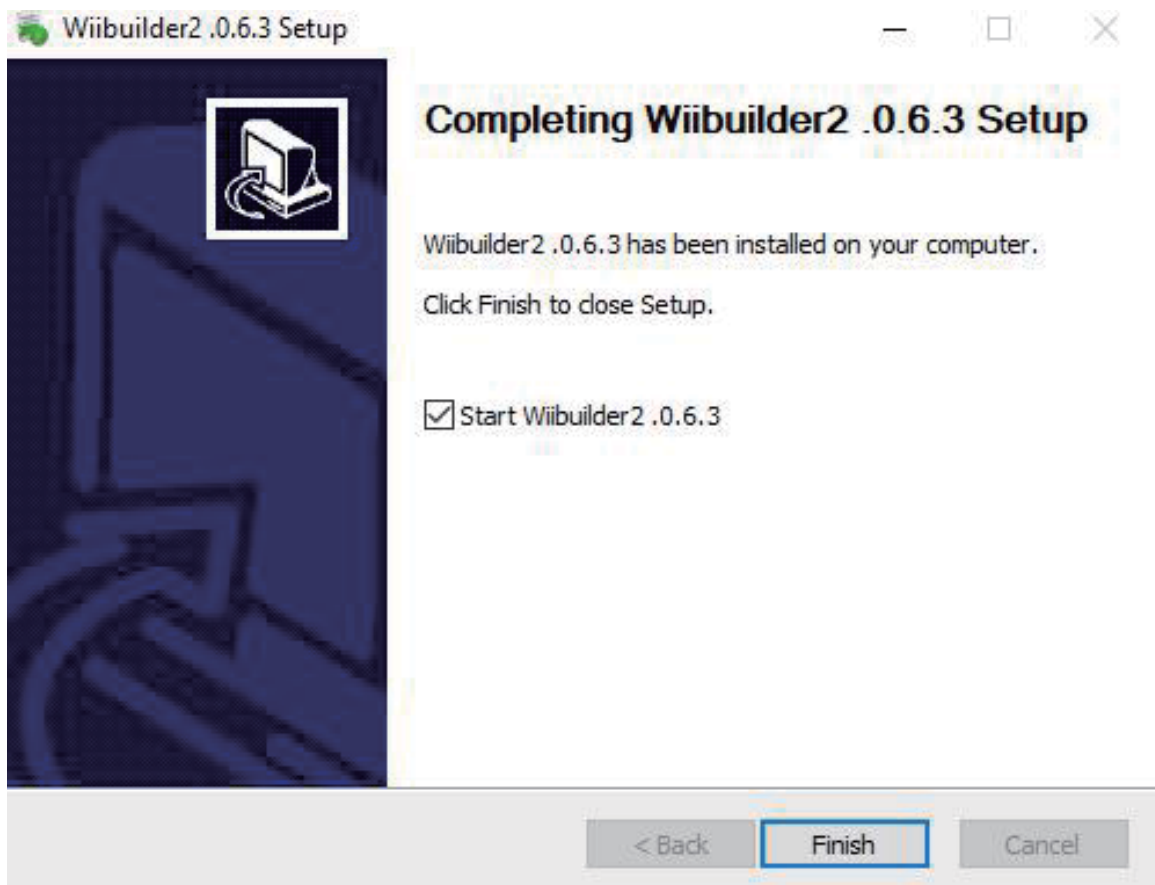

- Once WiiBuilder launches, it will launch a wizard that will display a series of six animated pages that show how to perform several common functions. Click the next button to view the next page. If you want to see a previous page, click the last button. Once all six pages have been displayed, click the finish button to close the wizard.

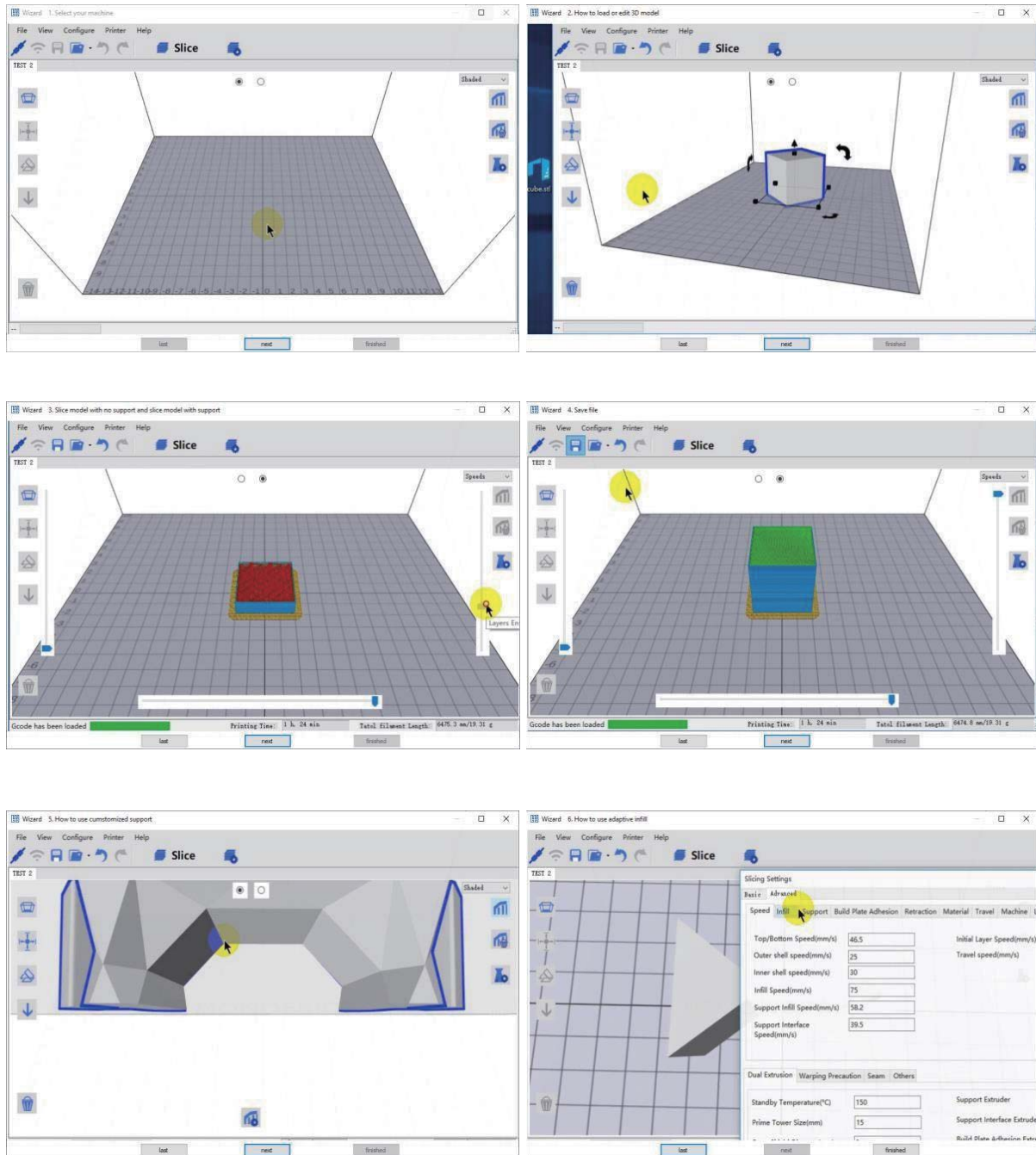

7. WiiBuilder now prompts you to select the Machine Type. Select the TINA 2 entry, then click the OK button to continue.

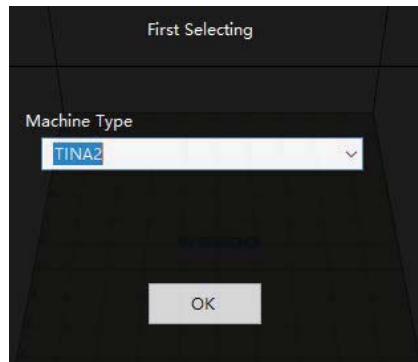

8. WiiBuilder is now configured and ready for use! If you want to see the wizard again, click Help > RunWizard. If you want to read the product manual, check the advanced function of WiiBuilder in TF card.

## SPECIFICATIONS

Model	TINA2 Basic/TINA/ TINA2 Pro
Printing Technology	Fused Filament Fabrication (FFF)
Supported Filament Types	PLA, PLA Pro,TPU
Filament Diameter	1.75mm
Nozzle Diameter	0.4mm
Maximum Nozzle Temperature	250°C
Build Volume	3.9" x 4.7" x 3.9" (100 x 120 x 100 mm)
Printing Accuracy	0.1 - 0.4 mm
Leveling Method	Automatic
Supported Slicing Software	WiiBuilder, Cura
Supported Model File Types	.STL, .OBJ, .gcode
Supported Inputs	microSD™ card, [Wi-Fi®, WLAN, USB( <i>Based on the printer Model</i> )]
Maximum microSD Card Capacity	8GB
Supported microSD Card Formatting	FAT32, 4096 bytes per sector
Dimensions	8.5" x 7.9" x 10.6" (215 x 200 x 270 mm)
Weight	6.6 lbs. (3.0 kg)





