

ENTINA • TINA2S

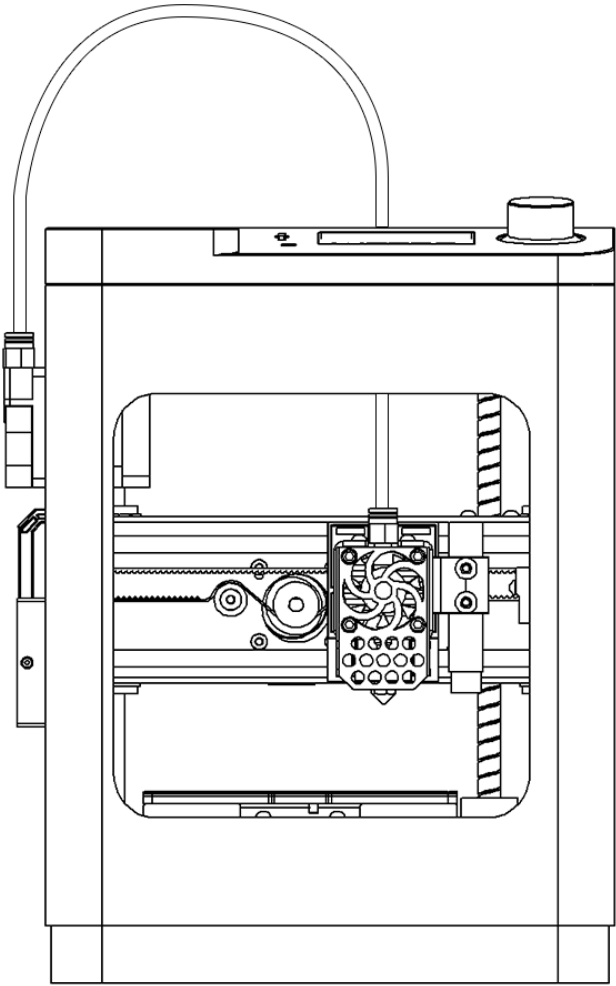

Unpacking guide

| NOTES

Please read this guide before using the device. Once you use this product, it means that you have read and accepted the following safety warnings.

If you have any questions, you can email support@entina3d.com or contact us using **Whatsapp** +86 18936012338 in 【 Poloprint Cloud 】 app.

| SAFETY WARNINGS

1. Do not touch the nozzle or stepper motors, when the 3D printer is printing or just finished the printing job, the nozzle temperature is up to 230°C.
2. Do not expose this device to water or moisture of any kind. Do not place drinks or other containers with moisture on or near the device. If moisture does get in or on the device, immediately unplug it from the power outlet and allow it to fully dry before reapplying power.
3. Prior to operation, check power cord for physical damage. Don't use if physical damage has occurred.
4. Before plugging the unit into a power outlet, ensure that the outlet provides the same type and level of power required by the device.
5. Unplug this device from the power source when not in use.
6. Take care to prevent damage to the power cord. Do not allow it to become crimped, pinched, walked on, or become tangled with other cords. Ensure that the power cord does not present a tripping hazard.
7. Never unplug the unit by pulling on the power cord. Always grasp the connector head or adapter body.
8. Ensure that the 3D printer is turned off and unplugged from its power source before making repairs or performing service.
9. You can check the video, manual and software in TF card.

| PRODUCT OVERVIEW

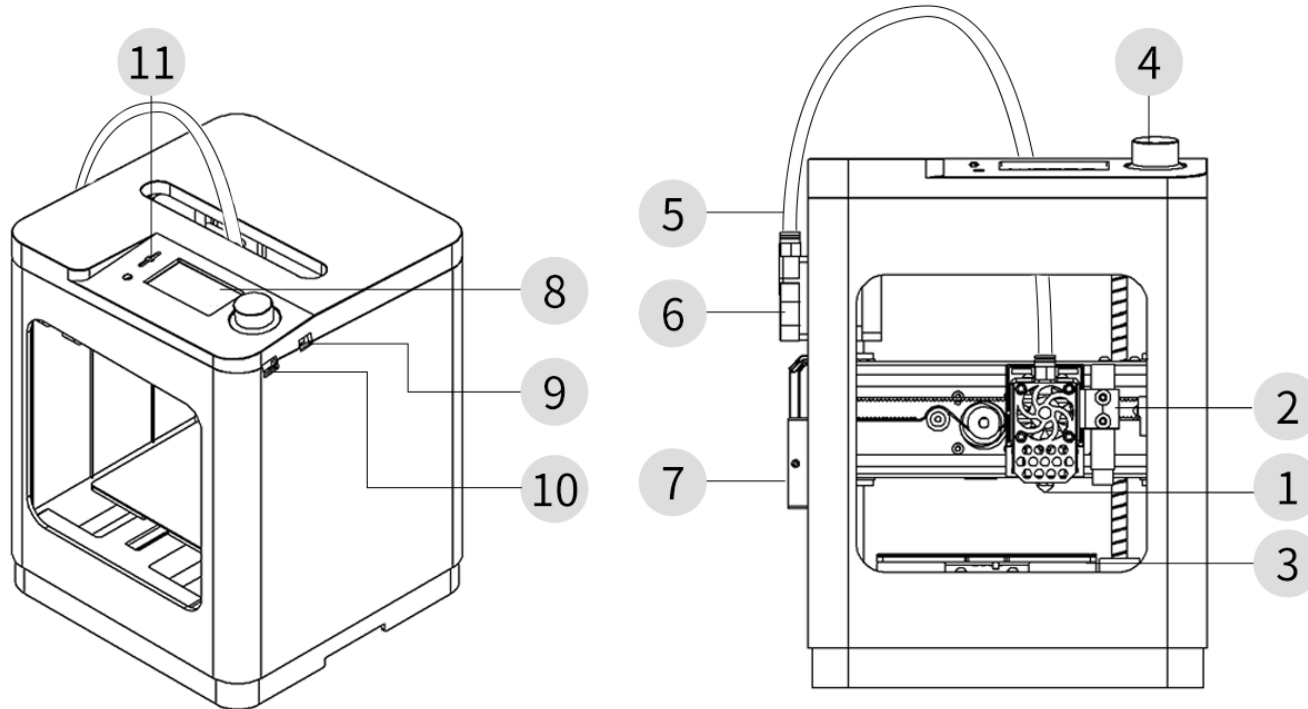

1. Hotend

2. Proximity Sensor

3. Platform

4. Knob Button

5. Filament Tube

6. Extruder

7. Filament Holder

8. Screen

9. Power Socket

10.USB Socket

11.TF Card Socket

| ACCESSORIES

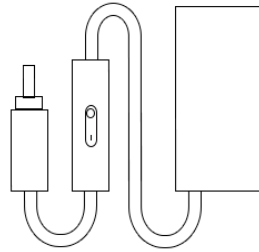
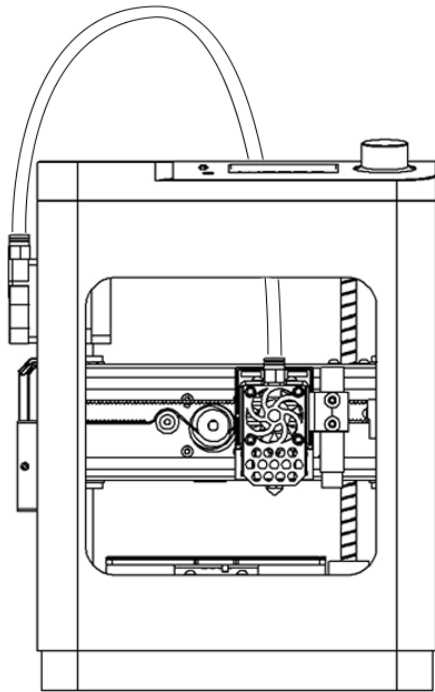

power cable

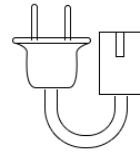

power supply

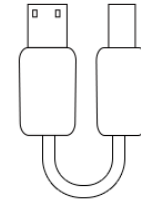

USB

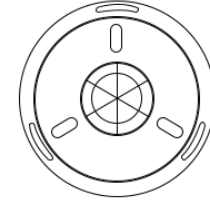

filament



solid glue

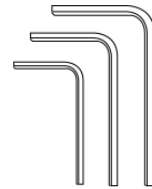

1.5/2.0/2.5mm
L wrench



6mm
wrench



0.4mm
nozzle



card reader



Type-C



TF card

test models
software
manual and video

| SPECIFICATION

Model TINA2S	Product Volume 210*210*290 mm	Build Volume 100*105*100 mm	Motherboard Silent TMC2208
Weight 3Kg/6.6lbs	Nozzle Diameter 0.4mm	Power Supply 100V- 240V/12V@5A,60W	Platform Flexible Spring Steel
Nozzle Temp ≤245°C	Heatbed Temp ≤60°C	Speed ≤200mm/s	Input TF Card / APP / WIFI / USB
Layer Thickness 0.1~0.4mm	Printing Precision ±0.1mm	Leveling 3 points Auto Leveling	Environmental 15°C - 25°C

| SOFTWARE

Slicing Software Wiibuilder (WIN/macOS) Cura (WIN/macOS) OctoPrint (Pi OS/Linux)	Slicer Input File STL/OBJ/AMF	Printing Format Gcode	APP PP Cloud (Android/ iOS) PP Local (Android/ iOS)
--	---	---------------------------------	--

| FILAMENT

Filament Type PLA / PLA+ / TPU	Filament Diameter 1.75mm	Filament Temperature <230°C	Filament on Holder ≤500g
--	------------------------------------	---------------------------------------	------------------------------------

Please use the filament provided by our company. Filaments have different specifications, which can clog and damage the nozzle. If the 3D printer fails due to the 3-party, the warranty will not be granted.

If the filaments are not used for a long time, please keep them sealed.

| UNPACKING

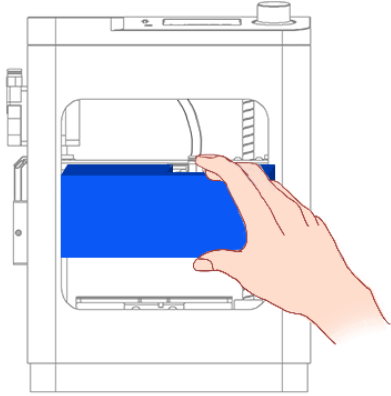

1. Unpack and remove foam.

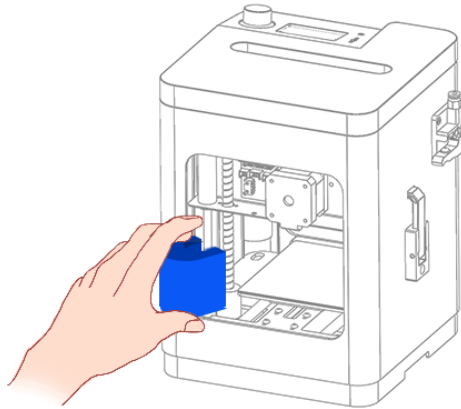

2. Remove the shaft coupling shell.

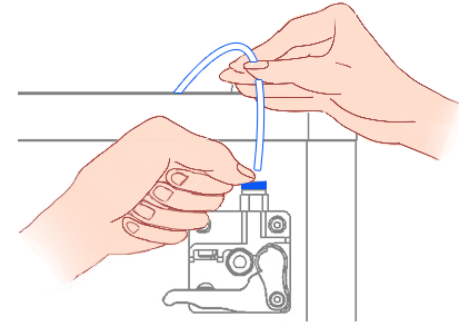

3. Press tube fitting to insert filament tube into extruder.

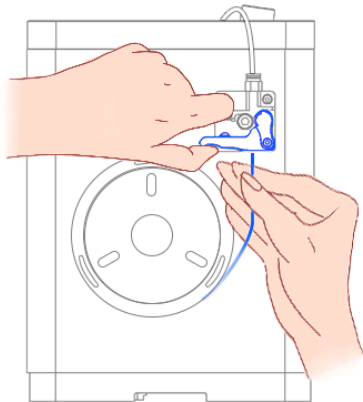

4. Press the extruder switch, straighten filament and insert it, until entering nozzle.

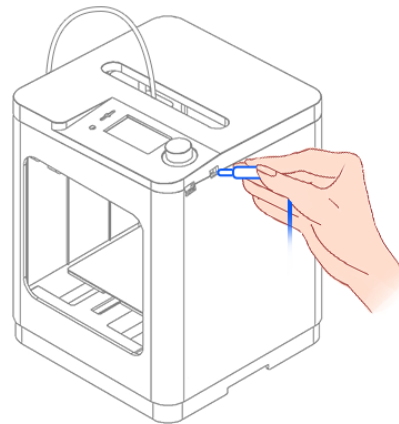

5. Plug in the power and turn on the printer.

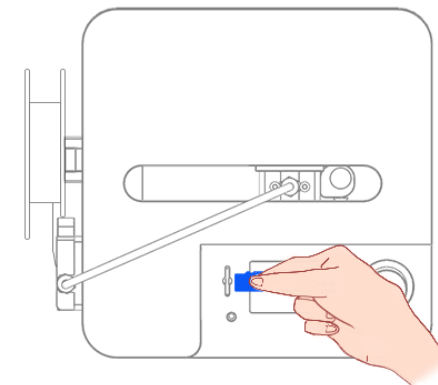

6. Insert the TF card and start printing.

| APP

① Poloprint Cloud -- install

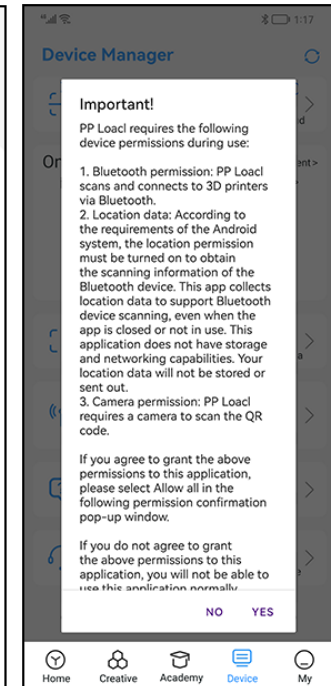
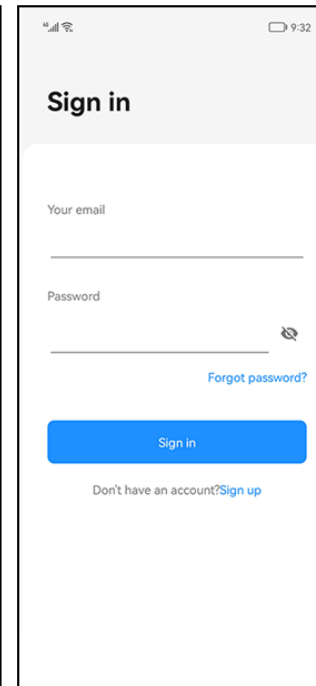
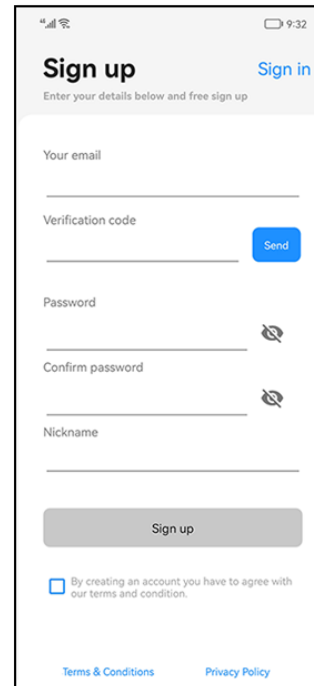

1. Scan or search to download Poloprint Cloud.

2. Sign up and sign in.

3. Click "Device" , allow all permissions.

Note:

1. If you are a beginner, please check out the usage guide in the app.
2. Please agree to "ALLOW ALL THE TIME".

② Poloprint Cloud -- configure WIFI for 3D printer

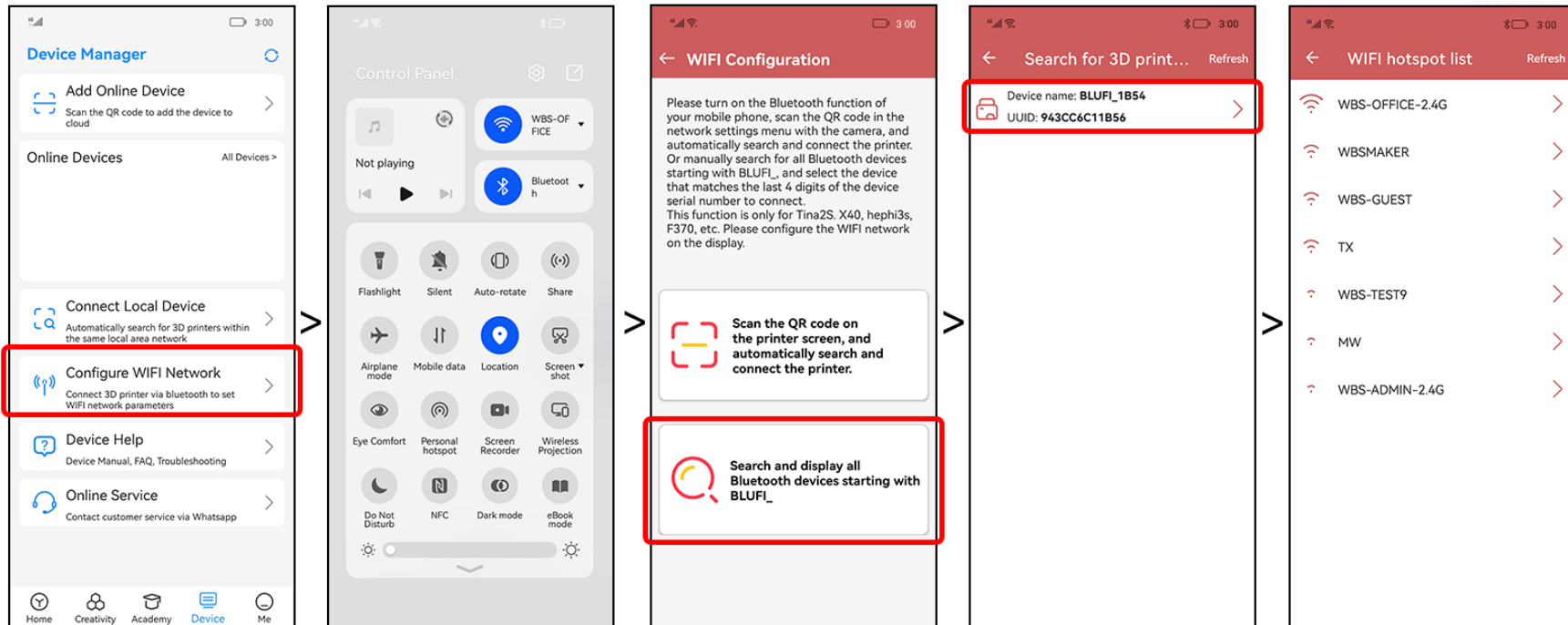

1. Choose "WIFI Configuration".

2. Turn on "Bluetooth" and "Location".

3. Scan the code or search bluetooth.

4. Click "bluetooth".

5. Select 2.4G WIFI, enter the password.

Note:

1. The list will only show 2.4G network. Doesn't support 5G.
2. Tina2s will display the IP on the screen if the connection is successful.

③ Poloprint Cloud -- connect 3D printer

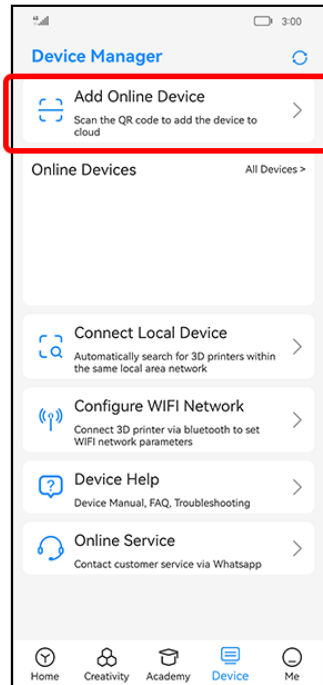

1. Click "Add online device".

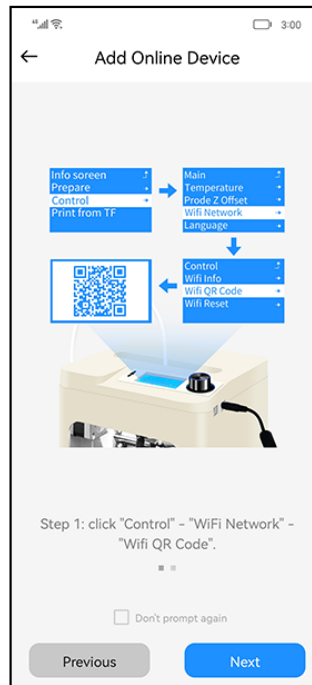

2. Operate according to the tutorial.

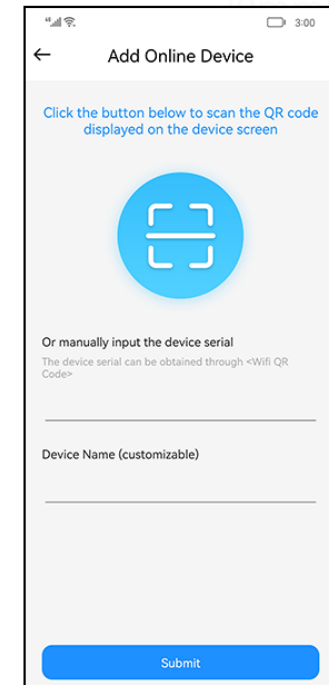
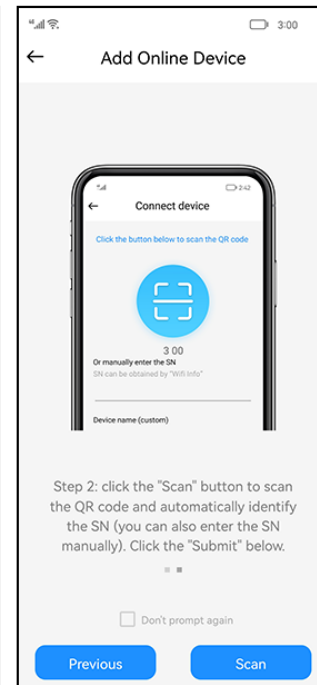

3. Scan and submit.

Note: This action will add your device to the cloud server.

④ Poloprint Cloud -- print model

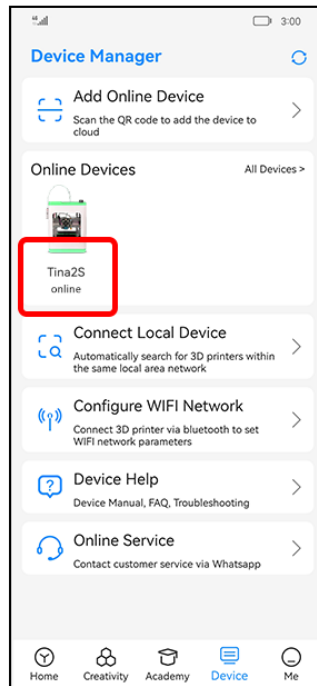

1. After the device is "online".

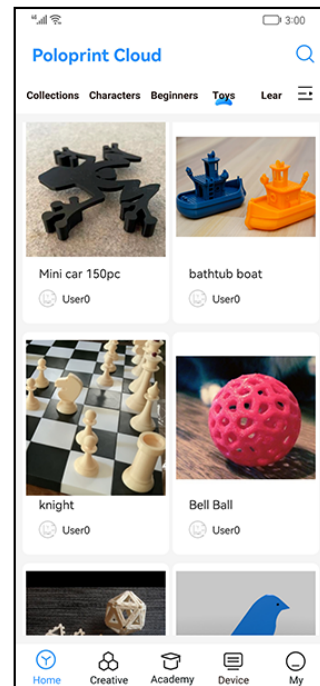

2. Choose a model.

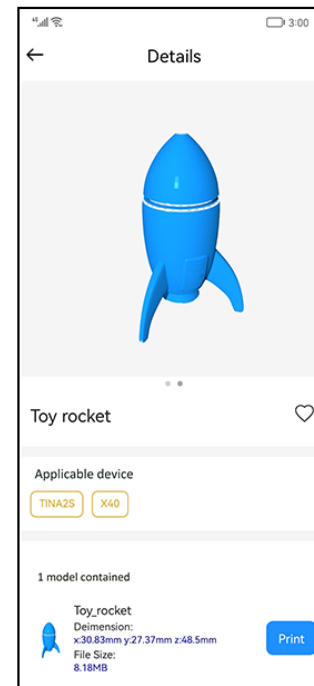

3. Click "Print".

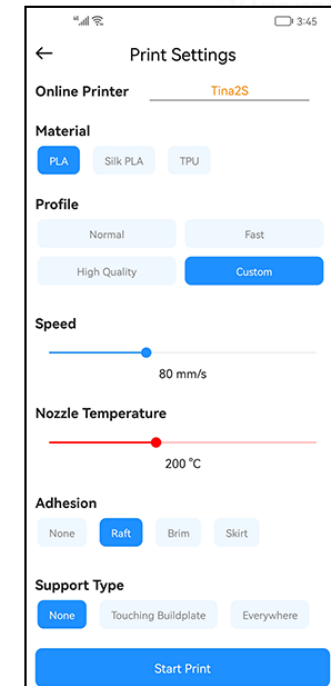

4. Set slice parameters, click "Start Print".

Note:

1. The TF card must be inserted, otherwise the transmission will fail.
2. Click "Custom" to select more parameters.

⑤ Poloprint Cloud -- control 3D printer

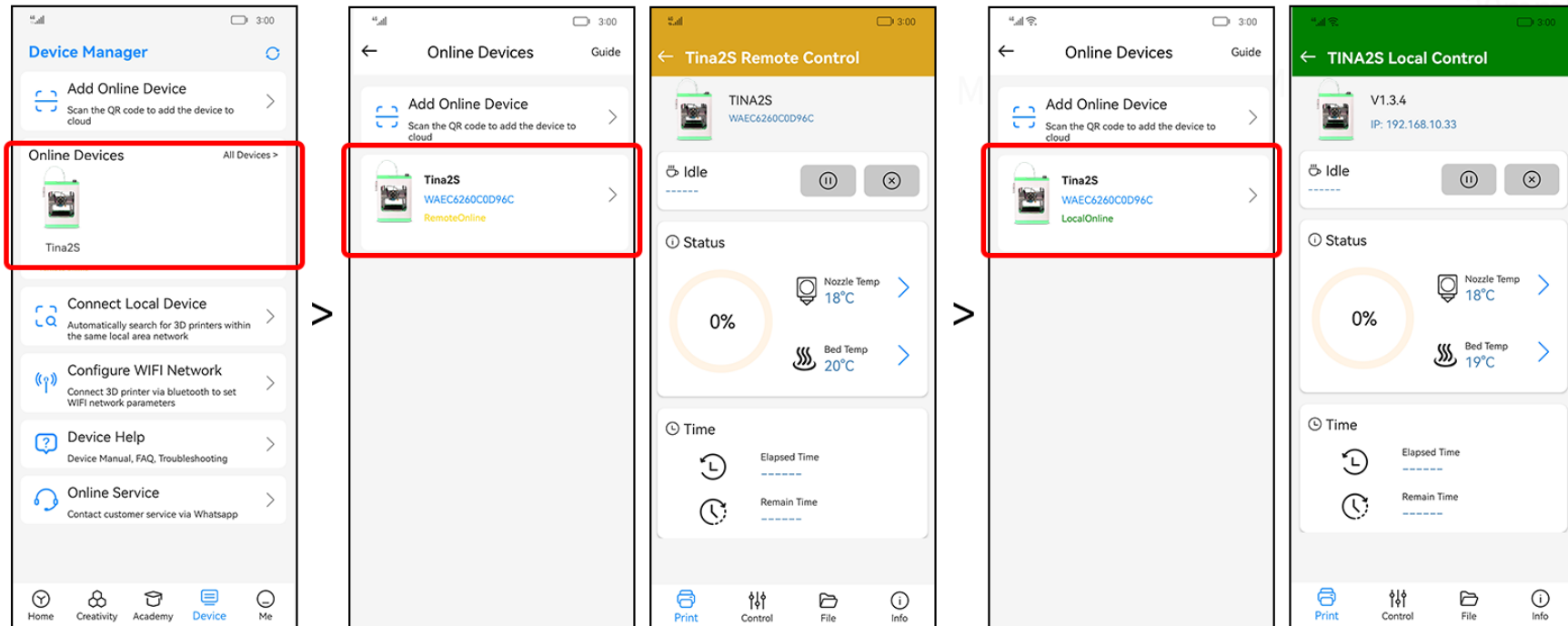

1. The app and the device are under different networks, "remote control" can be used.

2. Under the same network, it is "local control".

Note:

1. "Local online" transfers faster than "remote online".
2. "Local online" has more control functions.

⑥ Poloprint Cloud -- local device

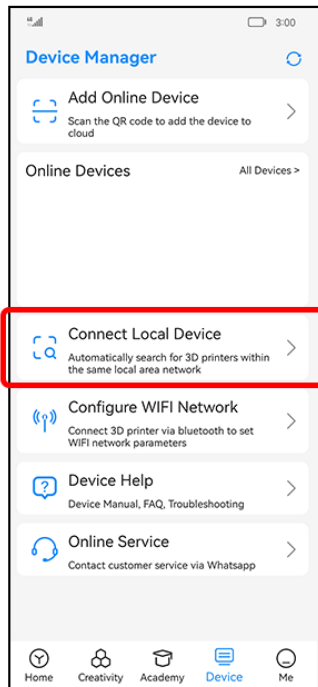

>

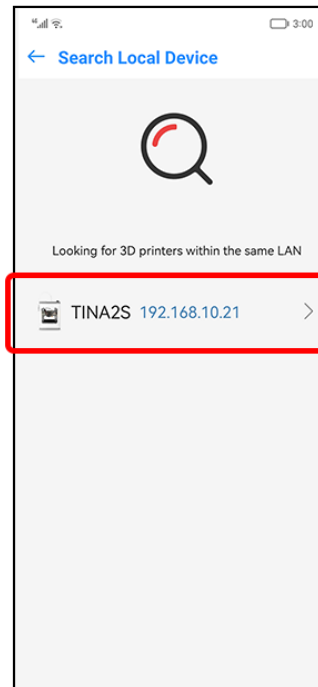

>

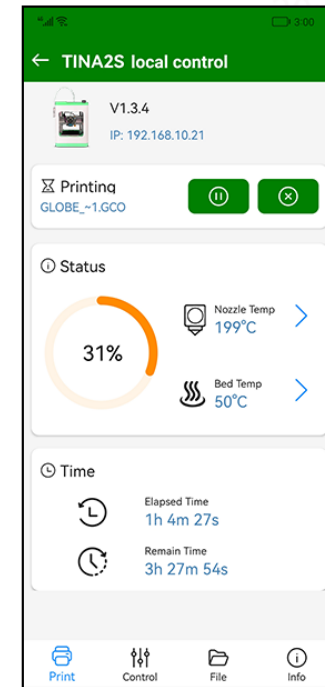

1. If the user doesn't want to access the cloud server, the local device can be used.

2. Click the IP.

Note: The app must be under the same network as the device.

| PC

① Wiibuilder -- install and add models

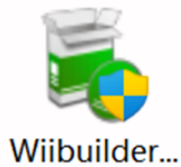

1. Download and install Wiibuilder.

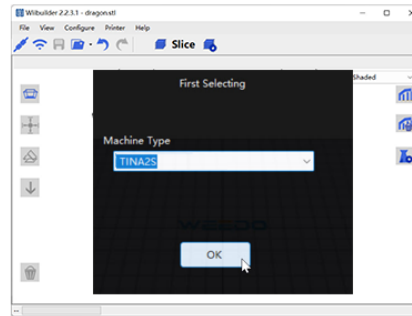

2. Open the Wiibuilder.
Select the printer.

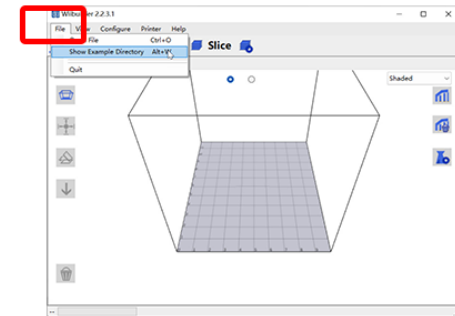

3. Click "File" to load the model,
or just drag the model into it.

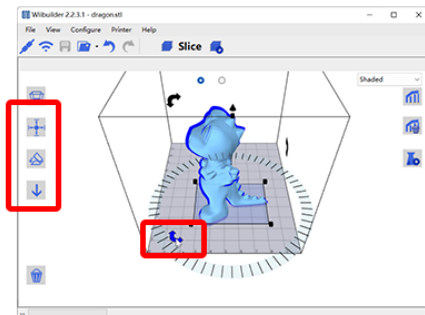

4. Click and adjust the model.

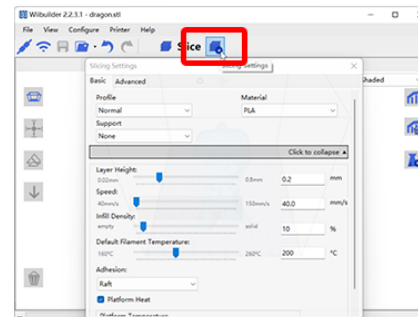

5. Set slicing parameters .

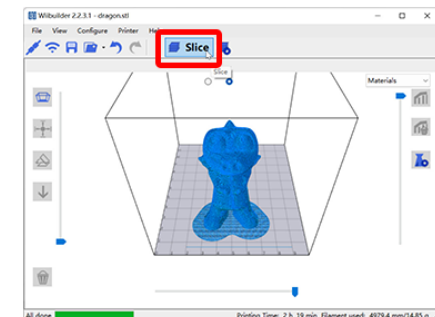

6. Click "Slice" .

Note: The installation has been stored in the TF card.

② Send files by TF card

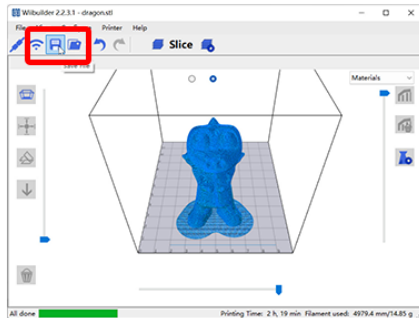

1. Click "Save File".

>

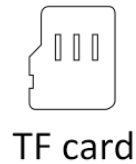

2. Save file to the TF card.

>



3. Insert the TF card into the printer. Print the file.

③ Send files by the network

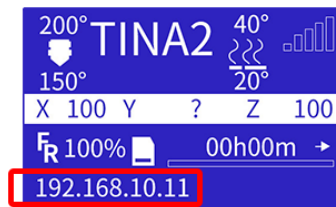

1. The info screen show the IP address.

>

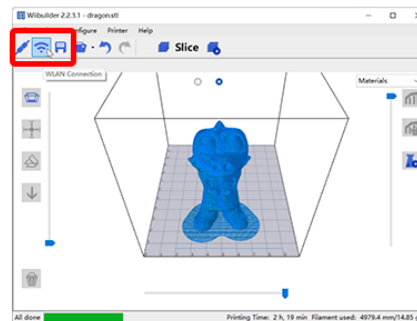

2. Click "WLAN Connection".

>

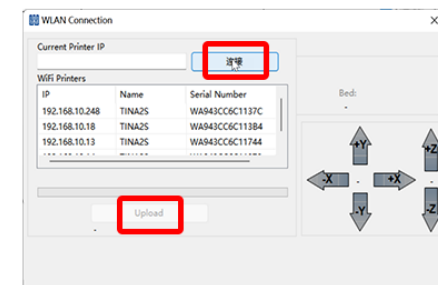

3. Choose IP address, click "Connect", "Upload".

④ Send files by USB

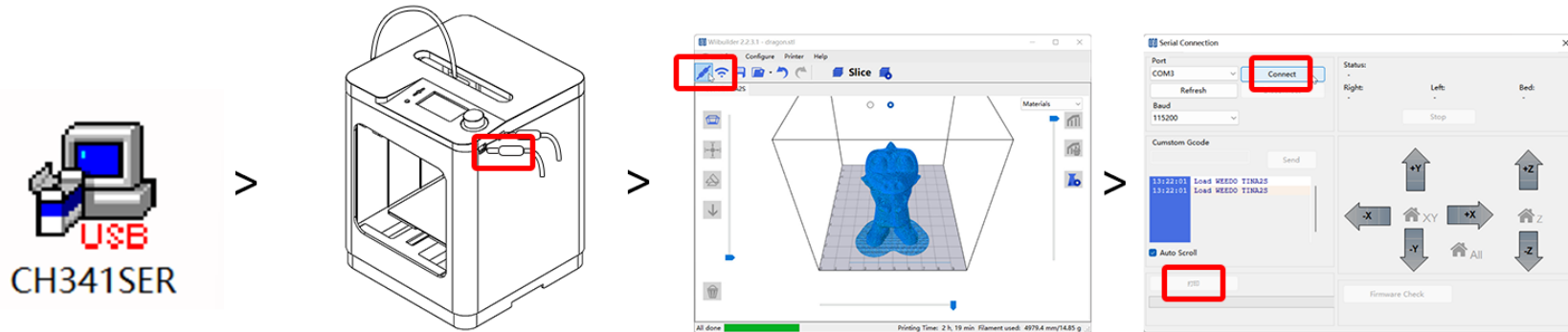

1. The USB driver in the TF card should be installed first.

2. Connect Tina2s and computer with USB.

3. Click "Connect Printer".

4. Click "Connect".
Click "Print".

| HELP

1. Users can inquire more about 3D printer knowledge in Poloprint Cloud and manual.
2. If the device fails, you can check **【Academy】**, or **【Device】** - **【Device Help】** in Poloprint Cloud. You can also use the **【Log】** function (LAN) in Poloprint Cloud.
3. If you have problems that can't be solved, please contact technical support via email or Whatsapp in Poloprint Cloud.