

3 D / P R I N T E R

ENTINA

3D
PRINTER

EN

USER'S MANUAL

ENTINA
3D
PRINTER

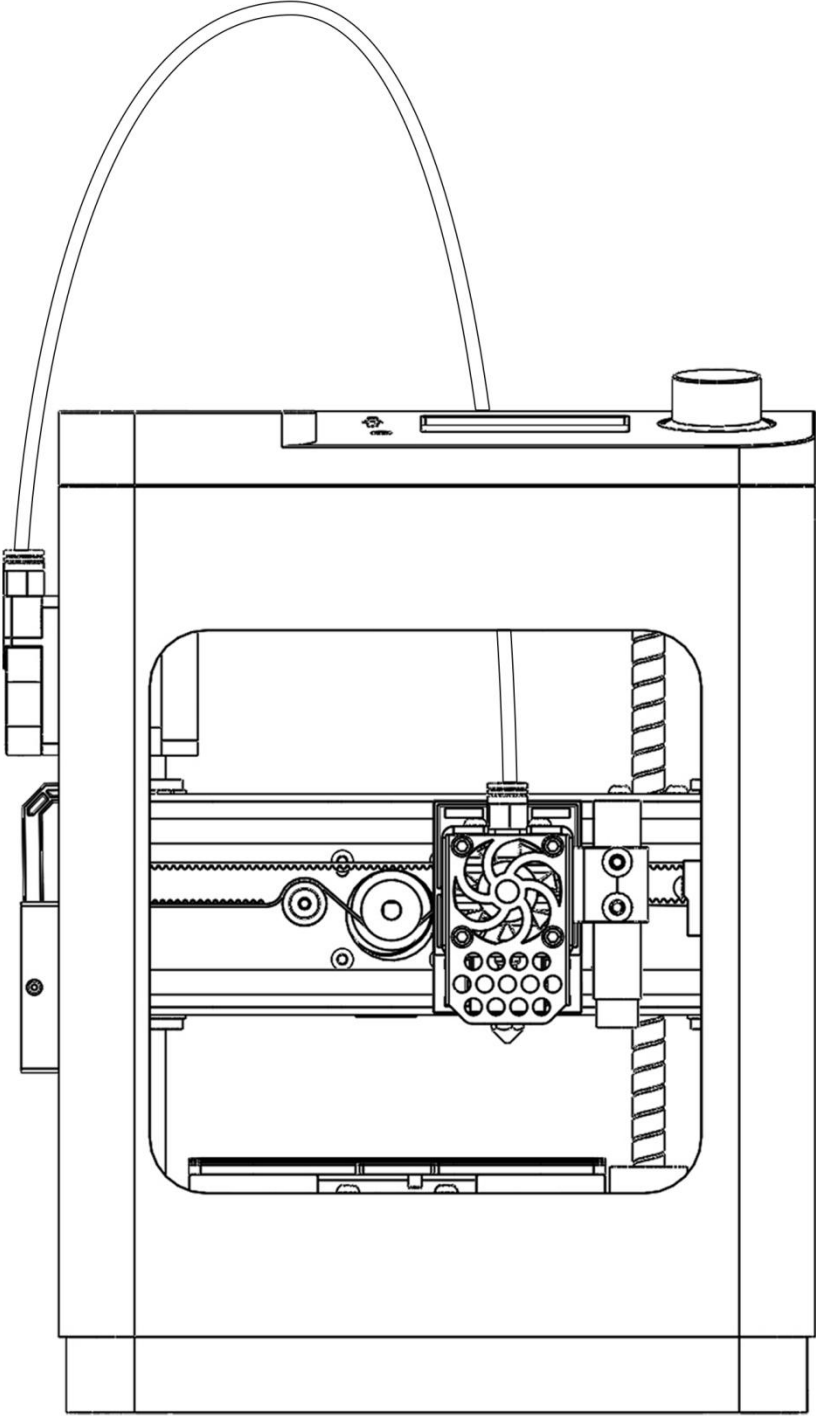

CONTENTS

1. NOTES	1
1.1. Safety Warnings	1
1.2. Filament	1
1.3. Environmental Requirements	2
2. INTRODUCTION	3
2.1. Specification	3
2.2. Product Overview	4
2.3. Motherboard and Adapter Board	4
2.4. Internal Structure	5
3. SYSTEM MENU	6
3.1. Basic Menu Control	7
3.2. Info Screen	7
3.3. Prepare Menu	8
3.4. Control Menu	12
3.5. Print from TF	17
4. COMMON MENU OPERATIONS	21
4.1. Load Filament	21
4.2. Unload Filament	21
4.3. Print from TF Card	21
4.4. Common setting during printing	22
4.5. Power On Resume Print	23
5. WIFI NETWORK	24
5.1. File connect network	23
5.2. EspBluFi connect network	23
6. WIIBUILDER SLICING SOFTWARE	27
6.1. Installation	27
6.2. Interface Introduction	28
6.3. Add Model	30

6.4. Adjust The Model	31
6.5. Basic Parameter Settings	32
6.6. Send Files by The Network	32
6.7. Send Files by TF Card	34
6.8. Send Files by USB	35
6.9. Advanced Parameter Settings	36
7. PRINT BY APP	45
8. COMMON FAULTS	47
8.1. Filament Feeding Failure	47
8.2. Printing Failure	47
8.3. Other issues	50
8.4. Maintenance	51

1. NOTES

PLEASE READ THIS MANUAL BEFORE USING THE DEVICE, PAYING EXTRA ATTENTION TO THESE SAFETY WARNINGS AND GUIDELINES. PLEASE KEEP THIS MANUAL IN A SAFE PLACE FOR FUTURE REFERENCE.

1.1. Safety Warnings

- Do not touch the nozzle or stepper motors, when the 3D printer is printing or just finished the printing job, the nozzle temperature is up to 230°C.
- Do not expose this device to water or moisture of any kind. Do not place drinks or other containers with moisture on or near the device. If moisture does get in or on the device, immediately unplug it from the power outlet and allow it to fully dry before reapplying power.
- Do not touch the device, the power cord, or any other connected cables with wet hands.
- Prior to operation, check the unit and power cord for physical damage. Do not use if physical damage has occurred.
- Before plugging the unit into a power outlet, ensure that the outlet provides the same type and level of power required by the device.
- Unplug this device from the power source when not in use.
- Take care to prevent damage to the power cord. Do not allow it to become crimped, pinched, walked on, or become tangled with other cords. Ensure that the power cord does not present a tripping hazard.
- Never unplug the unit by pulling on the power cord. Always grasp the connector head or adapter body.
- Ensure that the 3D printer is turned off and unplugged from its power source before making repairs or performing service.

1.2. Filament

To use this 3D printer, please use the filament provided by our company. Filaments sold in the retail market have different specifications and uneven quality, which can easily clog and damage the nozzle and motor. If the 3D printer fails due to the use of third-party consumables, the warranty will not be granted.

If the filaments are not used for a long time after unpacking, please seal them and preserve them. PLA will absorb moisture when exposed to air for a long time, affecting the quality of printed products.

1.3. Environmental Requirements

This 3D printer is intended for indoor use only. The ideal ambient temperature is 15°C - 25°C. When the ambient temperature is lower than 10°C, the printing model is hard to adhere to the platform. When the ambient temperature is lower than 0°C, the device will not startup. When the ambient temperature is higher than 30°C, the print quality will decline significantly and the nozzle may be clogged.

2. INTRODUCTION

2.1. Specification

Model	TINA2S
Printing Technology	FDM
Build Volume	100 x 105 x 100mm /3.9''x 4.0''x 3.9''
Nozzle Diameter	0.4mm
Layer Thickness	0.1-0.4mm
Platform Material	Flexible Spring Steel
Leveling Technology	3 Points Auto Bed Leveling
Maximum Nozzle Temperature	245°C
Motherboard	Silent Motherboard with TMC2208
Maximum Heated Bed Temperature	60°C
Maximum Printing Speed	200mm/s
Printing Precision	±0.1mm
Product Weight	3Kg/6.6lbs
Power Supply	AC 100-240V, DC 12V5A, 60W
Filament Diameter	1.75mm
Supported Filament Type	PLA / PLA+ / TPU
Supported Filament Weight	100g-250g, with built in filament holder 1Kg, with filament rack (extra purchase)
Supported Slicing Software	Wiibuilder (Windows/MacOS) Cura-ENTINA (Windows/MacOS) OctoPrint (Pi OS/Linux)
Supported Model File Types	STL/OBJ/GCODE
Input Method	TF Card / WIFI / USB / APP
APP	PoloPrint Pro (Android/IOS)

2.2. Product Overview

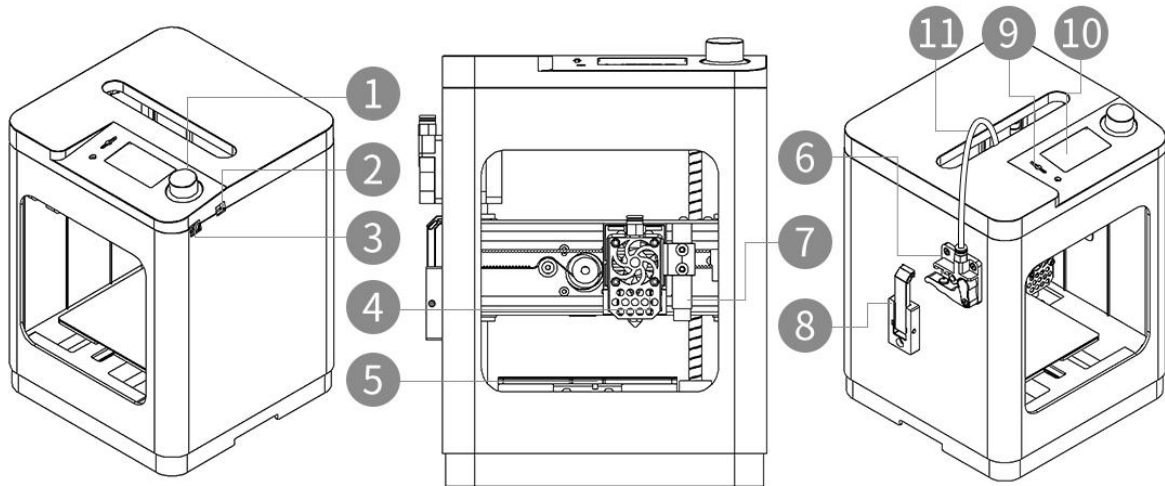

- | | | |
|---|------------------------|-----------------|
| 1. Knob | 2. Power socket | 3.USB socket |
| 4. Hotend (Heat break, Heated aluminum block, Nozzle) | 5. Heated Bed Platform | 6. Extruder |
| 7. Proximity Sensor | 8. Filament Holder | 9. TF Card slot |
| 10. Screen | 11. Filament Tube | |

2.3. Motherboard and Adapter Board

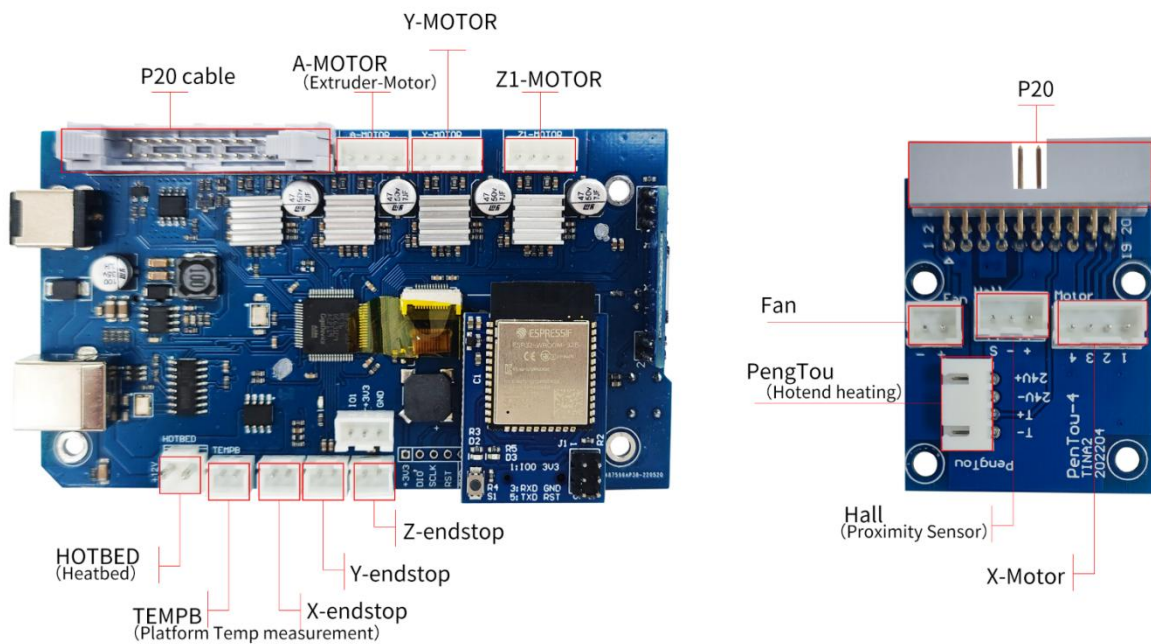

2.4. Internal Structure

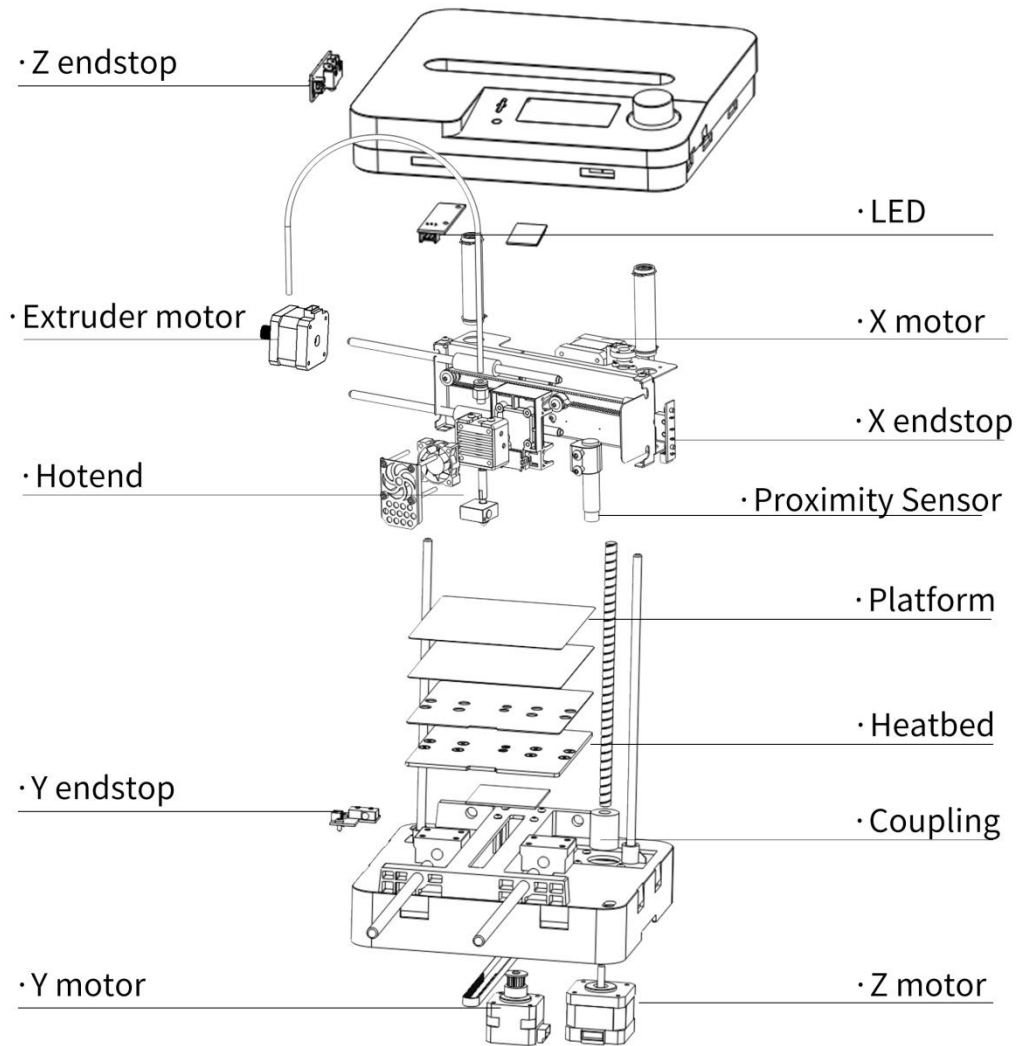

Hotend:

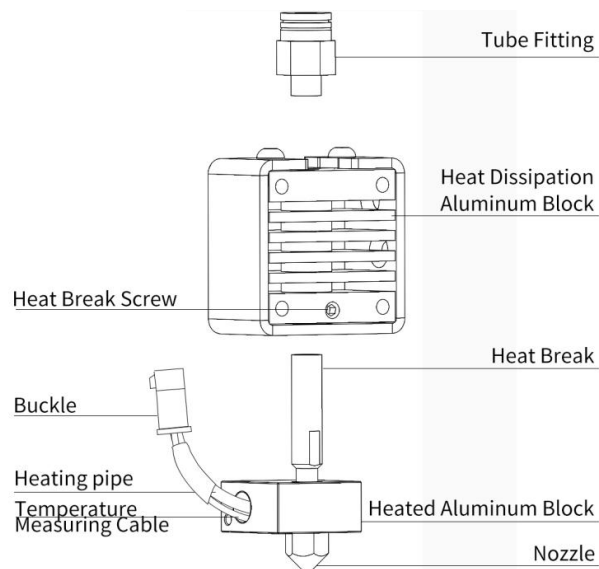

3. SYSTEM MENU

In the operation panel area on the top of the 3D printer, the left side is the TF card slot. The print data file is stored in the TF card. In the middle is an LCD screen, and on the right is a knob button. Press the knob button to open the system menu.

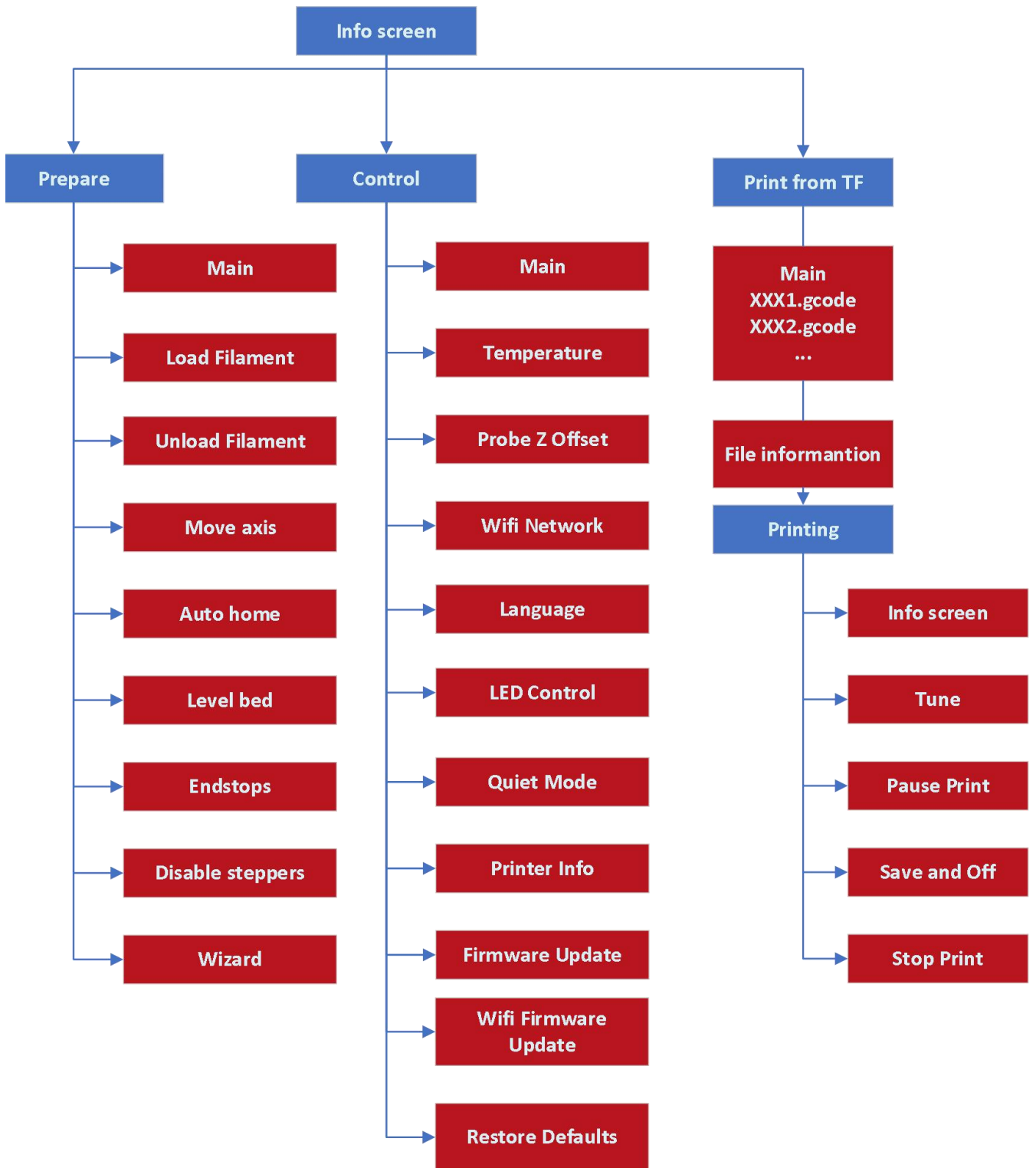

3.1. Basic Menu Control

- Turn the knob clockwise to move the highlight down on the menus or to decrease a value.
- Turn the knob counterclockwise to move the highlight up on the menus or to increase a value.
- Press the knob to enter the submenu, select the highlighted option, or accept the edited value.

3.2. Info Screen

After TINA2S starts up, the Info Screen is displayed.



Info Screen displays the status of the main components, including: Nozzle temperature (preset temperature and actual temperature), heated bed temperature (preset temperature and actual temperature), network connection status, XYZ position information, remaining printing time, and TF card status.

The bottom bar of the screen is the information bar, which displays the network status after power on. When the device is not connected to the Internet, it will display "OFF". After the device is connected to the WIFI network, it will display the IP address of the device.

Press the knob to open the main menu.

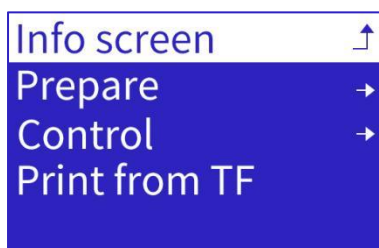

- Info Screen: Displays the info screen.
- Prepare: Displays the prepare menu.
- Control: Displays the control menu.
- Print From SD: Displays the list of TF card files.

3.3. Prepare Menu



Press the knob to open the prepare menu. This menu has two screens, turn the knob to scroll the screen.



3.3.1. Load Filament

Automatically heats the nozzle and loads the filament.

Click the button to enter the automatic loading filament interface.



The nozzle will be heated to 210°C, then the extruder will feed the filament to the nozzle. During heating or extrusion, you can press the knob button to exit the current operation.

3.3.2. Unload Filament

Automatically heats the nozzle and unloads the filament.

Click the button to enter the automatic unloading filament interface.



The nozzle will be heated to 210°C, then the extruder will retract the filament from the nozzle. During heating or extrusion, you can press the knob button to exit the current operation.

3.3.3.Move Axis

Move axis can operate each stepper motor, which can be used to debug the 3D printer or troubleshoot. Click the button to enter the sub menu.



Click "Move axis", click the adjustment buttons of X, Y, Z, and control the movement of the X, Y, and Z motors respectively. The distances of X.Y.Z axis: 10mm, 1mm, 0.1mm respectively. The distance of the extruder motor: 10mm, 1mm, 0.1mm. In the debugging interface of each axis, the knob can control the bidirectional operation of the axis motor.

1.Turn the knob to control the movement of X motor.



2.Turn the knob to control the movement of Y motor.

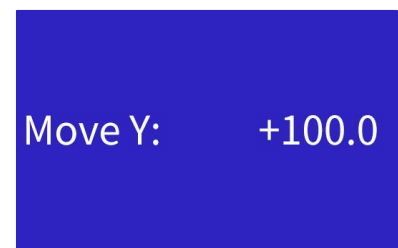

3.Turn the knob to control the movement of Z Motor.

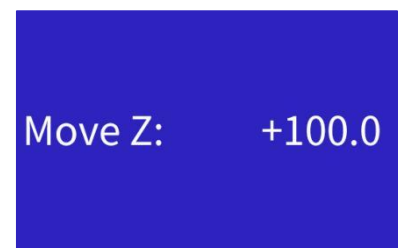
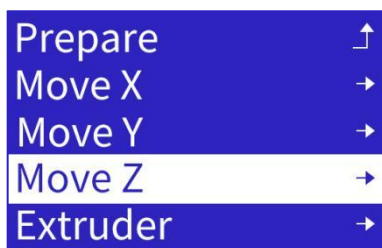

4.Turn the knob to control the movement of extrude motor.

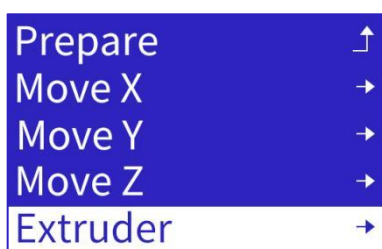

NOTICE:

1. THE MOVEMENT RANGE OF EACH MOTOR IS 0-100MM, PLEASE PERFORM" AUTO HOME" FIRST, AND THEN JOG TO ENSURE THAT THE 3D PRINTER OBTAINS THE CORRECT COORDINATES OF THE NOZZLE. IF" AUTO HOME" IS NOT PERFORMED, THE 3D PRINTER WILL SET THE CURRENT POSITION AS THE ORIGIN POSITION, RESULTING IN A SMALLER MOVEMENT RANGE OF THE JOG OPERATION.
2. THE MOVEMENT OF EACH MOTOR IS CONTROLLED BY THE ENDSTOP OF EACH AXIS. WHEN THE ENDSTOP IS TRIGGERED, THE MOTOR MOVEMENT STOPS IMMEDIATELY. NOTE THAT IF THE ENDSTOP IS BROKEN OR NOT WIRED PROPERLY, IT MAY GENERATE A NO-TRIGGER OR FALSE-TRIGGER SIGNAL, CAUSING THE MOTOR TO FAIL TO STOP OR MOVE.
3. THE EXTRUDER MOTOR HAS THERMAL PROTECTION FUNCTION, AND IT IS ONLY ALLOWED TO MOVE WHEN THE TEMPERATURE OF THE NOZZLE IS GREATER THAN 170°C.

3.3.4.Auto Home

Click then "Auto home", the XYZ axes will move respectively, the 3D printer nozzle and platform will automatically return to the origin, and the movement will stop after touching the each endstop.



This function can be used for troubleshooting. If the motor or endstop fails, this function will display a fault prompt.

3.3.5.Level Bed

Click "Level bed", the system will use the proximity sensor to do an Auto Bed Leveling operation. At the beginning of each print, system will always do the auto level bed operation, so that the nozzle and the platform maintain a proper distance during printing.



3.3.6.Endstop

Click on "Endstop" to display the status of XYZ endstops and proximity sensor. Move the nozzle or the platform to touch the endstops, and you can observe the change of the state of each endstop or the proximity sensor.

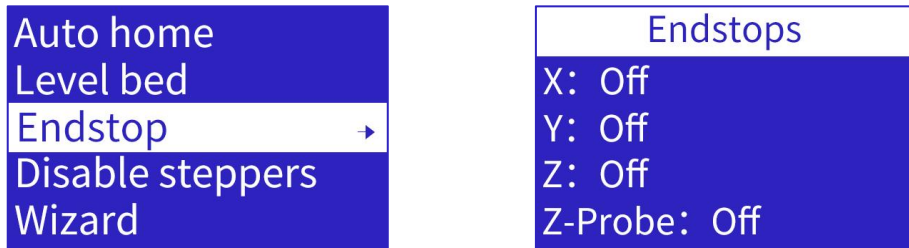

This function can be used for fault diagnosis of endstops and proximity sensor. If the endstop and proximity sensor fail, the state will not change.

3.3.7.Disable Steppers

“Disable steppers” will release the locked of the stepper motors. It is convenient to move the nozzle and platform by hand.



3.3.8.Wizard

Click " Wizard" to prompt the steps of printing TF card. This function is suitable for novice printing.

Select "Language" - "Step 1 Load Filament", heat the nozzle to the specified temperature - "Step 2 Insert TF card" - "Step 3 Print from TF card", select the file and start printing.



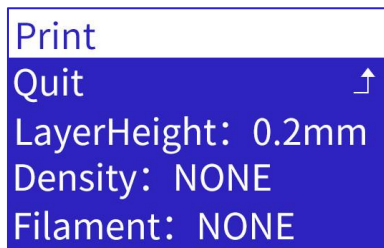
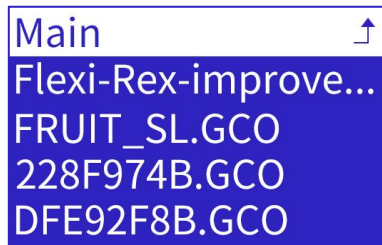

3.4. Control Menu



Press the knob to open the control menu. This menu has three screens, turn the knob to scroll the screen.



3.4.1. Temperature

Manually set the temperature of the nozzle or the heated bed.

Click "Temperature " to enter the page. Select the nozzle or heated bed to be heated, and click the button to confirm.



Turn the knob clockwise to reach the desired temperature, and press the knob to confirm. After the 3D printer starts to heat up, the home page will display the real time temperature of the nozzle.

If you want to perform other operations at this time, you can click the operation knob to return to the info screen, and the heating process will continue in the background. If you want to stop the 3D printer preheating, you can enter the preheating menu again, and turn the knob counterclockwise to zero.

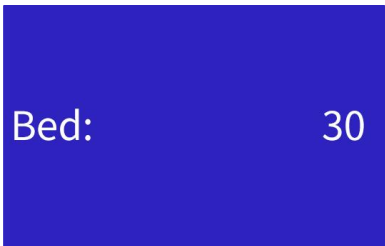
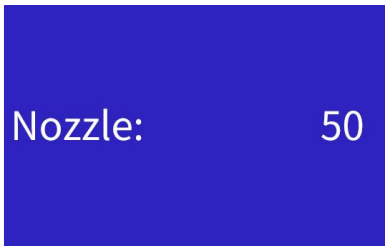

3.4.2. Prode Z Offset

After setting "Level bed", the gap between the nozzle and the platform needs to be set. If the gap is too small, the print head will scratch the platform or cause the nozzle be clogged. If the gap is too large, the printed model cannot stick to the platform well, and it is easy to cause the model to separate from the platform. It is recommended to recalibrate the Z offset after replacing the nozzle or proximity switch.

Click "Prode Z Offset" to enter the page.



Turn the knob, the nozzle will adjust the height of the printing position up and down. Press the knob to confirm and save.

3.4.3. WIFI Network



Press the knob to open the submenu.

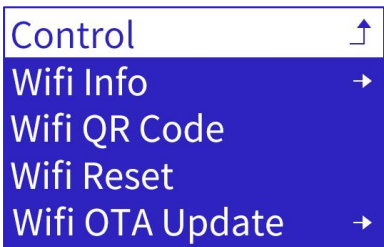

The network function of TINA2 has two connection modes, local mode, and remote mode.

Local mode: In the same local area network, Wiibuilder or Cura on the computer can connect to the 3D printer, and perform remote control or send print files. To use local mode, the 3D printer should be connected to the local WIFI network.

Remote mode: Use our APP, PoloPrint Pro, remotely control the 3D printer or download the print model. With the remote mode, you can remotely control the 3D printer from any location. To use remote mode, the 3D printer should be connected to the WIFI network and registered with the APP. Notice, a 3D printer can only be registered by one APP account.

3.4.3.1.WIFI Info

Click "WIFI Info" to open the WIFI info screen. It will show the WIFI firmware version, the serial, IP address, AP name, and the connection status of the cloud server. Only after registering in the APP, the 3D printer will connect to the cloud server.



3.4.3.2.WIFI QR Code

Click "WIFI QR Code" to show the QR code generated by the device serial. Used for App scanning networking and cloud access.

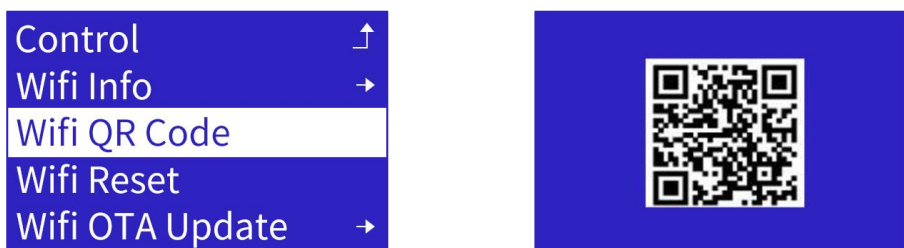

3.4.3.3.WIFI Reset

Every time TINA2 is turned on, it will automatically connect to the WIFI network that was successfully connected to the last time. If you need to connect TINA2 to a new WIFI network, you should execute the reset WIFI setting function to clear the saved WIFI network information.

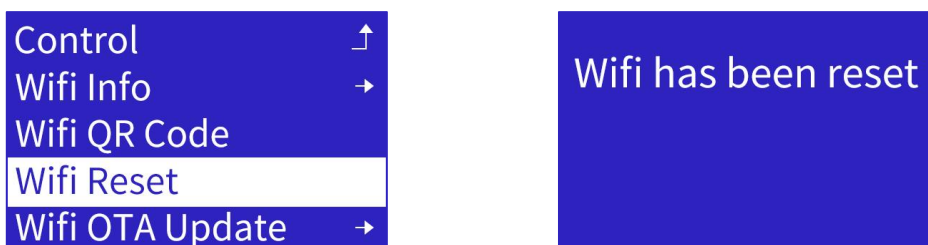

3.4.4. Language

Click "Language" to show the language list: Chinese, French, German, Italian, Japanese, Portugal, Dutch, and Turkish.

Turn the knob to choice the language you want to use, press the know to save and exit.



3.4.5. LED Control

Click "LED Control" to open the LED switch menu.

Press the knob to confirm and save.

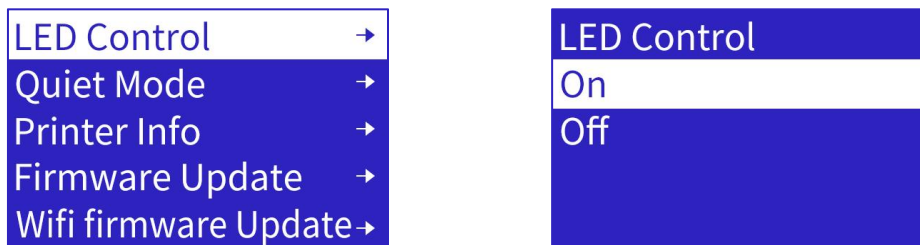

3.4.6. Quiet Mode

Click "Quiet Mode" to open the quiet mode switch menu. Quiet Mode significantly reduces the print speed to control the noise emitted.

Press the knob to confirm and save.

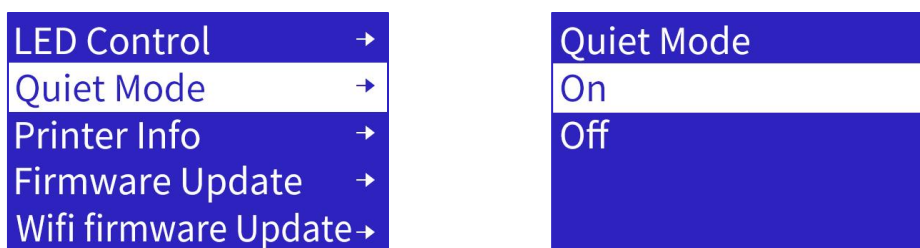

3.4.7. Printer Info

Click "Printer Info" to view the firmware version of the 3D printer.

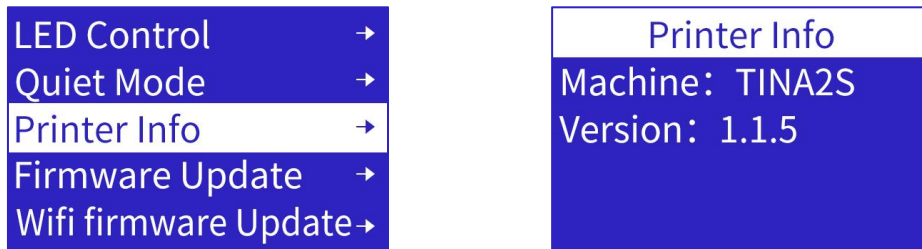

3.4.8. Firmware Update

1. Download and copy the motherboard firmware file to the root directory of the TF card. The suffix of the firmware file is wfm. If there is a compressed file, it should be decompressed first. Rename the firmware file to flash.wfm.

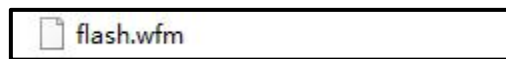

2. Insert the TF card into the 3D printer, and click "Firmware Update".
3. The 3D printer will check the version of the firmware file, and then update the motherboard firmware.

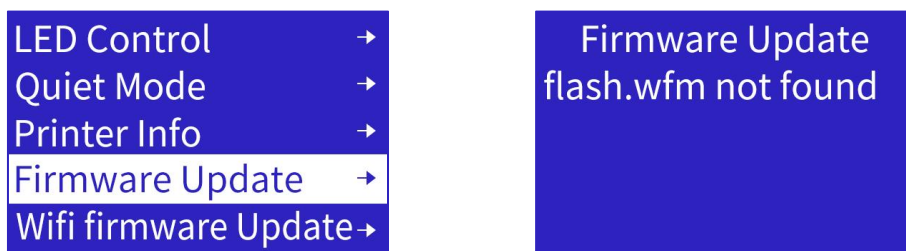

3.4.9. WIFI Firmware Update

1. Download and copy the Wifi firmware file to the root directory of the TF card. The suffix of the firmware file is efm. Rename the firmware file to wifi.efm.

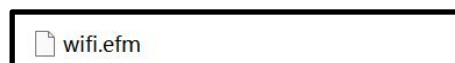

2. Insert the TF card into the 3D printer, and click "WIFI firmware Update" .
3. The 3D printer will check the version of the firmware file, and then update the Wifi firmware.



3.4.10.Restore Defaults

Click "Restore Defaults" to restore all parameters to the factory default.



3.5. Print from TF



Show the print data files in the TF card. The suffix of the print data file is gco or gcode.

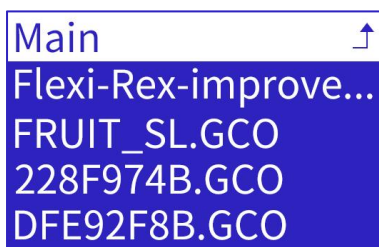

Select a file and press the knob. The next screen will show the printing information of the gcode file. Select "Print" will start printing. To prevent damage to the 3D printer, the system will check the machine model parameter in the gcode file. If the machine model parameter is not match or missing, the gcode file will not allowed to print. Please use the Wiibuilder or the customized version of Cura, select the correct model for slicing.

NOTE: THE LENGTH OF THE FILE NAME CANNOT EXCEED 20 CHARACTERS, OTHERWISE THE SYSTEM CANNOT RECOGNIZE IT OR DISPLAY GARBLED CHARACTERS.

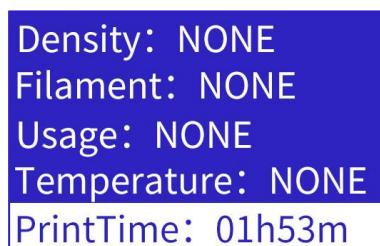
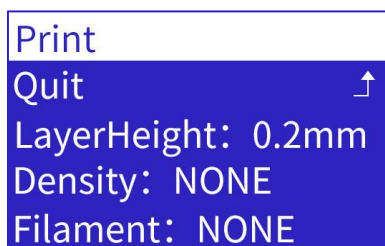

During the printing process, press the knob to open the printing setting menu.

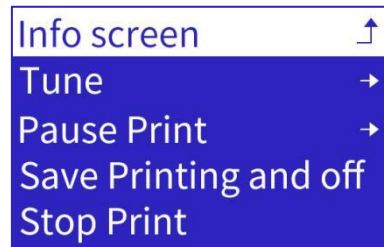

3.5.1. Tune

Select "Tune" to open the tune menu. You can adjust the print speed, nozzle temperature, heated bed temperature, extruder speed or Z offset during the printing process.

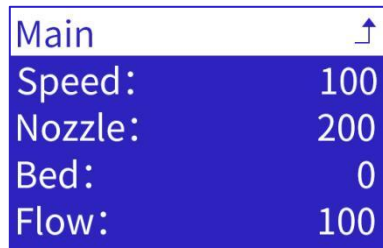
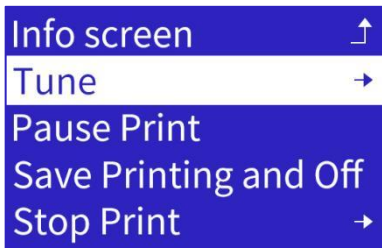

1. Select "Speed", turn the knob to reach the desired speed, and press the knob to confirm.

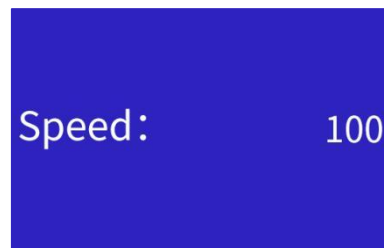
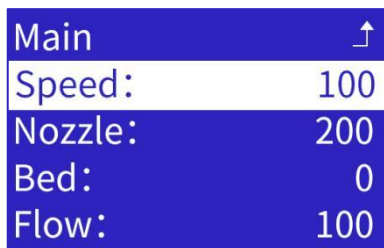

2. Select "Nozzle", turn the knob to reach the desired temperature of the nozzle, and press the knob to confirm.

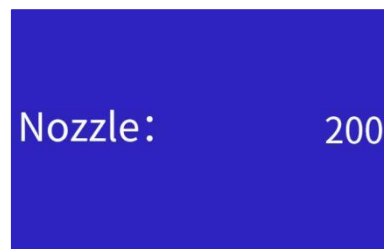
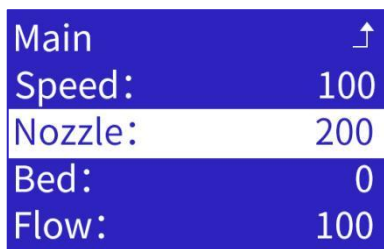

3. Select "Bed", turn the knob to reach the desired temperature of the heated bed, and press the knob to confirm.

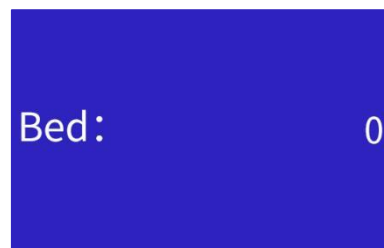
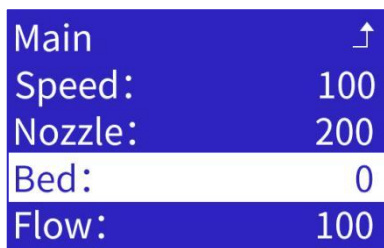

4. Select "Probe Z Offset", turn the knob to fine tune the gap between the nozzle and the heated bed, and press the knob to confirm.

THIS FUNCTION CAN ADJUST THE HEIGHT OF THE Z AXIS IN REAL TIME TO CHANGE THE GAP BETWEEN THE NOZZLE AND THE PLATFORM DURING THE PRINTING PROCESS. AT THE BEGINNING OF PRINTING, IF IT IS OBSERVED THAT THE GAP BETWEEN THE NOZZLE AND THE PLATFORM IS TOO SMALL AND THE NOZZLE DOES NOT PRODUCE SILK, THE Z OFFSET CAN BE INCREASED BY 0.2MM. IF IT IS OBSERVED THAT THE GAP BETWEEN THE NOZZLE AND THE PLATFORM IS TOO LARGE AND THE FILAMENT DOES NOT ADHERE WELL TO THE PLATFORM, THE Z OFFSET CAN BE GRADUALLY REDUCED.



3.5.2.Pause Print

Select "Pause Print", the 3D Printer will pause printing, and the nozzle will go to the pause position. In pause mode, you can replace the filament or resume the printing.

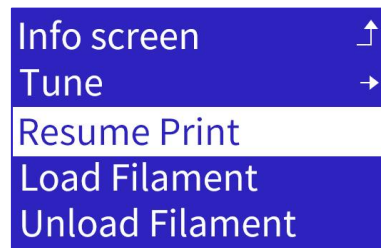

3.5.3.Save Printing and Off

Select "Save Printing and off", the 3D printer will save the current printing progress and go to the pause position. When the 3D printer stops moving, you can power off the 3D printer. The 3D printer will prompt whether to resume the printing when it is powered on next time.

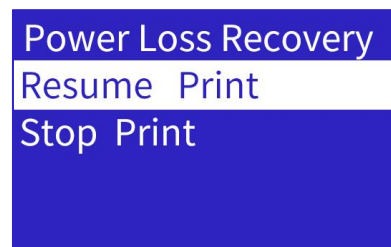
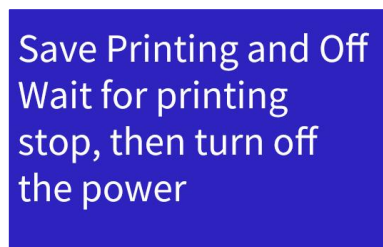

SPECIAL REMINDER:

WHEN “PAUSE PRINT” AND “SAVE PRINTING AND OFF”, THE 3D PRINTER PERFORMS A HOME OPERATION. DUE TO THE MECHANICAL NATURE OF ENDSTOP, THERE WILL BE SLIGHT DEVIATIONS FOR EACH HOMING OPERATION. THEREFORE, AFTER RESUMING PRINTING, THERE WILL BE A CERTAIN SEAM OR DEVIATION IN

THE POSITION WHERE THE PRINTING IS CONTINUED. THEREFORE, IT IS RECOMMENDED TO PRINT THE MODEL AT ONE TIME AS MUCH AS POSSIBLE.

3.5.4. Stop Print

Select "Stop Print", the 3D printer will cancel the current printing job and return to the Info screen.

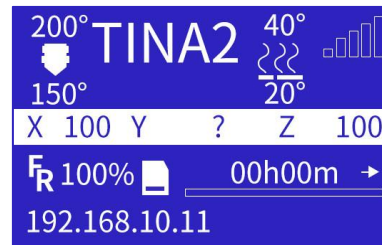

SPECIAL REMINDER:

AFTER PRINTING HAS STOPPED, REMOVE THE MODEL FROM THE PLATFORM.

4. COMMON MENU OPERATIONS

4.1. Load Filament



1. Open the main menu, then get into the prepare menu.
2. Turn the knob to the “Load Filament” and click. Once filament starts extruding from the nozzle.

4.2. Unload Filament



1. Open the main menu, the get into the prepare menu.
2. Turn the knob to the “Unload Filament” and click. The 3D printer will heat the nozzle and retract the filament.

4.3. Print from TF Card

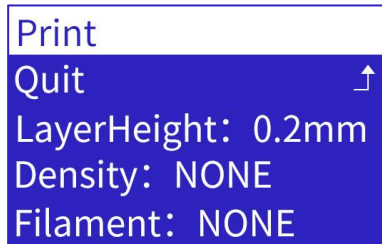

1. Open the main menu, turn the knob to the “Print From TF” and click to open the TF card file list menu.
2. Turn the knob to choose the file to print, then press the knob to start printing.

4.4. Common setting during printing

4.4.1. Pause Print

During the printing, press the knob to open the printing setting menu, choice the "Pause Print", the 3D printer will pause the printing and the nozzle will go to the pause position. Then, you can replace the filament, or resume the printing.

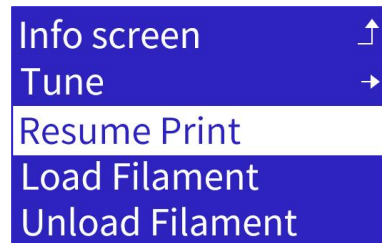

4.4.2. Modify Temperature

During the printing, press the knob to open the printing setting menu, get into the tune menu, choice the "Bed" to open then nozzle temperature adjustment function. Turn the knob to increase or decrease the temperature, press the knob to return.

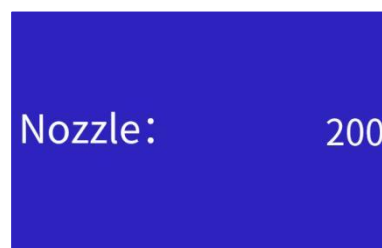
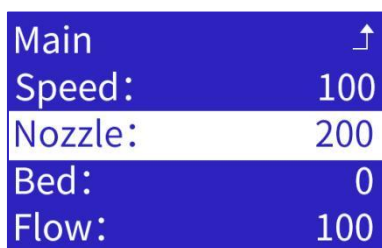

4.4.3. Modify Z Offset

I During the printing, press the knob to open the printing setting menu, get into the tune menu, choice then "Probe Z Offset" to open then Z offset adjustment function. Turn the knob to fine tune the gap between the nozzle and the platform.



Speed:	100
Nozzle:	200
Bed:	0
Flow:	100
Probe Z Offset	→

Adjust Z Offset(mm):
-1.360

THIS FUNCTION CAN ADJUST THE HEIGHT OF THE Z AXIS IN REAL TIME TO CHANGE THE GAP BETWEEN THE NOZZLE AND THE PLATFORM DURING THE PRINTING PROCESS. AT THE BEGINNING OF PRINTING, IF IT IS OBSERVED THAT THE GAP BETWEEN THE NOZZLE AND THE PLATFORM IS TOO SMALL AND THE NOZZLE DOES NOT PRODUCE SILK, THE Z OFFSET CAN BE INCREASED BY 0.2MM. IF IT IS OBSERVED THAT THE GAP BETWEEN THE NOZZLE AND THE PLATFORM IS TOO LARGE AND THE FILAMENT DOES NOT ADHERE WELL TO THE PLATFORM, THE Z OFFSET CAN BE GRADUALLY REDUCED.

4.5. Power On Resume Print

During printing, the 3D printer will save the current printing progress every 10s. If an unexpected power lost occurs, the 3D printer will prompt whether to resume the printing when it is powered on next time.

SPECIAL REMINDER:

WHEN PRINTING, THE 3D PRINTER WILL SAVE THE PRINTING PROGRESS EVERY 10S AND WRITE IT INTO THE ".BIN" FILE OF THE TF CARD. EACH TIME THE PROGRESS IS SAVED, THE PREVIOUS PROGRESS WILL BE DELETED. WHEN THE DEVICE IS POWERED OFF SUDDENLY AND RESTARTED, THE MACHINE WILL CHECK ONLINE WHETHER THERE IS A ".BIN" FILE IN THE MEMORY CARD. IF THERE IS, IT WILL PROMPT "CONTINUE PRINTING, STOP PRINTING"; CONTINUE PRINTING, THE DEVICE WILL READ THE SAVED PROGRESS AND STOP PRINTING, THE DEVICE WILL CLEAR THE ".BIN" FILE. HOWEVER, BECAUSE THE PROGRESS OF THE POWER OFF REPLAY IS SAVED ONCE EVERY 10S, AND THERE IS A TIME INTERVAL OF 10S, THERE IS A POSSIBILITY OF FAILURE IN THE POWER-OFF REPLAY.

5. WIFI NETWORK

There are two methods for TINA2S to connect the network, which will be described in detail below.

If you encounter problems , please consult the after-sales customer service.

5.1. File connect network

1. Use TF card reader to open TF card in a computer. Open the "WIFI.gcode" file, modify the string after the W300 command to be the WIFI network name, and modify the string after the W301 command to be the password of the WIFI network.

NOTE THAT THERE MUST BE A SPACE AFTER W300 AND W301, SAVE AND EXIT.

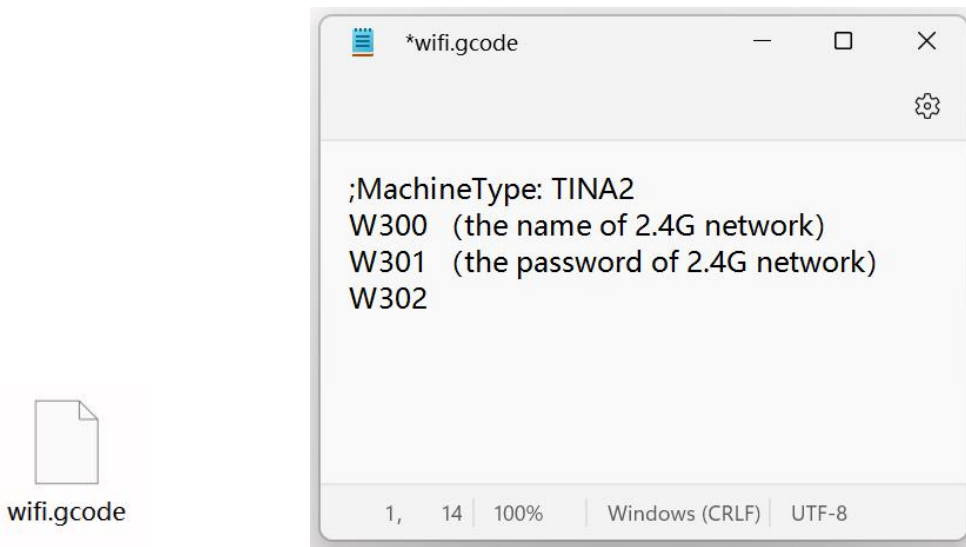

2. Insert the TF card into the TINA2 and choose to print the "WIFI.gcode" file. After few seconds, the info screen show the IP address, which means the network configuration is successful.



5.2. EspBluFi connect network

1. Download and install EspBluFi.

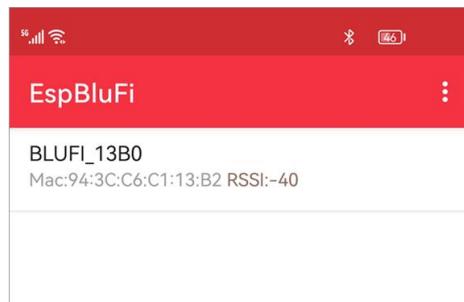

NOTE: TURN ON BLUETOOTH.

2. Open “Wifi Infor” , and get the last four digits of the SN.

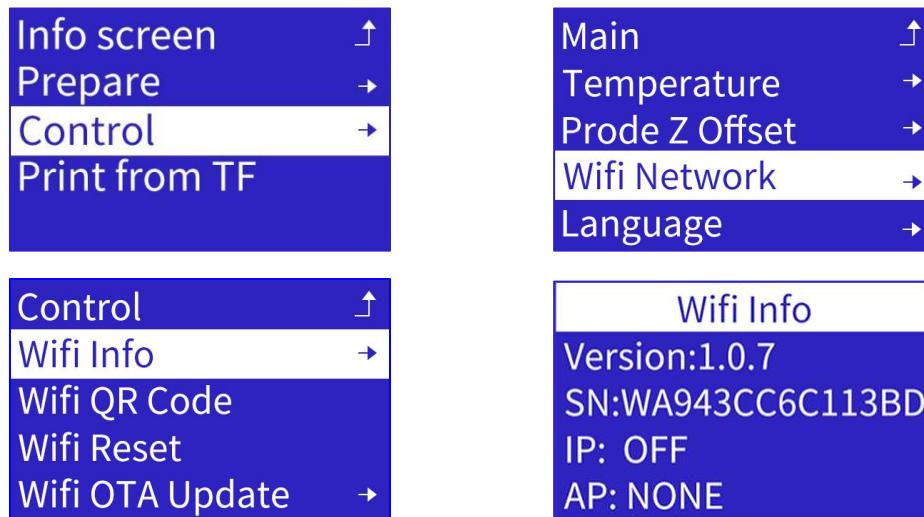

3. In EspBluFi, select the printer. Click "Connect", " Configuration".

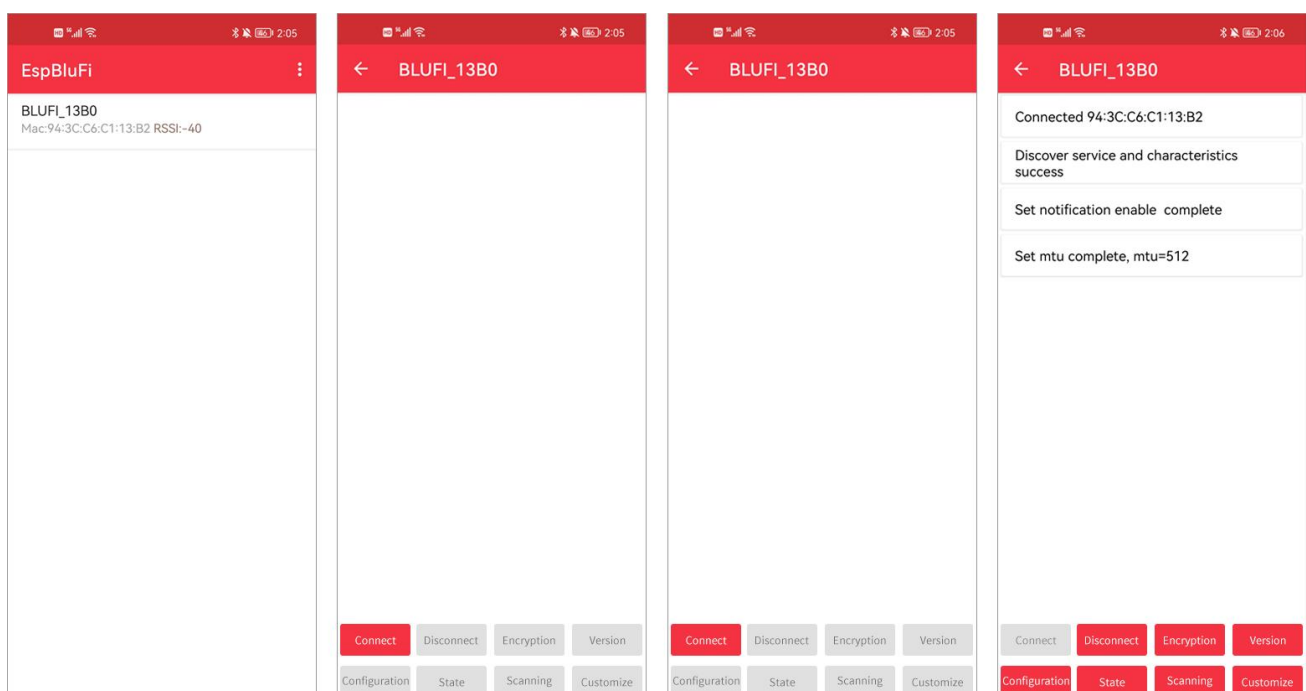

4. Click “  ”, select the 2.4G network , and enter the password.

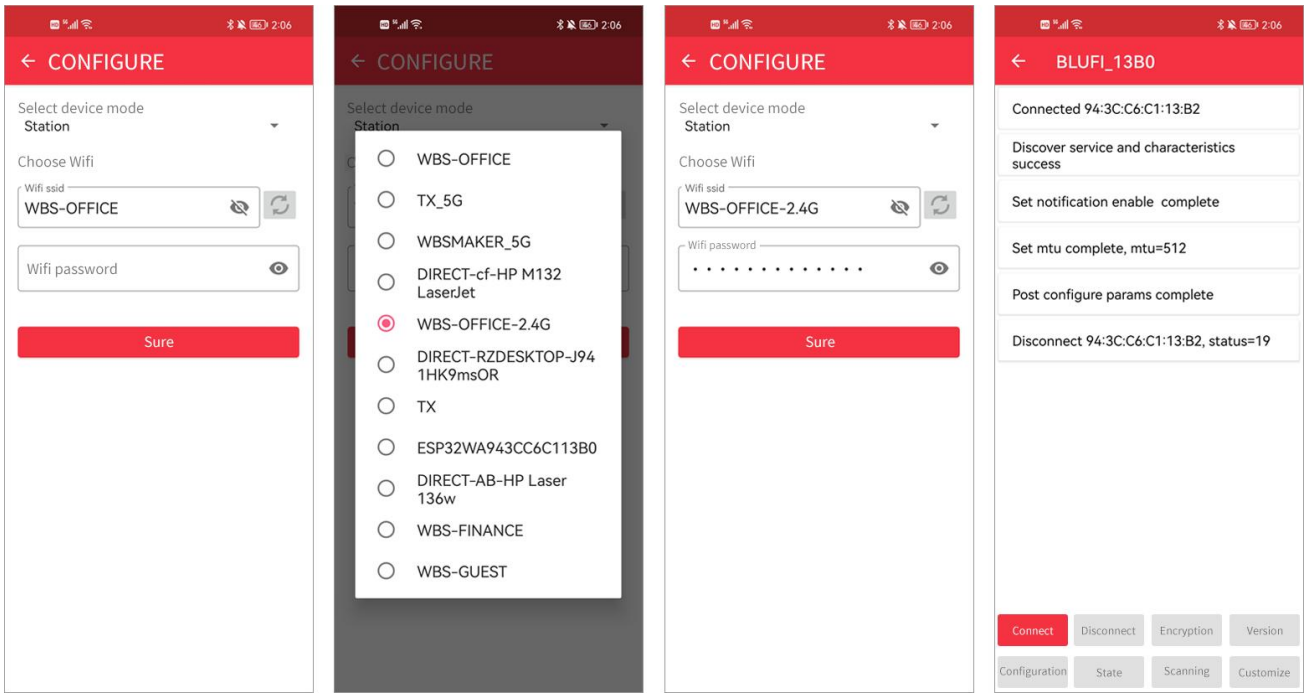

5. After restarting, if the machine displays IP address, the network configuration is successful.

```

Wifi Info
Version:1.0.7
SN:WA943CC6C11740
IP:192.168.10.250
AP:WBS-OFFICE-2.4G
    
```

```

200° TINA2 40°
150° 20°
X 100 Y ? Z 100
FR 100% 00h00m
192.168.10.11
    
```

6. WIIBUILDER SLICING SOFTWARE

The 3D printer includes the Wiibuilder slicing software on the included TF card. Use the included card reader to display the contents of the TF card on your PC to install the program.

Configuration requirements to run Wiibuilder:

- CPU: Pentium 1GHz
- Memory: minimum 1G
- Hard disk: more than 1G disk space
- Display resolution: minimum 640*480 pixels
- Graphics card: support 3D acceleration, support OpenGL2.0 and above
- Color: minimum 256 colors
- Operating system: Windows7 and above / MACOS8.0 and above
- Other runtime libraries: .Net Framework 4.5.2 and above

6.1. Installation

Perform the following steps to install the Wiibuilder slicing software.

Locate and run the Wiibuilder.exe software on the SD card to install the Wiibuilder software program. Click the Install-Next- Finishbutton to continue.

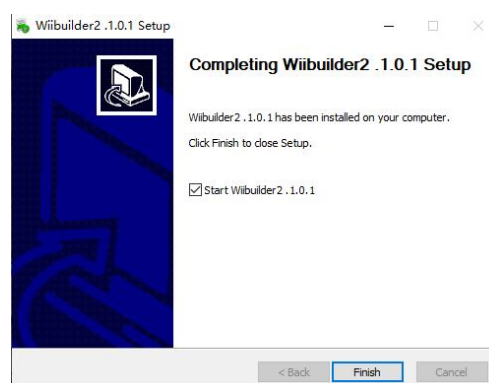
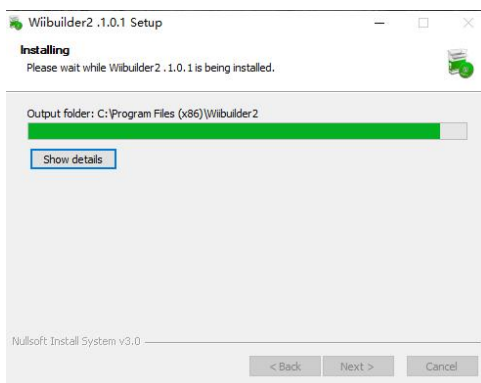
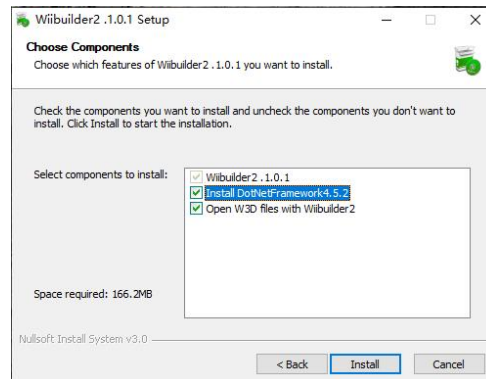
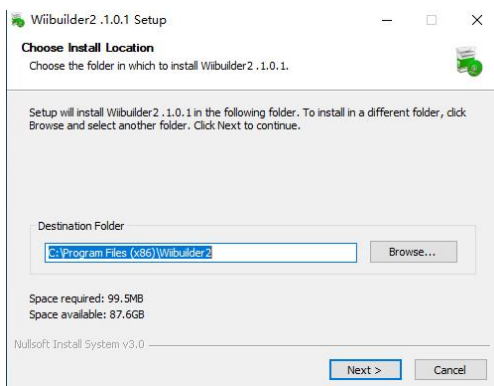

6.2. Interface Introduction

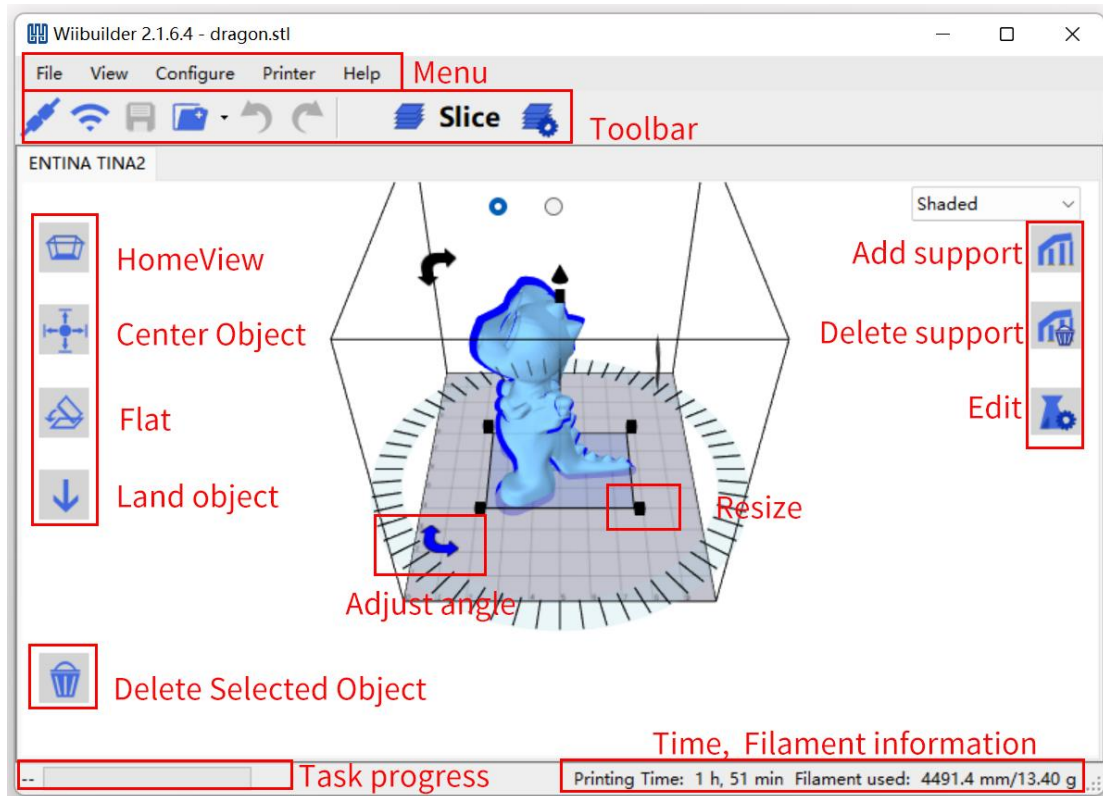

- Menu bar: Open the Wiibuilder menu.
- Toolbar: USB connection, WIFI connection, save gcode file, load model, undo, restore, execute slice, slice setting.
- Home view: Restore the default viewing angle.
- Center Object: Automatically adjust the XY coordinates of the model and place the model in the middle of the platform.
- Flat: Automatically adjust the inclination of the model, and flatten the inclined model on the platform.
- Land object: Automatically adjust the Z coordinate of the model to align the bottom of the model with the platform.
- Delete Selected Object: Delete the currently selected model.
- Add Support: Add manual support to the model.
- Delete Support: Delete the added manual support.
- Edit: Open model and Gcode editor.

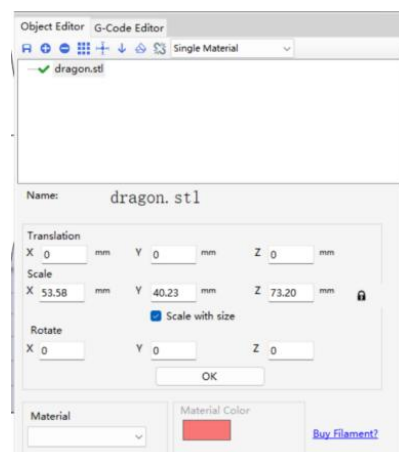

Right click on the model to open the context menu:

- Copy: Open the model copy.
- Mirror: Mirror the model according to the X, Y, Z axis directions.
- Delete: Delete the current model.
- Export: Export the current model to stl file.
- Arrange All Parts: automatically adjust the position and spacing of multiple models on the platform.
- Clear Plate: Delete all models on the platform.

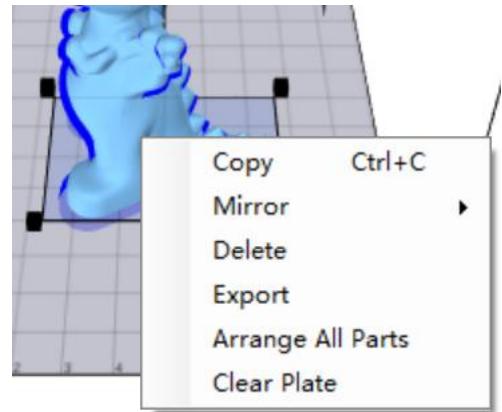

Slicing Settings:

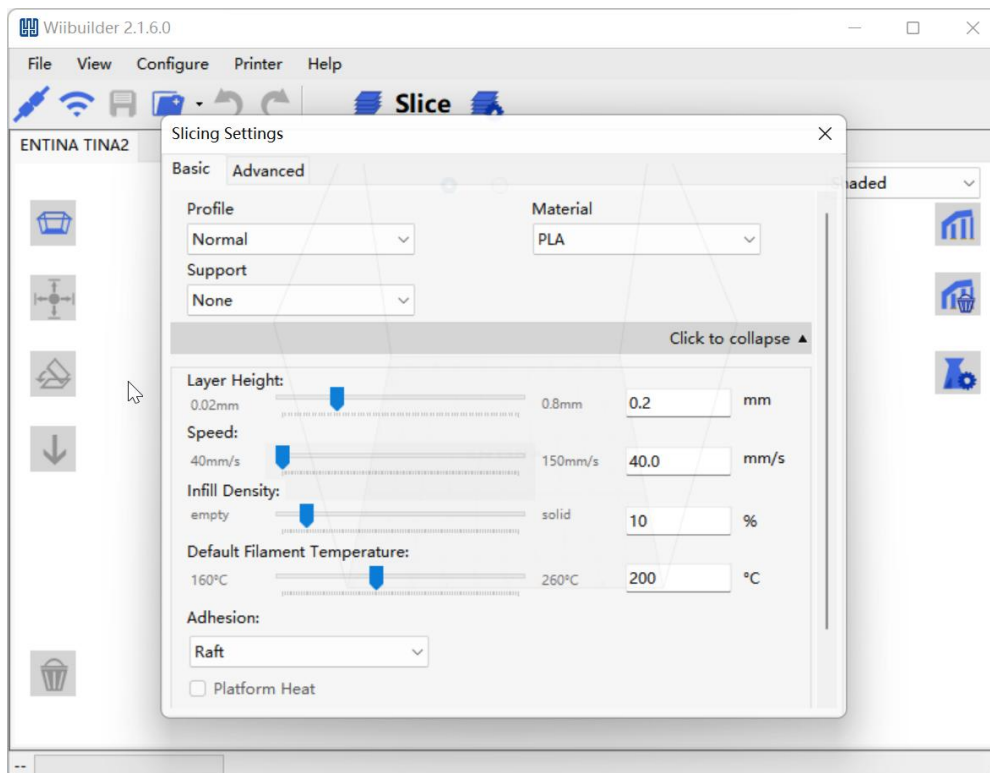

6.3. Add Model

1. Open Wiibuilder, click “File” to load the model, or just drag the model into it.

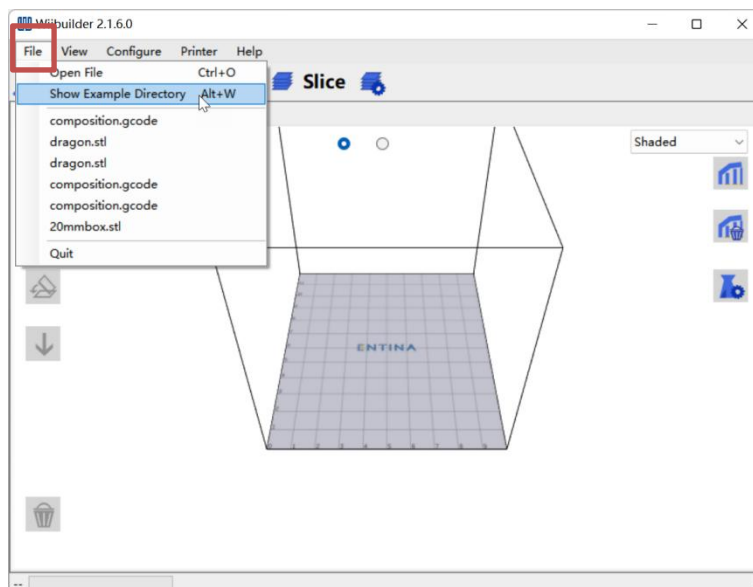

2. Five models have been stored in the “Show Example Directory”, you can use them for test printing.

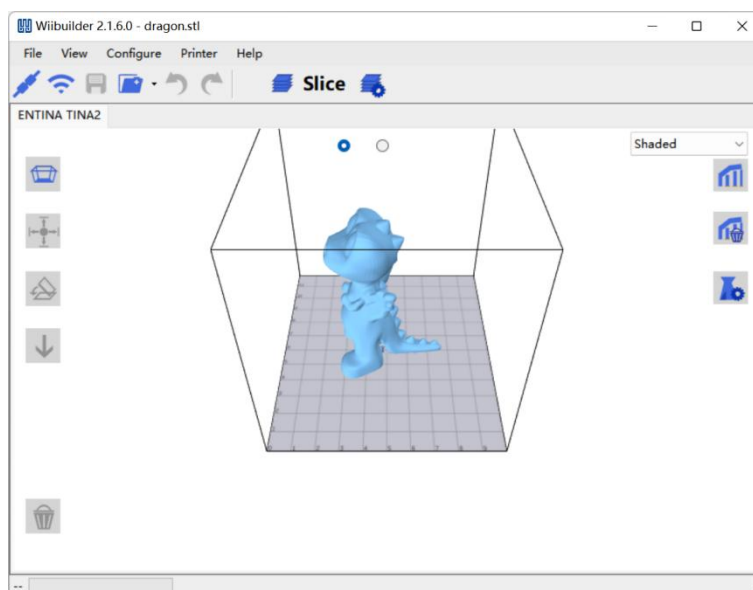

6.4. Adjust The Model

1. Click the model to adjust the size, angle, and position.

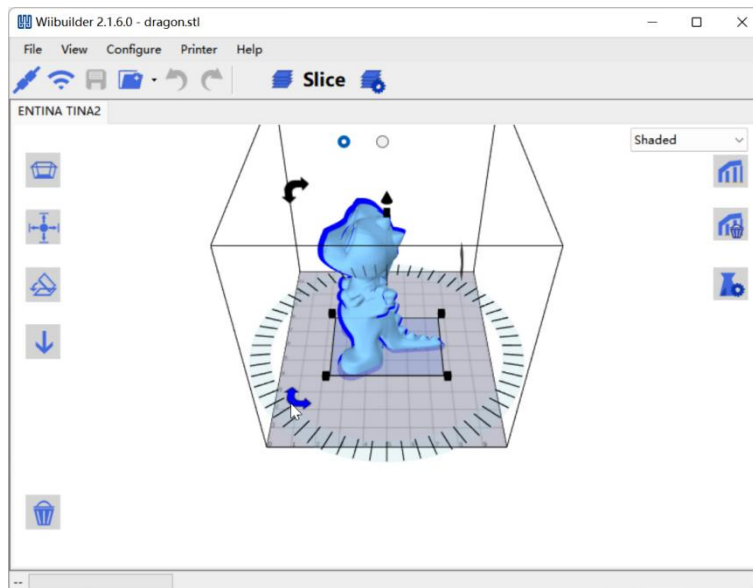

2. The model needs to be centered and correctly placed on the platform. Click "Center Object", "Flat", and "Land object".

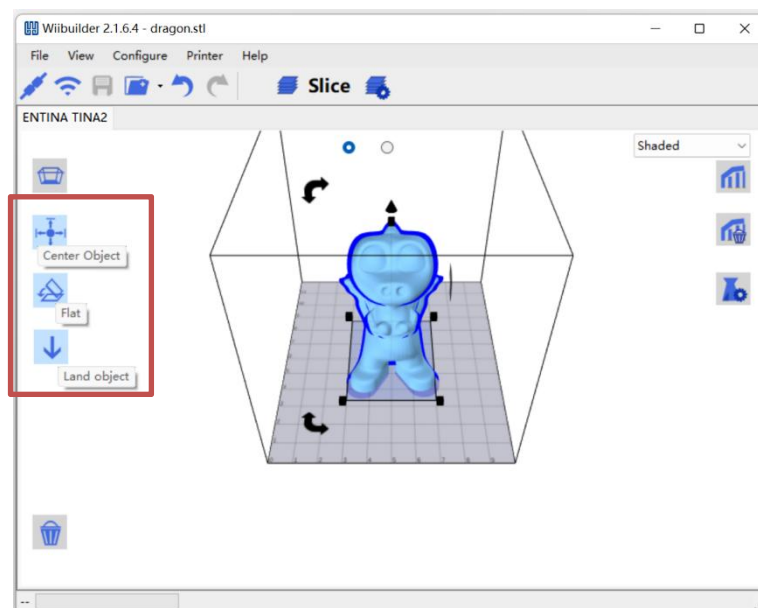

6.5. Basic Parameter Settings

Novice users can directly use the default parameters without adjustment.

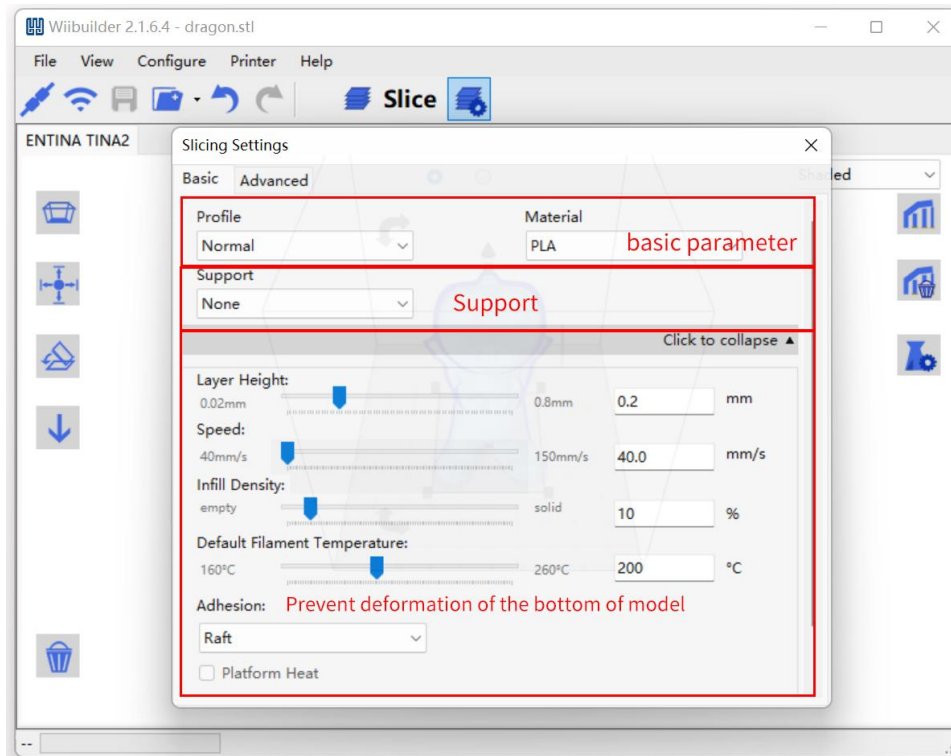

After setting the parameters, click "Slice" to convert the file.

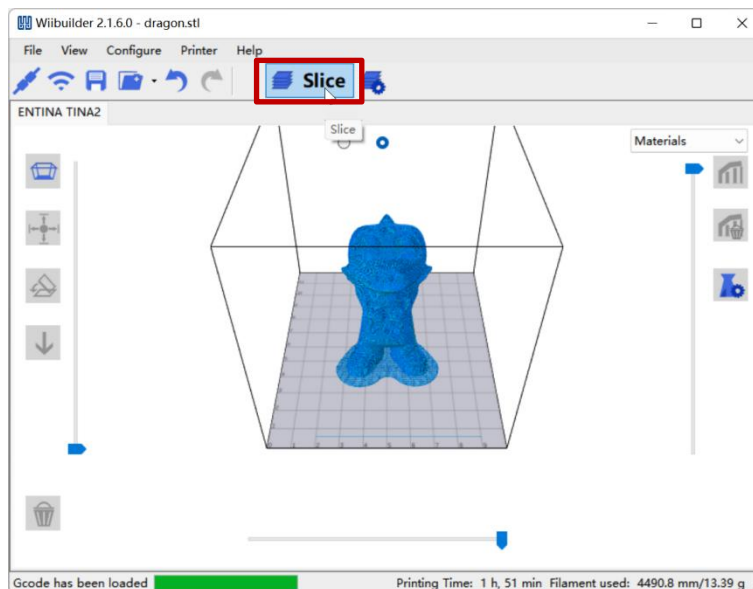

6.6. Send Files by The Network

NOTE: THE 3D PRINTER HAS BEEN CONNECTED TO THE NETWORK, AND THE IP ADDRESS IS DISPLAYED. FOR OPERATIONS, PLEASE REFER TO: "5. WIFI NETWORK".



1. The computer should connect to the same local network with the 3D printer.

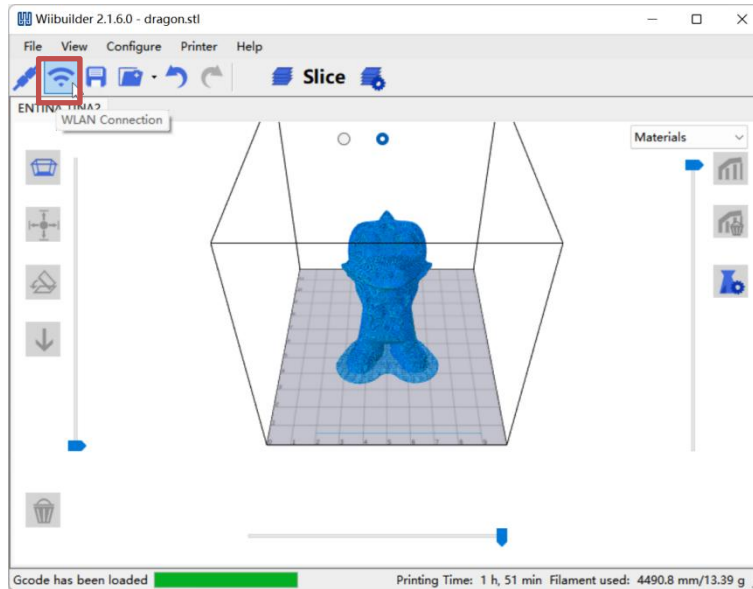

2. Click "WLAN Connection", the software will automatically search for the 3D printers in the local network and show them in the below list. If no 3D printer be found, you can also try to manually enter the IP address of the 3D printer to connect.

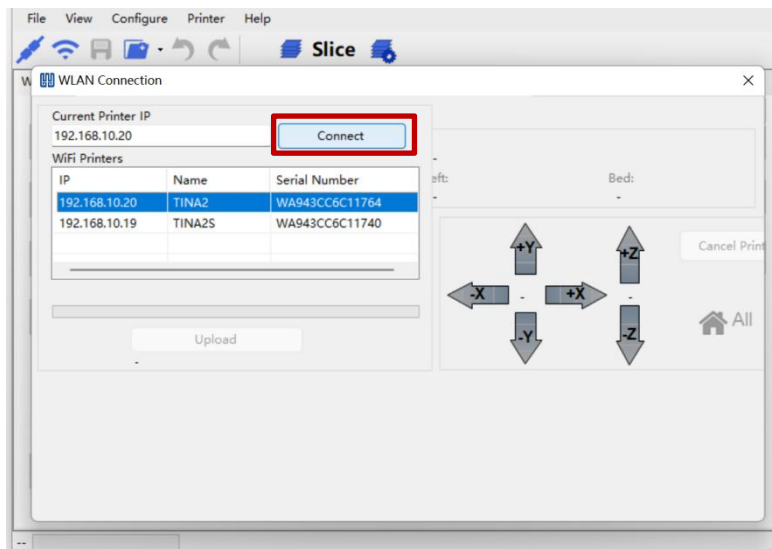

NOTE: IF YOU STILL CANNOT CONNECT TO THE 3D PRINTER, PLEASE CHECK WHETHER THE FIREWALL OF THE COMPUTER PROHIBITS THE SOFTWARE FROM NETWORKING, AND WHETHER THE COMPUTER AND THE 3D PRINTER ARE IN THE SAME LOCAL AREA NETWORK.

3. Send the sliced model to the 3D printer, and the 3D printer starts printing after receiving it.

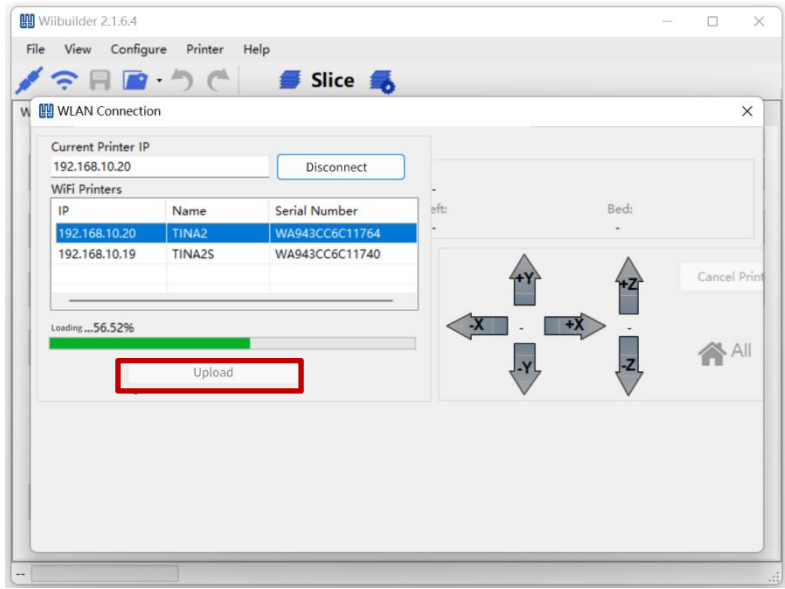

6.7. Send Files by TF Card

Save the sliced model to the TF card, insert the TF card into the 3D printer and print.

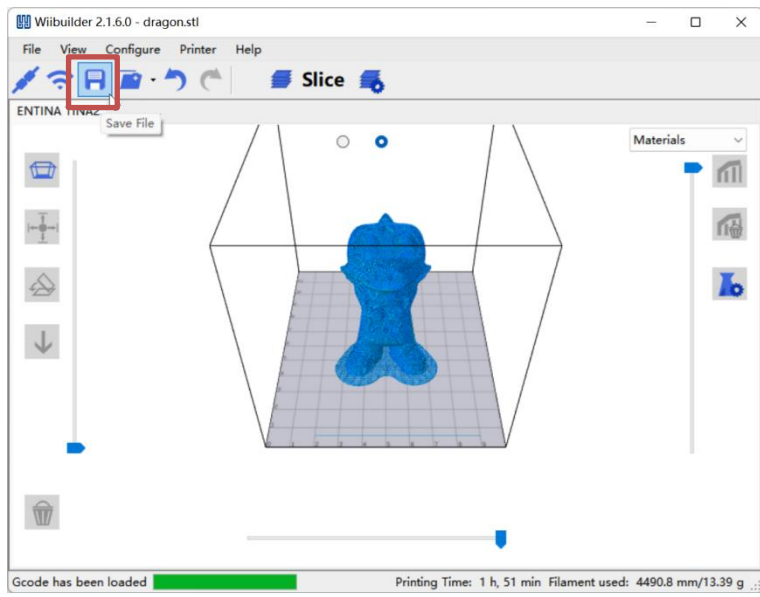

6.8. Send Files by USB

1. Connect the 3D printer and computer with a USB cable. The CH340 driver should be installed first. Click "Connect Printer".

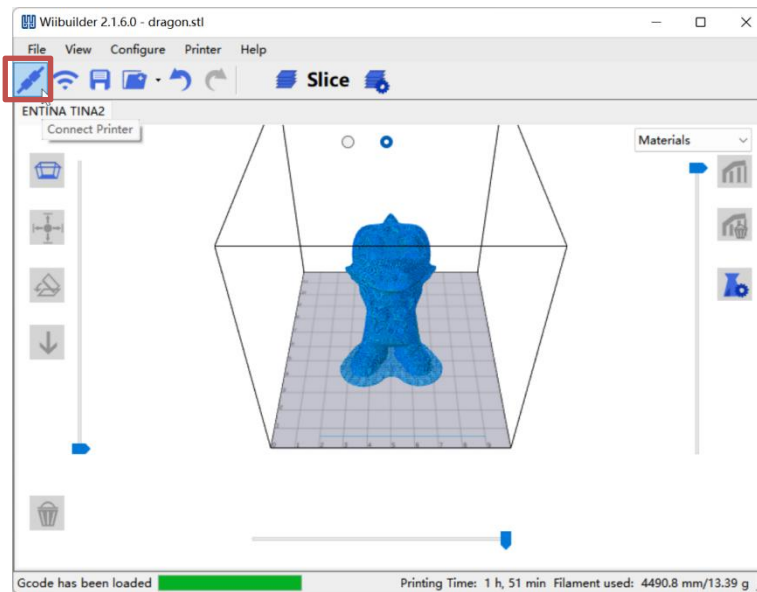

2. Click "Connect". Click "Upload And Print", the model will start printing.

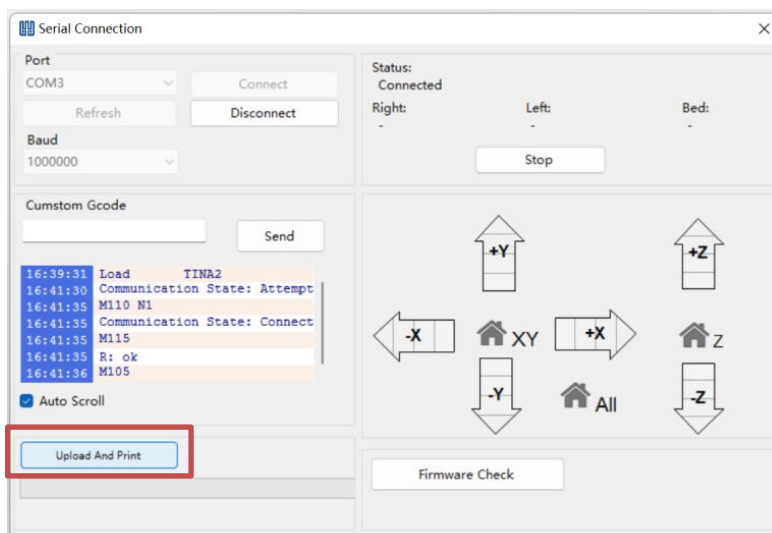
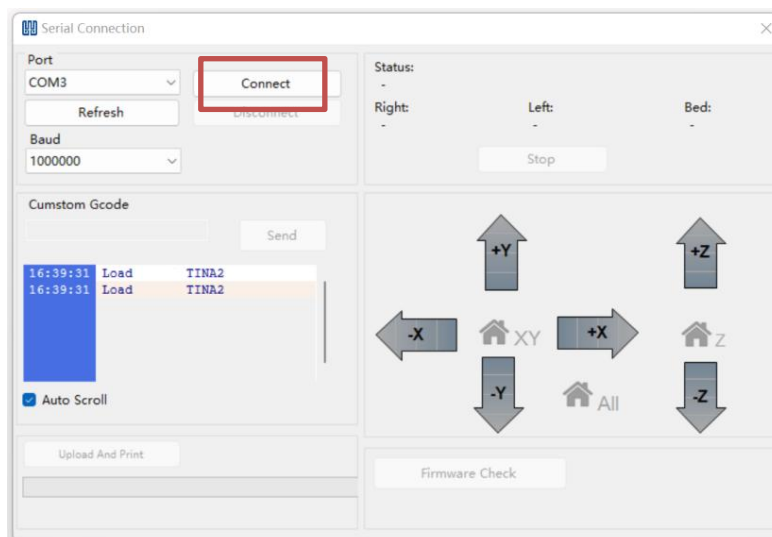

6.9. Advanced Parameter Settings

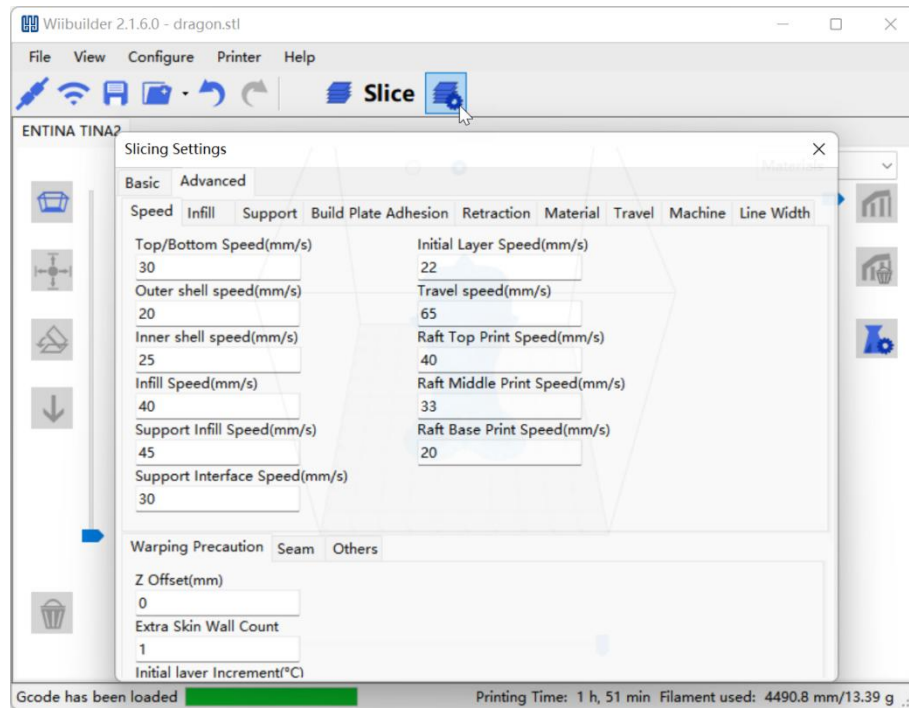

6.9.1.Speed Tab

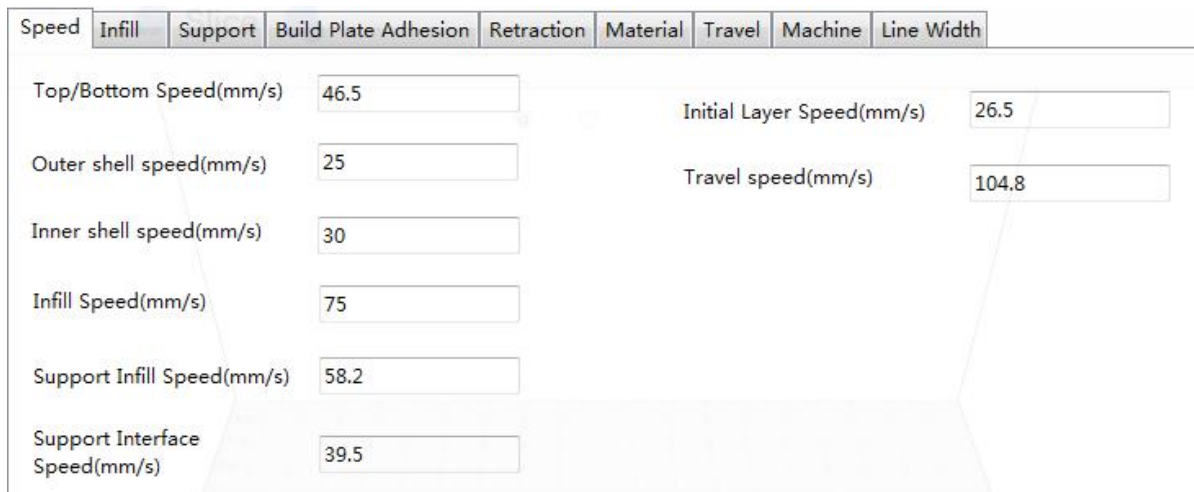

The **Speed Tab** features the following options:

- **Top/Bottom Speed (mm/s):** Sets the printing speed of the top and bottom surfaces of the model.
- **Outer shell speed (mm/s):** Sets the printing speed of the external shell surfaces.
- **Inner shell speed (mm/s):** Sets the printing speed of the internal shell surfaces.
- **Infill Speed (mm/s):** Sets the printing speed of the infill inside the model.
- **Support Infill Speed (mm/s):** Sets the printing speed of infill inside the model supports.
- **Support Interface Speed (mm/s):** Sets the printing speed of the top and bottom surfaces of the model supports.
- **Initial Layer Speed (mm/s):** Sets the printing speed of the first layer of the model.

- **Travel speed (mm/s):** Sets the movement speed of the nozzle when not printing.

6.9.2. Infill Tab

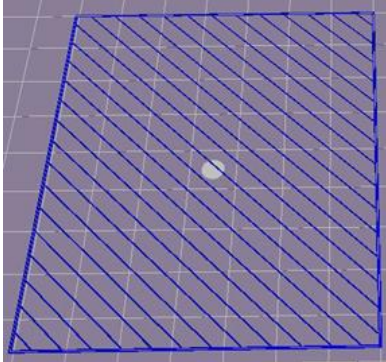
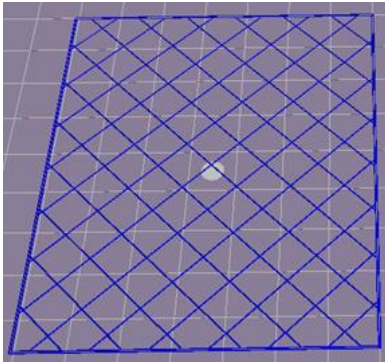
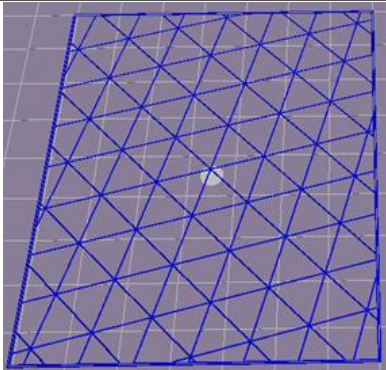
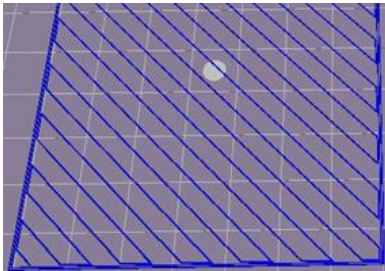

- **Infill Pattern:** Use the drop-down menu to select one of seven different infill patterns, including **Lines**, **Grid**, **Triangles**, **Zig Zag**, **Concentric**, **Cross**, and **Octet**. The individual patterns are illustrated in the table below.
- **Infill Before Wall:** Check this box to print the model after filling and printing the outline.
- **Outer Before Inner Walls:** Check this box to print the exterior walls before printing the interior walls.

Infill Patterns	
	
Lines	Grid
	
Triangle	Zig Zag

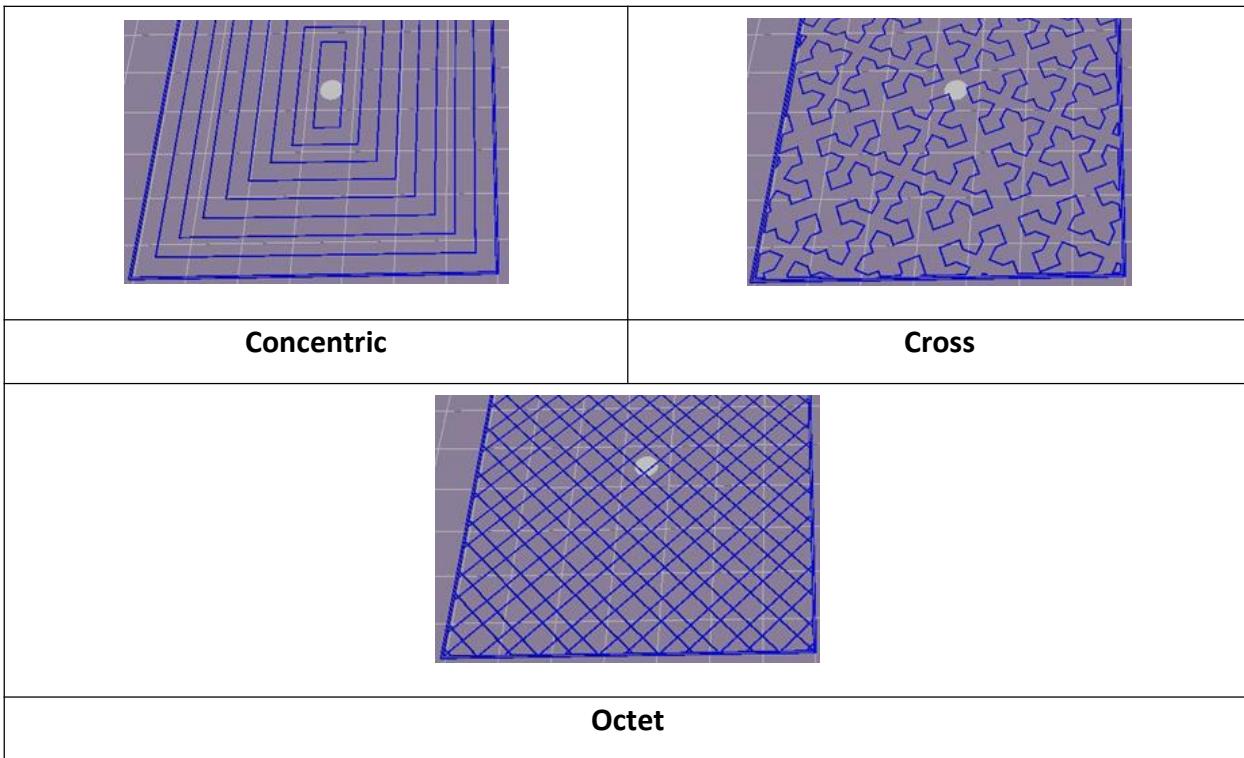

6.9.3.Support Tab

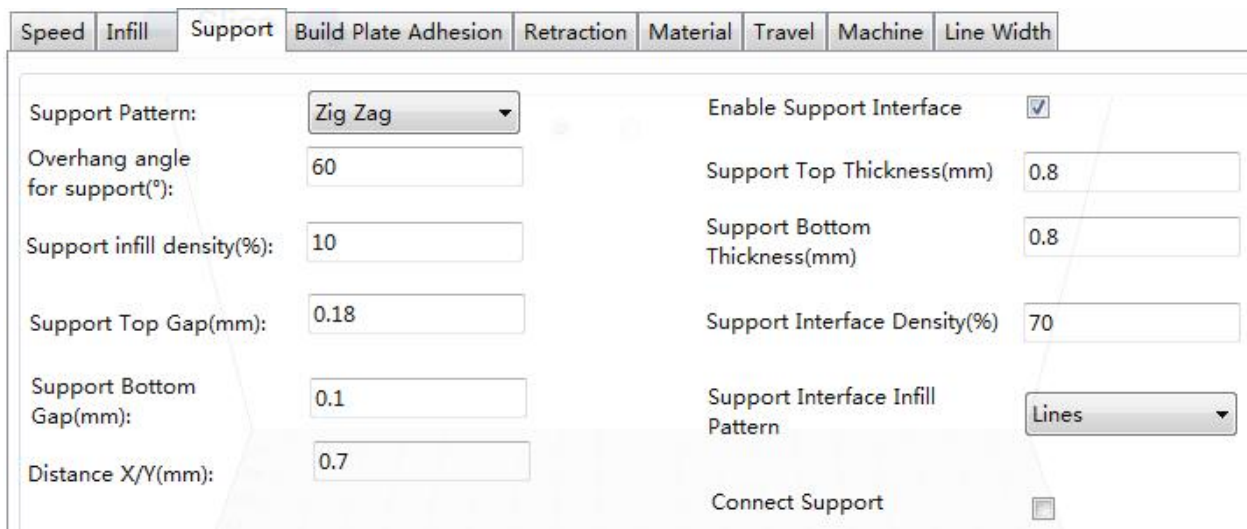

- **Support Pattern:** Use the drop-down menu to select one of five support patterns, including **Lines**, **Grid**, **Triangles**, **Zig Zag**, and **Concentric**. The pattern designs are the same as those of the infill patterns of the same name.
 - **Lines** support is easier to remove and is used on models that require more support.
 - **Grid** support is used on small models, which need fewer supports.
 - **Zig Zag** support is used for models that are particularly difficult to remove. It is stronger than Lines support and is better than Grid support.
- **Overhang angle:** The overhang angle is the angle between the support and the surface of the model. Larger settings make the supports easier to remove, while smaller settings provide better support. The default angle is 60 degrees.

- **Support infill density (%)**: Determines the infill density for supports. The higher the density, the stronger the supports.
- **Support Top Gap (mm)**: The distance between the top of the support and the model surface. The smaller the distance, the more effective the support, but is more difficult to remove from the model surface, resulting in residual material on the model surface. The larger the distance, the less effective the support, but is easier to remove from the model surface, resulting in a smoother surface.
- **Support Bottom Gap (mm)**: The distance between the bottom of the support and the model surface. The effects of this parameter are the same as the effects of the **Support Top Gap (mm)** parameter.
- **Distance X/Y (mm)**: The distance between the support and the model surface in the horizontal plane. The effects of this parameter are the same as the effects of the **Support Top Gap (mm)** parameter.
- **Enable Support**: Check this box to use supports.
- **Support Top**: Determines the thickness of the top layer of the supports.
- **Support Bottom**: Determines the thickness of the bottom layer of the supports.
- **Support Interface**: Sets the percentage of infill used inside the supports.
- **Support Interface Infill Pattern**: Use this drop-down menu to choose one of five infill patterns for the supports, including **Lines**, **Grid**, **Triangles**, **Zig Zag**, and **Concentric**. The pattern designs are the same as those of the infill patterns of the same name.
- **Connect Support**: Check this box to connect separate supports into one part.

6.9.4. Build Plate Adhesion Tab

Speed	Infill	Support	Build Plate Adhesion	Retraction	Material	Travel	Machine	Line Width
			Raft Air Gap(mm)	0.24		Brim line amount	20	
			Raft Extra Margin(mm)	5		Skirt Line Count	1	
			Raft Base thickness(mm)	0.3				
			Initial Layer Z Overlap	0.09				

- **Raft Air Gap (mm)**: The distance between the raft and the model. This determines the difficulty of removing the raft from the model.

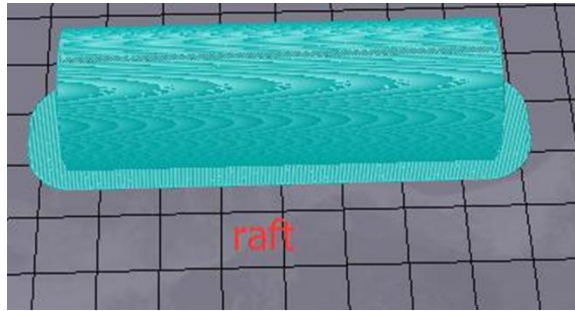

- **Raft Extra Margin (mm):** The distance between the edge of the raft and the model surface.
- **Raft Base thickness (mm):** Determines the thickness of the raft.
- **Initial Layer Z Overlap:** Determines the amount of overlap between the first and second layers of the model.
- **Brim line amount:** Sets the number of ring gaskets that are added to the edge of the model in contact with the build platform.

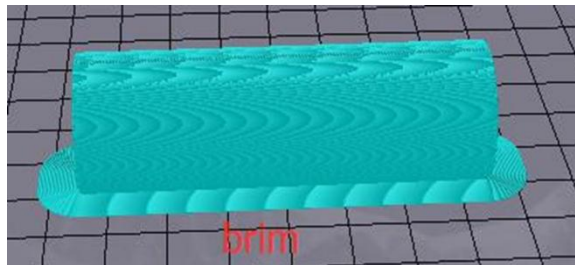

- **Skirt Line Count:** Sets the number of anti-overflow lines at the end of the model in contact with the build platform.

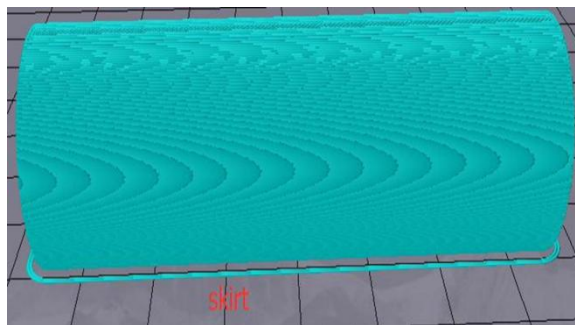

6.9.5. Retraction Tab

Speed	Infill	Support	Build Plate Adhesion	Retraction	Material	Travel	Machine	Line Width
Horizontal Travel Retraction		<input checked="" type="checkbox"/>		Z Hop When Retracted		<input checked="" type="checkbox"/>		
Retract at Layer Change		<input type="checkbox"/>		Z Hop Height(mm):		<input type="text" value="0"/>		
Retraction speed(mm/s):		<input type="text" value="28"/>						
Retraction distance(mm):		<input type="text" value="1.2"/>						
Retraction Minimum Travel(mm):		<input type="text" value="0.8"/>						

- **Horizontal Travel Retraction:** Check this box to enable filament retraction when the nozzle is not printing and is moving in a horizontal direction.
- **Retract at Layer Change:** Check this box to retract the filament when switching from layer to layer.
- **Retraction speed (mm/s):** Sets the speed at which filament is retracted.
- **Retraction distance (mm):** The distance the filament is retracted within the nozzle.
- **Retraction Minimum Travel (mm):** Sets the minimum nozzle movement distance before printing and before retracting the filament.
- **Z Hoe When Retracted:** Check this box to enable lift the nozzle when filament is returned after retraction.
- **Z Hop Height (mm):** The distance the nozzle is lifted when filament is returned after retraction.

6.9.6. Material Tab

The screenshot shows a software interface with several tabs: Speed, Infill, Support, Build Plate Adhesion, Retraction, Material, Travel, Machine, and Line Width. The 'Material' tab is active. It contains two input fields: 'Filament flow(%)' with a value of 95, and 'Filament Diameter(mm)' with a value of 1.75.

- **Filament flow (%):** Sets the flow rate of filament in the melting state. This is set according to the type of filament being used. In general, the flow rate for PLA or PLA Pro is 90 and the flow rate of ABS is 100.
- **Filament Diameter (mm):** Sets the diameter of the filament being used. This printer only supports 1.75mm diameter filament.

6.9.7. Travel Tab

The screenshot shows a software interface with tabs: Basic, Advanced, Speed, Infill, Support, Build Plate Adhesion, Retraction, Material, Travel, Machine, and Line Width. The 'Travel' tab is active. It contains a dropdown menu for 'Combing Mode' which is currently set to 'Off'.

- **Combing Mode:** This option determines how the nozzle will move when not printing. The **Off** option has the nozzle move the shortest distance between the previous extrusion location and the new start location. The **All** option causes the nozzle to move along anything it has already extruded. The **No Skin** option will avoid the outer layers to move the nozzle to the new start location, which can greatly improve print quality.

6.9.8. Machine Tab

Basic	Advanced
Speed	Infill
Support	Build Plate Adhesion
Retraction	Material
Travel	Machine
Line Width	
Right Nozzle Diameter(mm)	
<input type="text" value="0.4"/>	

- **Right Nozzle Diameter (mm):** Sets the diameter of the nozzle on the right extruder. This printer only has a single extruder, which is designated the right extruder. The nozzle diameter of this printer is 0.4mm.

6.9.9. Line Width Tab

Speed	Infill	Support	Build Plate Adhesion	Retraction	Material	Travel	Machine	Line Width
Outer Wall Line Width(mm)	<input type="text" value="0.4"/>	Skirt/Brim Line Width(mm)	<input type="text" value="0.4"/>					
Inner Wall(s) Line Width(mm)	<input type="text" value="0.4"/>	Raft Top Line Width(mm)	<input type="text" value="0.4"/>					
Top/Bottom Line Width(mm)	<input type="text" value="0.4"/>	Raft Middle Line Width(mm)	<input type="text" value="0.7"/>					
Infill Line Width(mm)	<input type="text" value="0.5"/>	Raft Base Line Width(mm)	<input type="text" value="0.8"/>					
Support Line Width(mm)	<input type="text" value="0.4"/>	Prime Tower Line Width(mm)	<input type="text" value="0.4"/>					

- **Outer Wall Line Width (mm):** This is the width of the outermost wall line. By lowering this value, higher levels of detail can be printed.
- **Inner Wall(s) Line Width (mm):** This is the width of a single wall line for all walls except the outermost wall.
- **Top/Bottom Line Width (mm):** This is the width of the top and bottom lines.
- **Infill Line Width (mm):** This is the width of a single infill line.
- **Support Line Width (mm):** This is the width of a single support structure line.
- **Skirt/Brim Line Width (mm):** This is the width of a single skirt or brim line.
- **Raft Top Line Width (mm):** This is the width of the lines in the top surface of the raft. These lines can be thin so that the top of the raft is smooth.
- **Raft Middle Line Width (mm):** This is the width of the lines in the middle raft layers. Making the second layer extrude more causes the lines to stick to the build plate.
- **Raft Base Line Width (mm):** This is the width of the raft base layer. These should be thick lines to assist with build plate adhesion.
- **Prime Tower Line Width (mm):** This is the extrusion width of the prime tower.

6.9.10. Seam Tab

Note: The Z Seam is where the 3D printer finishes its motion when printing the skin (outside layer) of a model. This can result in a small blob or zit where the 3D printer changes the Z height. If in alignment, there can be a noticeable line up the side of the print, referred to as a Z Seam, because the filament continues to ooze at the start/stop location. The options on this screen are used to mitigate this effect.

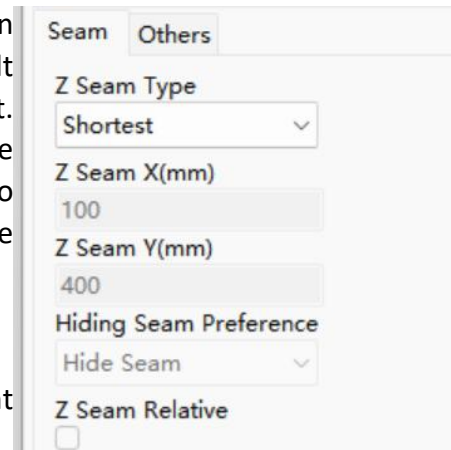

- **Z Seam Type:** Determines where the Z Seam will appear.
 - **Shortest:** This option selects the most time efficient start/stop location.
 - **User Specified:** This option allows you to specify the X and Y start/stop location, which determines where the Z Seam will appear.
 - **Random:** With this option, the 3D printer will randomly choose the start/stop location, which prevents building a column.
 - **Sharpest Corner:** The start/stop location and the Z Seam will appear in the sharpest corner of the model.
- **Z Seam X (mm):** This option is the X location of the Z Seam. This option can only be set when the Z Seam Type is set to **User Defined**.
- **Z Seam Y (mm):** This option is the Y location of the Z Seam. This option can only be set when the Z Seam Type is set to **User Defined**.
- **Hiding Seam Preference:** This option is only available when the Z Seam Type is set to **Sharpest Corner**. It determines whether the Z Seam will be on the inside or outside of the corner.
- **Z Seam Relative:** Checking this box will set the Z Seam in respect to the object's center, whereas leaving the box unchecked will set the Z Seam along the absolute position on the build plate. This option is only available when the Z Seam Type is set to **User Defined**.

6.9.11. Others Tab



- **Skin Layers Thickness (mm):** This option determines the thickness of the top and bottom skin layers.

- **Horizontal Expansion (mm):** Thermoplastics tend to shrink when cooling. This option allows you to fine tune the part size to offset shrinkage for prints that require tighter tolerances.
- **Skin Alternate Rotation:** Typically, a 3D printer will print solid layers for the top and bottom layers. When doing this, it changes direction 90 degrees from layer to layer. This setting changes that behavior to add an additional 45 degrees of rotation every two layers.

The following images illustrate the normal print direction of the first three layers.



The following image illustrates the print direction of layer three when the **Skin Alternate Rotation** option is enabled.



- **Enable Print Cooling:** When enabled, cooling air will be directed at the printed part.
- **Enable Draft Shield:** When enabled, this printer will print a wall around the model to prevent environmental breezes or drafts from affecting the cooling. This is typically used when **Enable Print Cooling** is disabled for filament that needs a longer cooling time, such as ABS.
- **Wall Line Count:** This option determines the number of walls to print.

7. PRINT BY APP

1. Download and install the APP : PoloPrint Pro
2. Register or log in to the APP.
3. Get the “ Wifi QR Code ”.

NOTE: THE 3D PRINTER HAS BEEN CONNECTED TO THE NETWORK, AND THE IP ADDRESS IS DISPLAYED. FOR OPERATIONS, PLEASE REFER TO: "5. WIFI NETWORK".



4. Click "Printer", “ + ”, scan the QR code displayed on the screen, and submit the recognized SSID.

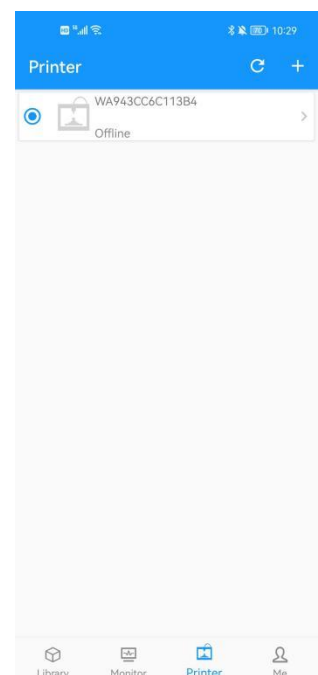
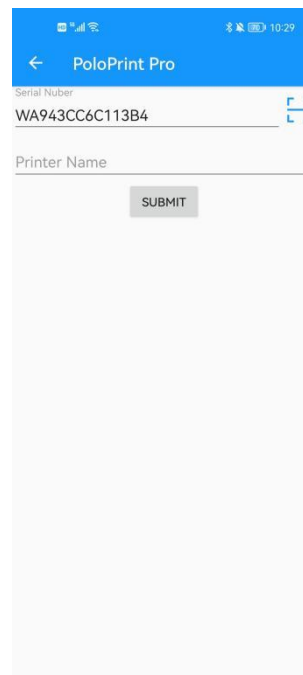
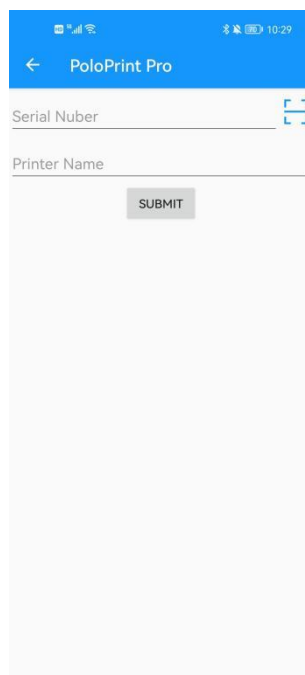
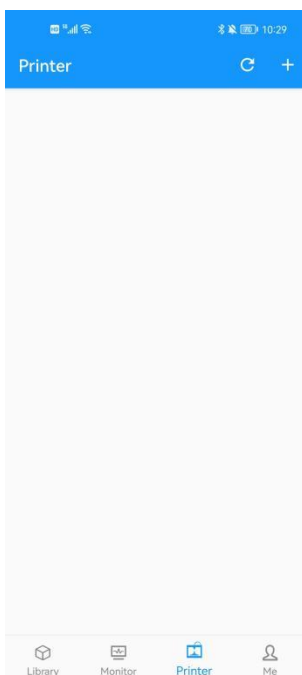

5. Select a model and click "Print".

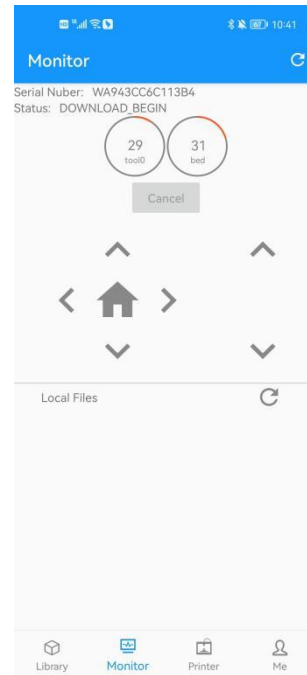
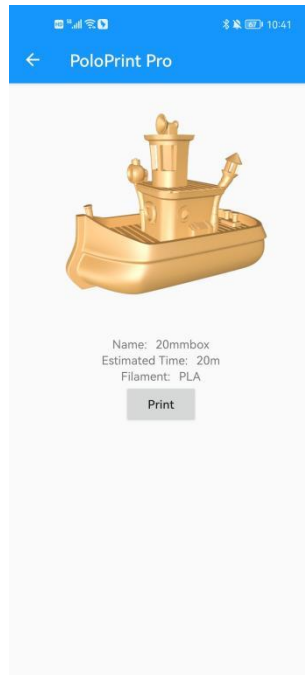
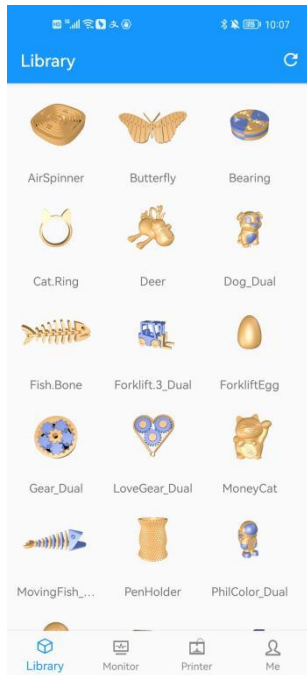

8. COMMON FAULTS

When you encounter hardware or operation problems, you can use the following operations to determine the fault, or you can solve the problem by consulting the “TROUBLESHOOTING” or contacting the after-sales service.

8.1. Filament Feeding Failure

If it is found that the extruder cannot load filament normally, and the extruder gear is still rotating, the extruder is blocked. Please clean the nozzle.

8.2. Printing Failure

If the 3D printer fails to work properly, perform the following operations for troubleshooting.

8.2.1. Perform the action: Print the file

(1) **Fault:** the temperature of the nozzle is displayed as: -14°C, or there is a failure prompt interface, as shown in the figure below:



Reason: The temperature measurement of the nozzle is faulty, or the cable falls off.

Solution: Replug or replace the temperature measurement cable of the nozzle, or plug in the cable.

(2) **Fault:** The failure prompt as shown in the figure appears:

Reason: The heating of the nozzle is faulty.

Solution: Replace the sprinkler assembly.



(3) **Fault:** Restart after 5 seconds, or display:

Reason: The file of the TF card is faulty.

Solution: Format the card.

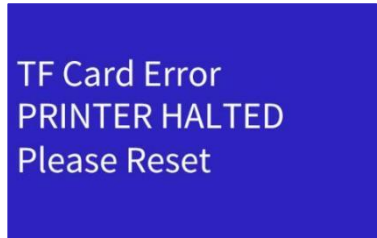

(4) **Fault:** As soon as the 3D printer is started, it will display whether to "continue printing".

Reason: The file of the TF card is faulty.

Solution: Format the TF card.

8.2.2. Perform the action: turn on the "Endstop" function

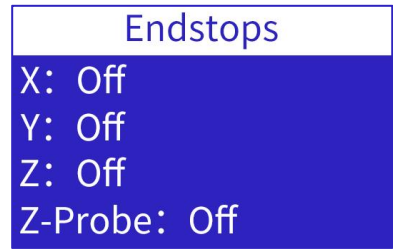

Fault: Click the X, Y, Z endstop by hand, and observe whether the interface status is changed. Use a metal object to approach the bottom of the Proximity Sensor, observe whether the interface status changes, and whether the light of the Proximity Sensor is on.

Reason: If the state does not change, the X endstop, Y endstop, Z endstop and the proximity sensor may be broken.

Solution: Replace the XYZ endstops or proximity sensor.

8.2.3. Perform the action: turn on the "Auto home" function

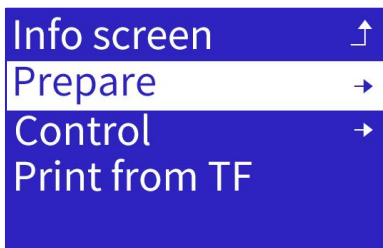

(1) Fault: The nozzle moves to the left and then stops.

Reason: The X endstop wire falls off and is broken. Or the X endstop is broken, please use the "Endstops" to check.

Solution: Reinsert or replace the X endstop cable, or replace the X endstop.

(2) Fault: The nozzle moves to the right, but keeps hitting the X endstop.

Reason: The X endstop wire is broken or short circuited. Or the X endstop is broken, please use the "Endstops" to check.

Solution: Replace the X endstop wire or the X endstop.

(3) Fault: The nozzle does not move and displays:

Reason: X motor cable fell off.

Solution: Replug the X motor cable.

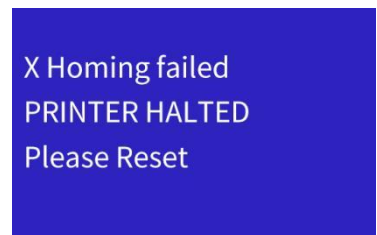

(4) Fault: The platform moves backward and hits the Y endstop all the time, showing:

Reason: The Y endstop wire falls off or is broken, or the Y endstop is

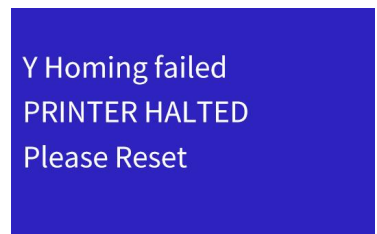

broken, please use the "Endstops" to check.

Solution: Reinsert or replace the Y endstop wire, or replace the Y endstop.

(5) Fault: The platform moves forward and then stops.

Reason: The Y endstop wire is broken or short circuited, or the Y endstop is broken, please use "Travel Switch Information" to check.

Solution: Replace the Y endstop wire or the Y endstop wire

(6) Fault: The platform does not move and displays:

Reason: Y motor cable fell off.

Solution: Replug the Y motor cable.



Y Homing failed
PRINTER HALTED
Please Reset

(7) Fault: The nozzle does not move upwards.

Reason: The Z endstop wire is off or broken, or the Z endstop is broken, please use the "Endstops" to check.

Solution: Reinsert or replace the Z endstop wire, or replace the Z endstop.

(8) Fault: The nozzle keeps moving upwards, then hits the Z endstop, and displays:

Reason: The Z endstop wire is broken or short circuited. Or the Z endstop is broken, please use the "Endstops" to check.

Solution: Replace the Z endstop wire, or the Z endstop.



Z Homing failed
PRINTER HALTED
Please Reset

(9) Fault: The nozzle does not move and displays:

Reason: Z motor cable fell off.

Solution: Replug the Z motor cable.



Z Homing failed
PRINTER HALTED
Please Reset

8.2.4. Perform the action: turn on the " Auto Level " function



(1) Fault: The nozzle will not go down (the light of the Proximity Sensor will not be on).

Reason: The proximity sensor wire falls off or is broken.

Solution: Replug or replace the proximity sensor wire.

(2) Fault: The nozzle keeps going down and hits the platform. The indicator light of the proximity sensor will also be on, but there is no output signal.

Reason: The proximity sensor wire is broken or short circuited. Or the proximity sensor is broken, please use the "Endstops" to check.

Solution: Replace the proximity sensor wire, or replace the proximity sensor.

8.3. Other issues

1. The model does not stick to the platform or is difficult to remove, what should I do?

If the gap between the nozzle and the platform is too large, the model will not stick to the platform. If the gap between the nozzles is too small, the model and the platform will adhere too tightly and it is difficult to remove them. Please use the Z offset function to adjust the gap between the nozzles and the platform.

2. What should I do if the nozzle hits the platform?

During automatic leveling, if the nozzle hits the platform, it may be caused by the high relative position of the Proximity Sensor and the nozzle.

If the extruder assembly has been replaced before, after loosening the screws securing the extruder, push the extruder up to the highest position, and then lock it.

Secondly, please use the height adjustment function of the Proximity Sensor to reduce the height of the Proximity Sensor. If the problem still cannot be solved, it may be that the Proximity Sensor is faulty, please contact us for after-sales replacement parts.

3. What should I do if the nozzle hits the endstop?

There may be a problem with the endstop or the XY motor. First, please check whether the XY endstop and the motor interface are loose. Secondly, please go through troubleshooting, find the point of failure, and then contact us for after-sales replacement parts.

4. The Auto Bed Leveling fails, what should I do?

First, please check whether the printing platform is installed and positioned. Secondly, please use the height adjustment function of the Proximity Sensor to reduce the height of the Proximity Sensor. If the problem still cannot be solved, it may be that the Proximity Sensor is faulty. Please find the fault point through troubleshooting, and then contact us for after-sales replacement parts.

5. The nozzle cannot be heated, what should I do?

Please find the fault point through the troubleshooting of the nozzle heating. If the problem still cannot be solved, please contact our after-sales department, and our technical engineer will provide more detailed guidance.

8.4. Maintenance

The daily maintenance mainly includes: cleaning the nozzle, replacing the magnetic sticker, maintenance of the optical axis and the screw rod, etc.

8.4.1. Power

- 1.If it is not used for a long time, please turn off the power.
- 2.Keep the place of use clean and dry. Prevent dust accumulation on the input and output ports of the power supply. The power supply should be protected from rain and direct sunlight.

8.4.2. Filament

After the printing is completed, please exit the remaining filament from the 3D printer and keep them sealed.

8.4.3. Clean Nozzle

During the 3D printing process, some dust may accumulate around the nozzle. Over time, these build-up can lead to clogging of the nozzle. Therefore, before printing, it is necessary to observe whether the printing nozzle is blocked and clean it.

Maintenance method:

1. Tweezers are generally used to clean the nozzle, and a wiping cloth can remove impurities.

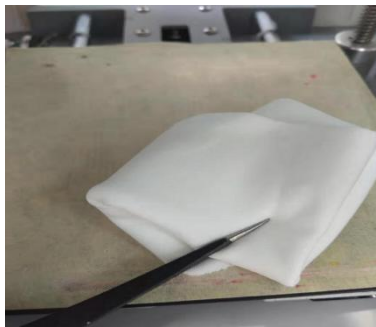

2. How to clear the blockage of the print head: Pull out the end of the guide tube connected to the nozzle (press the Tube Fitting to pull out the filament tube), heat the nozzle to 200 degrees, and use the 1.5mL wrench in the accessory box to enter the nozzle , until the clogged filaments are melted and extruded.

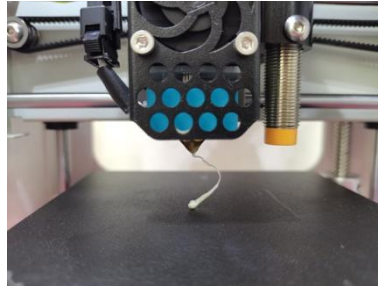
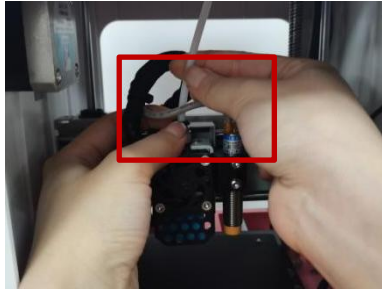

8.4.4. Replace Hotend

Improper operation or improper selection of filament will cause the nozzle to be blocked. If necessary, the Hotend needs to be replaced.

Disassembly process:

1. First, operate in the shutdown state, use a 2.0mm L-wrench to find the screw that fix the nozzle inside the nozzle fan, and loosen the screw.



2. Open the buckle and remove the Hotend from the bottom. The disassembly process of the Hotend is complete.



3. A new Hotend can be installed and replaced by operation in the reverse direction. After replacing the Hotend, the platform needs to be re-calibrated to start printing the model.

8.4.5. Bearings

During the use of the 3D printer, both X and Y directions rely on precision guide rails and Z axis screw to ensure smooth and precise linear motion. After adding lubricating silicone grease, it can reduce friction and reduce the wear of mechanical moving parts, so it must be maintained regularly. It is recommended to maintain once after 1000 hours of use.

Maintenance method: Get the lubricating silicone grease, apply it evenly on the screw rod or the optical axis, and then start the equipment to make the full stroke of each axis move several times, so that the lubricating silicone grease is evenly distributed on the surface of each axis.

