

FLOWTRON[®]

MODELS
FC-7200
FC-7600

FLY CONTROL

ELECTRONIC

OWNER'S MANUAL

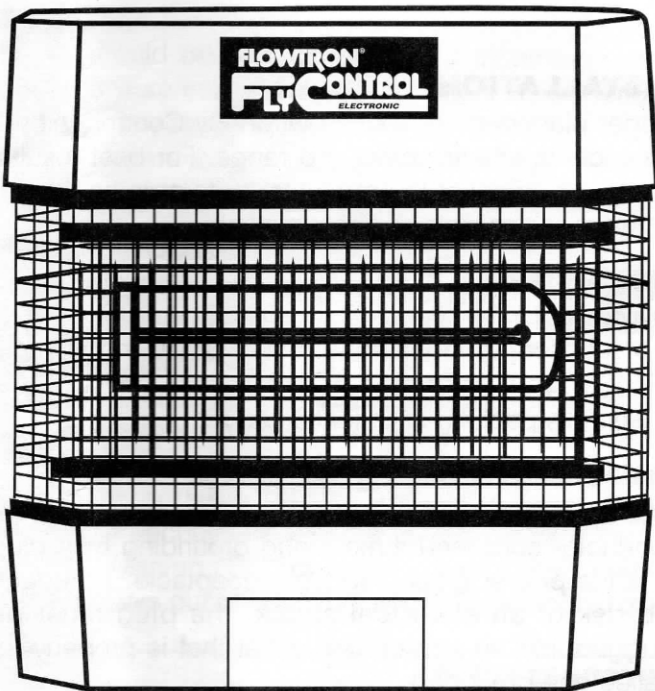

FC 7200

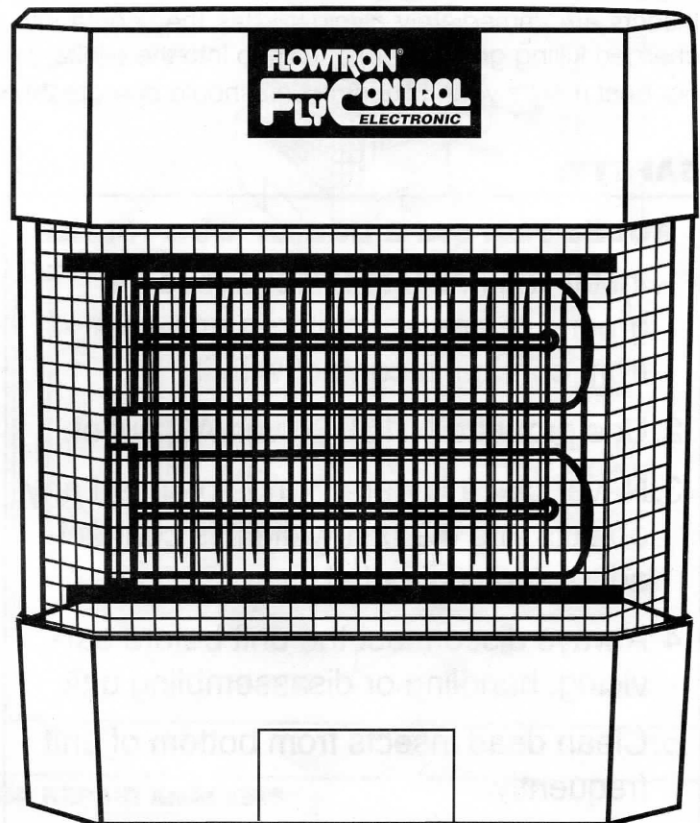

FC 7600

OPERATION • INSTALLATION • PARTS LIST

**FOR BEST RESULTS, READ THIS MANUAL BEFORE INSTALLING
YOUR NEW FLOWTRON ELECTRONIC BUG KILLER**

ONE YEAR LIMITED WARRANTY

Flowtron, division of Armatron, warrants your electronic bug killer to be free from defects in materials or workmanship under normal use and service for one year from date of the original purchase. All parts, except for burned out bulbs, which are defective, will be repaired free of charge. Any implied warranties, including the implied warranty of merchantability are also limited in duration to the one year period from the original purchase date.

The provisions of this warranty shall not apply to any bug killer which has been subject to misuse, neglect or accident, nor which is used for a purpose for which it is not designed, or which shall have been repaired or altered in any way as to adversely affect its performance and reliability. Service by unauthorized parties voids your warranty.

Flowtron neither assumes nor authorizes any person to assume for it any other liability in connection with its products. No responsibility is assumed for any consequential damages that may result from the use of a Flowtron product, nor for damages due to accident, abuse, lack of responsible care, the affixing of any unauthorized attachment, loss of parts or subjecting this unit to any but the specified voltage. Some states do not allow the exclusion or limitation of incidental or consequential damages, so the above limitation or exclusion may not apply to you.

If the unit fails to operate during the warranty period, send the product along with purchase receipt showing purchase date and description to: Flowtron Service Center, 1132 Main Street, Malden MA 02148. Transportation costs for returning any defective product are the responsibility of the consumer.

This warranty gives you specific legal rights and may also have other rights which vary from state to state.

For service information outside the USA contact your local dealer.

Flowtron has combined black light energy with an exclusive reflector panel to make your new insect killer a powerful fly control unit that is ecologically safe, effective and economical to operate.

Flies and other flying insect pests are attracted to the electrically charged inner killing grid by black light with help from our exclusive reflector panel, which substantially increases the units effectiveness in luring insect pests. Insects are immediately eliminated as they come into contact with, or pass between the rods of the electrically charged killing grid system and drop into the sanitary removable insect collection tray.

For best results your fly control unit should operate **24 hours a day, seven days a week.**

SAFETY:

RULES FOR SAFE USE OF BUG KILLER

1. Install the unit 6 to 8 feet above the ground to prevent children and pets from coming in contact with it.
2. Use grounded 115/120 volt AC outlet.
3. Never place fingers, hands or insert any objects into the unit while it is connected to electrical outlet.
4. Always disconnect the unit before servicing, handling or disassembling unit.
5. Clean dead insects from bottom of unit frequently.
6. Don't abuse power cord. Never carry unit by cord, or yank it to disconnect from receptacle.
7. Keep power cord from heat, oil and sharp edges. Repair damaged cords promptly.
8. This product is intended for **INDOOR** use only.

INSTALLATION:

Proper placement of your Flowtron Fly Control unit will enhance its effectiveness and range. For best results, place unit adjacent to entrances, exits or in heavily infested areas away from direct sunlight.

MOUNTING:

To mount unit:

1. Install screws in wall and mount unit using keyhole openings in rear panel.
2. Remove packing in collection tray.

GROUNDING INSTRUCTIONS:

Your bug killer is equipped with an appropriate three-conductor cord, and three-prong grounding type plug to fit the proper grounding type receptacle. To reduce the risk of an electrical shock, the plug must be plugged into an appropriate outlet that is properly installed and grounded.

Your bug killer has a grounding plug that looks like the plug shown, and is intended for use on a circuit that has an outlet as shown.

Consult a qualified electrician or serviceman if the grounding instructions are not completely understood, or if doubt as to whether proper grounding exists.

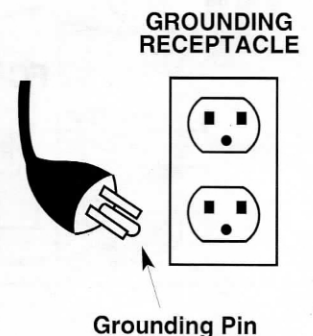

COLLECTION TRAY:

Your Flowtron Fly Control unit is equipped with a sanitary, removable collection tray.

To remove insects when wall mounted; slide collection tray forward to disengage tray from bottom plate. Remove by pulling downward (see Figure A). Reverse procedure to replace tray.

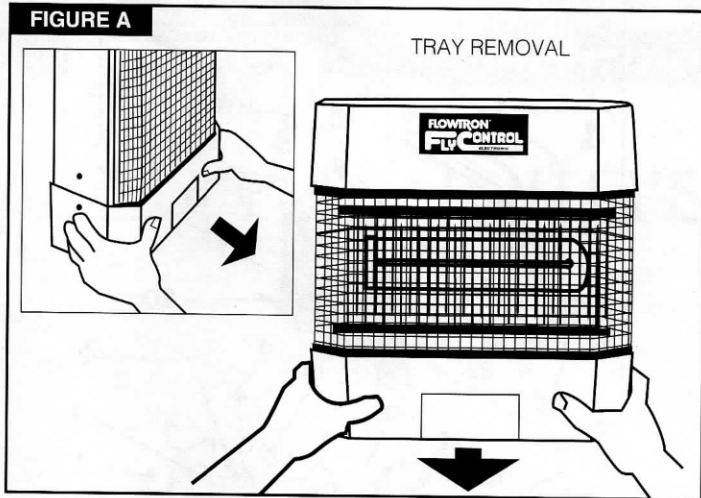

BULBS:

Bulbs should be replaced every 12 months of operation to ensure maximum output in the invisible ultraviolet frequency range.

Replacement bulbs can be purchased from your Flowtron dealer.

MAINTENANCE:

Other than the recommended cleaning and bulb replacement, no further user maintenance should be necessary.

Cleaning: Clean your insect killer at least once a year. The bulb should be cleaned periodically because dust build-up will inhibit ultraviolet light output. Clean with a small brush or blow out dead insects using a blower such as a portable hair dryer or the exhaust attachment of a vacuum cleaner. Be sure to unplug the unit before cleaning. Do not use a water hose or spray. Store indoors out of reach of children when not in use.

BULB REPLACEMENT: (FIGURE B)

Always disconnect the unit before servicing.

1. Remove right side panel.
2. Remove bulb retainer.
3. Grasp bulb and pull out of unit.
4. Insert replacement bulb.
5. Replace bulb retainer and side panel.

STARTER REPLACEMENT (FIGURE B)

1. Remove left side panel
2. Remove starter by twisting counter-clockwise.
3. Install replacement starter by placing into socket and twisting clockwise.
4. Replace side panel.

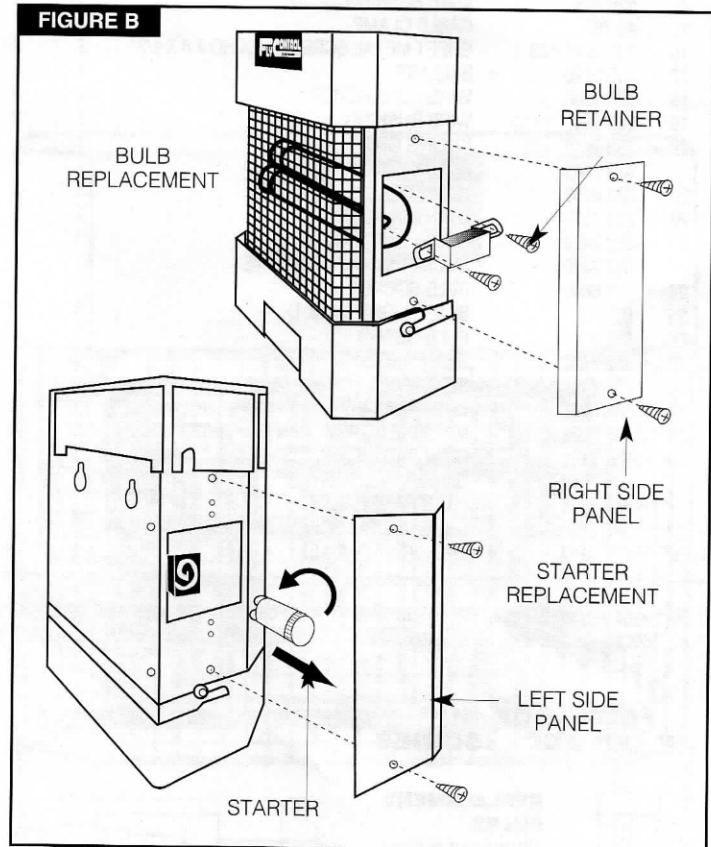

TROUBLESHOOTING AND REPAIR ANALYSIS

Problem	Possible Cause	Correction
A. Bulb(s) do not light and no voltage on grid.	1. No electrical power.	1. Check fuse or circuit breaker.
B. Bulb(s) light, but no grid voltage.	1. Shorted grids.	1. Examine grids to see if grid rods are free from foreign material, dirt or a build-up of dead insects.
	2. Transformer defective.	2. Replace transformer.
C. Grid voltage present, but bulbs do not light.	1. Bulb(s) not seated properly.	1. Check all sockets for proper seating and alignment.
	2. Starter defective.	2. Replace.
	3. Bulb(s) defective	3. Replace.
	4. Ballast defective.	4. Replace.
D. Intermittent or continuous sparking between grids.	1. Gap between grid rods too small.	1. Unplug unit and adjust grid rods by bending back into alignment using screwdriver blade.
	2. Grid clogged with foreign material.	2. Clean grid using an air blower.
	3. Grid not seated in insulator.	3. Look for proper grid seating at all insulators.
E. Decrease in luring effectiveness.	1. Insufficient U.V. output.	1. Replace bulb(s).

Any problems you encounter that are not corrected by the action recommended in this chart should be referred to the Flowtron Service Dept. 617-321 2300.

PARTS LIST

REF. #	PART #	DESCRIPTION	FC 7200	FC 7600
			QTY.	QTY.
1	555 3491	TOP COVER	1	1
2	505 7511	TOP PLATE ASSY.	1	1
	505 7539	TOP PLATE ASSY.	-	1
3	245 6269 P06	HEX NUT, SELF-LOCKING, #10-32	4	6
4	576 4659	* TRANSFORMER	1	1
5	245 6272 P04	FLAT WASHER, # 10	2	4
6	553 7417	PROTECTOR SCREEN	1	-
	553 7481	PROTECTOR SCREEN	-	1
7	505 7513	BOTTOM PLATE ASSY.	1	1
8	544 5826	GRID INSULATOR.	5	5
9	245 6245 P12	SHEET METAL SCREW, HEX HD # 6 X 1/2"	5	5
10	555 3492	COLLECTION TRAY	1	1
11	245 6236 P11	SHEET METAL SCREW, PAN HD # 6 X 3/8"	4	4
12	552 7421	ACCESS COVER	2	-
	552 7485	ACCESS COVER	-	2
13	512 2727	POWER CORD.	1	1
14	596 738	WIRE BUSHING, 3/8 ID	1	1
15	45 787	CABLE CLAMP	1	1
16	245 6245 P28	SHEET METAL SCREW, HEX HD # 8 X 1/2"	2	2
17	532 2790	* BALLAST	1	2
18	595 1506	WIRE CONNECTOR	4	6
19	596 395	WIRE BUSHING, 1/4 ID	2	2
20	553 7515	KILLING GRID	1	-
	553 7542	KILLING GRID	-	1
21	531 6750	STARTER	1	2
22	571 417	STARTER SOCKET	1	2
23	552 7420	SOCKET MOUNTING PLATE	1	-
	552 7499	SOCKET MOUNTING PLATE	-	1
24	571 6806	BULB SOCKET	1	2
25	BF150	BLACK LIGHT BULB, U	1	2
26	555 7516	BULB GUARD	1	2
27	552 7422	SIDE PANEL	2	-
	552 7483	SIDE PANEL	-	2
28	555 3061	BULB RETAINER	1	2
29	245 6224 P31	MACHINE SCREW, PAN HD # 8-32 X 3/8"	2	4
30	567 7496	BULB PAD	1	2
31	505 7512	BACK PANEL ASSY.	1	-
	505 7540	BACK PANEL ASSY.	-	1
32	245 6236 P28	SHEET METAL SCREW, PAN HD # 8 X 1/2"	8	8
33	557 7517	OWNER'S MANUAL	1	1

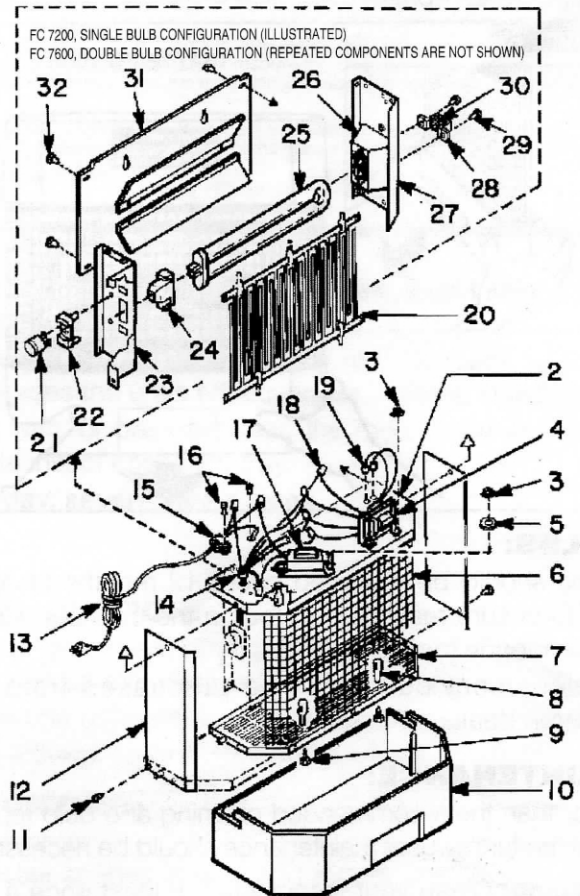
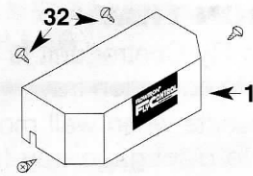
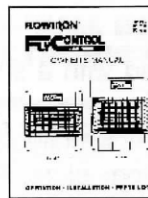

* FC 7200E — 220/240V, 50HZ, REQUIRES TRANSFORMER 576 3075 AND BALLAST 532 8376
 * FC 7600E — 220/240V, 50HZ, REQUIRES TRANSFORMER 576 3075 AND BALLAST 532 5223

FLOWTRON BUG KILLER ACCESSORIES

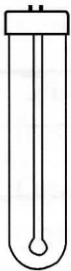

REPLACEMENT BULBS

Ultraviolet bulbs for Flowtron models and most other brands. Yearly replacement recommended to retain maximum black light output.



POWERFUL LURES Fly Sex Lure — Model FA-5000

Twice as effective as black light alone. Hooks right onto outer screen to provide 24 hour luring power. Effective for 30 days.

