



TF-1620PAR

**Toyota Falcon Pneumatic Auto 16" X 20"
Rotary Four Station Heat Press**

MANUAL



Please read these operating instructions carefully so you can start production with your press without problems. Reproduction of these operating instructions in any form requires the written approval of Toyoda Falcon. We reserve all rights to change technical data and product features. Toyoda Falcon does not assume any liability for direct or indirect damage resulting from use of this product.

BRIEF OVERVIEW

TF-1620PAR

Toyoda Falcon Pneumatic Auto 16" X 20" Rotary Four Station Heat Press

The design of the Toyoda Falcon Pneumatic Auto 16" X 20" Rotary Four Station Heat Press combines a heavy-duty solid steel industrial grade pressing framework with accurate and easy to use electronics. Utilize it's full auto feature as the press will automatically open within your desired time and rotate from one platen to the other. This provides the operator with the best possible features and equipment needed for today's various heat transfer applications.

By using the TF-1620PAR four station heat press, you'll be able to achieve all common heat transfer processes to the highest standard and productivity (sublimation, direct-to-film, direct-to-garment, screen print transfers, vinyl etc.) Your desired settings can be set easily with the easy to read oversized-digital LCD temperature controller and the pneumatic pressure can be regulated smoothly with the air reducing valve. With the restriction valve on the solenoid valve, the press and lift speed could be easily adjusted as well.

Four station heat presses significantly add to the productivity of heat transfer pressing by relieving the operator of the major manual tasks normally associated with the manual heat press processes.

FEATURES

- Pneumatic four station transfer press for medium and large batches
- Pressure balancing system on heat plate and bottom plate
- Industrial grade heavy duty heat press machine 16" x 20"
- Thick cast aluminum heat plate for evenly distributed temperature
- Flexibly adjustable air pressure by air reducing valve with water separator
- 5CE & ROHS approved
- 0.8MPa (120 PSI) for heavy pressure application
- Self-pressure balancing system
- Powered by an air compressor (Not Included)
- Includes teflon sheet on the heat plate
- Foot pedal included
- Table included

FEATURE DIAGRAM

- A.** Control panel
- B.** Solenoid valve (not shown)
- C.** Air reducing valve
- D.** Heat plate
- E.** Fabric holder
- F.** Height adjustable foot
- G.** Speed switch
- H.** Manual/Semi-auto/Auto switch
- I.** Rotate timer
- J.** Temperature controller
- K.** Heat plate lift button
- L.** Power switch
- M.** Rotate button
- N.** Heat plate press button
- O.** Emergency shut off button
- P.** Platen
- Q.** Pedal

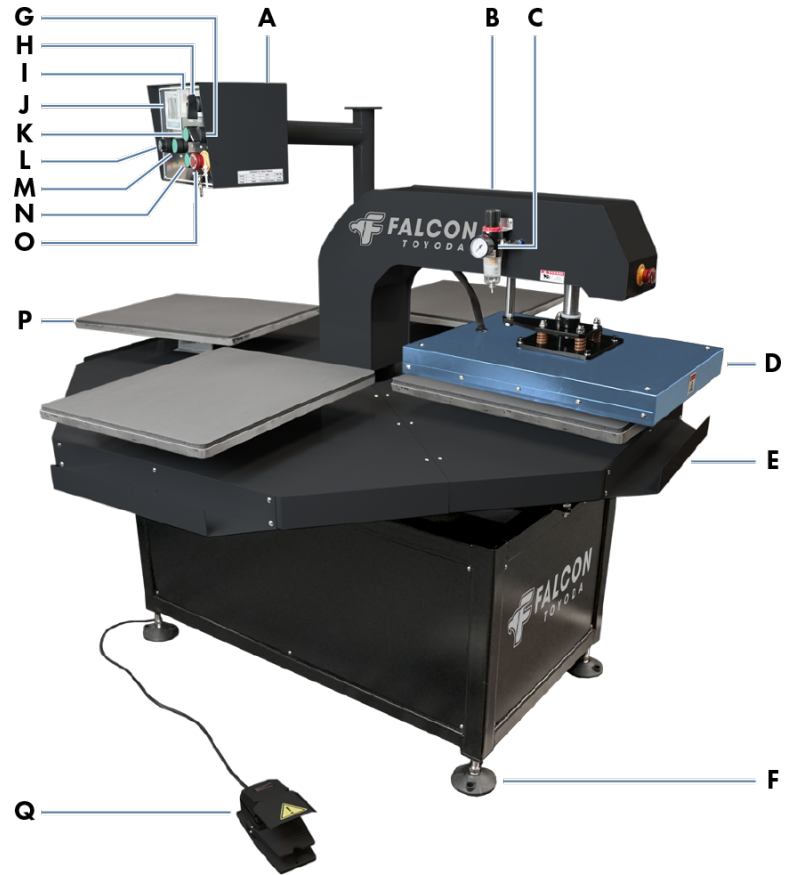

SAFETY PRECAUTIONS

Please read these instructions and safety precautions carefully before using your press for the first time!

- Never reach into the heat press with your hands when it is connected to the power supply, particularly when it is switched on and heated up – danger of severe burns!
- Do not open the cover or attempt to modify the machine yourself without instruction.
- In case you are requested by the Toyota Falcon customer support to open the heating plate cover, please make sure you are wearing respiratory protection and only touch the contained insulation wool with gloves. Any disposal of the wool must be contained in a closed bag.
- Ensure that liquids and metal objects do not get into the inside of the heat press.
- Ensure that the power socket used is grounded. Note that it is only permissible to operate a heat press from a power socket protected by a ground fault protection switch.
- Disconnect machine from power outlet when not in use.
- Never operate the heat press within the reach of children and never leave the machine unsupervised when switched on.
- Ensure that the machine is used only in dry rooms.
- Pay attention that the used compressor is attuned to the air consumption and the pressure

CONTROLLER

With the temperature controller, not only can you adjust the temperature of the press (°C and °F) but also the press time. Toyota Falcon heat presses allow you to display both the set value and the temperature of the press all on the same screen. Utilize the in-press counter (reset after power off) function to count the number of transfers that have been made during the current session.



Press and hold the SET button to enter parameter setting interface. Press and hold the SET button to exit parameter setting interface.





Press the down key to decrease the corresponding parameter value.



Press the up key to increase the corresponding parameter value. Press and hold the up key to start self-tuning (°C or °F on the panel blinks.) Once the machine begins self-tuning, do not unplug or press any key until the self-tuning is done (°C or °F stop blinking). Before apply self-tuning, set temperature to normal working temperature and let the heat plate cool down to room temperature. Apply self-tuning when the machine could not control temperature properly. Self-tuning will change PID parameter automatically.

Do not change parameters except Pb and SL2 without our instruction.

Parameter code		Function
	Pb	Temperature calibration: If measured temperature 1°C or 1°F lower than the showing temperature, decrease the value 1.
	SL2	0: Celsius (°C) 1: Fahrenheit (°F)

OPERATION

Pneumatic Connection

- TF-1620PAR requires air compressor with minimum 800w (1 hp) and 30L (8 gallon) hold tank.
- Connect 5mm inner diameter (usually 8mm outer diameter) air hose to the machine. Charge the compressor to 0.6-0.7 Mpa, up to 0.8 Mpa (120 psi) if possible.
- Set the desired air pressure on the air reducing valve of the heat press by pulling up the cap at the top end and then turning it. After the pressure is set, push the cap back down. The set pressure should be lower than on the manometer of the compressor. Commonly used pressures are between 0.4 to 0.6 Mpa (60 to 90 psi).

Power Supply

- Connect the heat press to 220V single phase electric wire.

Operating Transfers

- Set the desired air pressure on the air reducing valve of the heat press by pulling up the cap at the top end and then turning it. After the pressure is set, push the cap back down.
- Rotate timer: Set the interval time, machine rotates on station after the timer count to zero.
- Manual mode (0): Machine is only controlled by the button on the panel.
- Semi auto mode: Press pedal, machine will rotate and press 1 cycle.
- Auto mode: Machine will press and rotate automatically.
- Speed switch: Switch to slow or fast rotate speed.
- By pressing the red emergency stop button, transfer process can be stopped at any time.



Operation of Solenoid Valve

- On the side of the solenoid valve there are two silver/golden screws which restricting the air flow speed of the cylinder.
- If the screws are screwed out, it accelerates up/down process of the cylinder.
- When the screws are screwed in, it slows down up/down process of the cylinder
- Fix the respective setting with the corresponding counter nuts by tightening them by hand.

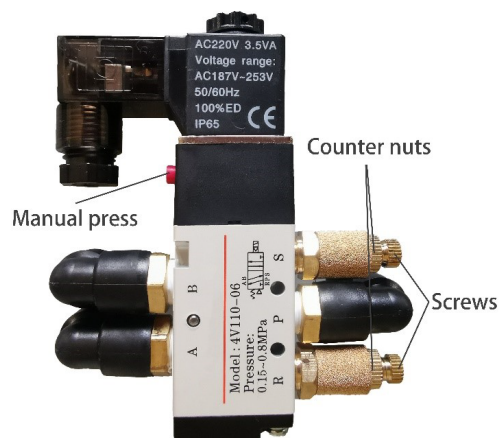

MAINTENANCE AND CLEANING

Maintenance work should always be accomplished with the press switched off and cooled down. The plug must first be disconnected from the power socket. Consult Technical Support before carrying out any maintenance work. Clean the press regularly with a soft cloth and mild household cleaner to remove adhesive residues etc.

Apply lubricating grease oil (3 teaspoons) on the rotate gear every year.

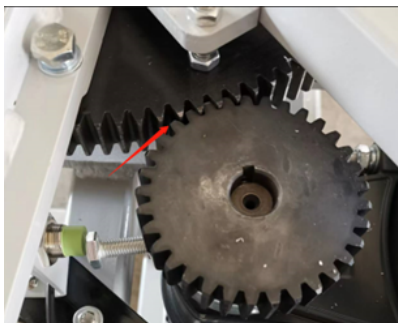

SPECIFICATIONS

Model: TF-1620PAR

Electrical: 220V, 2700w, Single Phase

Max Temp: 260°C (500°F)

Time Range: 0-999sec

Platen: 16" x 20"

Dimensions: 60" x 60" x 55"

Weight: 800 lbs

Crate Size: 57" x 40" x 70" x2

Crate Weight: 1140 lbs

INSTALLATION

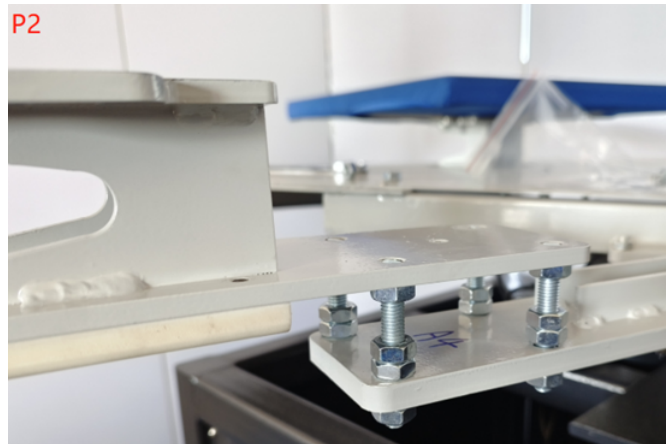
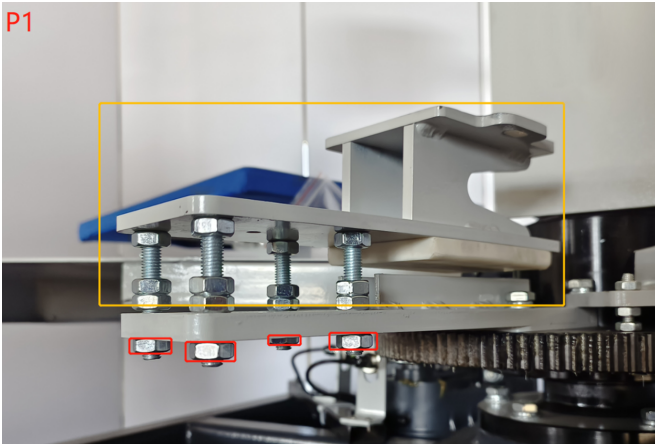

P1: Release the four nuts marked in red. Rotate the yellow part 180 degree and reinstall (shown as **P2**.)

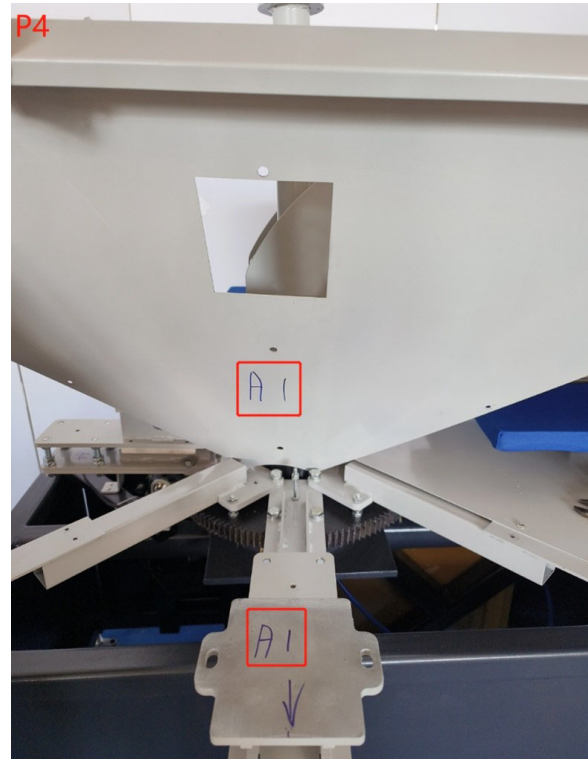

P3: Put a flat washer at the marked position.

P4: Match the cover mark and base mark (A1 in the picture,) install the four

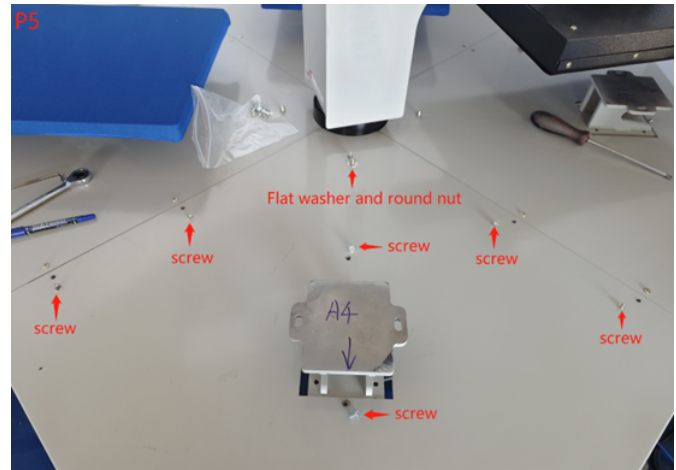
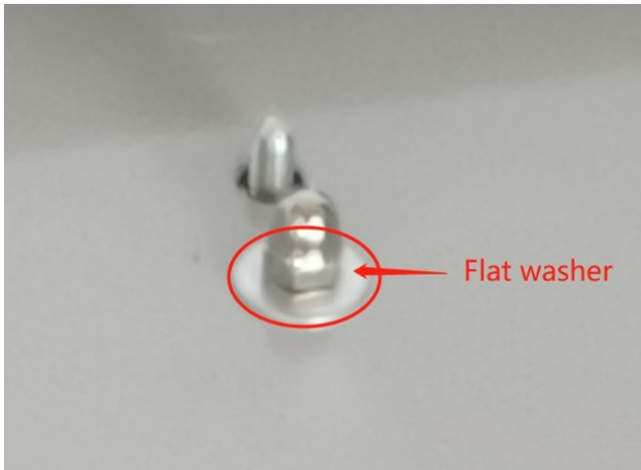

P5: Fix the four covers with screws as shown in the picture.

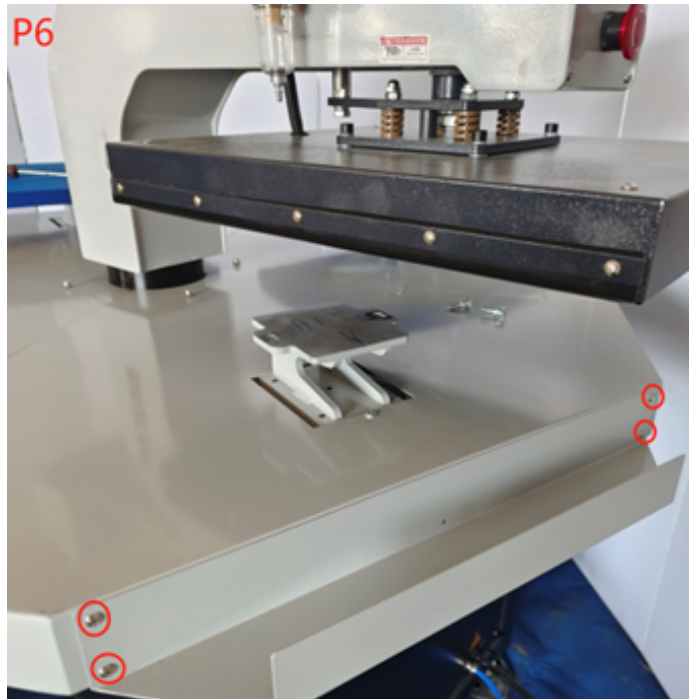

P6: Install the fabric tray (it is designed for long fabric press job, which can prevent the fabric from fall off, this part might not needed for regular t-shirt press)

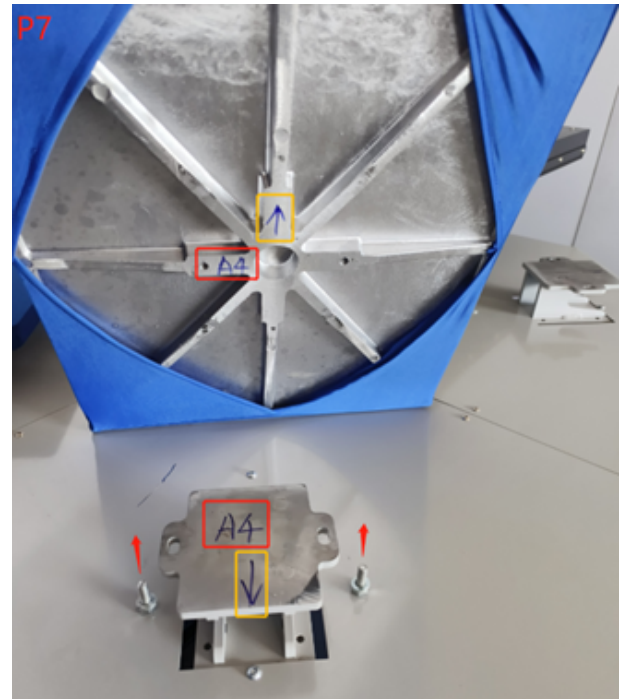

P7: Install the platen, match the mark (A4-A4) and the direction. We pre-aligned the platen to make it parallel to the heat plate to ensure the best pressure distribution. Fix the platen with screw, spring washer and flat washer.

P8

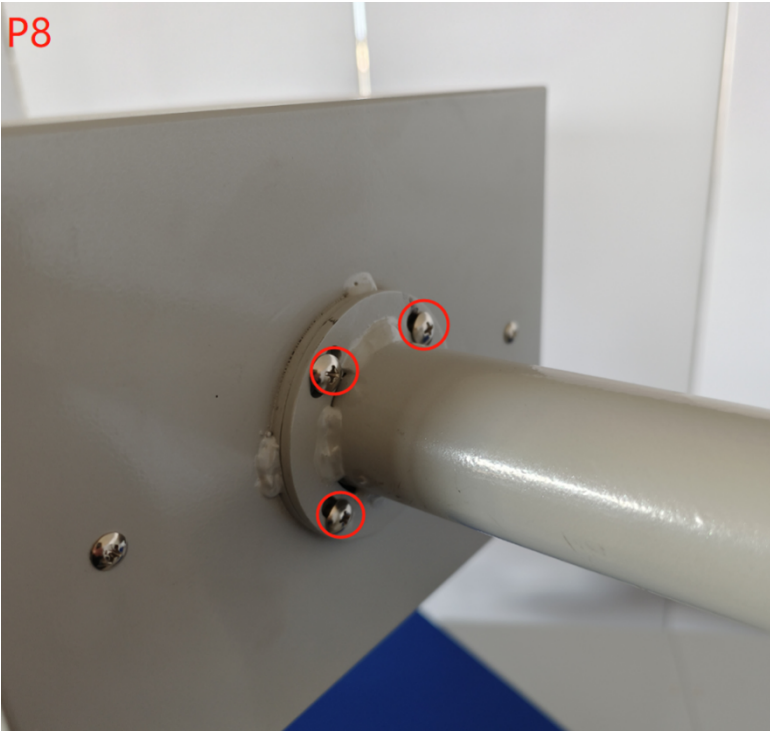

P8: Fix the control box with four screws.

CIRCUIT DIAGRAM

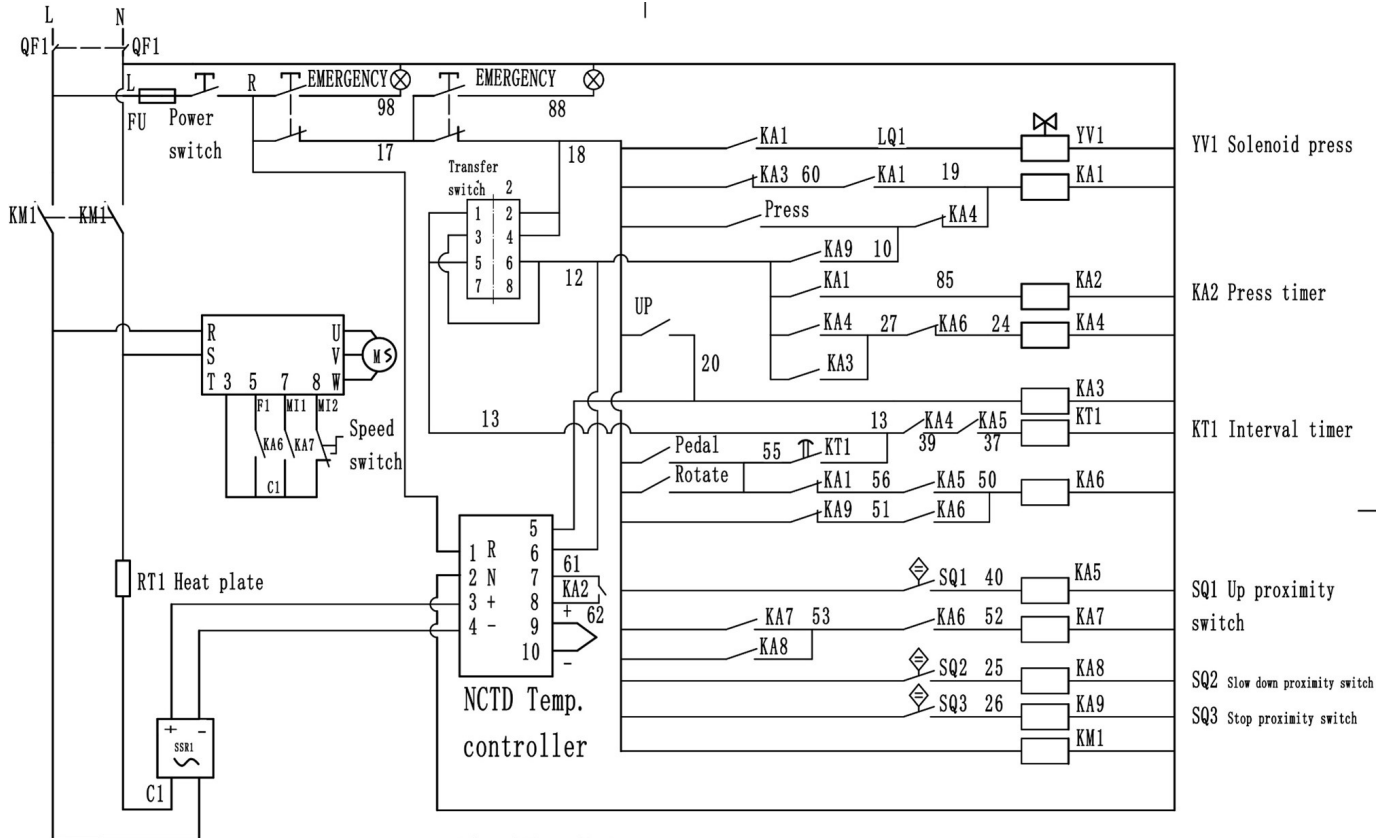

亚泰 台达 松下
 C1 = GND = 3
 F1 = M0 = 5
 M11 = M3 = 7
 CM12 = M4 = 8

CERTIFICATION

CE Certification

We herewith declare that the product meets the provisions of the following EC Directives and Harmonized Standards:

Certificate Number: M.2020.206.C9752

- 2006/42/EC Machinery Directive
- 2014/35/EU Low Voltage Directive
- Related Standards: EN ISO 12100:2010, EN 60204-1:2018



RoHS Test

We herewith declare that the product conforms to RoHS Directive 2011/65/EU Annex II amending Annex (EU) 2015/863 and amending Annex (EU) 2017/2102.



Report No.: B-R2203A0560