



Epson SureColor[®] P7500/P9500 Series

Contents

SureColor P7500/P9500 Series User's Guide	9
Introduction to Your Printer	10
Printer Features	10
Optional Equipment and Replacement Parts.....	11
Notations Used in the Documentation	12
Printer Part Locations.....	12
Product Parts - Front	13
Product Parts - Top/Inside.....	14
Product Parts - Back.....	15
Using the Control Panel	16
Control Panel.....	17
Changing the LCD Screen Language.....	18
Selecting the Date and Time	20
Setting an Administrator Password.....	21
Locking the General Settings.....	24
Using Power Saving Settings	24
Changing the Sleep Timer Settings	25
Changing the Power Off Timer Settings.....	27
Wired Networking	29
Network Security Recommendations	29
Selecting Network Settings from the Control Panel.....	30
Setting a Proxy Server from the Control Panel	31
Printing a Network Status Sheet.....	32
Printing a Network Connection Report	33
Network Connection Report Codes and Messages	35
Accessing the Web Config Utility.....	38
Media Handling	39
Roll Paper Handling	39
Loading Roll Paper	39
Cutting Roll Paper	47

Cutting Roll Paper Manually.....	47
Printing Cutting Guidelines	48
Removing Roll Paper.....	49
Cut Sheet Handling	53
Loading Cut Sheets	53
Loading Thick or Large Cut Sheets (Poster Board)	55
Creating Custom Paper Settings	57
Creating Custom Paper Settings Using Epson Media Installer.....	58
Downloading Epson Media Settings	59
Using the Paper Basket.....	61
Catching Printouts Under the Product	61
Catching Printouts in Front of the Product	63
Storing the Paper Basket.....	66
Using the Auto Take-up Reel	69
About the Optional Auto Take-up Reel	70
Take Up with the Printable Side In.....	70
Take Up with the Printable Side Out.....	74
Removing Media from the Optional Auto Take-up Reel.....	79
Available Epson Papers	81
Borderless Paper Type Compatibility	94
Printing from a Computer	96
Printing with Windows	96
Selecting Basic Print Settings - Windows	96
Paper Configuration Options - Windows	99
Advanced B&W Photo Options - Windows.....	100
Print Quality Options - Windows	100
Color Management Options - Windows	101
Advanced Color Controls - Windows	102
Paper Source Options - Windows	103
Roll Paper Options - Windows	103
Using Layout Manager - Windows	106
Selecting Print Layout Options - Windows.....	112
Reduce/Enlarge Options - Windows	113

Multi-Page Printing Options - Windows.....	113
Selecting Additional Settings - Windows	114
Saving, Sharing, and Customizing the Printer Settings	115
Saving and Sharing Print Settings - Windows	116
Saving and Sharing Media Settings - Windows.....	117
Editing Print Setting Displays - Windows	118
Printing Your Document or Photo - Windows.....	120
Checking Print Status - Windows.....	121
Selecting Default Print Settings - Windows.....	121
Changing the Language of the Printer Software Screens	122
Changing Automatic Update Options	124
Printing on a Mac	124
Selecting Basic Print Settings - Mac	125
Advanced Color Settings - Mac.....	129
Print Quality Settings - Mac.....	132
Print Options - Mac	132
Selecting Roll Paper Settings - Mac	133
Selecting Paper Configuration Settings - Mac	136
Selecting Print Layout Options - Mac.....	137
Managing Color - Mac	137
Color Matching Options - Mac.....	138
Sizing Printed Images - Mac.....	139
Selecting Printing Preferences - Mac	139
Printing Preferences - Mac.....	140
Printing Your Document or Photo - Mac	141
Checking Print Status - Mac.....	142
Using the Control Panel Menus.....	144
Accessing the Printer's Menus	144
Paper Setting Menu.....	145
Basic Settings Menu.....	154
Printer Settings Menu.....	156
Network Settings Menu	164
System Administration Menu.....	164

Maintenance Menu.....	166
Status Menu	168
Replacing Ink Cartridges and Maintenance Boxes.....	169
Purchase Epson Ink Cartridges and Maintenance Box	169
Ink Cartridge and Maintenance Box Part Numbers.....	169
Removing and Installing Ink Cartridges.....	170
Replacing Maintenance Boxes.....	173
Adjusting Print Quality.....	176
Print Head Maintenance.....	176
Print Head Nozzle Check.....	176
Checking the Nozzles Using the Product Control Panel	176
Checking the Nozzles Using a Computer Utility	177
Print Head Cleaning	179
Cleaning the Print Head Using the Product Control Panel	180
Cleaning the Print Head Using a Computer Utility.....	181
Running a Power Cleaning Using the Product Control Panel.....	184
Print Head Alignment	186
Aligning the Print Head Automatically Using the Product Control Panel	187
Aligning the Print Head Manually Using the Product Control Panel.....	188
Adjusting the Paper Feed Using the Product Control Panel	191
Cleaning the Roll Paper Feeder	192
Maintenance and Transportation	193
Replacing the Cutter.....	193
Replacing the Borderless Pads	196
Cleaning the Platen and Borderless Pad Edges.....	200
Wiping the Print Head	204
Cleaning the Print Head Cap Area	206
Moving or Transporting Your Product.....	214
Discharging Ink.....	217
Solving Problems	219
Checking for Software Updates.....	219
Product Status Messages	220

Resetting Control Panel Defaults	221
Solving Printer Problems	221
Printer Does Not Turn On	222
LCD Screen Shuts Off	222
Forgot the Administrator Password	222
Solving Printing Problems	222
Nothing Prints	222
Cannot Print Over a Network	223
Print Head Moves But Nothing Prints	224
Solving Paper Problems	224
Paper Feeding Problems	224
Roll Paper Jam Problems	225
Cut Sheet Paper Jam Problems	227
Paper Does Not Collect in the Basket or is Creased	229
Solving Print Quality Problems	229
Nozzle Check Pattern Prints Incorrectly	229
Overall Print Quality is Poor	230
Lines Are Misaligned	231
Prints are Scuffed or Smearred	231
Prints are Wrinkled	232
Margins Appear in Borderless Prints	232
Uninstalling Product Software - Windows	233
Uninstalling Product Software - Mac	234
Where to Get Help	235
Technical Specifications	236
Windows System Requirements	236
Mac System Requirements	237
Paper Specifications	237
Printable Area Specifications	239
Ink Cartridge Specifications	242
Dimension Specifications	243
Electrical Specifications	243
Environmental Specifications	244

Interface Specifications	245
Safety and Approvals Specifications	245
Notices	246
Important Safety Instructions.....	246
General Product Safety Instructions	246
Ink Cartridge Safety Instructions.....	248
LCD Screen Safety Instructions.....	249
FCC Compliance Statement.....	249
Binding Arbitration and Class Waiver	250
Trademarks	253
Copyright Notice.....	254
A Note Concerning Responsible Use of Copyrighted Materials.....	254
Default Delay Times for Power Management for Epson Products	254
Copyright Attribution	255

SureColor P7500/P9500 Series User's Guide

Welcome to the SureColor P7500/P9500 Series *User's Guide*.

For a printable PDF copy of this guide, [click here](#).

Introduction to Your Printer

Refer to these sections to learn more about your printer and this manual.

Note: The SureColor P9500 Series is shown in most illustrations in this manual, but the instructions apply to all models unless noted otherwise.

[Printer Features](#)

[Notations Used in the Documentation](#)

[Printer Part Locations](#)

[Using the Control Panel](#)

Printer Features

The Epson SureColor P7500/P9500 Series printers include these special features:

High productivity

Available 150-, 350-, or 700-ml high-capacity ink cartridges with next generation UltraChrome Pro12, 12-color, all-pigment ink

Reliability

- Improved anti-dust design for reduced print head nozzle maintenance
- PrecisionCore Micro TFP print head offers Precision Droplet Control

High resolution

- Prints at resolutions up to 2400 dpi
- Supports Enhanced Black Overcoat for deeper tones of black
- Improved PANTONE color reproduction with Orange, Green, and Violet inks

Easy-to-use setup and operation

- Intuitive, easy-to-read, 4.3-inch, color LCD touchscreen
- Included printer stand provides versatile placement options
- Easy-to-use software
- Improved media setting software
- Supports roll paper or one cut sheet up to 24 inches (610 mm) [SureColor P7500 Series] or 44 inches (1118 mm) [SureColor P9500 Series] wide

- No need to switch between Photo Black and Matte Black inks

[Optional Equipment and Replacement Parts](#)

Parent topic: [Introduction to Your Printer](#)

Optional Equipment and Replacement Parts

You can purchase genuine Epson ink, paper, and accessories from an Epson authorized reseller. To find the nearest reseller, visit proimaging.epson.com (U.S.) or proimaging.epson.ca (Canada), select your product series and product, and click the **Where to Buy** button. Or call 800-GO-EPSON (800-463-7766) in the U.S. or 800-807-7766 in Canada.

Note: Availability of accessories varies by country.

Option or part	Part number
Maintenance box	T699700
Cleaning Sticks	C13S090013
Borderless replacement pad kit	C13S210102
Replacement printer cutter blade	C12C815331
Internal 320GB Print Server	C12C934551
PostScript Print Server	C12C934571
Auto Take-Up Reel (SureColor P9500 Series)	C12C815321
Roll Media Adapters	C12C935931
24" SpectroProofer	SPECTRO24UVS
44" SpectroProofer	SPECTRO44UVS
ILS30EP Spectrophotometer Head	C12C932021
1-year extended Epson Preferred Plus service plan	EPP900B1
2-year extended Epson Preferred Plus service plan	EPP900B2

Parent topic: [Printer Features](#)

Notations Used in the Documentation

Follow the guidelines in these notations as you read your documentation:

- **Warnings** must be followed carefully to avoid bodily injury.
- **Cautions** must be observed to avoid damage to your equipment.
- **Notes** contain important information about your printer.
- **Tips** contain additional printing information.

Parent topic: [Introduction to Your Printer](#)

Printer Part Locations

Check the printer part illustrations to learn about the parts on your printer.

[Product Parts - Front](#)

[Product Parts - Top/Inside](#)

[Product Parts - Back](#)

Parent topic: [Introduction to Your Printer](#)

Product Parts - Front

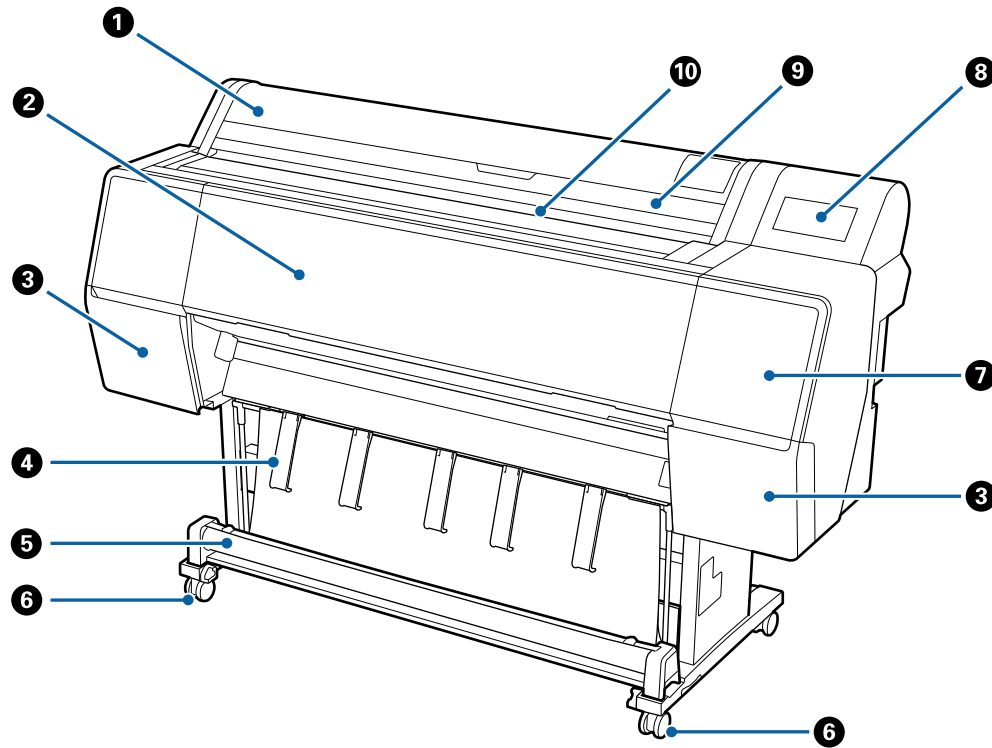

- 1 Roll paper cover
- 2 Front cover
- 3 Ink cartridge covers (left and right)
- 4 Paper guides
- 5 Paper basket
- 6 Casters
- 7 Maintenance cover (front)
- 8 Control panel
- 9 Cut sheet cover

10 Paper feed slot

Parent topic: [Printer Part Locations](#)

Product Parts - Top/Inside

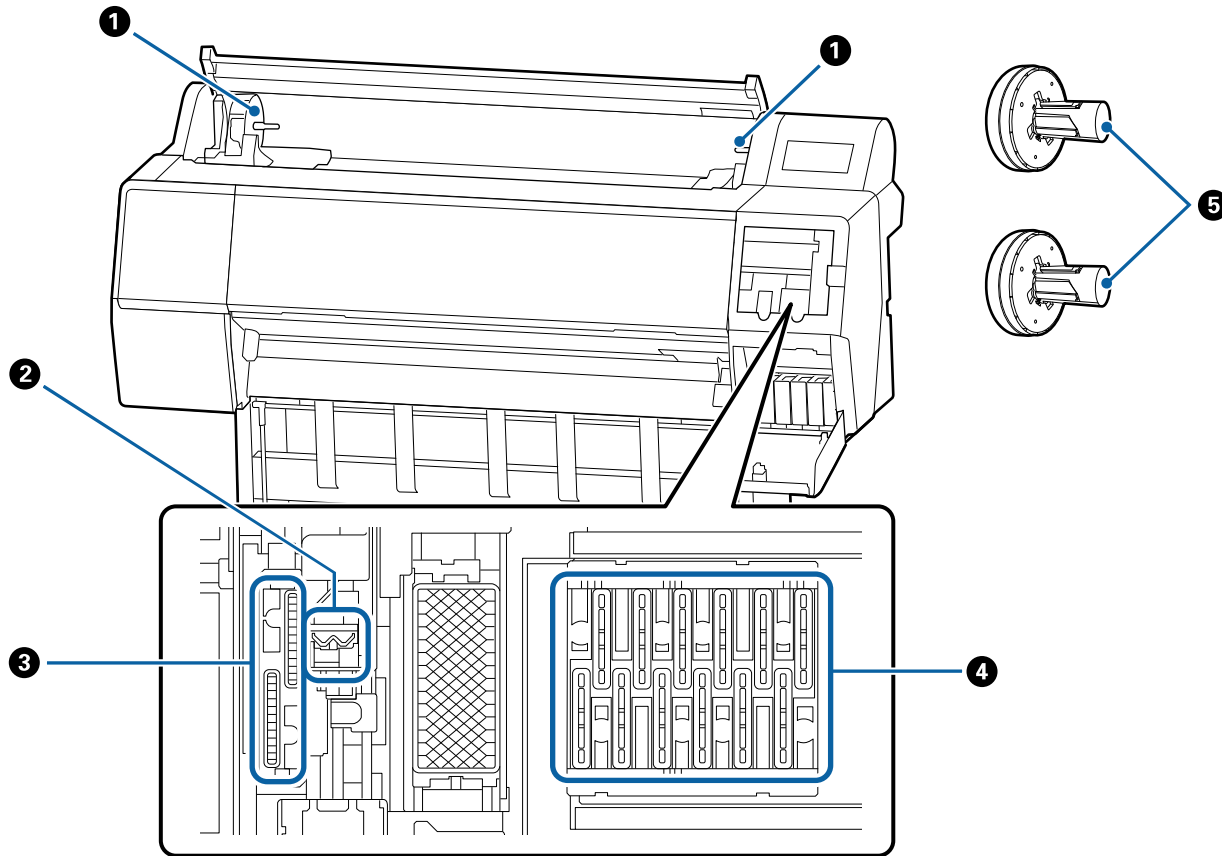

- 1 Roll paper holders
- 2 Wipers
- 3 Suction caps

- 4 Drying prevention caps
- 5 Roll paper adapters

Parent topic: [Printer Part Locations](#)

Product Parts - Back

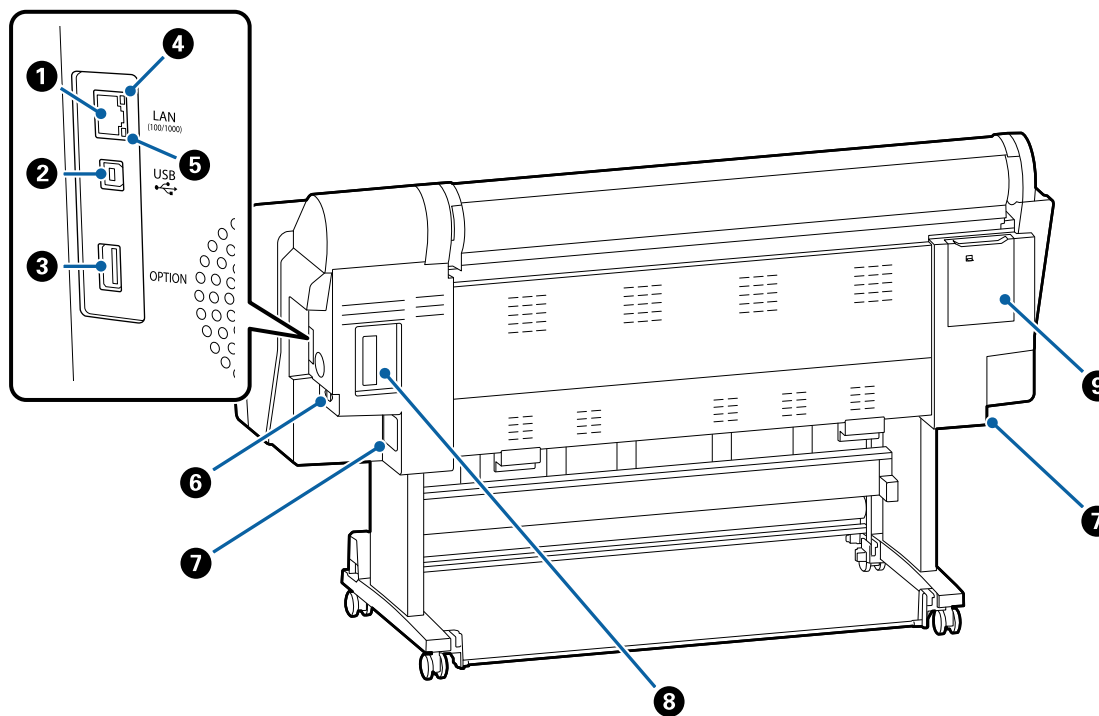

- 1 Ethernet **LAN** port
- 2 **USB** port
- 3 **OPTION** port (to connect optional equipment)
- 4 Network status light
- 5 Data light

- 6 AC inlet
- 7 Maintenance box (on right; SureColor P9500 Series has a second box on the left)
- 8 Option slot (to install optional print server)
- 9 Maintenance cover (back)

Parent topic: [Printer Part Locations](#)

Using the Control Panel

See these sections to learn about the control panel and select control panel settings.

[Control Panel](#)

[Changing the LCD Screen Language](#)

[Selecting the Date and Time](#)

[Setting an Administrator Password](#)





[Locking the General Settings](#)

[Using Power Saving Settings](#)

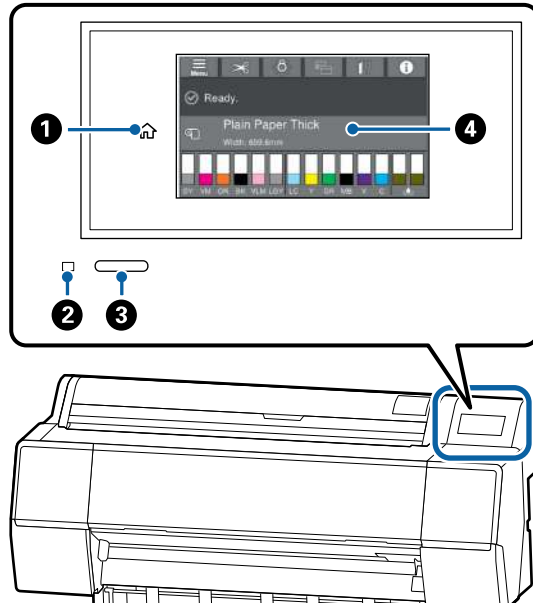
Parent topic: [Introduction to Your Printer](#)



Control Panel

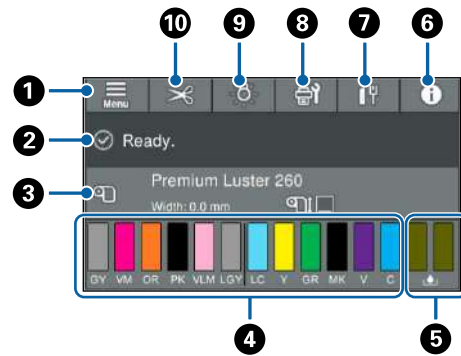

- 1  home button
- 2  Power light
- 3  Power button
- 4  LCD touchscreen

LCD Screen Display



- 1 Access menu items
- 2 Information display area
- 3 Paper information area
- 4 Ink level display
- 5 Maintenance box level display
- 6 Access information/job history
- 7 Network status icons
 -  : No Ethernet connection
 -  : Ethernet connection established
- 8 Displays the **Maintenance** menu
- 9 Turns the internal light on or off
- 10 Displays settings for feeding and cutting roll paper

Parent topic: [Using the Control Panel](#)

Changing the LCD Screen Language

You can change the language used on the LCD screen.

1. Press the  home button, if necessary.

2. Select the **Menu** icon.

You see a screen like this:

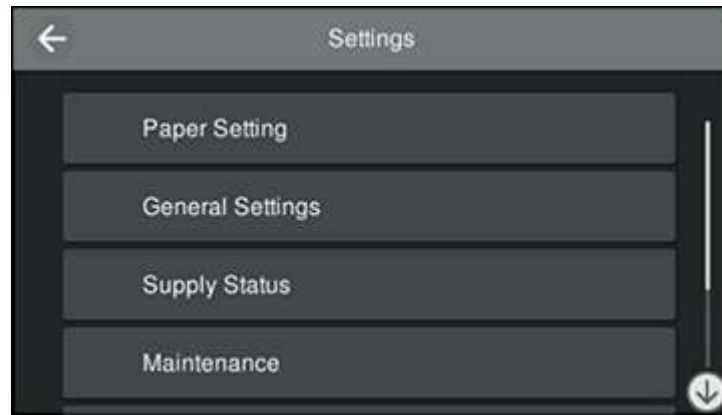

3. Select **Language**.

You see a screen like this:



4. Select a language.
5. Press the  home button to exit.

Parent topic: [Using the Control Panel](#)

Selecting the Date and Time

Before using your product, select the current date, time, and daylight saving phase in your area, and choose your preferred date and time format.

Note: This setting can be locked by an administrator. If you cannot access or change this setting, contact your administrator for assistance.

1. Press the  home button, if necessary.
2. Select the **Menu** icon.

You see a screen like this:

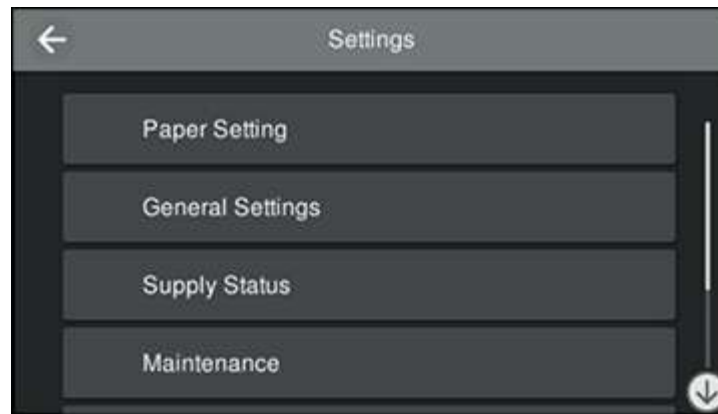

3. Select **General Settings > Basic Settings > Date/Time Settings**.

You see a screen like this:

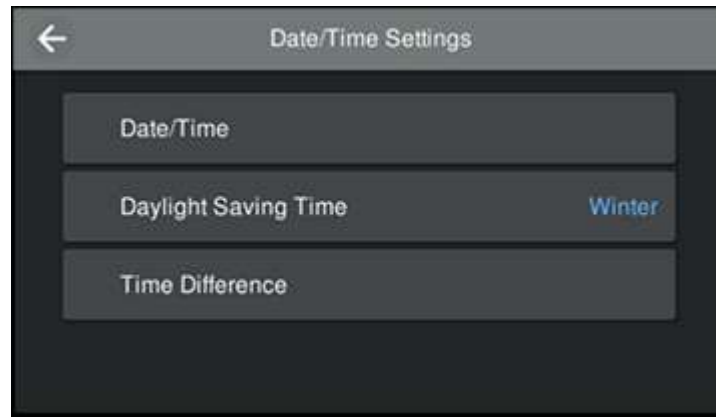

4. Select **Date/Time**.
5. Select the date format you want to use.
6. Use the on-screen keypad to enter the current date and select **OK**.
7. Select the time format you want to use.
8. Use the on-screen keypad to enter the current time and select **OK**.
9. Select **Daylight Saving Time** and select either **Summer** or **Winter**.
10. Press the  home button to exit.

Parent topic: [Using the Control Panel](#)

Setting an Administrator Password

You can set an administrator password to lock the following settings and prevent them from being changed:

- Network settings
- Certain Basic Settings
- Certain Printer Settings
- Certain Maintenance Settings
- System Administration settings

- Web Config settings
- EpsonNet Config settings

Note: The locked settings may differ depending on your product.

Note: This setting can be locked by an administrator. If you cannot access or change this setting, contact your administrator for assistance. For more information on administration settings, see the [Administrator's Guide](#).

1. Press the  home button, if necessary.
2. Select the **Menu** icon.

You see a screen like this:

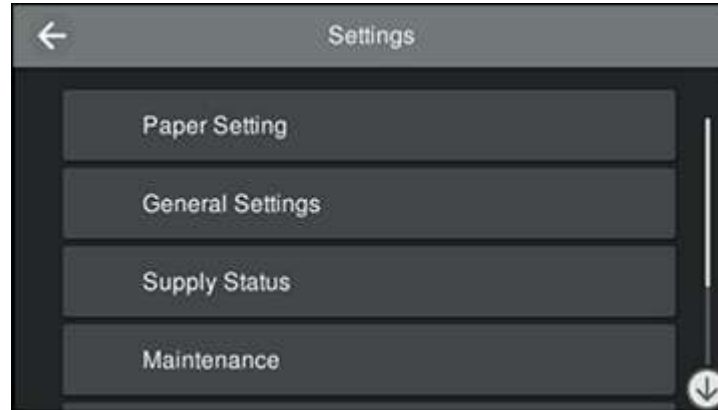

3. Select **General Settings > System Administration > Security Settings > Admin Settings**.

You see a screen like this:

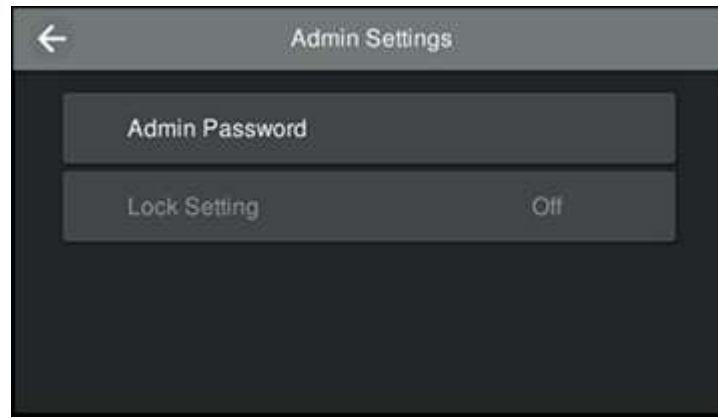

4. Select **Admin Password**.
5. Select **Register**.
6. Use the on-screen keyboard to enter a password and select **OK**.
7. Enter the password again to confirm and select **OK**.

Note: Keep a copy of your password in a safe place.

8. Select **OK**.
9. Select **Lock Setting > On** to lock the settings.

A prompt appears confirming that you want to enable locked settings. Select **Yes** to enable the setting and return to the home screen.

You must enter the admin password to access any of the locked settings.

Note: If you forget your password, contact Epson for assistance.

Parent topic: [Using the Control Panel](#)

Related tasks

[Locking the General Settings](#)

Locking the General Settings

If you have set an administrator password, you can use the Web Config interface or the control panel to prevent non-administrators from changing the settings in the **General Settings** menu.

1. Make sure you have set an administrator password.
2. Do one of the following:
 - To lock the settings using Web Config, access Web Config and log in using the administrator name and password. Select **Device Management > Control Panel**. Enable the **Panel Lock** setting and click **OK**.
 - To lock the settings using the control panel, select **Menu > General Settings > System Administration > Security Settings > Admin Settings**. Enable the **Panel Lock** setting. Select **Yes** on the confirmation screen.

The settings in the **General Settings** menu are locked if you are not logged in as an administrator.

Some locked settings may still be available through other features of the product. The following settings are available through the **General Settings** menu even when the **Panel Lock** setting is enabled:

- **LCD Brightness**
- **Sounds**
- **Language**
- **Keyboard**
- **Length Unit**
- **Paper Source Settings**
- **Custom Paper Setting**
- **Thick Paper**
- **Bidirectional**

Parent topic: [Using the Control Panel](#)

Related tasks

[Setting an Administrator Password](#)

[Accessing the Web Config Utility](#)

Using Power Saving Settings

Your product enters sleep mode automatically and turns off the LCD screen if it is not used for a period of time. You can make the time period shorter and select other options to save energy and resources.

[Changing the Sleep Timer Settings](#)
[Changing the Power Off Timer Settings](#)

Parent topic: [Using the Control Panel](#)

Changing the Sleep Timer Settings

You can adjust the time period before your product enters sleep mode and turns off the LCD screen.

1. Press the  home button, if necessary.
2. Select the **Menu** icon.

You see a screen like this:

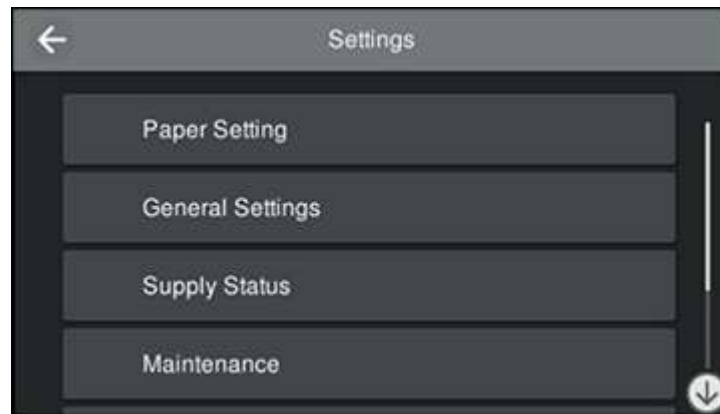

3. Select **General Settings** > **Basic Settings**.

You see a screen like this:

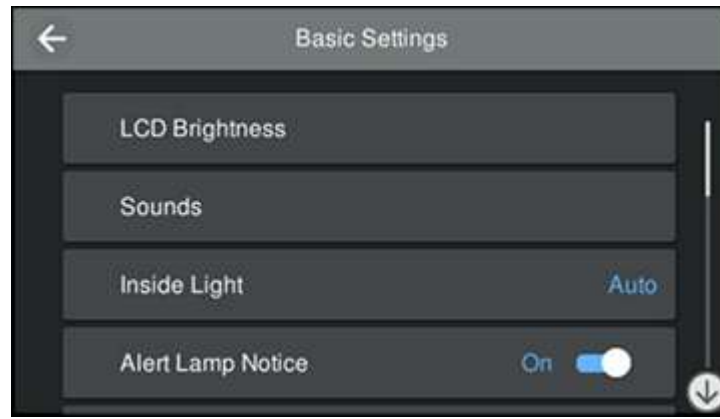

4. Select **Sleep Timer**.

You see a screen like this:

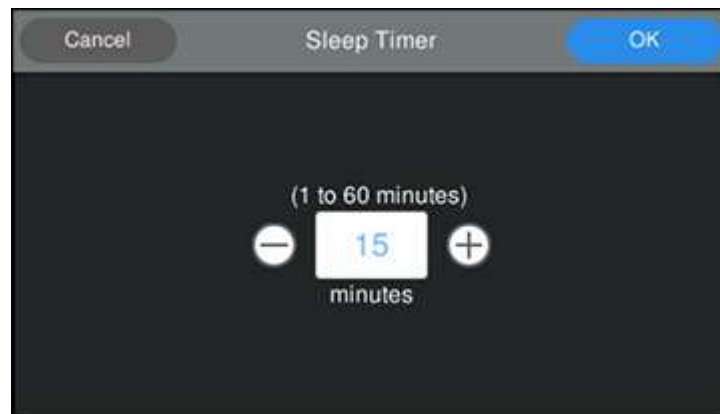

5. Do one of the following:
 - Press the + or – button to increase or decrease the number of minutes.
 - Press the number to display the on-screen keypad, select the number of minutes, and select **OK**.
6. Select **OK**.

Parent topic: [Using Power Saving Settings](#)

Changing the Power Off Timer Settings

You can have the product turn off automatically if it is not used for a specified period of time.

1. Press the  home button, if necessary.
2. Select the **Menu** icon.

You see a screen like this:

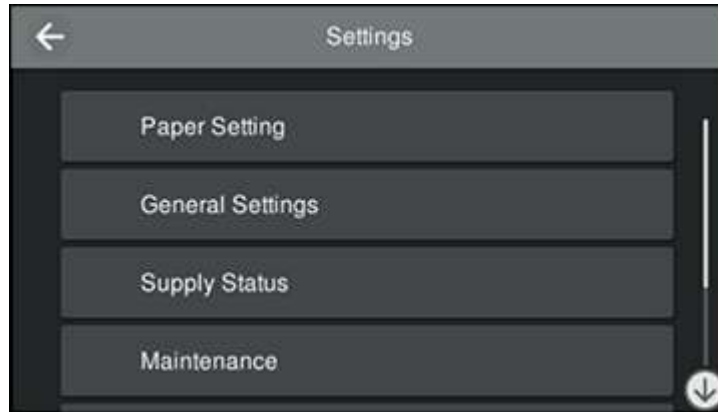

3. Select **General Settings > Basic Settings**.

You see a screen like this:

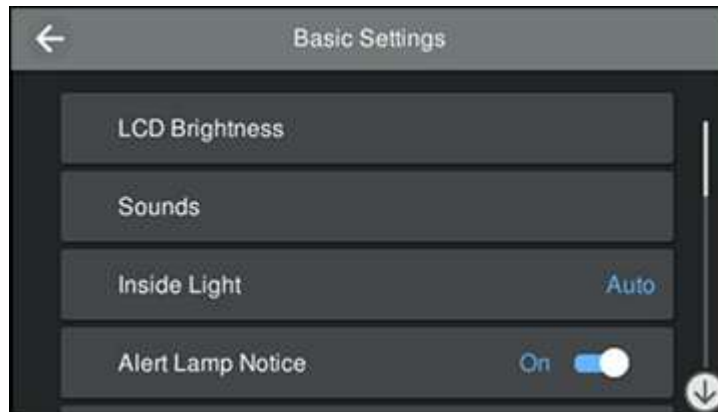

4. Select **Power Off Timer**, then select a time period between **30minutes** and **12h** (12 hours).

Parent topic: [Using Power Saving Settings](#)

Wired Networking

See these sections to use your product on a wired network.

Note: Epson recommends connecting the computer and printer without using wireless components. This prevents bandwidth limitations inherent to wireless communication as well as potential reductions to print speed and driver performance.

[Network Security Recommendations](#)

[Selecting Network Settings from the Control Panel](#)

[Setting a Proxy Server from the Control Panel](#)

[Printing a Network Status Sheet](#)

[Printing a Network Connection Report](#)

[Accessing the Web Config Utility](#)

Network Security Recommendations

To help deter unauthorized access to your product over a network, you should protect your network environment using appropriate security measures.

Security measures such as these can help deter threats such as loss of user data, use of telephone and fax lines, and other intrusions:

- **Enable security on your wireless LAN**

Enable the appropriate security on the wireless LAN you plan to use with your product. Network security such as a network password can deter interception of traffic over the wireless LAN. Your router may already have a default password enabled by your Internet service provider (ISP). See your ISP and router documentation for instructions on how to change the default password and better secure your network.

- **Connect your product only to a network protected by a firewall**

Connecting your product directly to the Internet may leave it vulnerable to security threats. Instead, connect it to a router or other network connection protected by a firewall. Your router may already have a firewall set up by your Internet service provider; check with your ISP for confirmation. For best results, set up and use a private IP address for your network connection.

- **Change the default administrator password on your product**

If your product has an option to set an administrator password, change the default administrator password to deter access by unauthorized users to personal data stored on your product, such as IDs, passwords, and contact lists.

Parent topic: [Wired Networking](#)

Selecting Network Settings from the Control Panel

If you need to assign a static IP address to the printer, you can manually set up the network connection via the control panel (as described below) or using the Web Config utility.

Note: This setting can be locked by an administrator. If you cannot access or change this setting, contact your administrator for assistance.

1. Press the  home button, if necessary.
2. Select **Menu > General Settings > Network Settings > Advanced > TCP/IP**.

You see a screen like this:



3. Set **Obtain IP Address** to **Manual**.
4. Select **IP Address** and use the on-screen keyboard to enter the address.
5. Enter values for **Subnet Mask** and **Default Gateway**.
6. Enter and confirm the IP addresses for the primary and secondary DNS servers, if necessary.
7. Confirm the displayed network settings and select **Start Setup** to save them.

8. Press the  home button to exit.

You should be able to connect to your product directly from your computer or device, and then print. If you are printing from a computer, make sure you installed the printer software from the Epson website.

Parent topic: [Wired Networking](#)

Related tasks

[Accessing the Web Config Utility](#)

Setting a Proxy Server from the Control Panel

You can set a proxy server using your product control panel (as described below) or the Web Config utility.

You need to set up a proxy server if your network uses a proxy server to access the internet and you want to update the product firmware using Web Config.

Note: This setting can be locked by an administrator. If you cannot access or change this setting, contact your administrator for assistance.

1. Press the  home button, if necessary.
2. Select **Menu > General Settings > Network Settings > Advanced > Proxy Server**.

Note: If you already set the product's IP address, selecting **Menu** may display the **Advanced** menu directly. If so, just select **Proxy Server**.

You see a screen like this:

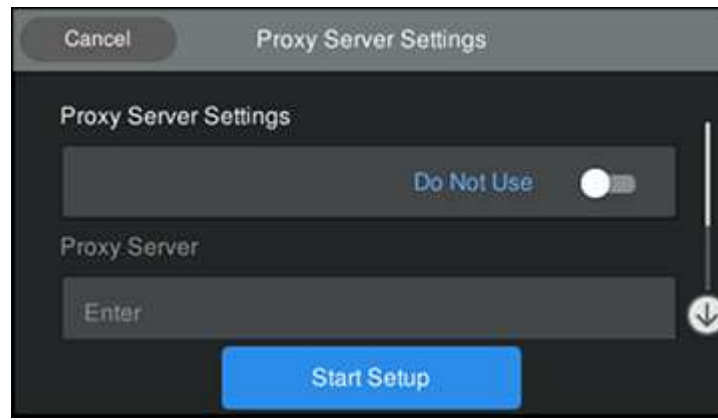

3. Set **Proxy Server Settings** to **Use**.
4. Enter and confirm the address for the proxy server in IPv4 or FQDN format using the on-screen keyboard.
5. Enter and confirm the port number for the proxy server as the **Proxy Server** setting.
6. Confirm the displayed network settings and select **Start Setup** to save them.
7. Press the  home button to exit.

Parent topic: [Wired Networking](#)

Related tasks

[Accessing the Web Config Utility](#)

Printing a Network Status Sheet

You can print a network status sheet to help you determine the causes of any problems you may have using your product on a network.

Before you begin, make sure paper is loaded in the product.

1. Press the  home button, if necessary.
2. Select **Menu > General Settings > Network Settings > Network Status**.

You see a screen like this:

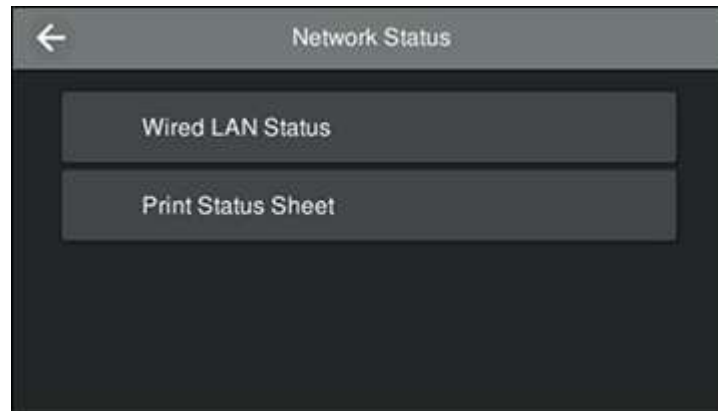

3. Select **Print Status Sheet**.

Examine the settings shown on the network status sheet to diagnose any problems you have.

Parent topic: [Wired Networking](#)

Related tasks

[Printing a Network Connection Report](#)

Printing a Network Connection Report

You can print a network connection report to view solutions to any problems you may have using your product on a network.

1. Press the  home button, if necessary.
2. Select **Menu > General Settings**.

You see a screen like this:

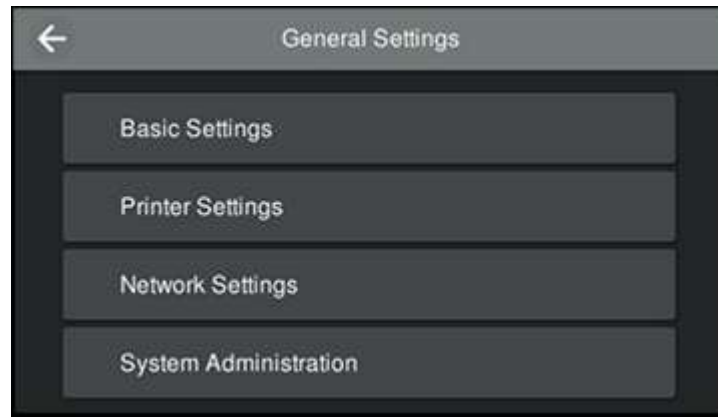

3. Select **Network Settings > Connection Check > Print Check Report**.

Examine the error codes and solutions shown on the network connection report.

[Network Connection Report Codes and Messages](#)

Parent topic: [Wired Networking](#)

Related tasks

[Printing a Network Status Sheet](#)

Network Connection Report Codes and Messages

Check the error codes and messages on the network connection report to solve problems you may encounter with network connections. The tables here list solutions to problems based on the error codes and messages that may appear on the top of the report.

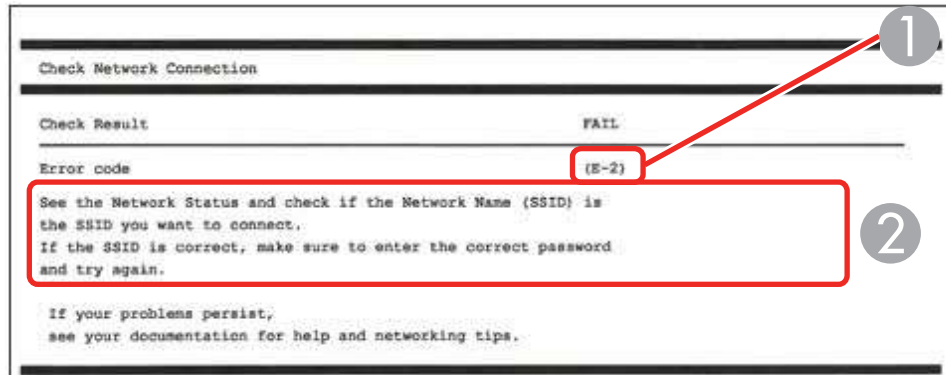

- 1 Error code
- 2 Message

Note: Error codes and messages listed here may not all apply to your product.

Error Codes and Messages

Error code and message	Solution
E1 Confirm that the network cable is connected and network devices such as hub, router, or access point are turned on.	Make sure your router, access point, and/or hub are turned on, and the network cable is securely connected to your device and to your product.

Error code and message	Solution
<p>E8</p> <p>Incorrect IP address is assigned to the printer. Confirm IP address setup of the network device (hub, router, or access point). Contact your network administrator for assistance.</p>	<p>If your product's Obtain IP Address setting is set to Auto, enable DHCP on your router or access point. If it is set to Manual, the IP address may be out of range or on a different network segment; set a valid IP address using your product control panel or the Web Config utility.</p> <p>You can also try turning off your product and the router or access point, waiting about 10 seconds, and turning them on again.</p>
<p>E9</p> <p>Confirm the connection and network setup of the PC or other device. Connection using the EpsonNet Setup is available. Contact your network administrator for assistance.</p>	<p>Make sure your computer or network device are turned on. Also make sure that you can access the Internet and other devices on the same network from the devices you are trying to connect to your product.</p> <p>If you still cannot connect to your product, turn off your router or access point, wait about 10 seconds, and turn it on again. Download and install your product software again to reset your network settings.</p>
<p>E10</p> <p>Confirm IP address, subnet mask, and default gateway setup. Connection using the EpsonNet Setup is available. Contact your network administrator for assistance.</p>	<p>Make sure other devices on the network are turned on and do the following:</p> <ul style="list-style-type: none"> • If your product's Obtain IP Address setting is set to Manual, check the IP address, subnet mask, and default gateway addresses on the network connection report to see if they are correct. If not, correct the settings. • If DHCP is enabled, set your product's Obtain IP Address setting to Auto. If you want to use the DHCP-assigned address as a static address, set the Obtain IP Address setting to Manual, enter the product's IP address as listed on the network connection report, and set the subnet mask to 255.255.255.0. <p>If you still cannot connect to your product, turn off your router or access point, wait about 10 seconds, and turn it on again.</p>

Error code and message	Solution
<p>E11 Setup is incomplete. Confirm default gateway setup. Connection using the EpsonNet Setup is available. Contact your network administrator for assistance.</p>	<p>If you set your product's TCP/IP Setup setting to Manual, check that the default gateway address listed on the network connection report is correct. Also turn on the device that is set as the default gateway.</p>
<p>E12 Confirm the following -Entered security key/password is correct -Index of the security key/password is set to the first number -IP address, subnet mask, or default gateway setup is correct Contact your network administrator for assistance.</p>	<p>Make sure other devices on the network are turned on and do the following:</p> <ul style="list-style-type: none"> • Make sure the IP address, subnet mask, and default gateway addresses are correct, if you are entering them manually. • Confirm that the subnet mask and default gateway addresses for other devices are the same. • Make sure the IP address does not conflict with other devices. <p>If you still cannot connect to your product, do the following:</p> <ul style="list-style-type: none"> • Turn off your router or access point, wait about 10 seconds, and turn it on again. • Download and install your product software again to reset your network settings. • If your router or access point uses WEP security with several registered passwords, make sure that the first registered password is set on your product.

Error code and message	Solution
<p>E13</p> <p>Confirm the following</p> <ul style="list-style-type: none"> -Entered security key/password is correct -Index of the security key/password is set to the first number -Connection and network setup of the PC or other device is correct <p>Contact your network administrator for assistance.</p>	<p>Make sure your router, access point, and/or hub are turned on. Also make sure the TCP/IP setup on your router, access point, and/or hub is not set manually; this may cause your product's network settings to differ from the manually set up devices.</p> <p>If you still cannot connect to your product, do the following:</p> <ul style="list-style-type: none"> • Turn off your router or access point, wait about 10 seconds, and turn it on again. • Download and install your product software again to reset your network settings. • If your router or access point uses WEP security with several registered passwords, make sure that the first registered password is set on your product.

Parent topic: [Printing a Network Connection Report](#)

Related tasks

[Accessing the Web Config Utility](#)

[Selecting Network Settings from the Control Panel](#)

[Setting a Proxy Server from the Control Panel](#)

Accessing the Web Config Utility

You can select your product's network settings and confirm its operating status using a web browser. You do this by accessing your product's built-in Web Config utility from a computer or other device that is connected to the same network as your product.

1. Print a network status sheet.
2. Locate the IP address for your product that is listed on the network status sheet.
3. On a computer or other device connected to the same network as your product, open a web browser.
4. Enter your product's IP address into the address bar.

You see the available Web Config utility options.

Parent topic: [Wired Networking](#)

Media Handling

See these sections to load and handle media on your product.

[Roll Paper Handling](#)

[Cut Sheet Handling](#)

[Creating Custom Paper Settings](#)

[Using the Paper Basket](#)

[Using the Auto Take-up Reel](#)

[Available Epson Papers](#)

[Borderless Paper Type Compatibility](#)

Roll Paper Handling

See these sections to load, cut, and remove roll paper in your product.

[Loading Roll Paper](#)

[Cutting Roll Paper](#)

[Removing Roll Paper](#)

Parent topic: [Media Handling](#)

Loading Roll Paper

You can load roll paper with a 2- or 3-inch core and a width of up to 24 inches (61 cm) [SureColor P7500 Series] or 44 inches (112 cm) [SureColor P9500 Series].

1. Open the roll paper cover.

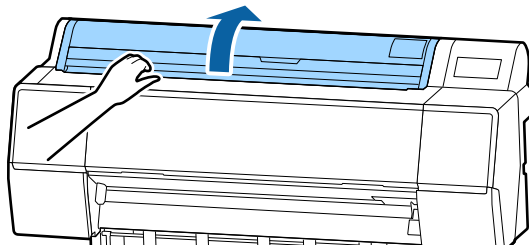

2. Firmly push down the lock lever on the roll paper holder.

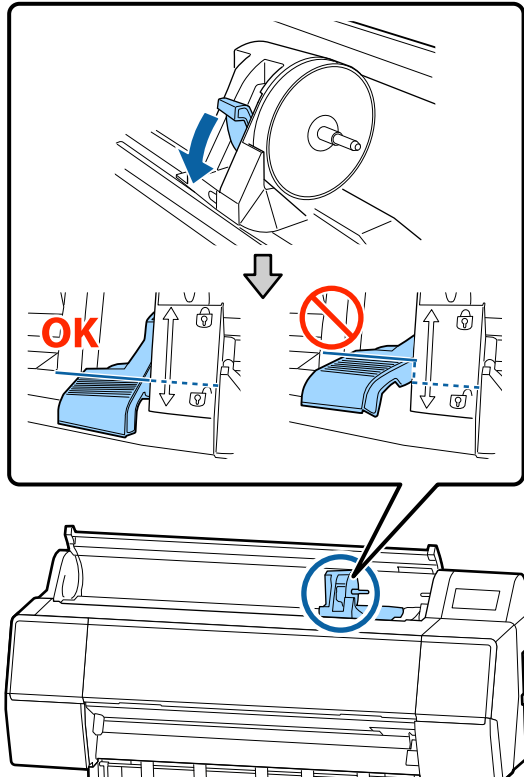

Note: Make sure you push the lock lever all the way down to unlock it completely.

3. Slide the roll paper holder to the left using the handle on the holder.

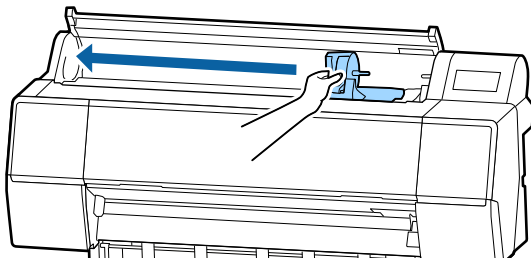

Note: Always use the handle when sliding the roll paper holder.

4. Place the roll paper on top of the printer with the leading edge of the paper on top of the roll, as shown.

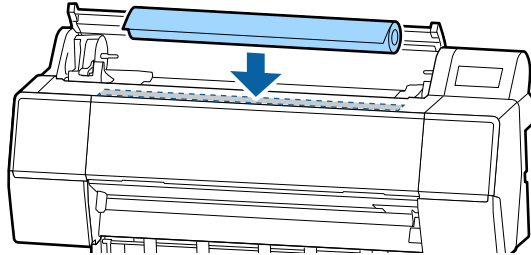

5. Slide the tabs on the roll media adapters to the position that matches the core size of the roll paper, if necessary.

2-inch core

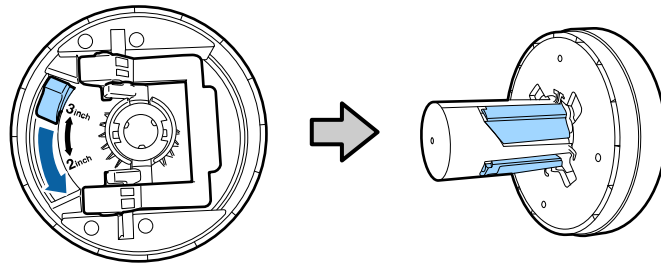

3-inch core

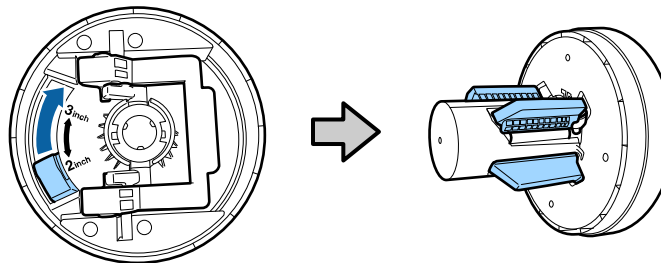

6. Release the tension levers on both roll media adapters as shown.

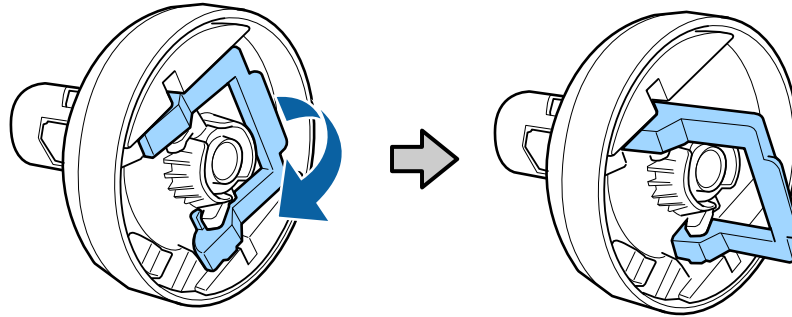

7. Push the adapters into the paper core at both ends of the roll. Then push down the tension levers.

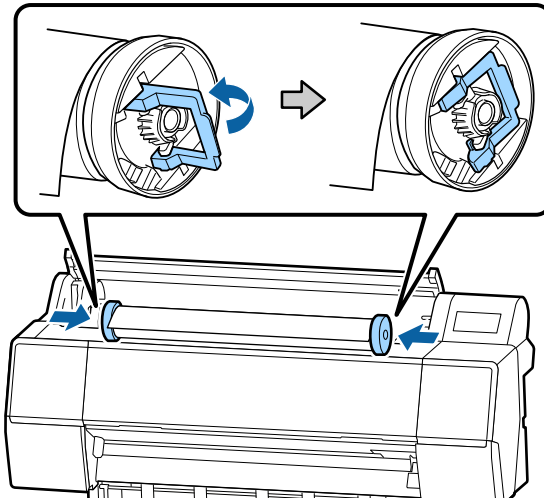

8. Move the roll paper to the right side of the printer until it touches the roll paper guide.

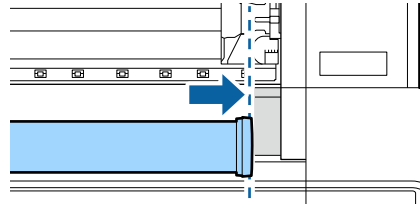

9. Slide the roll paper holder until the left roll paper adapter aligns with the arrow on the holder.

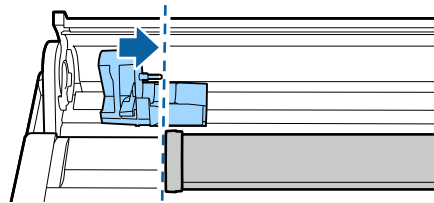

10. Roll the paper slowly into position between the roll paper holders.

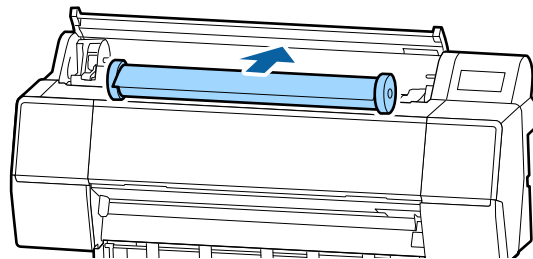

Caution: Rolling the roll paper with too much force may damage the printer or the roll paper adapters.

11. Slide the roll paper holder to the right to secure the roll paper in the printer. Make sure both ends of the roll paper are secured in the adapters.

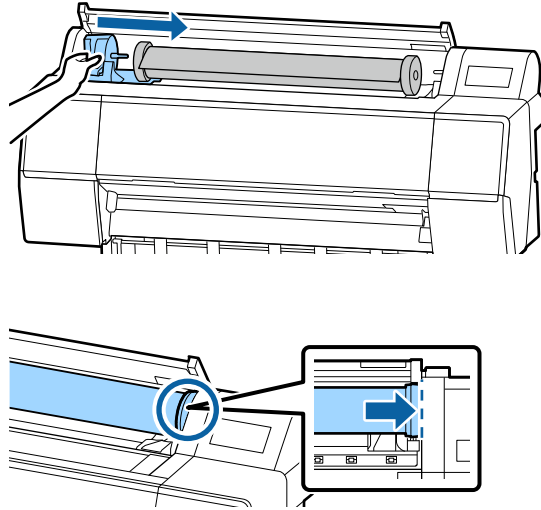

Note: Always use the handle when sliding the roll paper holder.

12. Pull up the lock lever on the roll paper holder to lock it in place.

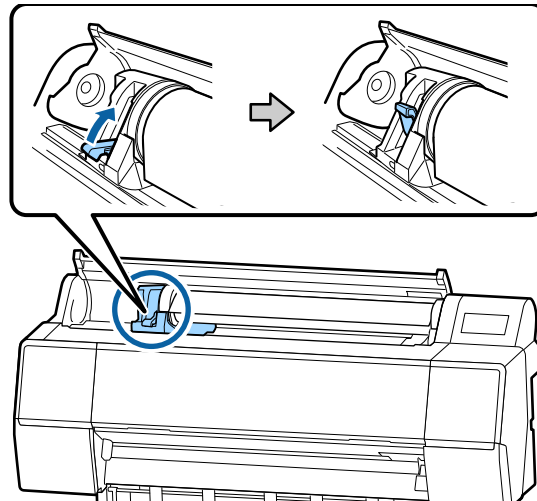

13. Press **Set** on the control panel to unlock the paper feed slot.
14. Insert the leading edge of the paper into the paper feed slot until you hear a sound.

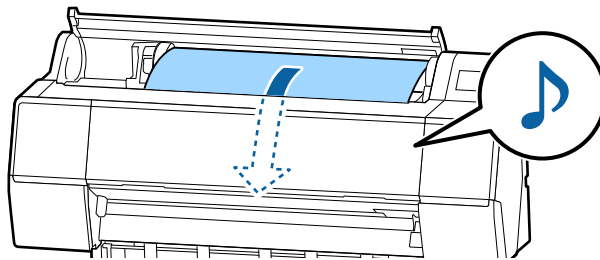
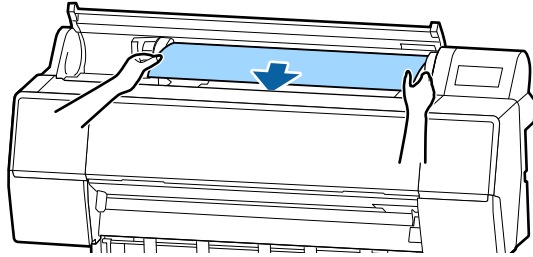

15. Make sure the roll paper is taut and the leading edge is not folded.

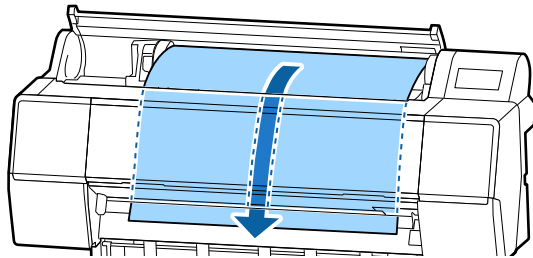

16. Close the roll paper cover.

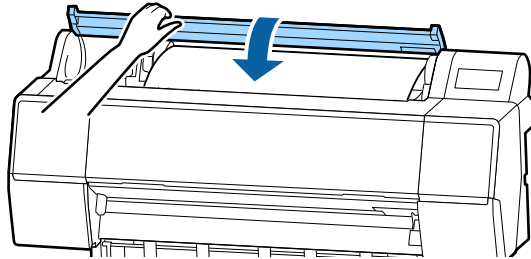

Note: To prevent dust from accumulating inside the printer, always keep the roll paper cover closed unless you are loading or unloading media.

17. On the LCD screen, select the paper type for the loaded paper.

Note: If the roll paper has a barcode printed on it, the printer reads it and automatically loads the correct settings.

18. If you want to track the amount of paper remaining on the roll, do the following:

- Select **Paper Remaining** and turn on **Remaining Amount Management**.
- Select **Remaining Amount** and enter the length of the roll paper.
- If you want to be notified when paper is low, select **Remaining Alert** and enter an amount.

Note: When you enable **Remaining Amount Management**, the printer prints a barcode on the leading edge of the roll when you remove the roll paper. When you reload the paper, the printer reads the barcode and automatically sets the paper type and amount remaining.

19. Select **Advanced Paper Settings** and set any additional settings, if necessary.

20. Select **OK** when you are finished.

Parent topic: [Roll Paper Handling](#)

Related references

[Paper Setting Menu](#)

Cutting Roll Paper

The printer has a built-in cutter that can automatically cut most paper types or you can cut your prints manually. To switch between cutting methods, select **Menu > General Settings > Printer Settings > Paper Source Settings > Roll Paper Setup > Cut Settings > Auto Cut** on the control panel or adjust the auto cut settings in the printer driver. The setting selected in the printer driver overrides the control panel setting.

Note: If you are using the optional Auto Take-up Reel, disable the auto cut setting in the printer driver and on the control panel.

Caution: Do not use the built-in cutter with these paper types or you may damage or dull the built-in cutter:

- Fine art paper
- Canvas
- Vinyl
- Matte poster board
- Adhesive paper
- Banner media

When you print on these paper types, you need to disable the Auto Cut setting and cut the print manually. You can print cutting guidelines to help you.

[Cutting Roll Paper Manually](#)

[Printing Cutting Guidelines](#)

Parent topic: [Roll Paper Handling](#)

Related topics

[Using the Auto Take-up Reel](#)

Cutting Roll Paper Manually

You can disable the Auto Cut option to keep your prints on the roll until you manually cut them using the built-in cutter.

1. With the front cover closed, select ✂ on the LCD screen and hold down either **Forward** or **Backwards** until the cut location reaches the cutting position labeled on the printer as shown.

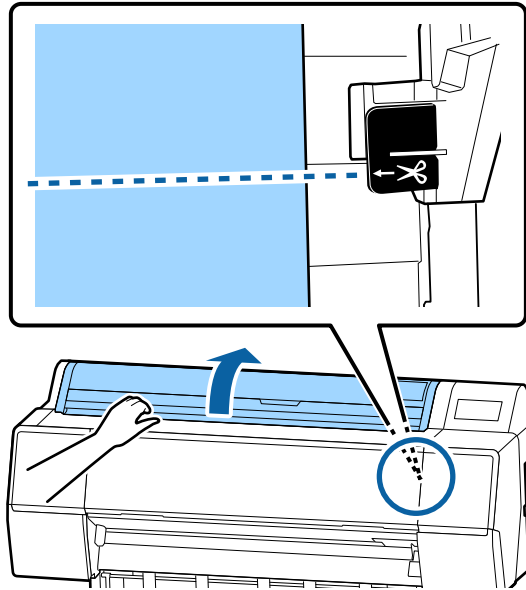

2. Select **Cut**.

You see a confirmation screen. Select **OK** to cut the paper.

Note: If the paper cannot be cut by the built-in cutter, select ✂ > **Forward** until your print is clear of the printer, then cut the print by hand.

Parent topic: [Cutting Roll Paper](#)

Printing Cutting Guidelines

When you disable the Auto Cut setting, you can print a cutting guideline between print jobs as a guide for manual cutting.

1. Press the  home button, if necessary.
2. Select **Menu > Printer Settings > Paper Source Settings > Roll Paper Setup > Cut Settings > Print Cutting Guidelines** and set it to **On**.

Parent topic: [Cutting Roll Paper](#)

Removing Roll Paper

When you finish printing on roll paper, remove it from the printer to avoid indenting or creasing the paper.

Note: If you enabled **Remaining Amount Management**, the printer prints a barcode on the leading edge of the roll when you remove the roll paper. When you reload the paper, the printer reads the barcode and automatically sets the paper type and amount remaining.

1. On the LCD screen, select the paper information area and select **Remove**.

The printer rewinds the roll paper.

Note: If printed paper is not cut and remains loaded in the printer, a confirmation screen appears. Select **Cut** to cut the paper at the default cut position or select **Print Cutting Guidelines** to print cut lines at the default position.

2. Open the roll paper cover.

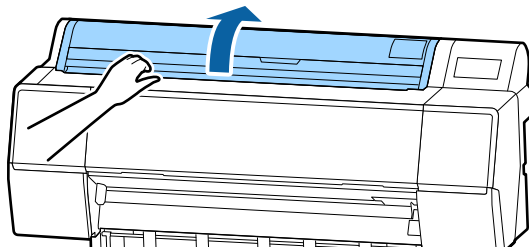

3. Firmly push down the lock lever on the roll paper holder to release it.

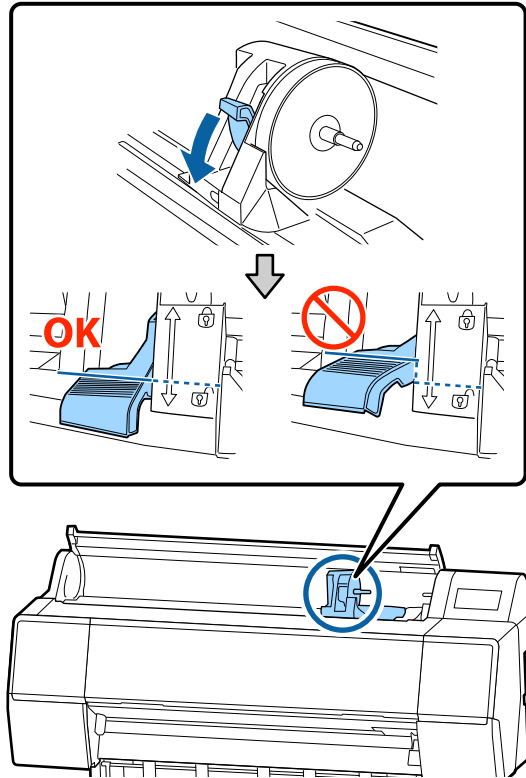

Note: Make sure you push the lock lever all the way down to unlock it completely.

4. Using the handle, slide the roll paper holder all the way to the left and remove it from the end of the roll.

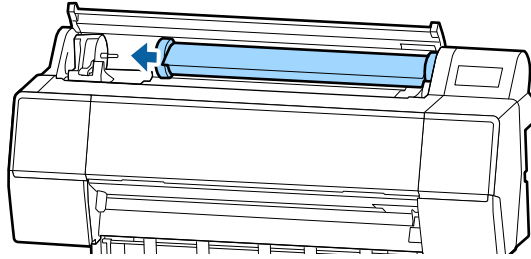

Note: Always use the handle when sliding the roll paper holder.

5. Roll the paper forward so that it rests on top of the printer.

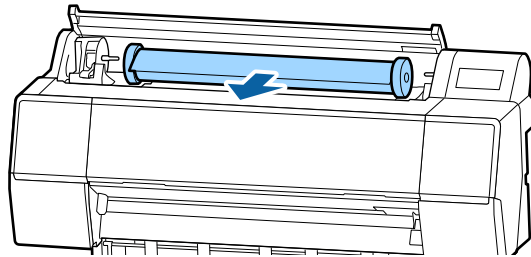

Caution: Rolling the roll paper with too much force may damage the printer or the roll paper adapters. If the roll paper adapters are damaged, you may not be able to roll the paper forward. If this occurs, lift the roll paper out of the printer to remove it.

6. Pull up the tension levers on the roll media adapters and remove the adapters from both ends of the paper roll.

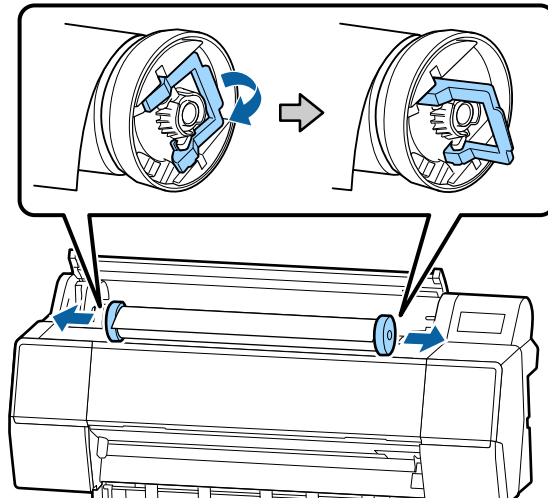

7. Rewind the paper carefully and place it in its original package.

Note: Store roll paper on its end or horizontally (if the packaging end-caps are installed). Never store roll paper on its edge, as a flat spot can develop and lead to imaging artifacts on the prints.

8. Raise the lock lever for the adapter holder to lock it in place.
9. Close the roll paper cover.

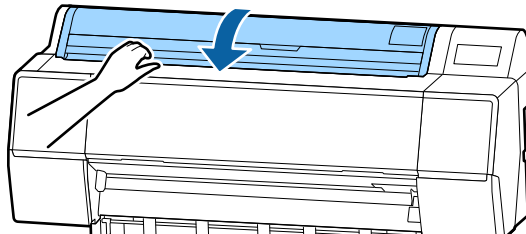

Note: To prevent dust from accumulating inside the printer, always keep the roll paper cover closed unless you are loading or unloading media.

Parent topic: [Roll Paper Handling](#)

Cut Sheet Handling

You can load a variety of types and sizes of cut sheet paper in your product.

[Loading Cut Sheets](#)

[Loading Thick or Large Cut Sheets \(Poster Board\)](#)

Parent topic: [Media Handling](#)

Loading Cut Sheets

Always load cut sheet paper in portrait orientation (short edge first). You can load most photo and fine art sheet papers up to .02 inches (0.5 mm) thick.

Note: Remove any loaded paper, including roll paper, before you load cut sheet paper or poster board.

1. Close the roll paper cover, if necessary.
2. Select the paper information area on the LCD screen.
3. Select **Cut Sheet**.
4. Open the cut sheet cover.

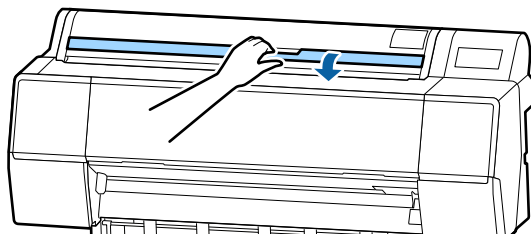

5. Feed the sheet into the right side of the paper feed slot until it meets resistance. Align the right edge of the sheet with the vertical line on the roll paper cover as shown. Make sure the printable side of the sheet is visible.

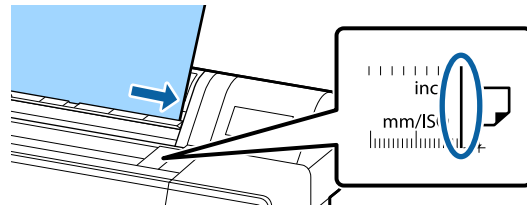
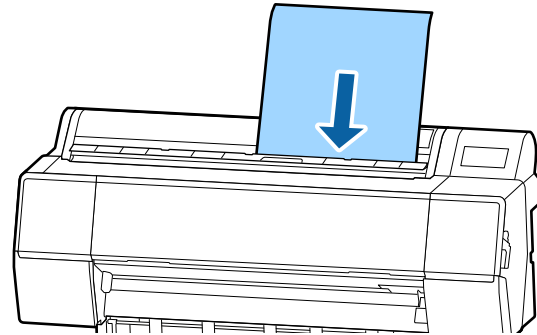

6. Select **Complete** > **OK** on the LCD screen.
7. Select a paper type and paper size that matches the loaded paper. If you need to adjust any specific settings, select **Advanced Paper Settings**.

Note: Store cut sheet media flat in its original packaging. Storing sheet media unprotected or on its long or short edge can lead to excess paper curl and cause damage to the printer and ruined prints.

8. To remove a cut sheet from the printer, support the paper so it doesn't fall, then select the paper information area on the LCD screen and select **Remove**.

Parent topic: [Cut Sheet Handling](#)

Related references

[Paper Setting Menu](#)

Related tasks

[Removing Roll Paper](#)

Loading Thick or Large Cut Sheets (Poster Board)

Load poster board of less than 30 inches (762 mm) long in portrait orientation (short edge first). You can load poster board from .02 to .06 inches (0.5 mm - 1.5 mm) thick.

Note: Remove any loaded paper, including roll paper, before you load cut sheet paper or poster board. You can load poster board with a length of up to 30 inches (762 mm). You can load poster board longer than 30 inches (762 mm) in the SureColor P9500 Series by loading the paper horizontally.

1. Close the roll paper cover, if necessary.
2. Select the paper information area on the LCD screen.
3. Select **Poster Board**.
4. Open the cut sheet cover.

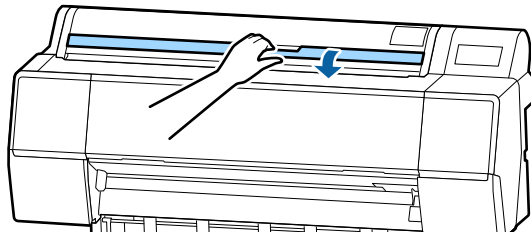

5. Feed the sheet into the right side of the paper feed slot until it meets resistance. Align the right edge of the sheet with the vertical line on the roll paper cover as shown. Make sure the printable side of the sheet is visible.

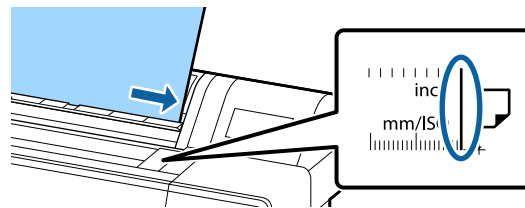
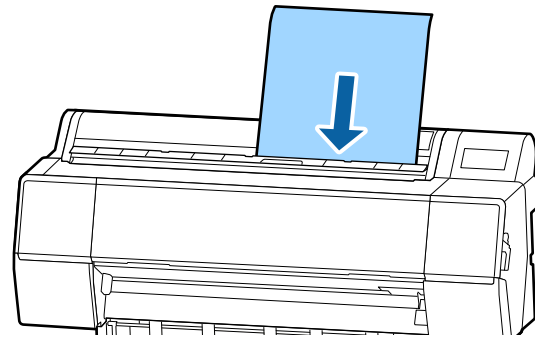

6. Insert the sheet until the trailing edge is below the loading mark on the roll paper cover (the top edge of the ruler).
7. Select **Complete** > **OK** on the LCD screen.
8. Select a media type that matches the loaded paper.

Note: Store cut sheet media flat in its original packaging. Storing sheet media unprotected or on its long or short edge can lead to excess paper curl and cause damage to the printer and ruined prints.

9. To remove a poster board from the printer, select the paper information area on the LCD screen and select **Remove**.

Parent topic: [Cut Sheet Handling](#)

Related references

[Paper Setting Menu](#)

Creating Custom Paper Settings

You can create and store up to 30 custom paper settings for use in printing on non-Epson paper or paper that is not supported by the Epson printer driver.

1. Load the type of paper that you want to configure in the printer.
2. Select **Menu > General Settings > Printer Settings > Custom Paper Setting**.
3. Select a number for the custom paper setting.

Note: You cannot change paper setting information registered using the printer driver or other software using the LCD screen.

4. Select **Change Reference Paper**.
5. Select a paper preset that is similar to the paper that you loaded following these guidelines:
 - Photo paper: **Baryta**
 - Glossy paper: **Photo Paper** or **Proofing Paper**
 - Thick, non-glossy paper: **Matte Paper**
 - Thin, soft, non-glossy paper: **Plain Paper**
 - Cotton paper with a rough surface: **Fine Art Paper**
 - Special media such as film, cloth, poster board, or tracing paper: **Others**
6. Select **Advanced Paper Settings** and enter a value for the following settings:
 - **Paper Thickness**
 - **Roll Core Diameter** (roll paper only)
 - **Paper Feed Offset** (leave at 0 unless you see horizontal banding)
7. Select any additional settings in the Advanced Paper Settings menu, as necessary.

After you create a new custom paper setting, it will appear in the list of available paper types.

Note: You can also use Epson Media Installer to create custom paper settings.

[Creating Custom Paper Settings Using Epson Media Installer](#)
[Downloading Epson Media Settings](#)

Parent topic: [Media Handling](#)

Creating Custom Paper Settings Using Epson Media Installer

You can create and store up to 30 custom paper settings for use in printing on non-Epson paper or paper that is not supported by the Epson printer driver. You create custom paper settings by copying an existing paper setting, renaming it, and assigning an ICC profile.

Note: You will need an ICC profile to assign to the paper setting. You cannot change custom paper settings created through Epson Media Installer using the printer control panel.

Note: On Mac, Epson Media Installer requires OS X 10.9.x or later to be installed.

1. Open the Epson Media Installer software.
 - **Windows:** Open the printer driver by right-clicking the icon for your product in the right side of the Windows taskbar, or click the up arrow and right-click the printer icon, then selecting **Printer Settings**.
Select the **Utility** tab and click **Epson Media Installer**.
 - **Mac:** Open the **Applications > Epson Software > Epson Utilities** folder and double-click **Epson Media Installer**.
2. Click **Media Management**, if necessary.

You see a screen like this:

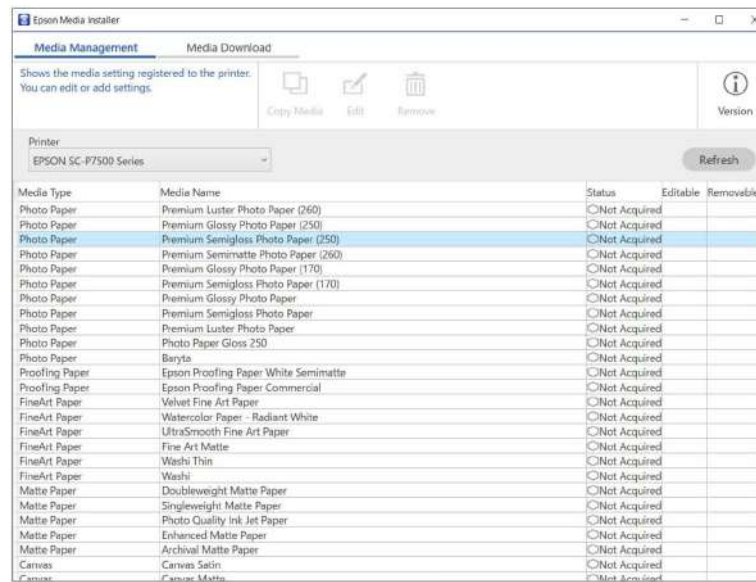

3. Select the paper type you want to use as a base for the new paper setting and click **Copy Media**.
4. Select the new paper setting and click **Edit**.
5. Enter a new name and click **Browse** to load an ICC profile file to use for the paper setting.
6. Click **OK** and confirm that you want to add the new paper setting to the driver and printer.

Note: The new paper type will be assigned as the next open custom paper setting on the printer. There is a limit of 30 custom paper settings.

The new setting is available in your printer driver and on the printer control panel.

Parent topic: [Creating Custom Paper Settings](#)

Downloading Epson Media Settings

You can download new or updated media settings for Epson media using the Epson Media Installer utility.

Note: To install media settings on the printer, you must be connected to the printer.

Note: On Mac, Epson Media Installer requires OS X 10.9.x or later to be installed.

1. Open the Epson Media Installer software.

- **Windows:** Open the printer driver by right-clicking the icon for your product in the right side of the Windows taskbar, or click the up arrow and right-click the printer icon, then selecting **Printer Settings**.

Select the **Utility** tab and click **Epson Media Installer**.

- **Mac:** Open the **Applications > Epson Software > Epson Utilities** folder and double-click **Epson Media Installer**.

2. Click **Media Download**, if necessary.

You see a screen like this:

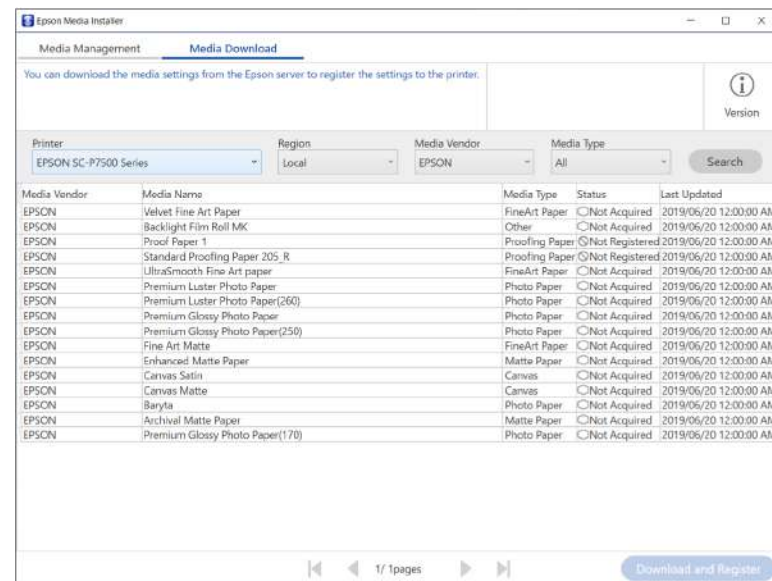

3. Click the name of the media settings you want to download and click **Download and Register**.

The new settings are available in your printer driver and on the printer control panel.

Note: If you are using the optional Adobe Postscript 3 print server, make sure that the custom paper settings on the print server match the custom paper settings on the printer. If the settings do not match, colors may not print correctly.

Parent topic: [Creating Custom Paper Settings](#)

Using the Paper Basket

The paper basket catches printouts and keeps them from getting dirty or scratched. You can set up the basket to catch paper under the printer or in front of the printer.

Caution: For fine art and other sensitive prints, do not allow media to stack in the paper basket or they may be damaged.

[Catching Printouts Under the Product](#)

[Catching Printouts in Front of the Product](#)

[Storing the Paper Basket](#)

Parent topic: [Media Handling](#)

Catching Printouts Under the Product

You can configure the paper basket to catch printouts under the product.

1. Raise the paper guides.

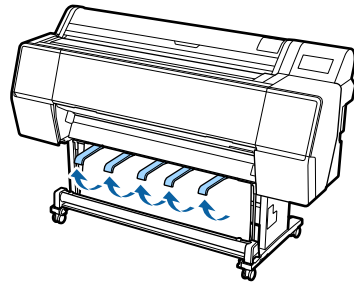

Note: The SureColor P7500 Series printer has two paper guides; the SureColor P9500 Series has five.

2. Lower the support arms of the paper basket until they touch the rolled basket canvas.

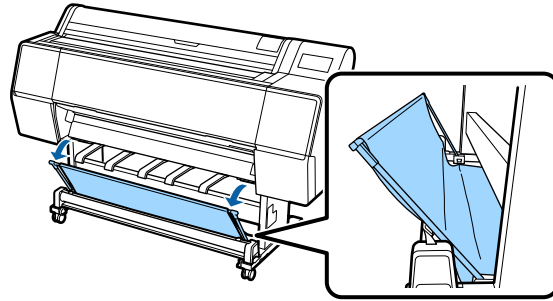

3. Gently squeeze the tops of the paper guides to release them and lower them until they are vertical.

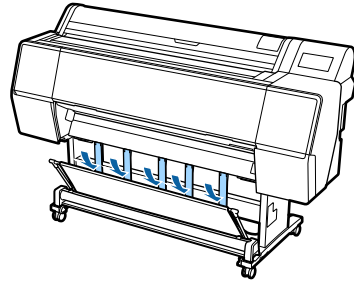

4. Raise the support arms on the paper basket back to their original position.

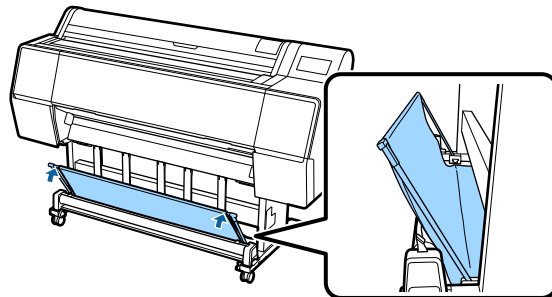

Parent topic: [Using the Paper Basket](#)

Catching Printouts in Front of the Product

You can configure the paper basket to catch printouts in the front the product. You should remove prints as they are ejected. Allowing prints to pile up in the paper basket may damage the prints or cause prints to be ejected incorrectly.

1. Make sure the paper guides lay on top of the paper basket as shown below:

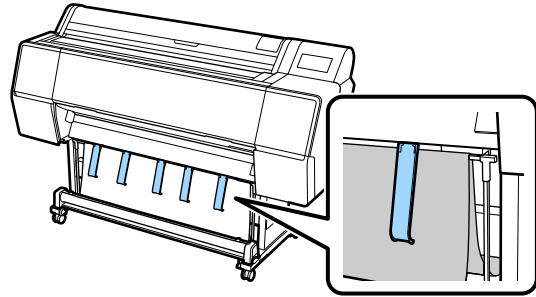

Note: The SureColor P7500 Series printer has two paper guides; the SureColor P9500 Series has five.

2. Hold the basket roll with two hands and pull it straight down. Adjust the length of the basket cloth based on the length of the intended print.

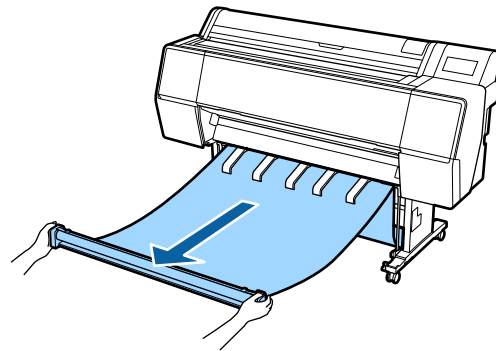

3. Place the basket roll so that the basket cloth does not touch the ground.

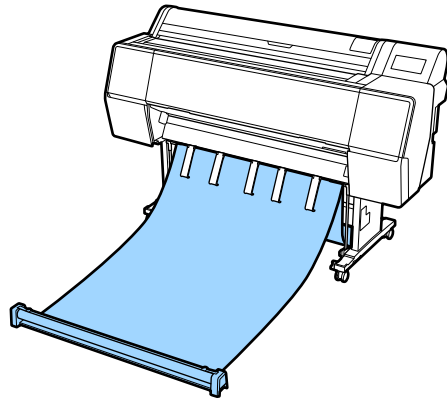

Note: If the cloth is stretched too tightly or resting on the floor, paper may not eject correctly.

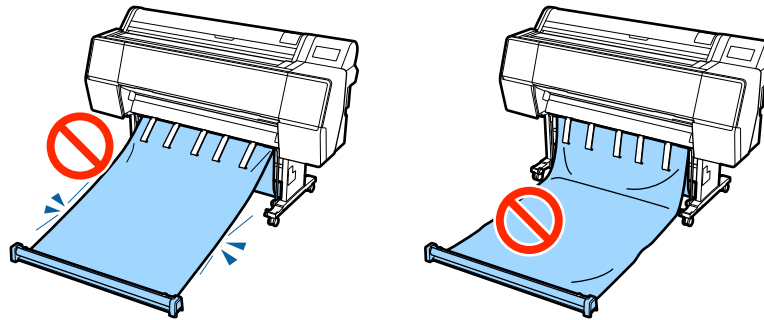

4. To adjust the angle of the basket, adjust the length of the straps on the left and right of the basket.
- For a steeper angle, shorten the straps by attaching the loops that are closer to the basket to the hook on the stand.

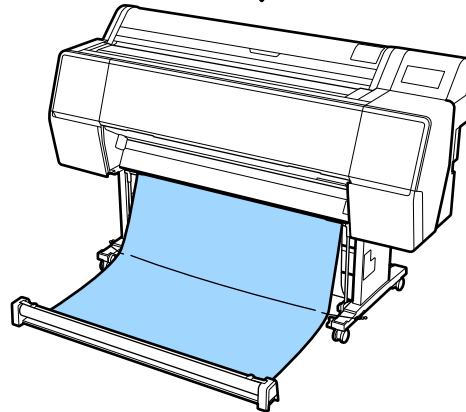
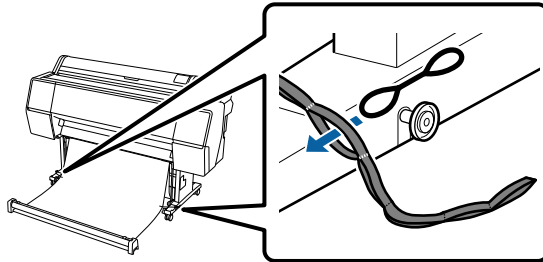

- For a shallower angle, lengthen the straps by attaching the loops that are closer to the end of the strap to the hook on the stand.

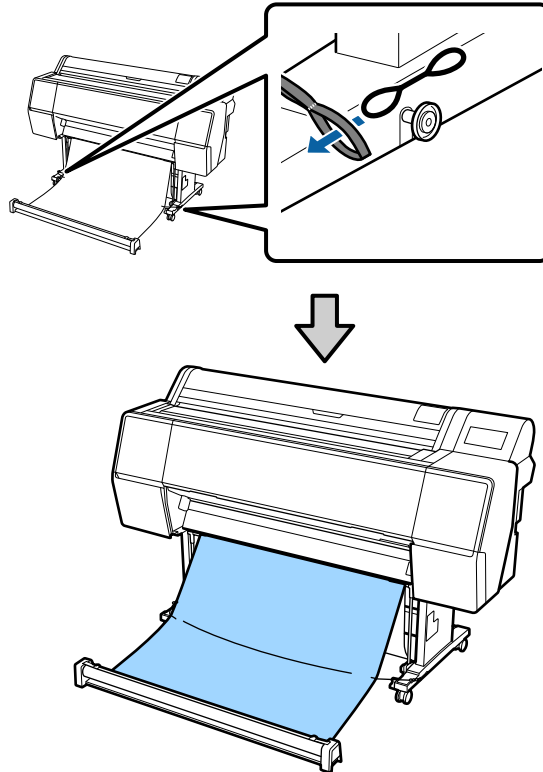

Note: If the paper curls too much when it is cut automatically, turn off the **Auto Cut** feature.

Parent topic: [Using the Paper Basket](#)

Related topics

[Cutting Roll Paper](#)

Storing the Paper Basket

You should store the paper basket whenever you do the following:

- You are not using the basket

- You are loading paper
 - You are moving the printer
1. Lift the basket roll.

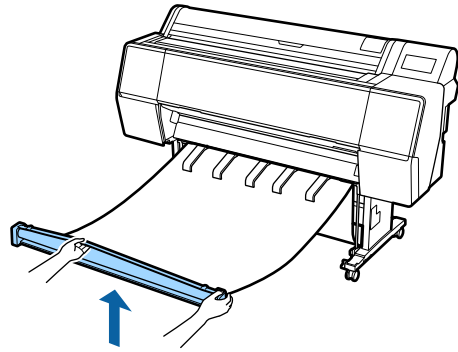

2. While holding the button on the right hand side of the basket roll, move the basket towards the printer to take up the cloth. You can wind the cloth evenly by feeding the bottom of the cloth over the frame.

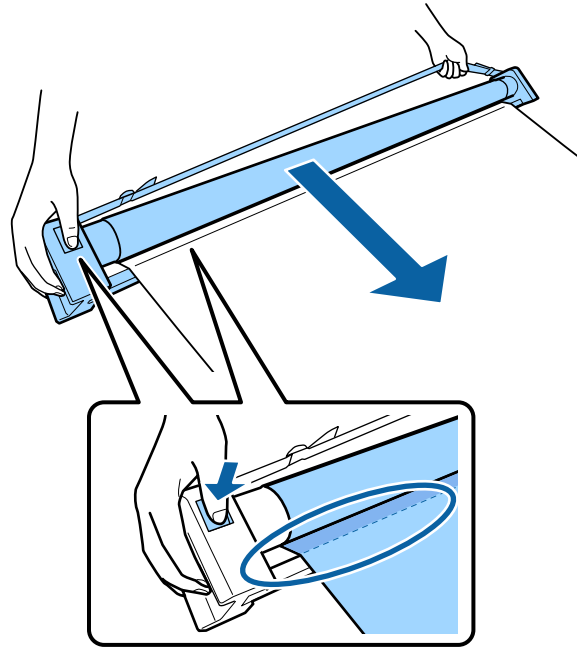

Note: The hand strap for the paper basket is only available on the SureColor P9500 Series. Hold the paper basket by the ends when lifting and moving the basket.

3. Place the basket roll on the front legs of the stand.

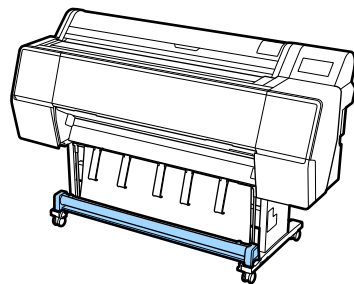

4. Slightly rotate the basket roll counter-clockwise to release tension on the roll and prevent stretching.

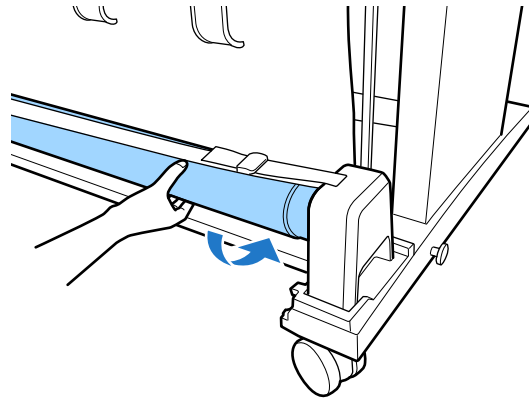

5. If there are wrinkles in the cloth, smooth it as shown to prevent it from becoming deformed during storage.

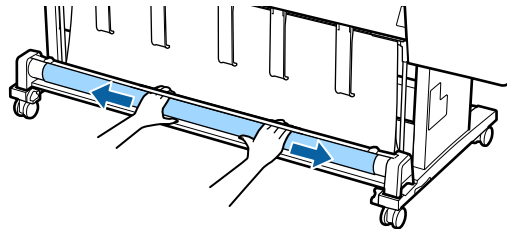

Parent topic: [Using the Paper Basket](#)

Using the Auto Take-up Reel

See these sections to use the auto take-up reel with your product.

[About the Optional Auto Take-up Reel](#)

[Take Up with the Printable Side In](#)

[Take Up with the Printable Side Out](#)

[Removing Media from the Optional Auto Take-up Reel](#)

Parent topic: [Media Handling](#)

Related topics

[Cutting Roll Paper](#)

About the Optional Auto Take-up Reel

The optional auto take-up reel automatically rolls up printed media as you print.

You can use the auto take-up reel for media with the printable side in (on the left) or printable side out (on the right).

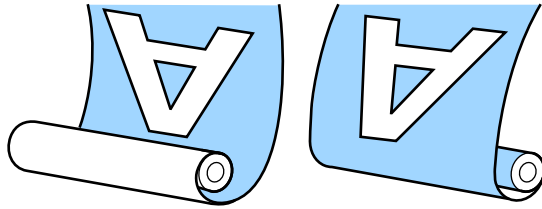

It is best to do the following when using the auto take-up reel:

- Make sure that the end of the roll is cut straight across.
- Load media with the printable side in.
- Use a take-up roll core that is the same width as your media so the core does not bend or take up media incorrectly.

Caution: Make sure you fix the roll core in place as described in the documentation and make sure your hair, hands, or other objects do not get caught in the moving parts of the auto take-up reel, or injury may occur.

Parent topic: [Using the Auto Take-up Reel](#)

Take Up with the Printable Side In

After you attach the roll core on the Auto Take-up Reel as described in the documentation that came with the Auto Take-up Reel, follow these steps to take up media with the printable side in.

Note: Make sure **Auto Cut** is set to **Off** when you use the Auto Take-up Reel.

1. Move the **Auto** switch on the take-up reel to the **Off** position and plug in the power cable.

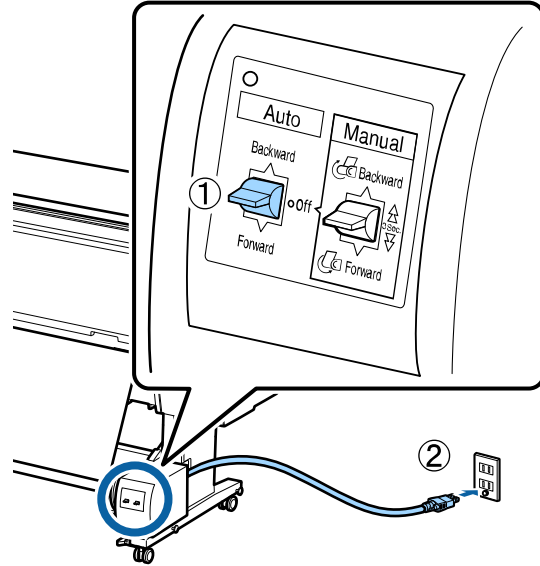

2. Turn on the printer.
3. Load roll media in the printer.
4. Select the paper information area on the LCD screen and select **Prepare for Take-up**.
5. Wind the edge of the media around the back of the roll core.

6. Tape the edge of the media to the center of the core, then tape the edge to the left and right ends.

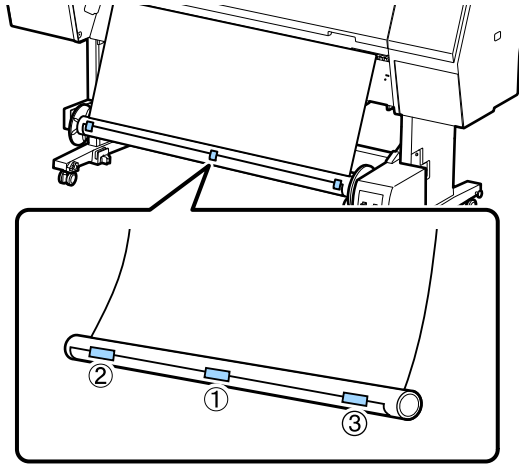

7. Select  and hold down **Forward** on the LCD screen until it feeds enough media to wrap around the roll core three times.

8. Move the **Manual** switch on the take-up reel to the **Backward** position and hold it until the media wraps around the core three times.

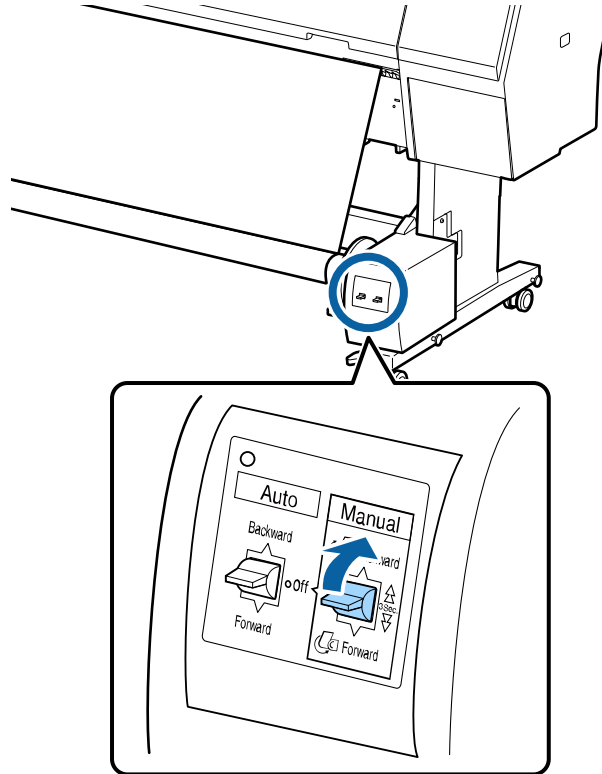

9. Make sure that there is some slack in the media and that it loads evenly on both sides.

Note: The media will not take up correctly if it is looser on one side than the other.

10. Move the **Auto** switch on the take-up reel to the **Backward** position.

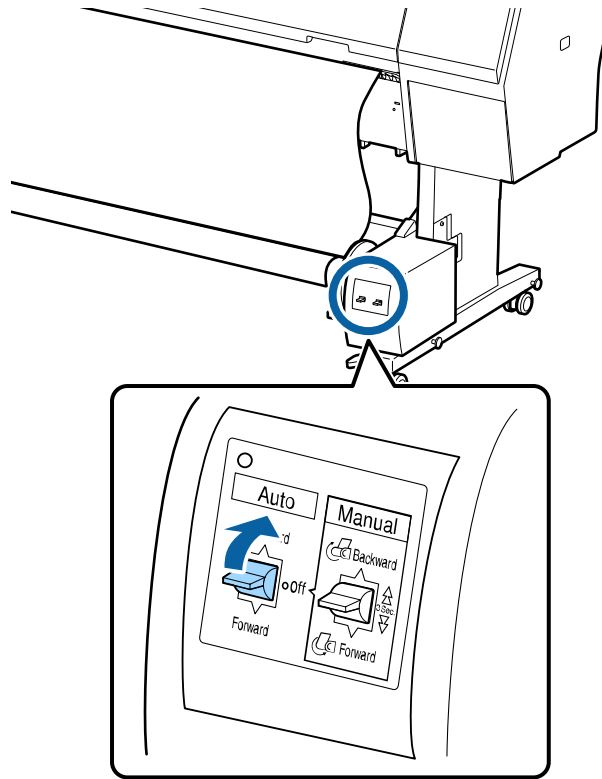

Parent topic: [Using the Auto Take-up Reel](#)

Related tasks

[Loading Roll Paper](#)

Take Up with the Printable Side Out

After you attach the roll core on the Auto Take-up Reel as described in the documentation that came with the Auto Take-up Reel, follow these steps to take up media with the printable side out.

Note: Make sure **Auto Cut** is set to **Off** when you use the Auto Take-up Reel.

1. Move the **Auto** switch on the take-up reel to the **Off** position and plug in the power cable.

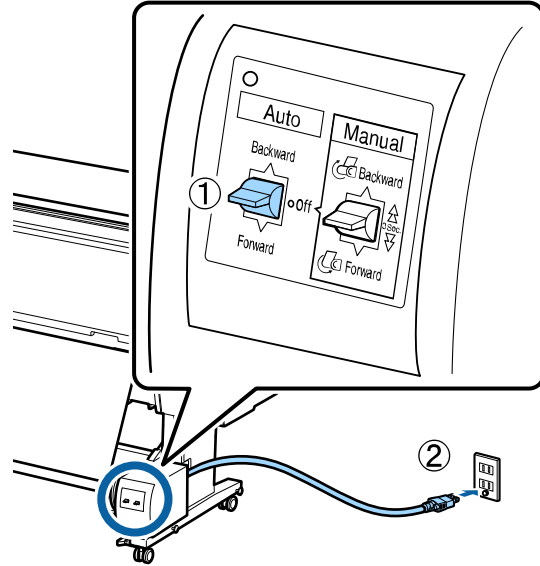

2. Turn on the printer.
3. Load roll media in the printer.
4. Select the paper information area on the LCD screen and select **Prepare for Take-up**.

5. Tape the edge of the media to the center of the core, then tape the edge to the left and right ends.

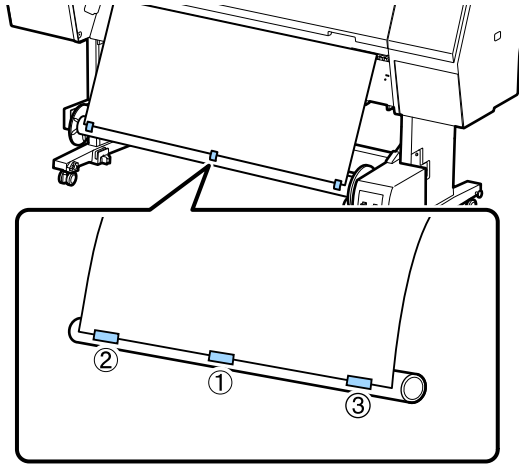

6. Select  and hold down **Forward** on the LCD screen until it feeds enough media to wrap around the roll core three times.

7. Move the **Manual** switch on the take-up reel to the **Forward** position and hold it until the media wraps around the core three times.

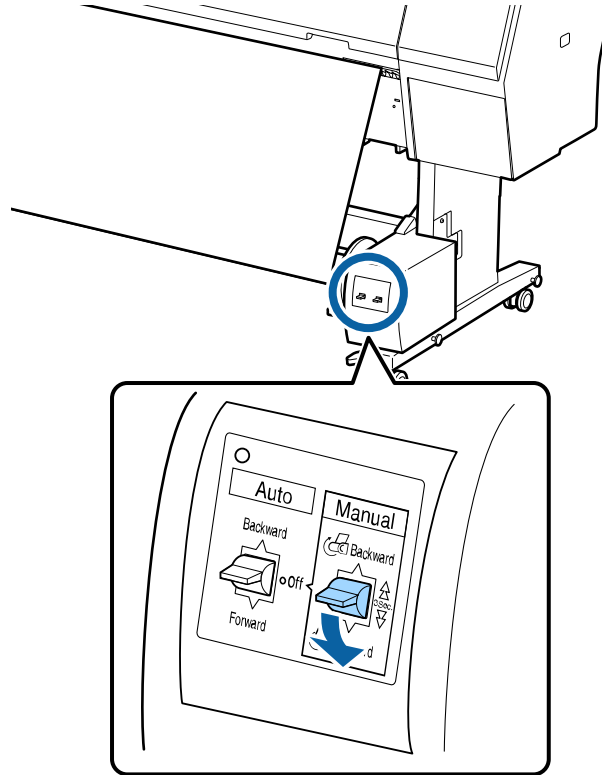

8. Make sure that there is some slack in the media and that it loads evenly on both sides.

Note: The media will not take up correctly if it is looser on one side than the other.

If you are printing on Epson Singleweight Matte Paper, place the tensioner that came with the Auto Take-up Reel in the slack of the roll.

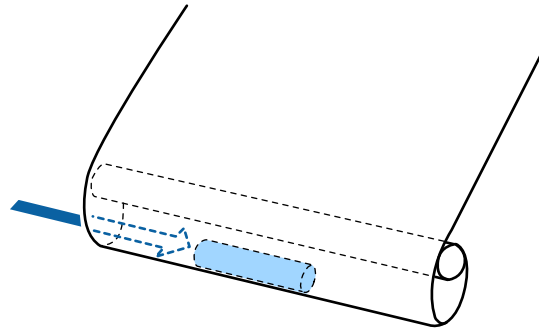

9. Move the **Auto** switch on the take-up reel to the **Forward** position.

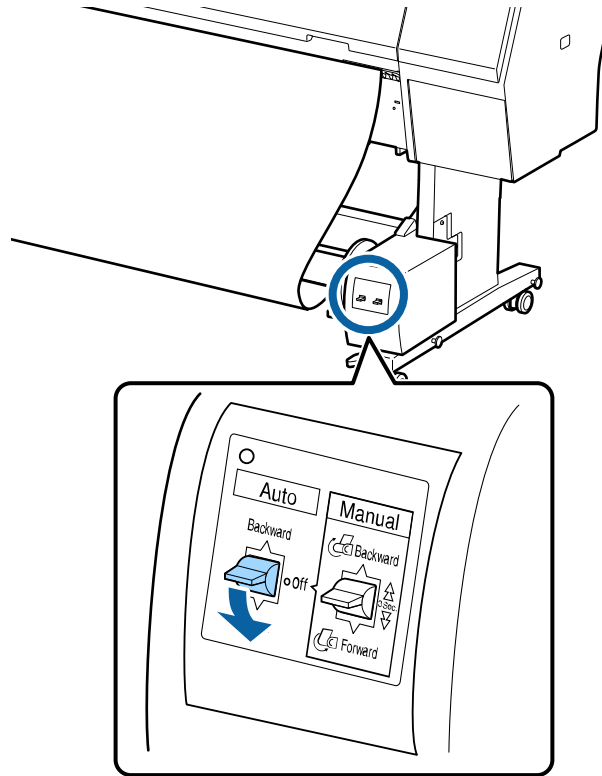

Parent topic: [Using the Auto Take-up Reel](#)

Related tasks

[Loading Roll Paper](#)

Removing Media from the Optional Auto Take-up Reel

After printing on media loaded on the Optional Auto Take-up Reel, follow these steps to remove it.

Note: Two people are required to remove media from the take-up reel.

1. Move the **Auto** switch on the take-up reel to the **Off** position.

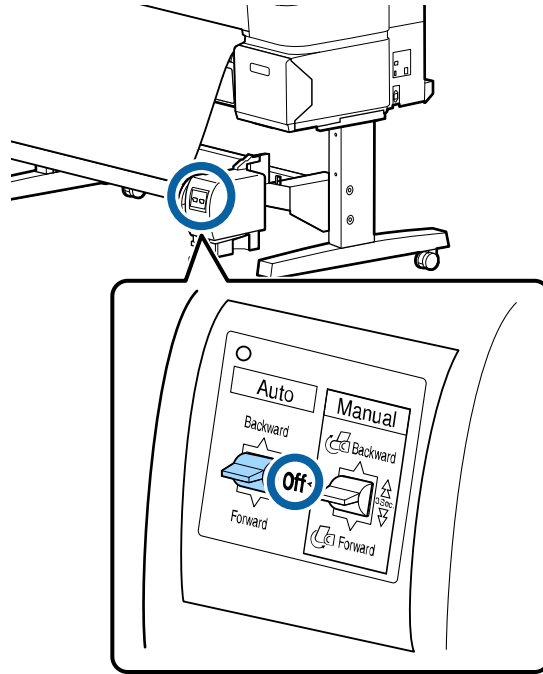

2. Cut the media and roll the cut end onto the take-up reel manually.

3. Turn the lever shown here to unlock the take-up reel, then slide the paper holder off the left end of the roll.

Note: Support the reel with one hand to keep it from falling.

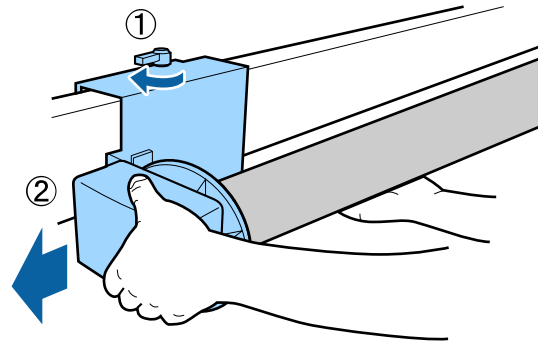

4. Remove the roll core from the take-up reel.

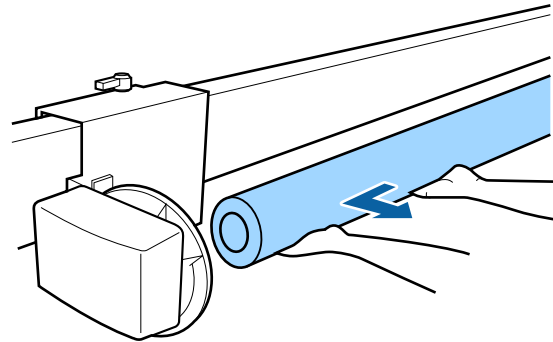

Parent topic: [Using the Auto Take-up Reel](#)

Available Epson Papers

You can purchase genuine Epson ink, paper, and accessories from an Epson authorized reseller. To find the nearest reseller, visit proimaging.epson.com (U.S.) or proimaging.epson.ca (Canada), select your product series and product, and click the **Where to Buy** button. Or call 800-GO-EPSON (800-463-7766) in the U.S. or 800-807-7766 in Canada.

Note: Paper/media availability varies by country.

Note: For the most updated list of supported Epson papers, visit proimaging.epson.com (U.S.) or proimaging.epson.ca (Canada).

Paper Type	Size	Part number	Sheet count
Epson Cold Press Bright	Letter (8.5 × 11 inches [216 × 279 mm])	S042307	25
	13 × 19 inches (330 × 483 mm)	S042310	25
	17 × 22 inches (432 × 559 mm)	S042311	25
	17 inches (432 mm) × 50 feet (15.2 m)	S042313	1 roll
	24 inches (610 mm) × 50 feet (15.3 m)	S042314	1 roll
	44 inches (1118 mm) × 50 feet (15.3 m)*	S042315	1 roll
Epson Cold Press Natural	Letter (8.5 × 11 inches [216 × 279 mm])	S042297	25
	13 × 19 inches (330 × 483 mm)	S042300	25
	17 × 22 inches (432 × 559 mm)	S042301	25
	17 inches (432 mm) × 50 feet (15.2 m)	S042303	1 roll
	24 inches (610 mm) × 50 feet (15.3 m)	S042304	1 roll
	44 inches (1118 mm) × 50 feet (15.3 m)*	S042305	1 roll
Epson Velvet Fine Art Paper	Letter (8.5 × 11 inches [216 × 279 mm])	S041636	20
	13 × 19 inches (330 × 483 mm)	S041637	20
	17 × 22 inches (432 × 559 mm)	S042097	25

Paper Type	Size	Part number	Sheet count
Epson Exhibition Fiber Paper	Letter (8.5 × 11 inches [216 × 279 mm])	S045033	25
	13 × 19 inches (330 × 483 mm)	S045037	25
	17 × 22 inches (432 × 559 mm)	S045039	25
Epson Hot Press Bright	Letter (8.5 × 11 inches [216 × 279 mm])	S042327	25
	13 × 19 inches (330 × 483 mm)	S042330	25
	17 × 22 inches (432 × 559 mm)	S042331	25
	17 inches (432 mm) × 50 feet (15.2 m)	S042333	1 roll
	24 inches (610 mm) × 50 feet (15.3 m)	S042334	1 roll
	44 inches (1118 mm) × 50 feet (15.3 m)*	S042335	1 roll
Epson Hot Press Natural	Letter (8.5 × 11 inches [216 × 279 mm])	S042317	25
	13 × 19 inches (330 × 483 mm)	S042320	25
	17 × 22 inches (432 × 559 mm)	S042321	25
	17 inches (432 mm) × 50 feet (15.2 m)	S042323	1 roll
	24 inches (610 mm) × 50 feet (15.3 m)	S042324	1 roll
	44 inches (1118 mm) × 50 feet (15.3 m)*	S042325	1 roll
Epson Ultra Premium Photo Paper Glossy	Letter (8.5 × 11 inches [216 × 279 mm])	S042175	20
	8 × 10 inches (203 × 254 mm)	S041946	20

Paper Type	Size	Part number	Sheet count
Epson Premium Luster Photo Paper (260)	8.3 inches (211 mm) × 32 feet (9.8 m)	S041408	1 roll
	13 inches (330 mm) × 32 feet (9.8 m)	S041409	1 roll
	10 inches (254 mm) × 100 feet (30.5 m)	S042077	1 roll
	16 inches (406 mm) × 100 feet (30.5 m)	S042079	1 roll
	24 inches (610 mm) × 100 feet (30.5 m)	S042081	1 roll
	36 inches (914 mm) × 100 feet (30.5 m)*	S042082	1 roll
	44 inches (1118 mm) × 100 feet (30.5 m)*	S042083	1 roll
Epson Metallic Photo Paper Glossy	16 inches (406 mm) × 100 feet (30.5 m)	S045585	1 roll
	24 inches (610 mm) × 100 feet (30.5 m)	S045586	1 roll
	36 inches (914 mm) × 100 feet (30.5 m)*	S045587	1 roll
	44 inches (1118 mm) × 100 feet (30.5 m)*	S045588	1 roll
	Letter (8.5 × 11 inches [216 × 279 mm])	S045589	25
	13 × 19 inches (330 × 483 mm)	S045590	25
	17 × 22 inches (432 × 559 mm)	S045591	25

Paper Type	Size	Part number	Sheet count
Epson Metallic Photo Paper Luster	16 inches (406 mm) × 100 feet (30.5 m)	S045592	1 roll
	24 inches (610 mm) × 100 feet (30.5 m)	S045593	1 roll
	36 inches (914 mm) × 100 feet (30.5 m)*	S045594	1 roll
	44 inches (1118 mm) × 100 feet (30.5 m)*	S045595	1 roll
	Letter (8.5 × 11 inches [216 × 279 mm])	S045516	25
	13 × 19 inches (330 × 483 mm)	S045517	25
	17 × 22 inches (432 × 559 mm)	S045598	25
Epson Photo Paper Glossy	Letter (8.5 × 11 inches [216 × 279 mm])	S041649	50
	11 × 17 inches (279 × 432 mm)	S041156	20
	13 × 19 inches (330 × 483 mm)	S041143	20
	Letter (8.5 × 11 inches [216 × 279 mm])	S041271	100

Paper Type	Size	Part number	Sheet count
Epson Premium Photo Paper Glossy	Letter (8.5 × 11 inches [216 × 279 mm])	S041286	20
	A3 (11.7 × 16.5 inches [297 × 420 mm])	S041288	20
	13 × 19 inches (330 × 483 mm)	S041289	20
	Letter (8.5 × 11 inches [216 × 279 mm])	S041667	50
	11 × 17 inches (279 × 432 mm)	S041290	20
	4 × 6 inches (102 × 152 mm)	S041727	100
	5 × 7 inches (127 × 178 mm)	S041464	20
	8 × 10 inches (203 × 254 mm)	S041465	20
	11 × 14 inches (279 × 356 mm)	S041466	20
17 × 22 inches (432 × 559 mm)	S042092	25	
Epson Premium Photo Paper Semi-gloss	Letter (8.5 × 11 inches [216 × 279 mm])	S041331	20
	13 × 19 inches (330 × 483 mm)	S041327	20
	8 × 10 inches (203 × 254 mm)	S041467	50
	Letter (8.5 × 11 inches [216 × 279 mm])	S041257	50
	11 × 14 inches (279 × 356 mm)	S041468	50
	A3 (11.7 × 16.5 inches [297 × 420 mm])	S041260	50
	13 × 19 inches (330 × 483 mm)	S041263	50
	17 × 22 inches (432 × 559 mm)	S042124	25

Paper Type	Size	Part number	Sheet count
Epson Premium Presentation Paper Matte	Letter (8.5 × 11 inches [216 × 279 mm])	S041062	100
	Legal (8.5 × 14 inches [216 × 356 mm])	S041067	100
	11 × 17 inches (279 × 432 mm)	S041070	100
	13 × 19 inches (330 × 483 mm)	S041069	100
	16.5 × 23.4 inches (420 × 594 mm)	S041079	30
	17 × 22 inches (432 × 559 mm)	S041171	100
Epson Proofing Paper White Semimatte	13 × 19 inches (330 × 483 mm)	S045115	100
	13 inches (300 mm) × 100 feet (30.5 m)	S042002	1 roll
	17 inches (432 mm) × 100 feet (30.5 m)	S042003	1 roll
	24 inches (610 mm) × 100 feet (30.5 m)	S042004	1 roll
	36 inches (914 mm) × 100 feet (30.5 m)*	S042005	1 roll
	44 inches (1118 mm) × 100 feet (30.5 m)*	S042006	1 roll
Epson Standard Proofing Paper Publication	13 inches (300 mm) × 100 feet (30.5 m)	S041996	1 roll
	17 inches (432 mm) × 100 feet (30.5 m)	S041997	1 roll
	24 inches (610 mm) × 100 feet (30.5 m)	S041998	1 roll
	36 inches (914 mm) × 100 feet (30.5 m)*	S041999	1 roll
	44 inches (1118 mm) × 100 feet (30.5 m)*	S042001	1 roll

Paper Type	Size	Part number	Sheet count
Epson Standard Proofing Paper Commercial	13 inches (300 mm) × 100 feet (30.5 m)	S042144	1 roll
	17 inches (432 mm) × 100 feet (30.5 m)	S041997	1 roll
	24 inches (610 mm) × 100 feet (30.5 m)	S041998	1 roll
	36 inches (914 mm) × 100 feet (30.5 m)*	S041999	1 roll
	44 inches (1118 mm) × 100 feet (30.5 m)*	S042001	1 roll
Epson Standard Proofing Paper (240)	13 × 19 inches (330 × 483 mm)	S045115	100
Epson Ultra Premium Photo Paper Luster	Letter (8.5 × 11 inches [216 × 279 mm])	S041405	50
	A3 (11.7 × 16.5 inches [297 × 420 mm])	S041406	50
	13 × 19 inches (330 × 483 mm)	S041407	50
	13 × 19 inches (330 × 483 mm)	S041604	100
	17 × 22 inches (432 × 559 mm)	S042084	25
	13 inches (330 mm) × 32.8 feet (10 m)	S041409	1 roll
Epson Ultra Premium Presentation Paper Matte	Letter (8.5 × 11 inches [216 × 279 mm])	S041341	50
	A3 (11.7 × 16.5 inches [297 × 420 mm])	S041343	50
	13 × 19 inches (330 × 483 mm)	S041339	50
	13 × 19 inches (330 × 483 mm)	S041605	100
	17 × 22 inches (432 × 559 mm)	S041908	100
Epson UltraSmooth Fine Art Paper	13 × 19 inches (330 × 483 mm)	S041896	25
	17 × 22 inches (432 × 559 mm)	S041897	25

Paper Type	Size	Part number	Sheet count
Epson Watercolor Paper Radiant White	13 × 19 inches (330 × 483 mm)	S041351	20
Epson Exhibition Canvas Matte	17 × 22 inches (432 × 559 mm)	S045261	25
	13 inches (330 mm) × 20 feet (6.1 m)	S045255	1 roll
	17 inches (432 mm) × 40 feet (12.2 m)	S045256	1 roll
	24 inches (610 mm) × 40 feet (12.2 m)	S045257	1 roll
	36 inches (914 mm) × 40 feet (12.2 m)*	S045258	1 roll
	44 inches (1118 mm) × 40 feet (12.2 m)*	S045259	1 roll
Epson Exhibition Canvas Satin	13 inches (330 mm) × 20 feet (6.1 m)	S045248	1 roll
	17 inches (432 mm) × 40 feet (12.2 m)	S045249	1 roll
	24 inches (610 mm) × 40 feet (12.2 m)	S045250	1 roll
	36 inches (914 mm) × 40 feet (12.2 m)*	S045251	1 roll
	44 inches (1118 mm) × 40 feet (12.2 m)*	S045252	1 roll

Paper Type	Size	Part number	Sheet count
Epson Exhibition Canvas Gloss	13 inches (330 mm) × 20 feet (6.1 m)	S045241	1 roll
	17 inches (432 mm) × 40 feet (12.2 m)	S045242	1 roll
	24 inches (610 mm) × 40 feet (12.2 m)	S045243	1 roll
	36 inches (914 mm) × 40 feet (12.2 m)*	S045244	1 roll
	44 inches (1118 mm) × 40 feet (12.2 m)*	S045245	1 roll
Epson Exhibition Fiber Paper	17 inches (432 mm) × 50 feet (15.2 m)	S045188	1 roll
	24 inches (610 mm) × 50 feet (15.3 m)	S045189	1 roll
	44 inches (1118 mm) × 50 feet (15.3 m)*	S045190	1 roll
Epson Premium Glossy Photo Paper (250)	16 inches (406 mm) × 100 feet (30.5 m)	S041742	1 roll
	24 inches (610 mm) × 100 feet (30.5 m)	S041638	1 roll
	36 inches (914 mm) × 100 feet (30.5 m)*	S041639	1 roll
	44 inches (1118 mm) × 100 feet (30.5 m)*	S041640	1 roll
Epson Premium Semigloss Photo Paper (170)	24 inches (610 mm) × 100 feet (30.5 m)	S041393	1 roll
	36 inches (914 mm) × 100 feet (30.5 m)*	S041394	1 roll
	44 inches (1118 mm) × 100 feet (30.5 m)*	S041395	1 roll

Paper Type	Size	Part number	Sheet count
Epson Premium Semimatte Photo Paper (250)	16 inches (406 mm) × 100 feet (30.5 m)	S042149	1 roll
	24 inches (610 mm) × 100 feet (30.5 m)	S042150	1 roll
	36 inches (914 mm) × 100 feet (30.5 m)*	S042151	1 roll
	44 inches (1118 mm) × 100 feet (30.5 m)*	S042152	1 roll
Epson Premium Glossy Photo Paper (170)	16.5 inches (419 mm) × 100 feet (30.5 m)	S042076	1 roll
	24 inches (610 mm) × 100 feet (30.5 m)	S041390	1 roll
	36 inches (914 mm) × 100 feet (30.5 m)*	S041391	1 roll
	44 inches (1118 mm) × 100 feet (30.5 m)*	S041392	1 roll
Epson Enhanced Matte Paper	16 inches (406 mm) × 100 feet (30.5 m)	S041725	1 roll
	24 inches (610 mm) × 100 feet (30.5 m)	S041595	1 roll
	36 inches (914 mm) × 100 feet (30.5 m)*	S041596	1 roll
	44 inches (1118 mm) × 100 feet (30.5 m)*	S041597	1 roll

Paper Type	Size	Part number	Sheet count
Epson Singleweight Matte Paper	17 inches (432 mm) × 132 feet (40.2 m)	S041746	1 roll
	24 inches (610 mm) × 132 feet (40.2 m)	S041853	1 roll
	36 inches (914 mm) × 132 feet (40.2 m)*	S041854	1 roll
	44 inches (1118 mm) × 132 feet (40.2 m)	S041855	1 roll
Epson Doubleweight Matte Paper	24 inches (610 mm) × 82 feet (25 m)	S041385	1 roll
	36 inches (914 mm) × 82 feet (25 m)*	S041386	1 roll
	44 inches (1118 mm) × 82 feet (25 m)*	S041387	1 roll
Epson Legacy Platine	17 inches (432 mm) × 50 feet (15.2 m)	S450076	1 roll
	24 inches (610 mm) × 50 feet (15.3 m)	S450077	1 roll
	44 inches (1118 mm) × 50 feet (15.3 m)*	S450078	1 roll
	Letter (8.5 × 11 inches [216 × 279 mm])	S450079	25
	13 × 19 inches (330 × 483 mm)	S450080	25
	17 × 22 inches (432 × 559 mm)	S450081	25

Paper Type	Size	Part number	Sheet count
Epson Legacy Fibre	17 inches (432 mm) × 50 feet (15.2 m)	S450082	1 roll
	24 inches (610 mm) × 50 feet (15.3 m)	S450083	1 roll
	44 inches (1118 mm) × 50 feet (15.3 m)*	S450084	1 roll
	Letter (8.5 × 11 inches [216 × 279 mm])	S450085	25
	13 × 19 inches (330 × 483 mm)	S450086	25
	17 × 22 inches (432 × 559 mm)	S450087	25
Epson Legacy Etching	17 inches (432 mm) × 50 feet (15.2 m)	S450088	1 roll
	24 inches (610 mm) × 50 feet (15.3 m)	S450089	1 roll
	44 inches (1118 mm) × 50 feet (15.3 m)*	S450090	1 roll
	Letter (8.5 × 11 inches [216 × 279 mm])	S450091	25
	13 × 19 inches (330 × 483 mm)	S450092	25
	17 × 22 inches (432 × 559 mm)	S450093	25
Epson Legacy Baryta	17 inches (432 mm) × 50 feet (15.2 m)	S450094	1 roll
	24 inches (610 mm) × 50 feet (15.3 m)	S450095	1 roll
	44 inches (1118 mm) × 50 feet (15.3 m)*	S450096	1 roll
	Letter (8.5 × 11 inches [216 × 279 mm])	S450097	25
	13 × 19 inches (330 × 483 mm)	S450098	25
	17 × 22 inches (432 × 559 mm)	S450099	25

Paper Type	Size	Part number	Sheet count
Epson Legacy Textured	17 inches (432 mm) × 50 feet (15.2 m)	S450311	1 roll
	24 inches (610 mm) × 50 feet (15.3 m)	S450312	1 roll
	44 inches (1118 mm) × 50 feet (15.3 m)*	S450313	1 roll
	Letter (8.5 × 11 inches [216 × 279 mm])	S450308	25
	13 × 19 inches (330 × 483 mm)	S450309	25
	17 × 22 inches (432 × 559 mm)	S450310	25

* SureColor P9500 Series only

Parent topic: [Media Handling](#)

Borderless Paper Type Compatibility

You can print borderless photos on compatible paper types in compatible paper widths:

Examples of Borderless Paper Types

- Epson Singleweight Matte Paper
- Epson Doubleweight Matte Paper
- Epson Premium Glossy Photo Paper (250)
- Epson Premium Semigloss Photo Paper (170)
- Epson Premium Glossy Photo Paper (170)
- Epson Premium Semimatte Photo Paper (250)
- Epson Premium Luster Photo Paper (260)

Borderless Paper Widths

- 10 inches (254 mm)
- 11.8 inches (300 mm)
- 13 inches (330 mm)

- 16 inches (406 mm)
 - 17 inches (432 mm)
 - 20.3 inches (515 mm)
 - 23 inches (594 mm)
 - 24 inches (610 mm)
 - 33 inches (841 mm)*
 - 36 inches (914 mm)*
 - 44 inches (1118 mm) *
- * SureColor P9500 Series only

Parent topic: [Media Handling](#)

Printing from a Computer

Note: If you have an Internet connection, it is a good idea to check for updates to your product software on Epson's support website. If you see a Software Update screen, select **Enable automatic checking** and click **OK**. The update scans your system to see if you have the latest product software. Follow the on-screen instructions.

[Printing with Windows](#)

[Printing on a Mac](#)

Printing with Windows

You can print with your product using any Windows application, as described in these sections.

Note: If you are using your Epson product with the Windows 10 S operating system, you cannot use the software described in this section. You also cannot download and install any Epson product software from the Epson website for use with Windows 10 S; you must obtain software only from the Windows Store.

[Selecting Basic Print Settings - Windows](#)

[Selecting Print Layout Options - Windows](#)

[Selecting Additional Settings - Windows](#)

[Saving, Sharing, and Customizing the Printer Settings](#)

[Printing Your Document or Photo - Windows](#)

[Selecting Default Print Settings - Windows](#)

[Changing the Language of the Printer Software Screens](#)

[Changing Automatic Update Options](#)

Parent topic: [Printing from a Computer](#)

Selecting Basic Print Settings - Windows

Select the basic settings for the photo or document you want to print.

1. Open a photo or document for printing.

2. Select the print command in your application.

Note: You may need to select a print icon on your screen, the **Print** option in the File menu, or another command. See your application's help utility for details.

3. If necessary, select your product name as the printer you want to use.

Note: You may also need to select **Preferences**, **Properties**, **Print Settings**, or **Printer Properties** to view your print settings.

You see the Main tab of your printer settings window:



4. Select the **Media Type** setting that matches the paper you loaded.

Note: You can click **Custom Settings** to select a custom paper configuration.

5. If you are using non-Epson paper or media and you need to fine-tune its performance, select the **Media Type** setting that is closest to the paper you loaded, click the **Paper Config** button, and adjust the **Color Density** option as necessary.
6. Select a **Color** option:
 - To print a color document or photo, select the **Color** setting.
 - To print text and graphics in black or shades of gray, select the **Advanced B&W Photo** or **Black** setting.

Note: The **Black** setting is available only when plain paper is selected as the **Media Type**.

7. For the **Print Quality** setting, select **Quality**, **High Quality**, or **Max Quality** (available with certain media types only), or select **Quality Options** and choose the quality option that matches the print quality you want to use.
8. Select **Black Enhance Overcoat** to print with darker tones of black.

Note: The **Black Enhance Overcoat** setting may not be available depending on the selected paper type.

9. Select the desired color management option as the **Mode** setting.
10. Select the **Source** setting that matches the paper feeding method you are using.
11. Select the size of the paper you loaded as the **Size** setting.

Note: You can also select the **User-Defined** setting to create a custom paper size.

12. If you are printing on roll paper, click the **Roll Paper Option** button and adjust the settings as necessary.
13. When Auto Cut is enabled, select the **Save Roll Paper** checkbox to have the printer cut the roll paper at the end of the image as it is positioned on the page.
14. If you want to print a photo without borders, select **Borderless**.

Note: You must select a compatible borderless paper type and size to print without borders. Check the borderless paper compatibility list for details.

15. To see a preview of how your document or photo will print, select **Print Preview**. (The preview appears after you click **Print** but before printing starts.)
16. To layout multiple print jobs for printing all at once, select **Layout Manager**.

[Paper Configuration Options - Windows](#)
[Advanced B&W Photo Options - Windows](#)
[Print Quality Options - Windows](#)
[Color Management Options - Windows](#)
[Advanced Color Controls - Windows](#)
[Paper Source Options - Windows](#)
[Roll Paper Options - Windows](#)
[Using Layout Manager - Windows](#)

Parent topic: [Printing with Windows](#)

Related references

[Borderless Paper Type Compatibility](#)

Related tasks

[Printing Your Document or Photo - Windows](#)

Paper Configuration Options - Windows

Select any of the available Paper Configuration options to fine-tune the quality of your print.

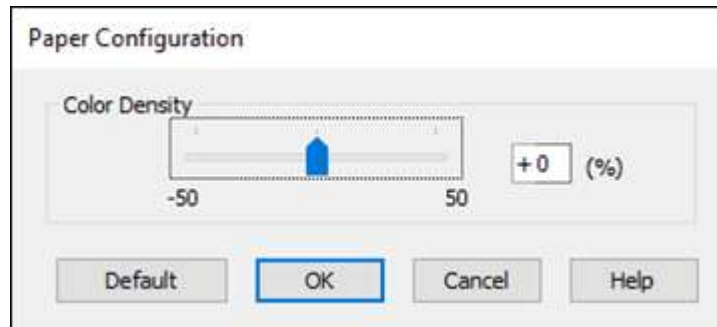

Color Density

Adjusts the ink saturation level.

Parent topic: [Selecting Basic Print Settings - Windows](#)

Advanced B&W Photo Options - Windows

If you select **Advanced B&W Photo** as the Color option, you can easily produce neutral and toned black-and-white prints. Whether your photo is color or grayscale, you can use this screening and color management technology to create stunning black-and-white prints. Click **Advanced** and select any of the available options. You can also use **Black Enhanced Overcoat** to print darker tones of black.

Color Toning

Adds tone (hue) to your black-and-white output. The default is **Neutral**, which provides a neutral tonal scale print. You can also choose other popular presets such as **Cool**, **Warm**, and **Sepia**. Note that the presets affect the target in the tone color circle.

Tone

Changes the entire tonal scale of your black-and-white output. While **Darker** is the default setting, you may see better results if you choose **Dark**. The tone color circle adjusts the hue of your black-and-white print. Click on any portion of the color wheel or enter corresponding values to customize the tone (hue) to add to your print. The closer you select to the edge of the wheel, the more color you add.

Brightness

Adjusts the overall lightness and darkness of your image.

Contrast

Adjusts the difference between the light and dark areas of your image.

Shadow Tonality

Controls tonality only in the shadow areas of your image.

Highlight Tonality

Controls tonality only in the highlight areas of your image.

Max Optical Density

Adjusts the overall density or focus of the print. Create a soft focus print by lowering the density setting.

Highlight Point Shift

Helps reduce gloss differential on glossy media by adding density to the highlights of your image.

Parent topic: [Selecting Basic Print Settings - Windows](#)

Print Quality Options - Windows

You can use the Speed/Quality slider to set the desired quality level and select any of the available Print Quality options to fine-tune the quality of your print. Some settings may be unavailable, depending on the paper type and border setting you have chosen.

High Speed

Speeds up printing but may reduce print quality.

Edge Smoothing

Smooths jagged edges in low-resolution images such as screen captures or images from the Web.

Finest Detail

Sharpens edges on vector-based data including text, graphics, and line art. (This setting does not affect photographs.)

Note: Enabling **Finest Detail** may decrease the print speed.

Black Enhance Overcoat

Prints darker tones of black by overcoating the black ink with gray.

Note: Printing with **Black Enhance Overcoat** increases the edge margins. Select **Quality Options > Minimize Top Margin** to reduce the size of the margins. This may lower print quality and may cause paper that curls easily to rub against the print head.

Paper Edge Quality

Prevents images on the edge of the paper from appearing faint or scuffed but may increase the margins.

Note: Selecting **Paper Edge Quality** will decrease the print speed.

Parent topic: [Selecting Basic Print Settings - Windows](#)

Color Management Options - Windows

You can adjust the **Mode** setting to fine-tune the colors in your printout or turn off color management in your printer software.

EPSON Standard (sRGB)

Increases the contrast in images.

Note: This is the standard mode for most photos and documents when not using an ICC profile.

Adobe RGB

Matches image colors to the Adobe RGB color standard. Use this setting if your source file was captured in Adobe RGB.

ICM

Automatically adjusts colors based on the printer's ICC profile and the selected **Media Type** setting, using the Image Color Matching system. Click the **Advanced** button to choose the input profile and other settings.

Note: In most cases, you get better results by applying color management in your application, rather than in the printer driver.

Off (No Color Adjustment)

Turns off color management in your printer software so you can manage color using only your application software.

Note: An ICC profile is required if color management is turned off.

Parent topic: [Selecting Basic Print Settings - Windows](#)

Advanced Color Controls - Windows

If you selected **Custom** as the **Mode** setting and **Color Controls** from the dropdown menu, you can click the **Advanced** button to select detailed settings.

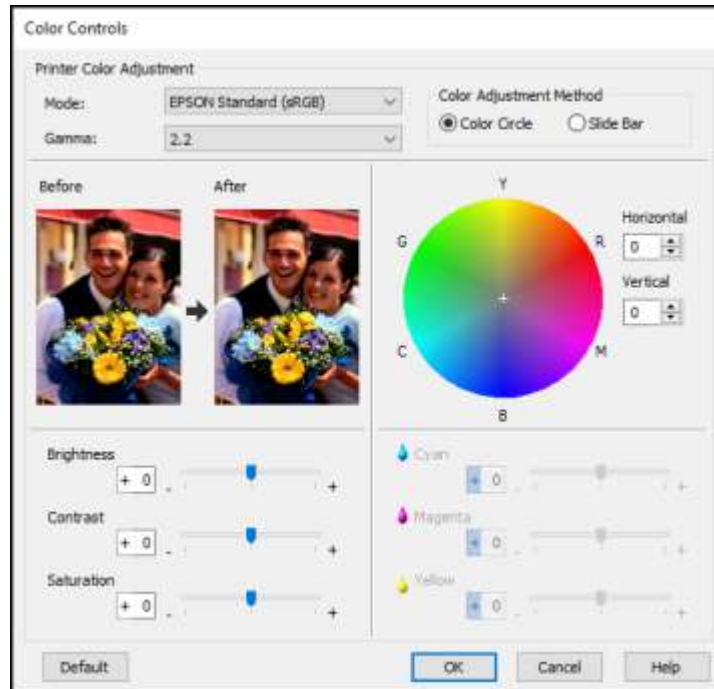

The Color Controls screen lets you specify values for adjusting brightness, contrast, saturation, and individual Cyan, Magenta, and Yellow color tones. You can choose from two Printer Color Adjustment modes and two Gamma settings, and use either a color circle or slide bar to adjust color.

Parent topic: [Selecting Basic Print Settings - Windows](#)

Paper Source Options - Windows

You can select any of the available options in the paper Source menu to print on the paper loaded in that source.

Roll Paper

Selects roll paper loaded in the roll paper holder.

Roll Paper (Banner)

Selects roll paper loaded in the roll paper holder for a series of continuous images without any margin space between them.

Sheet

Selects sheets of paper loaded in the sheet feeder.

Poster Board

Selects poster board or other thick media loaded in the cut sheet feed slot.

Parent topic: [Selecting Basic Print Settings - Windows](#)

Roll Paper Options - Windows

Select any of the available roll paper options.

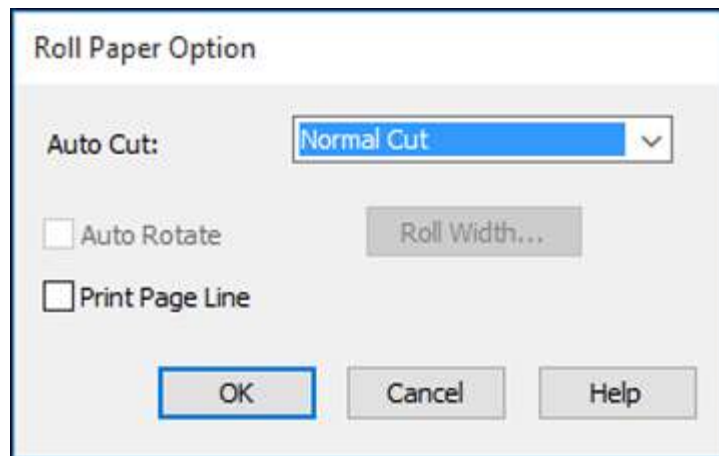

Note: Some settings may not be available, depending on the Roll Paper Option you selected for your paper size.

Auto Cut options:

- **Off:** Select this option to cut your prints manually.
- **Normal Cut:** Creates a margin at the top and bottom of your image. These margins vary by media type and may be changed from their defaults using custom media settings.

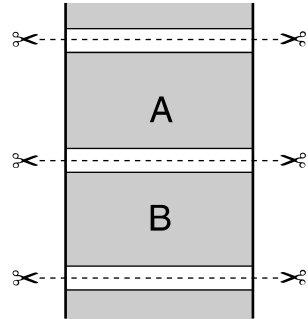

- **Single Cut:** Prints images within the same print job end-to-end with no gap between them. Borderless images may overlap slightly.

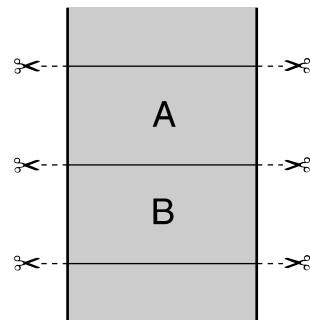

- **Double Cut:** Increases the space between each image and trims each print individually, providing the cleanest edge with no image overlap for borderless printing.

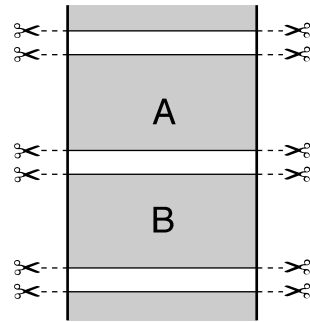

Auto Rotate

Automatically positions the image or file to fit the roll paper. When Auto Rotate is selected, select the width of the paper as the **Roll Width** setting.

Print Page Line

Prints lines between pages as a guide for manual cutting.

Parent topic: [Selecting Basic Print Settings - Windows](#)

Using Layout Manager - Windows

Layout Manager lets you create a poster or display by dragging multiple pieces of print data created in different applications onto one sheet of paper for printing.

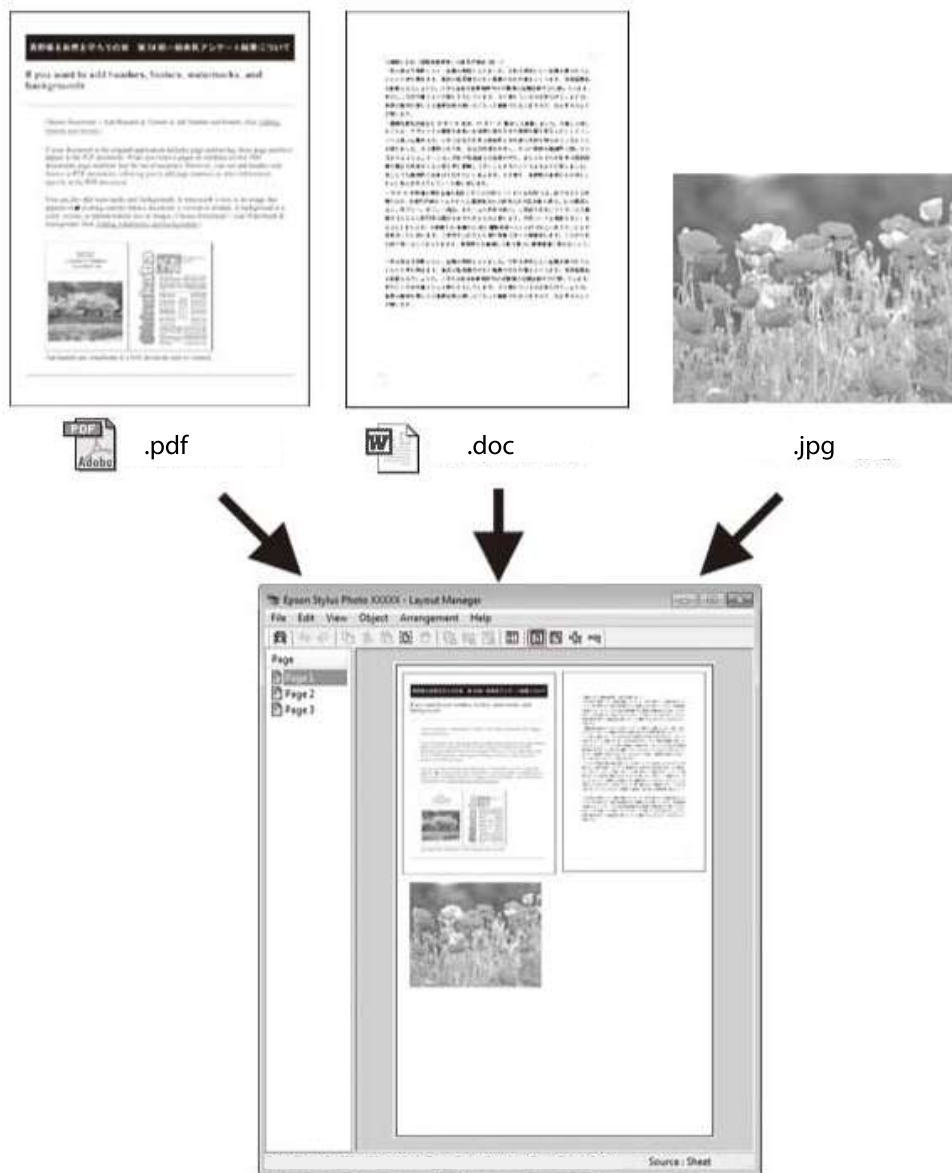

You can also place the same print data multiple times as shown here.



You can place print data in different sizes and orientations to maximize media usage, as shown here.

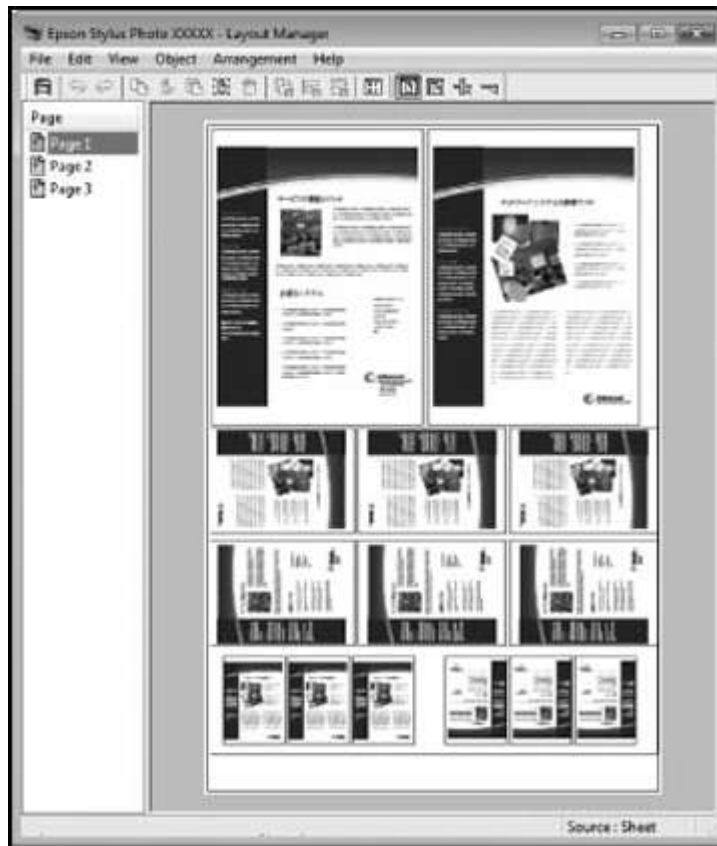

You can place print data on roll paper as shown here.

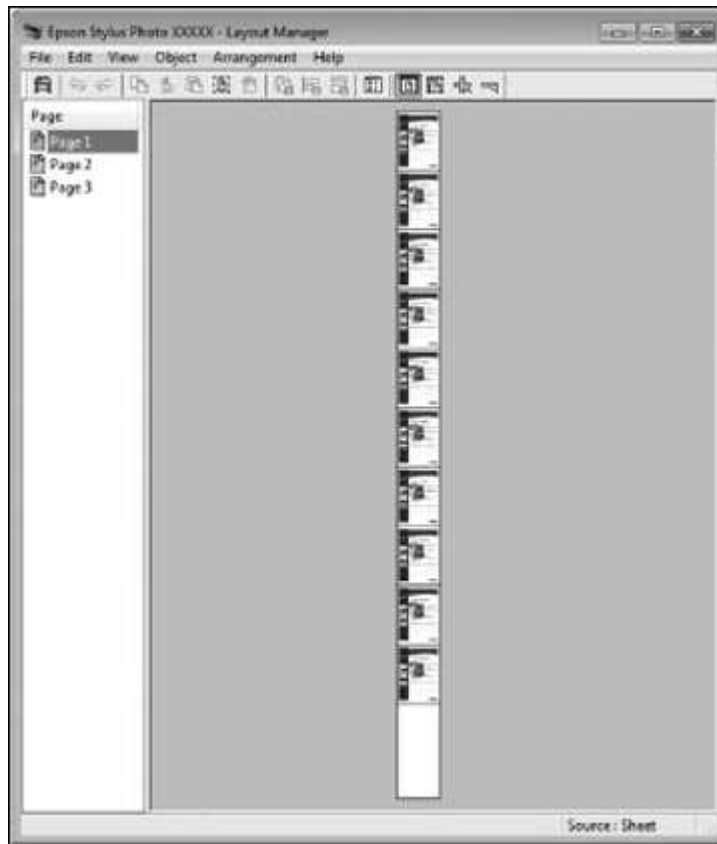

1. Open the file you want to print in your application.
2. Select the print command in your application.

3. Select **Layout Manager** on the Main tab and choose an option for the **Size** setting that matches the size of the document in your application.



Note: You select the size of the paper you are printing on in a later step.

4. Click **OK** and then click **Print**, if necessary.
The Layout Manager screen opens and displays one page in the layout.
5. Leave the Layout Manager screen open and repeat steps 1 to 4 to arrange additional print data. The pages are added to the Layout Manager screen.
6. Do the following to arrange objects on the Layout Manager screen:
 - Drag pages to move and resize them.
 - Use the tool buttons and the Object menu to align and rotate pages.

- Resize and replace whole pages in the Preference or Arrangement Settings screens.

Note: See the Layout Manager screen help for details.

7. Click **File > Properties**, then select your print settings, including the size of the paper you are printing on, on the Main tab.
8. Click the **File** menu on the Layout Manager screen and click **Print**.

Note: To save the current job to a file, click the **File** menu on the Layout Manager screen, save the file, and close the Layout Manager screen. To open the saved file later for editing or reprinting, right-click the printer icon in the Windows taskbar, click **Layout Manager**, and open the file.

Parent topic: [Selecting Basic Print Settings - Windows](#)

Selecting Print Layout Options - Windows

You can select a variety of sizing and layout options for your document or photo on the Page Layout tab.

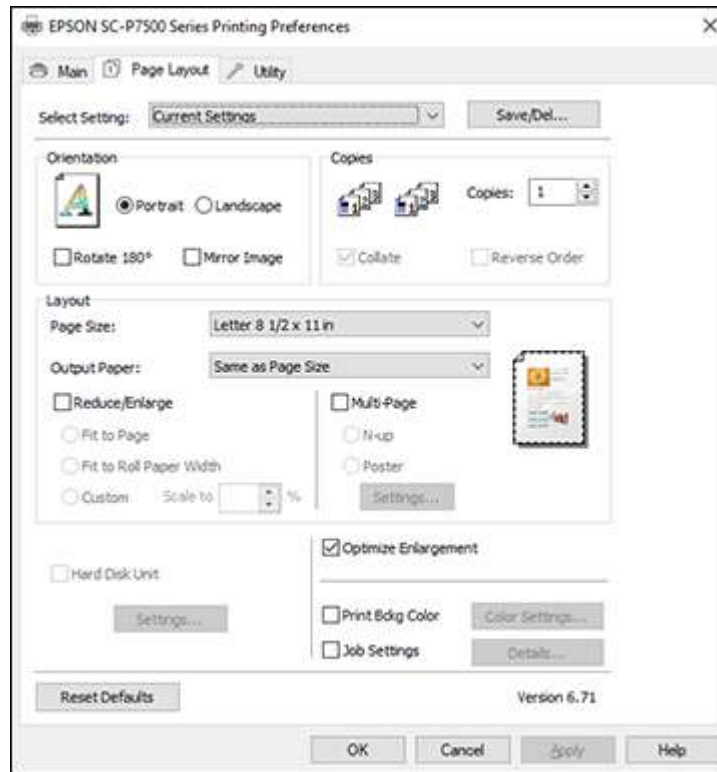

- To change the orientation of your printed document or photo, select the **Portrait** or **Landscape** checkbox.
- To rotate or flip the printed image, select the **Rotate 180°** or **Mirror Image** checkbox.
- To select multiple copies and their print order, select the **Copies**, **Collate**, and **Reverse Order** options.
- To change the size of your printed document or photo, select the **Reduce/Enlarge** checkbox and select sizing options.
- To print multiple pages on one sheet of paper, or print one image on multiple sheets of paper, select the **Multi-Page** checkbox and select the options you want.

- To manage print jobs with the optional internal print server (if applicable), select the **Hard Disk Unit** checkbox and select the options you want.
- To enlarge your image beyond the limits of your application program, select the **Optimize Enlargement** checkbox.

Note: The driver can increase the image size up to 650% and decrease the output resolution to stay within the pixel limitations. Depending on the resolution of the original image and the print size, you may see reduced print quality.

- To print a color background on the page, select the **Print Bckg Color** checkbox and click **Color Settings** to select the color you want to use.
- To print the time, date, and other information about your print job at the top or bottom of the page, select the **Job Settings** checkbox and click **Details** to select the settings you want to use.

[Reduce/Enlarge Options - Windows](#)

[Multi-Page Printing Options - Windows](#)

Parent topic: [Printing with Windows](#)

Reduce/Enlarge Options - Windows

You can select any of the Reduce/Enlarge options to size your printed image.

Fit to Page

Sizes your printed image to fit on the paper you loaded and selected as the Output Paper setting.

Fit to Roll Paper Width

Sizes your printed image to fit the width of the roll paper you loaded.

Custom

Sizes your printed image by the percentage you select as the **Scale to** setting.

Parent topic: [Selecting Print Layout Options - Windows](#)

Multi-Page Printing Options - Windows

You can select these Multi-Page options to set up your multi-page print job.

N-up

Prints 2 (**2-up**) or 4 (**4-up**) pages on one sheet of paper.



Poster

Prints one image on multiple sheets of paper to create a large poster with or without borders. Click the **Settings** button to select the layout and guideline options.

Parent topic: [Selecting Print Layout Options - Windows](#)

Selecting Additional Settings - Windows

You can run maintenance utilities and select additional settings that apply to all the print jobs you send to your product.

1. Access the Windows Desktop and right-click the  icon for your product in the right side of the Windows taskbar, or click the up arrow and right-click .
2. Select **Printer Settings**.
3. Click the **Utility** tab.

You see a window like this:

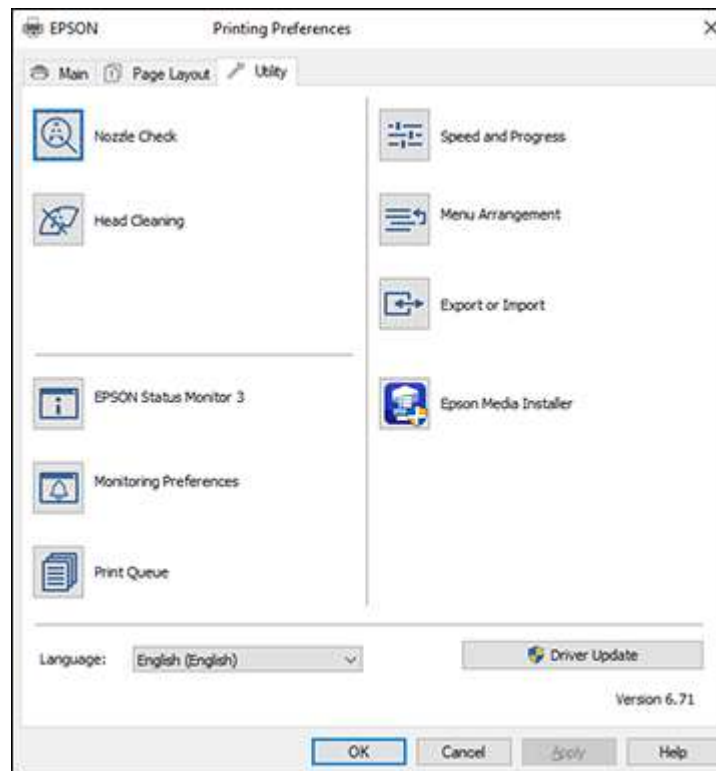

4. Select any of the following options, as necessary:
 - **Nozzle Check** to print a nozzle check pattern to check whether the print head nozzles are clogged.
 - **Head Cleaning** to clean the print head if you notice banding or gaps in your printouts.
 - **Epson Status Monitor 3** to check the printer's status.
 - **Monitoring Preferences** to select the error notifications displayed on the Epson Status Monitor 3 screen, or add a shortcut to the utility in the Windows taskbar.
 - **Print Queue** to display a list of all waiting print jobs, view information on the data waiting to be printed, and delete or reprint the jobs.
 - **Language** to select the language you want to use for the printer software screens.
 - **Speed and Progress** to select various printing options.
 - **Menu Arrangement** to arrange the **Setting**, **Media Type**, and **Paper Size** options by frequency of use.
 - **Export or Import** to save the print settings to a file or import them from a file. This is useful when you want to select the same print settings on multiple computers.
 - **Epson Media Installer** to create and manage custom paper configurations.
5. Click **OK** to close the printer software window.

Parent topic: [Printing with Windows](#)

Related concepts

[Print Head Nozzle Check](#)

[Print Head Cleaning](#)

Related tasks

[Creating Custom Paper Settings Using Epson Media Installer](#)

[Downloading Epson Media Settings](#)

[Checking Print Status - Windows](#)

[Checking Print Status - Mac](#)

Saving, Sharing, and Customizing the Printer Settings

You can save groups of print settings or media settings so you can reuse them for future print jobs. You can export these settings as a file so you can share them with other users. You can also edit the settings displayed in the printer software screens.

[Saving and Sharing Print Settings - Windows](#)

Saving and Sharing Media Settings - Windows

Editing Print Setting Displays - Windows

Parent topic: [Printing with Windows](#)

Saving and Sharing Print Settings - Windows

You can save your print settings so you can use them for future print jobs.

1. Select the print settings you want to save.
2. Click **Save/Del** at the top of the Main or Page Layout tab in your printer software.

You see a window like this:

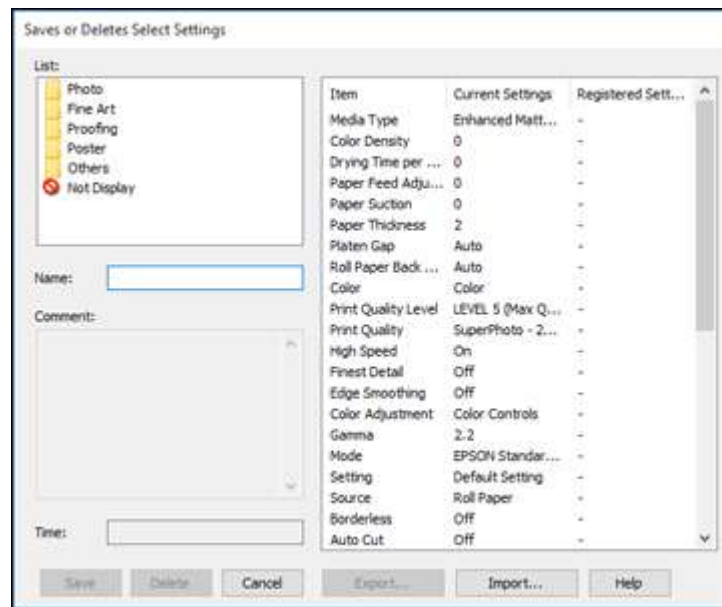

3. Verify that your settings are correct, enter a name for the group of settings in the **Name** field, and click **Save**.

Note: If you need to delete a group of settings you have created, select the name of the group of settings from the list and click **Delete**.

4. Do the following as necessary:
 - Select the name of the group of settings from the Select Setting list and use them to print.
 - To export the settings, click **Save/Del**, select the name of the group of settings, click **Export**, select a location, and enter a file name.
 - To import a group of settings, click **Save/Del**, click **Import**, select the file you want to use, and click **Open**. Then use the settings to print.

Parent topic: [Saving, Sharing, and Customizing the Printer Settings](#)

Saving and Sharing Media Settings - Windows

You can save and share settings you have selected for a particular media type so you can use them for future print jobs.

1. Select the Media Settings you want to save on the Main tab, as necessary.
2. Click **Custom Settings**.

You see a window like this:

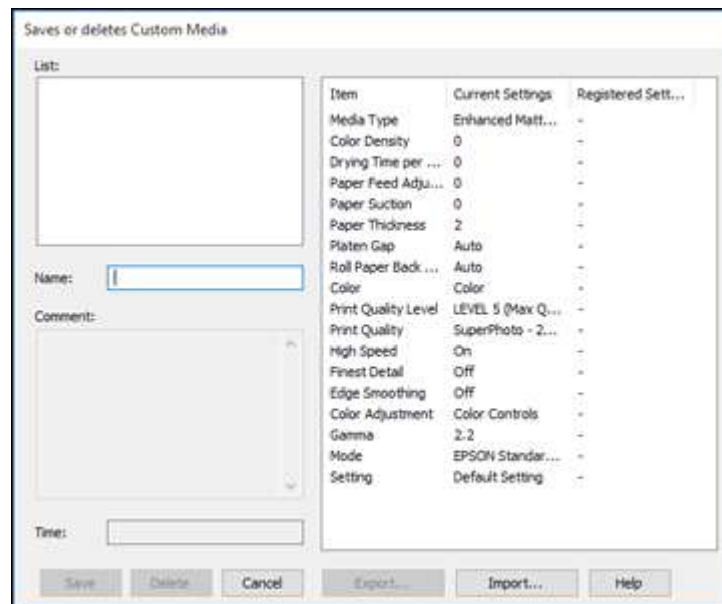

3. Verify that your settings are correct, enter a name for the media settings in the **Name** field, and click **Save**.

Note: If you need to delete a group of settings you have created, select the name of the settings from the list and click **Delete**.

4. Do the following as necessary:
 - Select the name of a media setting as the **Media Type** setting and use it to print.
 - To export the settings, click **Custom Settings**, select the name of the media settings, click **Export**, select a location, and enter a file name.
 - To import settings, click **Custom Settings**, select the name of the media settings, click **Import**, select the file you want to use, and click **Open**. Then use these settings to print.

Parent topic: [Saving, Sharing, and Customizing the Printer Settings](#)

Editing Print Setting Displays - Windows

You can arrange the displayed print settings so you can easily select the settings you use most often.

1. Click the **Utility** tab in the printer software.
2. Select **Menu Arrangement**.

You see this window:

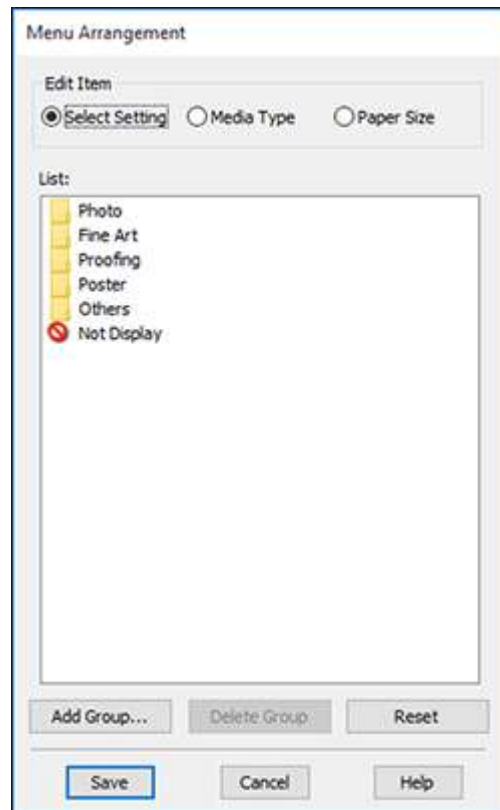

3. Select the item you want to edit.
4. Order or group items in the **List** box as follows:
 - To move and reorder items, drag and drop them in the list.
 - To add a new group (folder), click **Add Group**.
 - To delete a group (folder), select the group and click **Delete Group**.
 - To hide a group, drag and drop it to **Not Display**.

Note: If you delete a group, the group folder is deleted but the items within the folder remain.

5. Click **Save**.

Parent topic: [Saving, Sharing, and Customizing the Printer Settings](#)

Printing Your Document or Photo - Windows

Once you have selected your print settings, you are ready to save your settings and print.

1. Click **OK** to save your settings.

You see your application's Print window, such as this one:

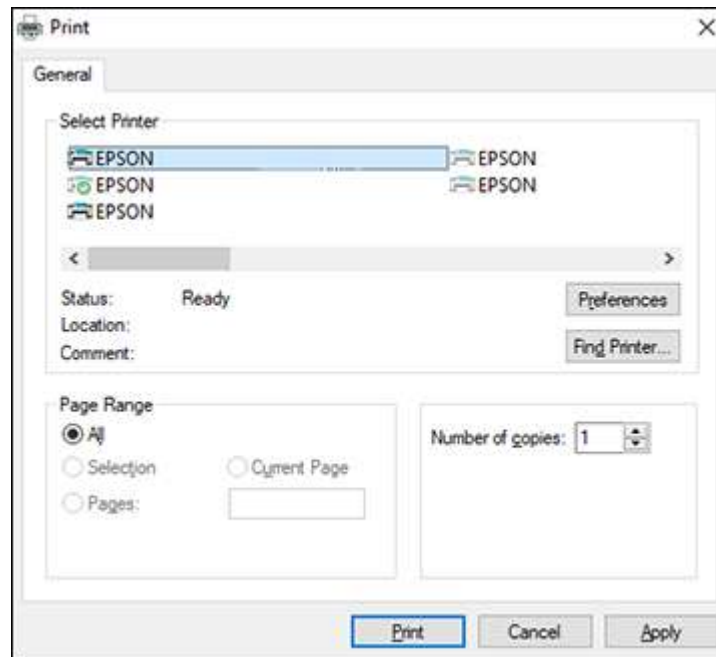

2. Click **OK** or **Print** to start printing.

[Checking Print Status - Windows](#)

Parent topic: [Printing with Windows](#)

Checking Print Status - Windows

During printing, you see this window showing the progress of your print job. It allows you to control printing and check ink cartridge status.





- To cancel printing, click **Cancel**.
- To see print jobs waiting to print, click **Print Queue**.

Parent topic: [Printing Your Document or Photo - Windows](#)

Selecting Default Print Settings - Windows

When you change your print settings in a program, the changes apply only while you are printing in that program session. If you want to change the print settings you use in all your Windows programs, you can select new default print settings.

1. Access the Windows Desktop and right-click the  icon for your product in the right side of the Windows taskbar, or click the up arrow and right-click .
2. Select **Printer Settings**.

You see the printer settings window:



3. Select the print settings you want to use as defaults in all your Windows programs.
4. Click **OK**.

These settings are now the defaults selected for printing. You can still change them as needed for printing in any program session.



Parent topic: [Printing with Windows](#)

Related tasks

[Selecting Basic Print Settings - Windows](#)

Changing the Language of the Printer Software Screens

You can change the language used on the Windows printer software screens.

1. Access the Windows Desktop and right-click the  icon for your product in the right side of the Windows taskbar, or click the up arrow and right-click .
2. Select **Printer Settings**.
You see the printer settings window.
3. Click the **Utility** tab.
You see these options:

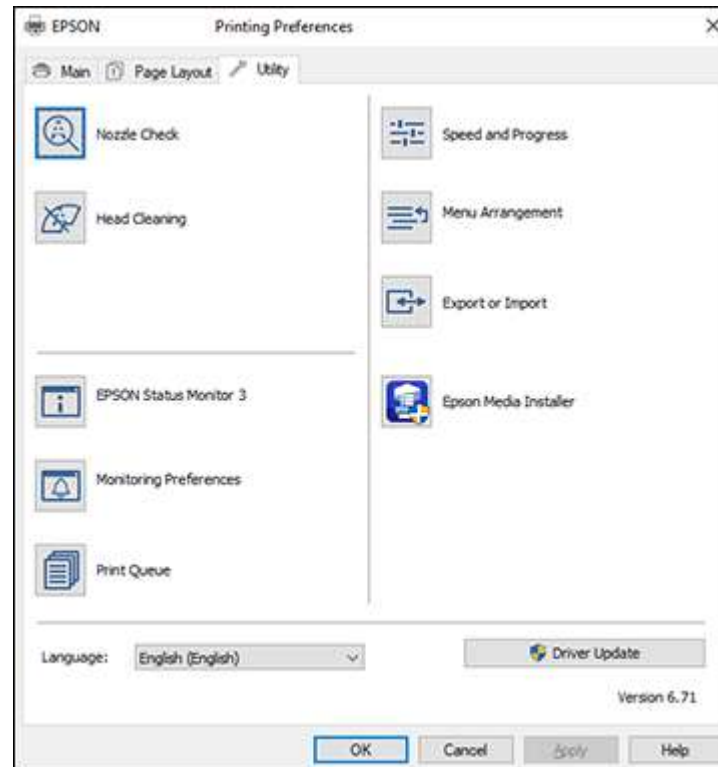



4. Select the language you want to use as the **Language** setting.
 5. Click **OK** to close the printer software window.
- The printer software screens appear in the language you selected the next time you access them.

Parent topic: [Printing with Windows](#)

Changing Automatic Update Options

Your printer software for Windows automatically checks for updates to the product software. You can change how often the software checks for updates or disable this feature.

1. Access the Windows Desktop and right-click the  icon for your product in the right side of the Windows taskbar, or click the up arrow and right-click .
2. Select **Software Update Settings**.

You see this window:

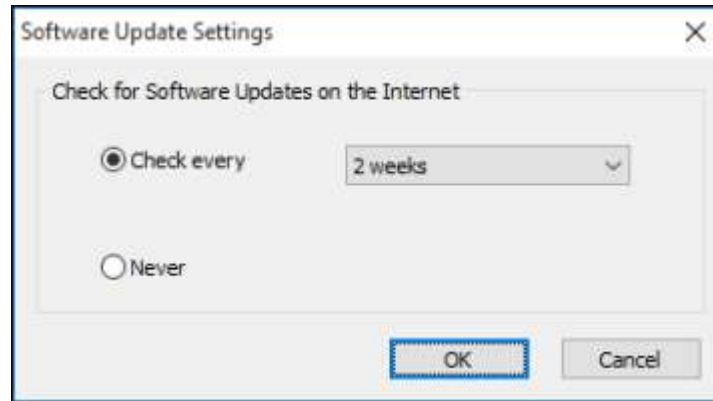

3. Do one of the following:
 - To change how often the software checks for updates, select a setting in the **Check every** menu.
 - To disable the automatic update feature, select the **Never** option.
4. Click **OK** to exit.

Note: If you choose to disable the automatic update feature, you can check for updates manually.

Parent topic: [Printing with Windows](#)

Printing on a Mac

You can print with your product using any Mac printing program, as described in these sections.

Note: If you have an Internet connection, it is a good idea to check for updates to your product software on Epson's support website.

[Selecting Basic Print Settings - Mac](#)

[Selecting Roll Paper Settings - Mac](#)

[Selecting Paper Configuration Settings - Mac](#)

[Selecting Print Layout Options - Mac](#)

[Managing Color - Mac](#)

[Sizing Printed Images - Mac](#)

[Selecting Printing Preferences - Mac](#)

[Printing Your Document or Photo - Mac](#)

Parent topic: [Printing from a Computer](#)

Selecting Basic Print Settings - Mac

Select the basic settings for the photo or document you want to print.

1. Open a photo or document for printing.
2. Select the print command in your application.

Note: You may need to select a print icon on your screen, the **Print** option in the File menu, or another command. See your application's help utility for details.

3. Select your product as the **Printer** setting.

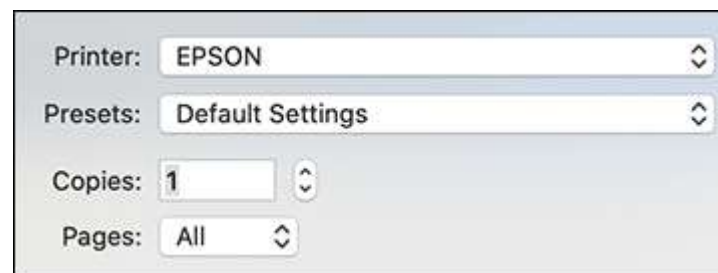

4. If necessary, click the arrow next to the Printer setting or the **Show Details** button to expand the print window.

You see the expanded printer settings window for your product:

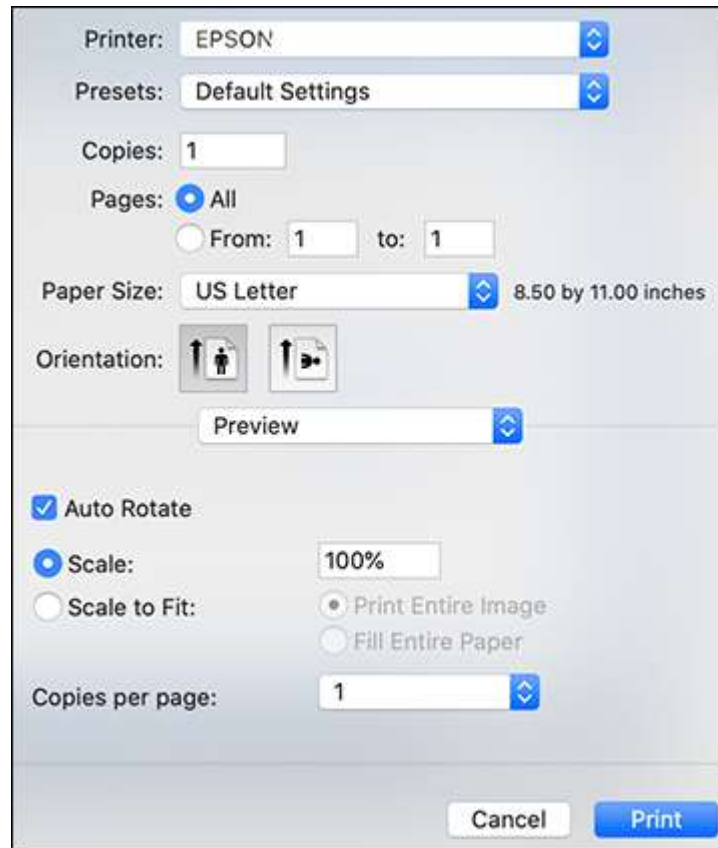

Note: The print window may look different, depending on the Mac OS version and the application you are using.

5. Select the **Copies** and **Pages** settings as necessary.

Note: If you do not see these settings in the print window, check for them in your application before printing. They may be accessible by selecting **Page Setup** from the File menu.

6. Select the size of the paper you loaded as the **Paper Size** setting.
 - To print a borderless photo, select a paper size with a **Borderless** option.
 - To print on roll paper, select a roll paper size or one with a **Borderless** option.

Note: For roll paper, make sure the maximum width of your photo is set to 24 or 44 inches to fit in the width of your roll paper (set the margins to 0 in your application software).

Note: You can reduce or enlarge the size of the printed image by selecting **Paper Handling** from the pop-up menu and selecting a scaling option.

7. Choose portrait or landscape as the **Orientation** setting.
8. Select any application-specific settings that appear on the screen, such as those shown in the image above for the Preview application.
9. Select **Printer Settings** from the pop-up menu.

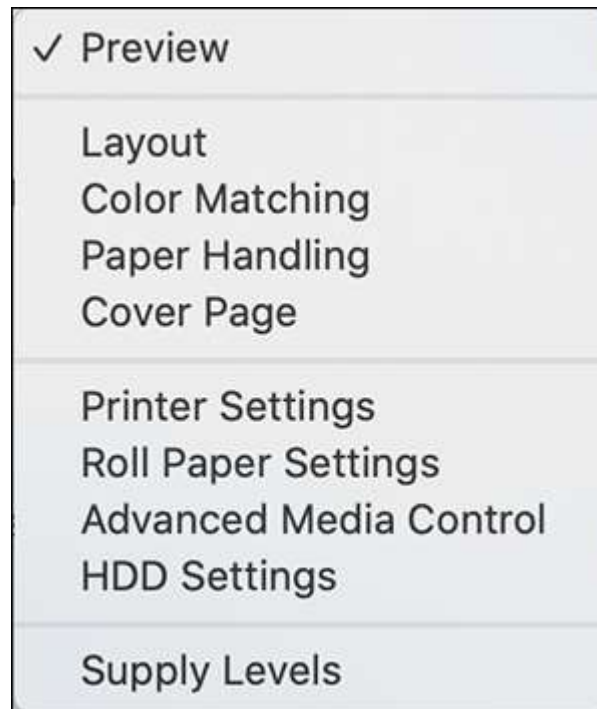

Note: In certain programs, you may need to select **Advanced** before you can select **Printer Settings**. For more information about printer settings, click the ? button.

You see these settings:

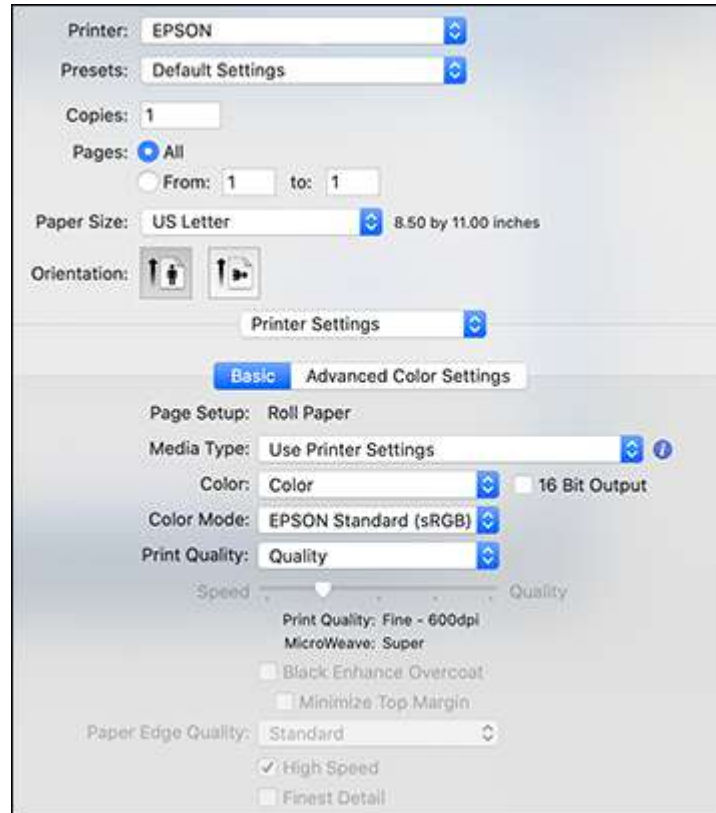

10. Select the type of paper you loaded as the **Media Type** setting.

Note: The setting may not exactly match the name of your paper. Check the media type settings list for details.

11. Select one of the following as the **Color** setting:

- Select **Color** for any type of photographic printing.

- Select **Advanced B&W Photo** to print black-and-white photos on certain types of photo paper. See the list of Advanced B&W Photo options for details. If your paper type does not support this option, print black-and-white photos using the **Color** setting.
 - Select **Black/Grayscale** when using plain paper.
12. Select one of the following as the **Color Mode** setting:
- **EPSON Standard (sRGB)**: Increases the contrast in images. Click the **Advanced Color Settings** tab to use advanced color controls.
 - **Adobe RGB**: Matches image colors to the Adobe RGB color standard. Use this setting if your source file was captured in Adobe RGB. Click the **Advanced Color Settings** tab to use advanced color controls.
 - **Off (No Color Adjustment)**: Turns off color management in your printer software so you can manage color using only your application software.

Note: If desired, you can instead use ColorSync to manage colors. In most cases, you get better results by applying color management in your application, rather than in the printer driver.

13. Select any of the available print options.

[Advanced Color Settings - Mac](#)

[Print Quality Settings - Mac](#)

[Print Options - Mac](#)

Parent topic: [Printing on a Mac](#)

Related tasks

[Selecting Roll Paper Settings - Mac](#)

Advanced Color Settings - Mac

When you click the **Advanced Color Settings** tab, you see one of the screens below depending on the **Color** setting you selected.

- **Color**

You can specify values for adjusting brightness, contrast, saturation, and individual Cyan, Magenta, and Yellow color tones.

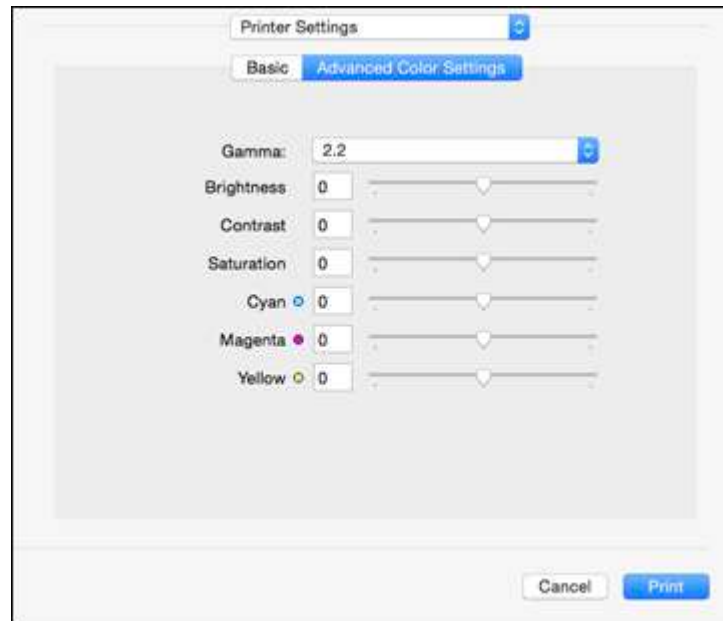

- **Advanced B&W Photo**

You can select any of the available options.

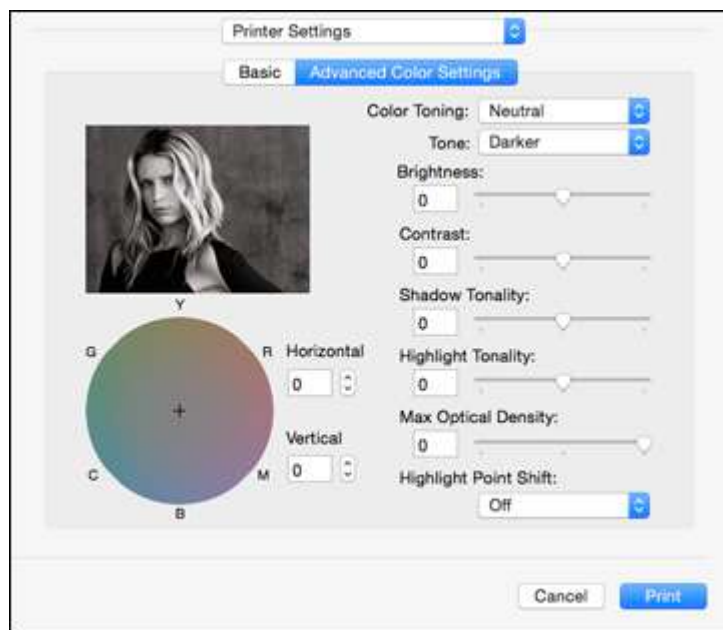

Color Toning

Adds tone (hue) to your black-and-white output. The default is **Neutral**, which provides a neutral tonal scale print. You can also choose other popular presets such as **Cool**, **Warm**, and **Sepia**. Note that the presets affect the target in the tone color circle.

Tone

Changes the entire tonal scale of your black-and-white output. While **Darker** is the default setting, you may see better results if you choose **Dark**. The tone color circle adjusts the hue of your black-and-white print. Click on any portion of the color wheel or enter corresponding values to customize the tone (hue) to add to your print. The closer you select to the edge of the wheel, the more color you add.

Brightness

Adjusts the overall lightness and darkness of your image.

Contrast

Adjusts the difference between the light and dark areas of the overall image.

Shadow Tonality

Controls tonality only in the shadow areas of your image.

Highlight Tonality

Controls tonality only in the highlight areas of your image.

Max Optical Density

Adjusts the overall density or focus of the print. Create a soft focus print by lowering the density setting.

Highlight Point Shift

Helps reduce gloss differential on glossy media by adding density to the highlights of your image.

Parent topic: [Selecting Basic Print Settings - Mac](#)

Print Quality Settings - Mac

You can select any of the **Print Quality** settings to fine-tune the quality of your print. Some settings may be unavailable, depending on the paper type and border setting you have chosen.

Quality

For photos and graphics with good quality and print speed.

High Quality

For photos and graphics with high print quality.

Max Quality

For the maximum print quality, but the slowest print speed.

Parent topic: [Selecting Basic Print Settings - Mac](#)

Print Options - Mac

You can select any of the print options to customize your print. Some options may be unavailable, depending on other settings you have chosen.

Black Enhance Overcoat

Prints darker tones of black by overcoating the black ink with gray.

Note: Printing with **Black Enhance Overcoat** increases the edge margins. Select **Quality Options > Minimize Top Margin** to reduce the size of the margins. This may lower print quality and may cause paper that curls easily to rub against the print head.

High Speed

Speeds up printing but may reduce print quality.

Finest Detail

Sharpens edges on vector-based data including text, graphics, and line art. (This setting does not affect photographs.)

Note: Enabling **Finest Detail** may decrease the print speed.

Parent topic: [Selecting Basic Print Settings - Mac](#)

Selecting Roll Paper Settings - Mac

To print on roll paper, you select the roll paper size and roll paper options from the Printer Settings menu.

1. Select **Manage Custom Sizes** as the **Paper Size** setting.
2. Click **+**, double-click **Untitled**, and enter a name for your roll paper size.
3. Enter the width of the roll paper image as the **Width** setting.

Note: Make sure your image fits within the width of your roll paper.

4. Enter the length of your roll paper image as the **Height** setting.

Note: Select your product from the Non-Printable Area menu to automatically select the largest paper size for your product.

5. Set the margin setting to **0**.
6. Click **OK**.
7. Select your new custom roll paper size as the **Paper Size** setting.
8. Select **Roll Paper Settings**.

You see this window:

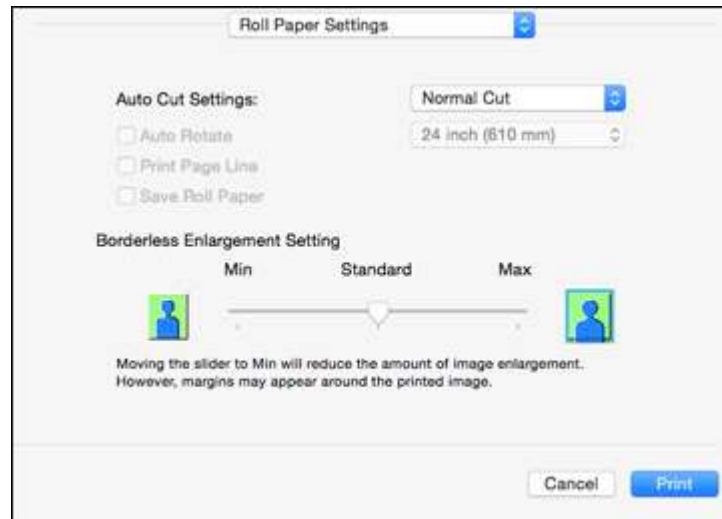

Note: Some settings may not be available, depending on the Roll Paper option you selected for your Paper Size.

9. Select one of the following **Auto Cut Settings**:
 - **Off:** Select this option to cut your prints manually.
 - **Normal Cut:** Creates a margin and the top and bottom of your image.

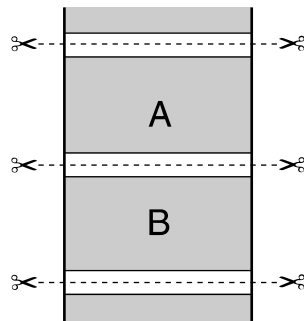

- **Single Cut:** Prints images end-to-end with no gap between them. Borderless images may overlap slightly.

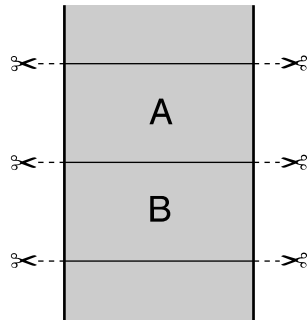

- **Double Cut:** Increases the space between each image and trims each print individually, providing the cleanest edge for borderless printing.

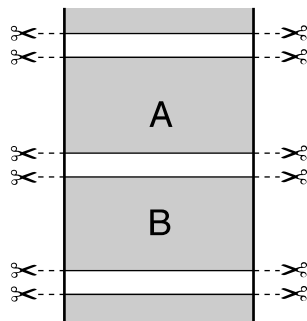

10. Select the following settings as necessary:

- Select the **Auto Rotate** checkbox and select the roll paper width to fit the images to the paper size.
- Select the **Print Page Line** checkbox to print trim lines around images when you select a banner paper size.
- Click **Save Roll Paper** to minimize the amount of blank paper wasted when you print on banner paper.
- Adjust the amount of image expansion when printing borderless images.

Note: This option is available only when you choose a Paper Size setting with a **Borderless** option.

11. Click **Print**.

Parent topic: [Printing on a Mac](#)

Related references

[Borderless Paper Type Compatibility](#)

Selecting Paper Configuration Settings - Mac

If you are using non-Epson media and need to fine-tune its print quality, select **Advanced Media Control** from the pop-up menu.

Note: Before adjusting the **Color Density** setting, select the Media Type setting that is closest to the paper you are using.



Parent topic: [Printing on a Mac](#)

Selecting Print Layout Options - Mac

You can select a variety of layout options by selecting **Layout** from the pop-up menu on the print window.

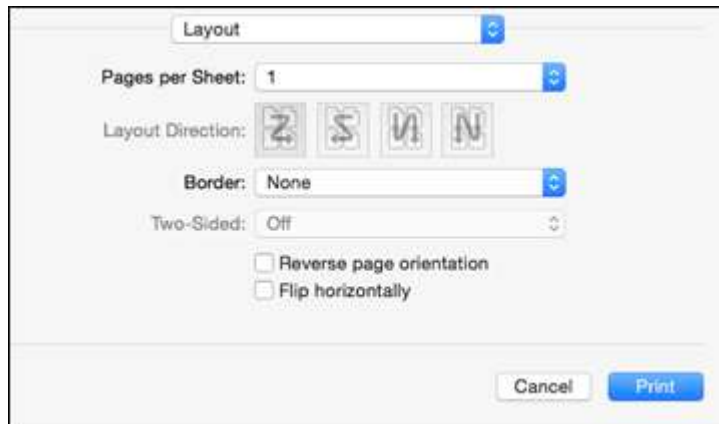

- To print multiple pages on one sheet of paper, select the number of pages in the **Pages per Sheet** pop-up menu. To arrange the print order of the pages, select a **Layout Direction** setting.
- To print borders around each page on the sheet, select a line setting from the **Border** pop-up menu.
- To invert or flip the printed image, select the **Reverse page orientation** or **Flip horizontally** settings.

Parent topic: [Printing on a Mac](#)

Managing Color - Mac

You can adjust the Color Matching settings to fine-tune the colors in your printout, or turn off color management in your printer software.

1. Select **Color Matching** from the pop-up menu in the print window.



2. Select one of the available options.

[Color Matching Options - Mac](#)

Parent topic: [Printing on a Mac](#)

Color Matching Options - Mac

You can select from these settings on the **Color Matching** menu.

ColorSync

Prints using standard color profiles for your product and paper to help match image colors.

EPSON Color Controls

Lets you manage color using controls in your printer software or turn off color management.

Parent topic: [Managing Color - Mac](#)

Sizing Printed Images - Mac

You can adjust the size of the image as you print it by selecting **Paper Handling** from the pop-up menu on the Print window.

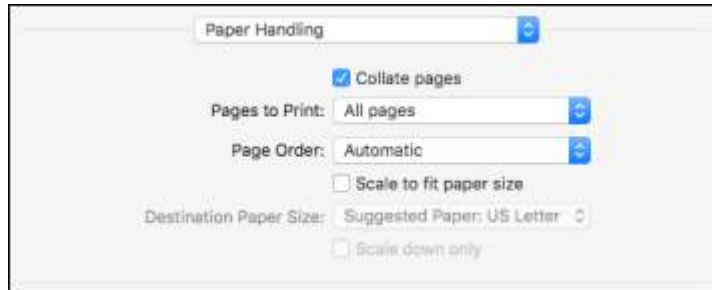

- To collate multiple copies into sets of documents, select the **Collate pages** checkbox.
- To print only selected pages in a multi-page document, select an option from the **Pages to Print** pop-up menu.
- To adjust the order in which pages are printed, select an option from the **Page Order** pop-up menu.
- To scale the image to fit on a specific paper size, select the **Scale to fit paper size** checkbox and select a paper size from the **Destination Paper Size** pop-up menu.
- To restrict scaling of the image to reduced sizing, select the **Scale down only** checkbox. (Deselect this checkbox when enlarging the image.)

Parent topic: [Printing on a Mac](#)

Selecting Printing Preferences - Mac

You can select printing preferences that apply to all the print jobs you send to your product.

1. In the Apple menu or the Dock, select **System Preferences**.
2. Select **Print & Fax**, **Print & Scan**, or **Printers & Scanners**, select your product, and select **Options & Supplies**.
3. Select **Options**.

You see a screen like this:

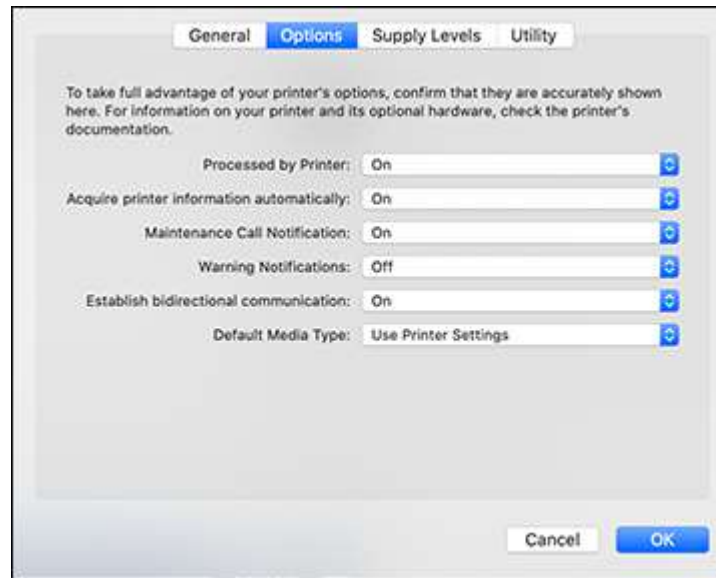

4. Select any of the available printing options.
5. Click **OK**.

[Printing Preferences - Mac](#)

Parent topic: [Printing on a Mac](#)

Printing Preferences - Mac

You can select from these settings on the **Options** tab.

Processed by printer

Lets the printer perform halftone processing.

Acquire printer information automatically

Ensures that the paper size and paper type settings are automatically updated if paper is loaded or changed after closing the print window.

Maintenance Call Notification

Alerts you if the maintenance tanks are nearing capacity or need to be replaced.

Warning Notifications

Lets you choose whether or not to receive warning notifications from the printer software for various operating conditions.

Establish bidirectional communication

Allows the product to communicate with the computer. Do not change the default setting unless you experience issues when using a shared printing pool.

Default media type

Select the Media Type that you want to use as the default in the printer driver.

Parent topic: [Selecting Printing Preferences - Mac](#)

Printing Your Document or Photo - Mac

Once you have selected your print settings, you are ready to print.

Click **Print** at the bottom of the print window.

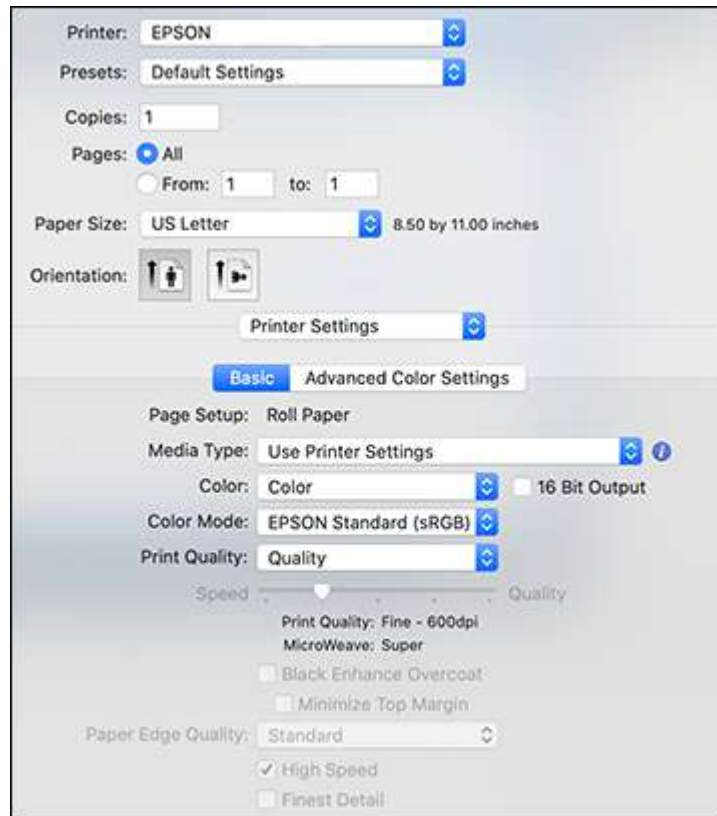

[Checking Print Status - Mac](#)

Parent topic: [Printing on a Mac](#)

Checking Print Status - Mac



During printing, you can view the progress of your print job, control printing, and check ink status.

1. Click the printer icon when it appears in the Dock.

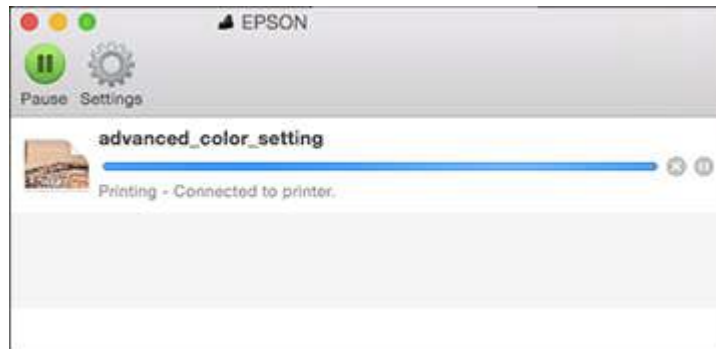
You see the print status window:



2. Select the following options as necessary for your Mac OS version:

- To cancel printing, click the print job and click  or **Delete**.
- To pause a print job, click the print job and click  or **Hold**. To resume a print job, click the paused print job and click  or **Resume**.
- To pause printing for all queued print jobs, click **Pause** or **Pause Printer**.
- To display other printer information, click **Settings** or **Supply Levels**.

Parent topic: [Printing Your Document or Photo - Mac](#)

Using the Control Panel Menus

Follow the instructions in these sections to access the printer menu system and select settings.

[Accessing the Printer's Menus](#)

[Paper Setting Menu](#)

[Basic Settings Menu](#)

[Printer Settings Menu](#)

[Network Settings Menu](#)

[System Administration Menu](#)

[Maintenance Menu](#)

[Status Menu](#)

Accessing the Printer's Menus

You can use the printer menus to adjust the settings that control how your printer works.

1. Press the  home button, if necessary.
2. Select **Menu**.

You see this screen:

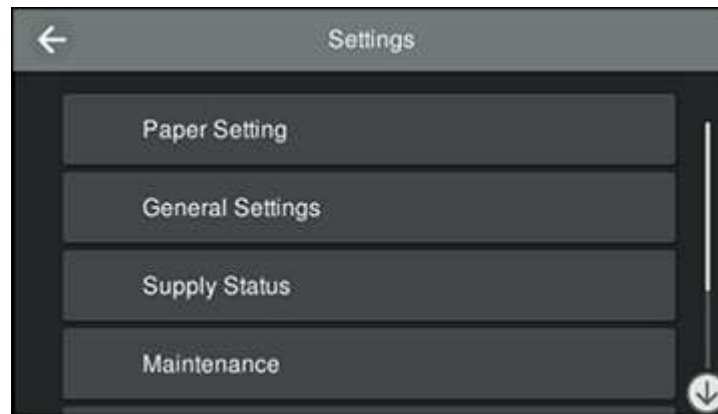

3. Press the up or down arrow to scroll through the menus, or swipe up or down on the LCD screen.

Note: To return to the previous screen, press the left arrow.

4. Press the up or down arrow to move through the settings, or swipe up or down on the LCD screen.
5. To select a setting, press the setting name. You can also select a setting to toggle it on or off, as shown below.

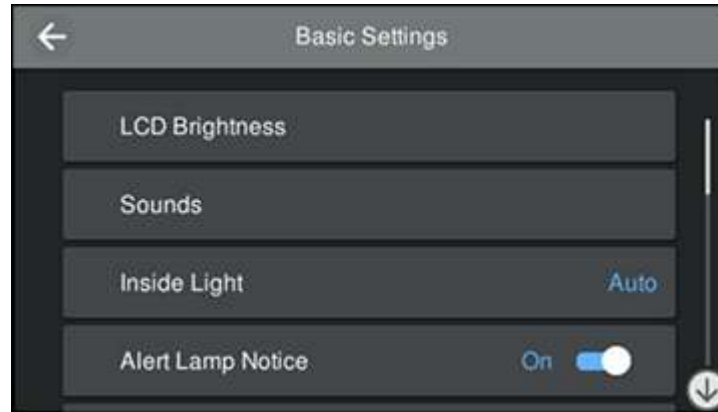

6. When you finish changing settings on a menu, press the left arrow to return to the previous menu or press the  home button to exit the menu system.

Parent topic: [Using the Control Panel Menus](#)

Paper Setting Menu

Select **Paper Setting** to customize paper options.

Roll Paper menu

Setting	Options	Description
Remove	—	Rewinds the loaded roll paper until it is ejected from the paper feeder

Setting	Options	Description
Feed/Cut Paper	Backward Forward Cut	Moves the paper backward or forward, or cuts it using the built-in cutter
Prepare for take-up	—	Readies the auto take-up reel to accept roll paper. Only available if the auto take-up reel is installed.
Print Adjustments	Paper Feed Adjust	Select Quality First to automatically adjust the paper feed for image quality Select Length Accuracy First if you are printing images that require more precise dimensions and length, such as CAD files
	Print Head Alignment	Select Uni-D Alignment to align the print head for uni-directional printing Select Bi-D Alignment to align the print head for bi-directional printing For each alignment setting, select the following: <ul style="list-style-type: none"> • Select Auto to automatically align the print head • Select Manual if an error appears during automatic alignment or if you are not satisfied with the results of the automatic alignment Automatic alignment takes 9 to 35 minutes, depending on the selected alignment type
Advanced Paper Settings	Various options	See the Advanced Paper Settings table below
Remaining Amount Management	Remaining Amount Management	Select On to display and record the amount of remaining roll paper
	Remaining Amount	Select the amount of roll paper remaining
	Remaining Alert	Select the amount of remaining roll paper before a warning is displayed

Setting	Options	Description
Change Paper Type/Paper Width	Paper Type	Select a paper category and paper type
	Paper Width	Select the width of the loaded paper, or select User-Defined if the width is not listed (only available for custom paper types when Paper Size Check is disabled)

Advanced Paper Settings menu (in the **Roll Paper** menu)

Setting	Options	Description
Confirm ICC Profile	—	Displays the ICC profile name; available when you connect the optional PostScript print server and select a custom paper type
Confirm Color Density	—	Displays the color density; available when you connect the optional PostScript print server and select a custom paper type
Paper Thickness	0.01 to 1.50 mm or 0.4 to 59.1 mil	Select the thickness of the roll paper; displayed when using a custom paper type
Platen Gap	Auto 1.2 1.6 1.9 2.1 2.4	Select the distance between the print head and the paper; displayed when using a custom paper type
Top Margin	3 mm 15 mm 20 mm 45 mm	Select the margin for the leading edge of the printed image. Depending on the paper type and printing environment, colors may be uneven near the leading edge if the margin is small.
Bottom Margin	3 mm 15 mm	Select the margin for the trailing edge of the printed image

Setting	Options	Description
Margin Between Pages	Standard 6 mm 30 mm 65 mm	<p>The Standard margins between pages are 15 mm for the top and bottom.</p> <p>For the following paper types, the Standard top and bottom margins are 20 mm:</p> <ul style="list-style-type: none"> • Epson Premium Glossy Photo Paper (250) • Epson Premium Semigloss Photo Paper (250) • Epson Premium Luster Photo Paper (260) • Epson Premium Semimatte Photo Paper (250) <p>For Epson UltraSmooth Fine Art Paper, the Standard top margin is 45 mm.</p> <p>Select a different value as necessary.</p> <p>Left and right margins are always 3 mm, except when printing a borderless image.</p>
Paper Suction	-4 to +3	Select to adjust the printer's suction setting; choose lower values for thinner papers
Back Tension	Standard High Extra High	Select to adjust the paper feeding tension; choose High or Extra High if paper wrinkles during printing
Drying Time	Drying Time per Pass	Select from 0 to 10 seconds for the amount of time the print head pauses to allow drying after each pass
	Drying Time per Page	Select from 0 to 60 minutes for the amount of time the printer pauses to allow drying after each page is printed
Paper Size Check	On Off	<p>Select On to detect the paper width when paper is loaded.</p> <p>Select Off if a paper setting error occurs when paper is correctly loaded. This allows you to set the paper width before feeding the paper.</p>

Setting	Options	Description
Auto Cut	Follow Paper Source Settings Never Cut	Select Follow Paper Source Settings to follow the cut settings in Printer Settings > Paper Source Settings > Roll Paper Setup > Cut Settings , or select Never Cut to cut paper manually
Skew Reduction	On Off	Select On to enable paper skew reduction
Roll Core Diameter	2inch 3inch	Select the paper core size for the loaded roll paper
Lateral Feed Adjustment	On Off	Select On to correct differences between the left and right sides of the paper feed
Paper Eject Roller	Auto Use Do Not Use	Select to control the paper ejection roller; select Auto to use the roller automatically depending on the type of Epson paper; select Use to always use the roller to eject paper; select Do Not Use when you are concerned about damaging the print surface
Paper Feed Offset	-1.0 to 1.53%	Select the amount of offset necessary to reduce banding on uneven color in printouts; displayed when using a custom paper type.
Restore Default Settings	—	Restores advanced paper settings to their default values; not available with custom paper types

Caution: If the **Paper Size Check** setting is set to **Off**, the printer may print beyond the edges of the paper, causing ink to get on the printer.

Cut Sheet menu

Setting	Options	Description
Remove	—	Ejects the loaded cut sheet

Setting	Options	Description
Print Adjustments	Paper Feed Adjust	Select Quality First to automatically adjust the paper feed for image quality Select Length Accuracy First if you are printing images that require more precise dimensions and length, such as CAD files
	Print Head Alignment	Select Uni-D Alignment to align the print head for uni-directional printing Select Bi-D Alignment to align the print head for bi-directional printing For each alignment setting, select the following: <ul style="list-style-type: none"> • Select Auto to automatically align the print head • Select Manual if an error appears during automatic alignment or if you are not satisfied with the results of the automatic alignment Automatic alignment takes 9 to 35 minutes, depending on the selected alignment type
Advanced Paper Settings	Various options	See the Advanced Paper Settings table below
Change Paper Type/Paper Size	Paper Type	Select a paper category and paper type
	Paper Size	Select a paper size or select User-Defined if your desired size is not listed

Advanced Paper Settings menu [in the **Cut Sheet** menu]

Setting	Options	Description
Check ICC Profile Name	—	Displays the ICC profile name; available when you connect the optional PostScript print server and select a custom paper type

Setting	Options	Description
Check Color Density	—	Displays the color density; available when you connect the optional PostScript print server and select a custom paper type
Thickness	0.01 to 1.50 mm or 0.4 to 59.1 mil	Sets the thickness of the paper; displayed when using a custom paper type
Platen Gap	Auto 1.2 1.6 1.9 2.1 2.4	Select the distance between the print head and the paper; displayed when using a custom paper type
Paper Suction	–4 to +3	Select to adjust the printer's suction setting; choose lower values for thinner papers
Drying Time	Drying Time per Pass	Select from 0 to 10 seconds for the amount of time the print head pauses to allow drying after each pass
	Drying Time per Page	Select from 0 to 60 minutes for the amount of time the printer pauses to allow drying after each page is printed
Paper Size Check	On Off	Select On to detect the paper width when paper is loaded. Select Off if a paper setting error occurs when paper is correctly loaded.
Skew Reduction	On Off	Select On to enable paper skew reduction
Paper Eject Roller	Auto Use Do Not Use	Select to control the paper ejection roller; select Auto to use the roller automatically depending on the type of Epson paper; select Use to always use the roller to eject paper; select Do Not Use when you are concerned about damaging the print surface

Setting	Options	Description
Paper Feed Offset	-1.0 to 1.53%	Select the amount of offset necessary to reduce banding on uneven color in printouts; displayed when using a custom paper type.
Restore Default Settings	—	Restores advanced media settings to their default values; not available with custom paper types

Caution: If the **Paper Size Check** setting is set to **Off**, the printer may print beyond the edges of the paper, causing ink to get on the printer.

Poster Board menu

Setting	Options	Description
Remove	—	Ejects the loaded poster board
Print Adjustments	Paper Feed Adjust	Select Image Accuracy First to automatically adjust the paper feed for image quality Select Length Accuracy First if you are printing images that emphasize dimensions and length such as CAD files.
	Print Head Alignment	Select Uni-D Alignment to align the print head for uni-directional printing Select Bi-D Alignment to align the print head for bi-directional printing For each alignment setting, you can select automatic or manual alignment. Select Auto to automatically align the print head Select Manual if an error appears during automatic alignment or if you are not satisfied with the results of the automatic alignment Note: The automatic alignment takes 9 to 35 minutes, based on the selected alignment type.

Setting	Options	Description
Advanced Paper Settings	Various options	See the Advanced Paper Setting table below
Change Paper Type/Paper Size	Media Type	Select a paper category and paper type
	Paper Size	Select a paper size or select User-Defined if your desired size is not listed

Advanced Paper Settings menu (in the **Poster Board** menu)

Setting	Options	Description
Check ICC Profile Name	—	Displays the ICC profile name; available when you connect the optional PostScript print server and select a custom paper type
Check Color Density	—	Displays the color density; available when you connect the optional PostScript print server and select a custom paper type
Thickness	0.01 – 1.50 mm	Sets the thickness of the paper; displayed for custom paper settings
Paper Suction	-4 to +3	Select to adjust the printer's suction setting; choose lower values for thinner papers
Drying Time	Drying Time per Pass	Select from 0 to 10 seconds for the amount of time the print head pauses to allow drying after each pass
	Drying Time per Page	Select from 0 to 60 minutes for the amount of time the printer pauses to allow drying after each page is printed
Paper Size Check	On Off	Select On to detect the paper width when paper is loaded. Select Off if a paper setting error occurs when paper is correctly loaded.
Skew Reduction	On Off	Select On to enable paper skew reduction

Setting	Options	Description
Paper Feed Offset	-1.0 to 1.53%	Select the amount of offset necessary to reduce banding on uneven color in printouts; displayed when using a custom paper type.
Restore Default Settings	—	Restores advanced media settings to their default values; not available with custom paper types

Caution: If the **Paper Size Check** setting is set to **Off**, the printer may print beyond the edges of the paper, causing ink to get on the printer.

Parent topic: [Using the Control Panel Menus](#)

Basic Settings Menu

Select **Menu** > **General Settings** > **Basic Settings** to customize various display and power settings.

Setting	Options	Description
LCD Brightness	1 to 9	Adjusts LCD screen brightness
Sounds	Button Press	Adjusts the volume of control panel sounds
	Paper Set	Adjusts the volume of load paper alerts
	Completion Notice	Adjusts the volume of print completion notification
	Error Notice	Adjusts the volume of error notifications
	Sound Type	Adjusts the type of control panel sounds
Inside Light	Auto Manual	Adjusts the behavior of the internal light. Set to Auto to turn the light on when a print job is running. Select Manual to use the ☀ icon on the LCD screen to turn the light on or off.

Setting	Options	Description
Alert Lamp Notice	On Off	Enables or disables the alert lamp notice
Sleep Timer	1 to 60 minutes	Selects the amount of time before the printer enters sleep mode
Power Off Timer	Various times Off	Selects the amount of time before the printer turns off automatically
Circuit Breaker Interlock Startup	On Off	Selects whether to turn the printer on or off when the circuit breaker switch is turned on
Date/Time Settings	Date/Time	Enters the date and time
	Daylight Savings Time	Select whether daylight savings is active. If your area does not observe daylight savings time, choose Winter .
	Time Difference	Sets the time difference for coordinated universal time (UTC)
Language	Various languages	Selects the language used on the LCD screen
Screen Customization	Background Color	Changes the color of the Home screen
	Print Screen	Switches the Home screen between Simple and Professional mode
Operation Time Out	On Off	Select On to return to the Home screen after 90 seconds of inactivity
Keyboard	Various	Sets the keyboard layout
Length Unit	m ft/in	Selects the unit of length displayed on the LCD screen
Default Screen (Jobs/Status)	Job Status Log Printer Status	Selects the information shown by default on the Status screen Job Status is available only if the optional print server is connected.

Parent topic: [Using the Control Panel Menus](#)

Printer Settings Menu

Select **Menu > General Settings > Printer Settings** to customize paper and printing options.

Setting	Options	Description
Paper Source Settings	Various options	See the Paper Source Settings table below
Custom Paper Setting	1 to 30	See the Custom Paper Setting table below
Auto Cleaning	On Off	Select the option to automatically perform a print head check and cleaning when the printer turns on and before printing; selecting Off disables the print head checking and automatic cleaning
	Standard	
	Custom	Sets the timing and frequency of automatic cleaning Nozzle Check Schedule: Sets whether to perform a nozzle check during printing or only after printing has finished Nozzle Check Sensitivity: Adjusts the number of clogged nozzles that trigger a cleaning cycle Nozzle Check Result Notice: Sets whether the printer reports if there are still clogged nozzles after automatic cleaning
Printing Language	USB Network	Select the printing language to use for each connection mode (available only when the optional PostScript print server is connected) Auto: select for most printing situations PS3: select if PS3 print data does not automatically switch the printing mode
PS Settings	Various options	See the PS Settings table below
Print Nozzle Check Pattern During Print	Every Pages Off	Sets whether to print a nozzle check pattern before the printer prints each page

Setting	Options	Description
Store Held Job	On Off	Select On to hold print jobs when an error occurs. Held jobs can be resumed by selecting the Information icon > Job Status menu. Available only when the optional print server is connected
PC Connection via USB	Enable Disable	Select whether to Enable or Disable access to the printer from a USB-connected computer
USB I/F Timeout Setting	20 to 600 seconds	Specifies the length of time before ending communication from a USB-connected computer; available only when the optional print server is connected

Paper Source Settings

Setting	Options	Description
Roll Paper Setup	Auto Loading	Automatically feeds roll paper into the printer
	Cut Settings	
	Auto Cut	Automatically cuts the roll paper after printing
	Print Cutting Guideline	Select On to print cut lines on roll paper (if Auto Cut is turned off)
	Wait for Cut Between Pages	Select On to pause before cutting pages after printing
	Cut for Borderless Print	Select Two Cuts to insert a margin and cut twice between pages; or One Cut to cut once between pages
	Quick Cut	Select On to cut once between pages while the next page is still printing
	Cut Mode	Select Quiet to reduce the speed and noise when cutting paper
	Refresh Margin	Select On to automatically remove ink stains from a previous borderless print by trimming the leading edge of the paper
	Roll End Option	Selects the action when roll paper runs out and you load more paper. Continue: Prints the remaining data Stop Printing: Does not print the remaining data Reprint: Restarts the print job from the beginning; available if the optional print server is connected
Take-up After Cut	Stores the print on the Auto Take-up Reel (if installed) after cutting it off the roll	
Error Notice	Paper Size Notice Paper Type Notice Detect Paper Meandering	Select On to display an error message when the output size or paper type settings differ between the driver and printer, or if the paper is skewed

Setting	Options	Description
Platen Gap Offset	Standard Wide Wider Widest	Adjusts the distance between the print head and the paper

Custom Paper Setting

You can select individual paper settings for each registered custom paper setting (01 to 30).

Note: You cannot change individual paper settings for custom paper settings registered through the driver or other software.

Setting	Options	Description
Change Name	—	Use the on-screen keyboard to enter a name for the custom paper setting (this name is displayed in the Paper Type list)
Change Reference Paper	Various options	Select the media type for the paper closest to the one you are using
Advanced Paper Settings options		
Check ICC Profile Name	—	Displays the ICC profile name; available when the optional PostScript print server is connected
Check Color Density	—	Displays the color density; available when the optional PostScript print server is connected
Thickness	0.01 to 1.50 mm or 0.4 to 59.1 mil	Select the thickness of the roll paper; displayed when using a custom paper type

Setting	Options	Description
Platen Gap	Auto 1.2 1.6 1.9 2.1 2.4	Select the distance between the print head and the paper; displayed when using a custom paper type
Top Margin	3 mm 15 mm 20 mm 45 mm	Select the margin for the leading edge of the printed image Depending on the paper type and printing environment, colors may be uneven near the leading edge if the margin is small.
Bottom Margin	3 mm 15 mm	Select the margin for the trailing edge of the printed image
Margin Between Pages	Standard 6 mm 30 mm 65 mm	The Standard margins between pages are 15 mm for the top and bottom. For the following paper types, the Standard top and bottom margins are 20 mm: <ul style="list-style-type: none"> • Epson Premium Glossy Photo Paper (250) • Epson Premium Semigloss Photo Paper (250) • Epson Premium Luster Photo Paper (260) • Epson Premium Semimatte Photo Paper (250) For Epson UltraSmooth Fine Art Paper, the Standard top margin is 45 mm. Select a different value as necessary. Left and right margins are always 3 mm, except when printing a borderless image.
Paper Suction	-4 to +3	Select to adjust the printer's suction setting; choose lower values for thinner papers

Setting	Options	Description
Back Tension	Standard High Extra High	Select High or Extra High if paper wrinkles during printing
Drying Time	Drying Time per Pass	Select from 0 to 10 seconds for the amount of time the print head pauses to allow drying after each pass
	Drying Time per Page	Select from 0 to 60 minutes for the amount of time the printer pauses to allow drying after each page is printed
Paper Size Check	On Off	Select On to detect the paper width when paper is loaded. Select Off if a paper setting error occurs when paper is correctly loaded. Note: If this setting is set to Off , the printer may print beyond the edges of the paper, causing ink to get on the printer.
Auto Cut	Follow Paper Source Settings Never Cut	Select Follow Paper Source Settings to automatically cut roll paper after each page is printed depending on the paper source settings, or select Never Cut to cut paper manually
Skew Reduction	On Off	Select On to enable paper skew reduction
Roll Core Diameter	2-inch 3-inch	Sets the paper core size for the loaded roll paper
Lateral Feed Adjustment	On Off	Corrects differences between the left and right of the paper feed

Setting	Options	Description
Paper Eject Roller	Auto Use Do Not Use	Presses down on paper as it is ejected. Select Use if the print head strikes the paper. If you are printing on glossy paper, select Do Not Use to avoid damaging the paper surface.
Paper Feed Offset	-1.0 to 1.53%	Select the amount of offset necessary to reduce banding on uneven color in printouts; displayed when using a custom paper type.

PS Settings

Adjust these settings as necessary when printing PostScript data; available only when the optional PostScript Print Server is connected.

Setting	Options	Description
Version	—	Displays the PostScript/PDF version
Output Size	Various sizes	Select the size of the output paper
Margin Options	Normal	Does not adjust margins for the print job
	Clip By Margins	Adds the value selected for the page margin inside the hard clip area of the PS command in the data, or the size selected for the base output size
	Add Margins	Auto: Adds the value selected for the page margin outside the hard clip area of the PS command in the data Otherwise, adds the value selected for the page margin outside the size selected for the base output size (when set to a standard size)
Quality	Speed Normal Fine	Adjusts the speed and quality of the output
Color Mode	Color Black/White	Select the color in which you want to print

Setting	Options	Description
CMYK Simulation	—	Selects the CMYK colors you want to simulate when reproducing CMYK ink colors for an offset printer
RGB Source	Various options	Selects the RGB color definition to simulate when printing RGB data
Rendering Intent	Various options	Selects how to convert color spaces for various simulations
Black Point Compensation	On Off	Set to Off to darken shadows when converting from a wide color space to a narrow color space
Auto Rotate	On Off	Automatically rotates print data 90° to the right based on image size and paper width
Cache to Hard Disk	On Off	Select On if the print head stops frequently during PostScript printing
Save to HDD	Print and Save Print Only Save Only	Select if and how you want to save data for PostScript print jobs.
PS Error Sheet	On Off	Prints the error message when a PostScript error occurs
Optimize Edge Quality	On Off	Improves image quality at the edges of your print. Reduces print speed and increases the margin on the leading edge by 1.4 inches (35 mm).
PDF Rendering Level	Levels 1 to 5	Lower the setting level to correct PDF printing errors
Clear All Settings	—	Restores the PS Settings to their default values

Parent topic: [Using the Control Panel Menus](#)

Network Settings Menu

Select **Menu > General Settings > Network Settings** to configure your printer's network settings.

Setting	Options	Description
Network Status	Wired LAN Status	Displays current communication status and connection settings
	Print Status Sheet	Prints the current network connection information
Connection Check	—	Displays the network status and lets you print a connection check report.
Advanced	—	Displays advanced information, such as TCP/IP settings. You can enable or disable other network settings.

Parent topic: [Using the Control Panel Menus](#)

System Administration Menu

Select **Menu > General Settings > System Administration** to configure security settings and update firmware.

Setting	Options	Description
Security Settings	Admin Settings	<p>Lets you add or change the administrator password</p> <p>If you choose to add a password, set the Lock Setting to On to enable password entry for certain features and settings.</p>
	Password Encryption	<p>Encrypts the administrator password. The printer will restart to apply the setting.</p> <p>Caution: Do not turn the power off while the printer is restarting or you may damage your data and lose any printer settings you have selected. You will need to set the password again.</p>

Setting	Options	Description
Format Hard Disk	Non-Secure (Quick)	Deletes all information from the optional print server. Non-Secure (Quick): Deletes file management information for data on the hard disk. Select this option when you want to use the printer with a hard disk that has been used with other printers. Secure (Quick): Overwrites the entire hard disk with a random character pattern. However, it is possible that data could be recovered using a dedicated data recovery tool. Secure (Sanitizing): Overwrites data on the hard disk with random 00/FF data, and then checks it using an algorithm based on the U.S Department of Defense standard (DoD5220-22m). Select this option when you need to erase confidential data.
	Secure (Quick)	
Restore Default Settings	Secure (Sanitizing)	
	Network Settings	Select Yes to restore all network settings to their defaults
	Clear All Data and Settings	Select Yes to restore all settings to their defaults (except date/time, length unit, and language settings)

Parent topic: [Using the Control Panel Menus](#)

Maintenance Menu

Select **Menu** > **Maintenance** to run nozzle checks, cleaning cycles, and other maintenance operations.

Caution: Follow the instructions in the topic links below the table to use these menu settings correctly.

Setting	Description
Print Head Nozzle Check	Prints a nozzle check pattern so you can check for clogged nozzles
Head Cleaning	Perform if the nozzle check pattern has faint or missing areas
Power Cleaning	Perform if the nozzle check pattern still has faint or missing areas after performing a head cleaning several times
Remove Paper	Removes any scraps of paper that remain inside the printer
Ink Cartridge(s) Replacement	Moves the print head to the correct position so you can replace ink cartridges. Displays the ink cartridge replacement procedure.
Replace Maintenance Box	Displays the maintenance box replacement procedure
Replace Cutter	Displays the cutter replacement procedure
Adjust Cut Position	Shifts the position of the cut line
SProofer Setting	Displayed when the optional SpectroProofer is installed
Cleaning the Maintenance Parts	Moves the print head to the cleaning position for manual cleaning and displays instructions on the LCD screen
Keeping/Transporting Preparation	Discharges the ink and turns the printer off Keeping Preparation: Discharges ink to prevent freezing during storage Personal Transport Preparation: Discharges ink to prevent leaking during transportation

Parent topic: [Using the Control Panel Menus](#)

Related tasks

[Replacing the Cutter](#)

[Replacing the Borderless Pads](#)

[Moving or Transporting Your Product](#)

[Cleaning the Platen and Borderless Pad Edges](#)

[Wiping the Print Head](#)

[Cleaning the Print Head Cap Area](#)

[Checking the Nozzles Using the Product Control Panel](#)

[Cleaning the Print Head Using the Product Control Panel](#)

[Running a Power Cleaning Using the Product Control Panel](#)
[Aligning the Print Head Automatically Using the Product Control Panel](#)
[Aligning the Print Head Manually Using the Product Control Panel](#)

Status Menu

Select **Menu** > **Status** to view current printer and network settings.

Setting	Options	Description
Firmware Version	—	Displays the firmware version for the printer and any optional accessories connected to it
Hard Disk Unit	—	Displays the connection status for the optional print server
Adobe PS3 expansion unit	—	Displays the connection status for the optional PostScript print server
SpectroProofer	Calibration Tile S/N Device Temperature Air Temperature Backing Color	Displays information about the optional SpectroProofer
Auto Take-up Reel Unit	—	Displays information about the optional Auto Take-up Reel
Platen Gap Value for Last Print Job	—	Displays the platen gap value for the last print job
Network	Wired LAN Status	Displays the current communication status and connection settings
	Print Status Sheet	Prints the network status sheet

Parent topic: [Using the Control Panel Menus](#)

Replacing Ink Cartridges and Maintenance Boxes

If a message appears or the ⚠ icon appears above an ink color on the LCD screen, the cartridge is low or expended. When an ink cartridge is expended, printing stops and you need to replace the cartridge. You may also need to replace a cartridge that is more than six months old, or if your printouts do not look their best, even after cleaning and aligning the print head.

The maintenance box stores ink that gets flushed from the system during print head cleaning. If a message appears or the ⚠ icon appears above the maintenance box icon on the LCD screen, the amount of available space in the maintenance box is low. When the maintenance box is full, you need to replace it.

Note: Please dispose of your used Epson branded ink cartridges responsibly and in accordance with local requirements. If you would like to return your used ink cartridges to Epson for proper disposal, please go to [epson.com/recycle](https://www.epson.com/recycle) for more information.

[Purchase Epson Ink Cartridges and Maintenance Box](#)

[Removing and Installing Ink Cartridges](#)

[Replacing Maintenance Boxes](#)

Purchase Epson Ink Cartridges and Maintenance Box

You can purchase genuine Epson ink, maintenance boxes, and paper at [epson.com](https://www.epson.com) (U.S. sales), [epson.ca](https://www.epson.ca) (Canadian sales), or [epson.com.jm](https://www.epson.com.jm) (Caribbean sales). You can also purchase supplies from an Epson authorized reseller. To find the nearest one, call 800-GO-EPSON (800-463-7766) in the U.S. or 800-807-7766 in Canada.

Note: This product is designed to work with genuine Epson inks. Non-Epson ink or any other ink not specified for this printer could cause damage not covered by Epson's warranties.

[Ink Cartridge and Maintenance Box Part Numbers](#)

Parent topic: [Replacing Ink Cartridges and Maintenance Boxes](#)

Ink Cartridge and Maintenance Box Part Numbers

Use these part numbers when you order or purchase a new ink cartridge or maintenance box.

Note: For best printing results, use up a cartridge within one year of opening the package. Epson recommends removing and shaking the ink cartridges once every six months.

Maintenance box part number: T699700

Ink color	150 ml	350 ml	700 ml
Photo Black	T44W120	T44P120	T44H120
Cyan	T44W220	T44P220	T44H220
Vivid Magenta	T44W320	T44P320	T44H320
Yellow	T44W420	T44P420	T44H420
Light Cyan	T44W520	T44P520	T44H520
Vivid Light Magenta	T44W620	T44P620	T44H620
Gray	T44W720	T44P720	T44H720
Matte Black	T44W820	T44P820	T44H820
Light Gray	T44W920	T44P920	T44H920
Orange	T44WA20	T44PA20	T44HA20
Green	T44WB20	T44PB20	T44HB20
Violet	T44WD20	T44PD20	T44HD20

Parent topic: [Purchase Epson Ink Cartridges and Maintenance Box](#)

Removing and Installing Ink Cartridges

Make sure you have your replacement cartridges handy before you begin. You must install new cartridges immediately after removing the old ones. If you replace ink while printing, colors may look different depending on how the ink dries.

Note: Replace all expended ink cartridges. You cannot print if any of the ink cartridges are expended or any ink slots are empty.

1. Turn on your product.

2. Open the ink cartridge cover.

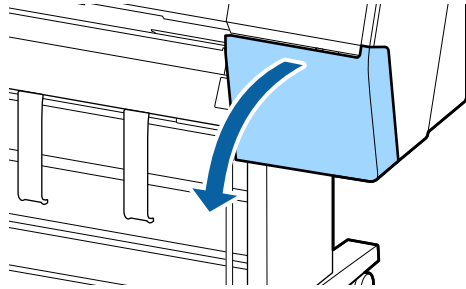

3. Pull out the ink cartridge.

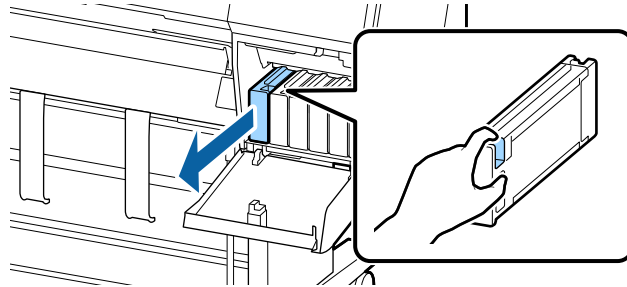

Note: Dispose of used cartridges carefully. Do not take the used cartridge apart or try to refill it.

Warning: If ink gets on your skin, wash it thoroughly with soap and water. If ink gets into your eyes, flush them immediately with water. If ink gets into your mouth, spit it out and see a doctor right away. Keep ink cartridges out of the reach of children.

4. Remove the new cartridge from the package. Gently shake the cartridge about 4 inches (10 cm) horizontally 30 times for about 10 seconds.

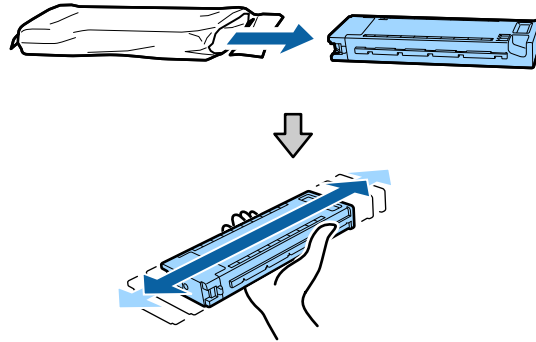

Caution: Do not touch the green chip on the cartridge.

5. Insert the new cartridge into the corresponding ink slot.

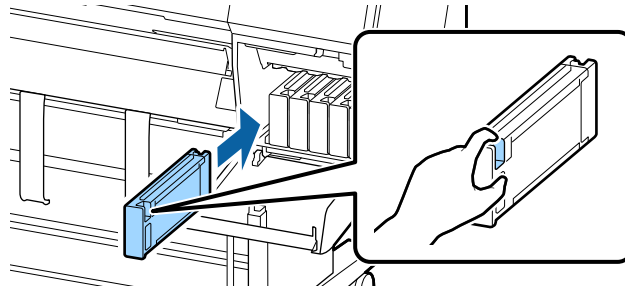

6. Repeat the above steps for any other cartridge that needs to be replaced.

7. Close the ink cartridge cover.

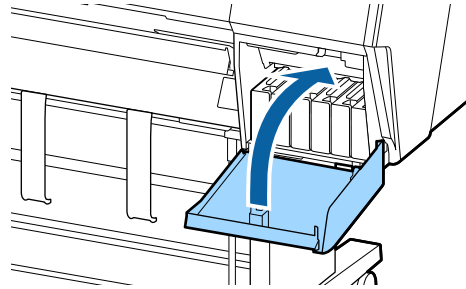

Your product begins charging the ink delivery system.

Note: Do not turn off the product during ink charging.

Caution: If you remove an ink cartridge for later use, protect the ink supply area from dirt and dust and store it in the same environment as the printer. The valve in the ink supply port is designed to contain any excess ink, but do not touch the ink supply port or surrounding area. Always store ink cartridges with the label facing up; do not store cartridges upside-down.

Parent topic: [Replacing Ink Cartridges and Maintenance Boxes](#)

Related concepts

[Purchase Epson Ink Cartridges and Maintenance Box](#)

Replacing Maintenance Boxes

The maintenance box absorbs ink used in maintenance operations such as head cleaning. Replace the maintenance box when you see a message on the LCD screen. (The SureColor P9500 Series has two maintenance boxes.)

Note: Do not reuse maintenance boxes you have removed from the printer and exposed to air for a long period of time. The box will not absorb any more ink.

1. Check the LCD screen to determine which maintenance box needs to be replaced (SureColor P9500 Series).

2. Remove the new maintenance box from the package.

Caution: Do not touch the chip on the side of the maintenance box or you may damage the product.

3. Use the handle on the bottom of the maintenance box to carefully pull it out of the product without tilting the box.

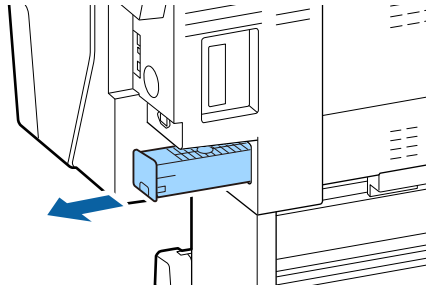

4. Place the used maintenance box in the bag supplied with the new box and seal the bag.

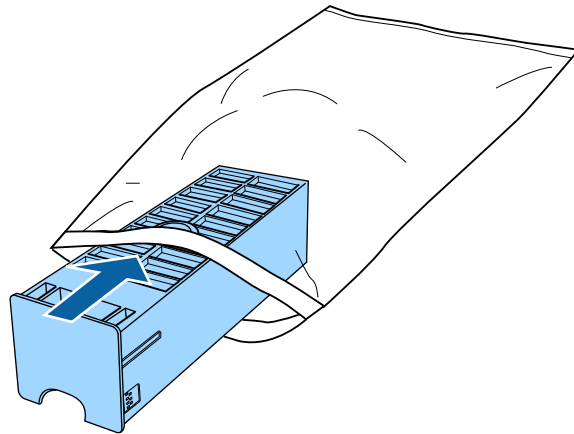

5. Insert the new maintenance box in the slot.

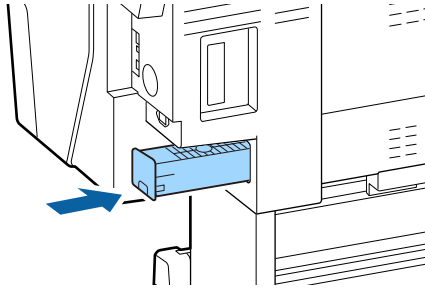

Parent topic: [Replacing Ink Cartridges and Maintenance Boxes](#)

Related concepts

[Purchase Epson Ink Cartridges and Maintenance Box](#)

Adjusting Print Quality

If your print quality declines, you may need to run a utility to clean or align the print head.

Note: To download the standard Epson printer software, visit epson.com/support (U.S.), epson.ca/support (Canada), or epson.com.jm/support (Caribbean) and select your product.

[Print Head Maintenance](#)

[Print Head Alignment](#)

[Adjusting the Paper Feed Using the Product Control Panel](#)

[Cleaning the Roll Paper Feeder](#)

Print Head Maintenance

If your printouts become too light, or you see dark or light bands across them, you may need to clean the print head nozzles. Cleaning uses ink, so clean the nozzles only if print quality declines.

You can check for clogged nozzles before you clean them so you don't clean them unnecessarily.

Note: You cannot clean the print head if ink is expended, and may not be able to clean it when ink is low.

[Print Head Nozzle Check](#)

[Print Head Cleaning](#)

Parent topic: [Adjusting Print Quality](#)

Related tasks

[Removing and Installing Ink Cartridges](#)

Print Head Nozzle Check

You can print a nozzle check pattern to check for clogged nozzles.

[Checking the Nozzles Using the Product Control Panel](#)

[Checking the Nozzles Using a Computer Utility](#)

Parent topic: [Print Head Maintenance](#)

Checking the Nozzles Using the Product Control Panel

You can check the print head nozzles using the control panel on your product.

1. Load roll or cut sheet paper in the printer.
2. Make sure the correct paper type is selected.
3. Select **Menu > Maintenance > Print Head Nozzle Check**.
4. Select **Start**.
The nozzle pattern prints.
5. Check the printed pattern to see if there are gaps in the lines.

Print head is clean

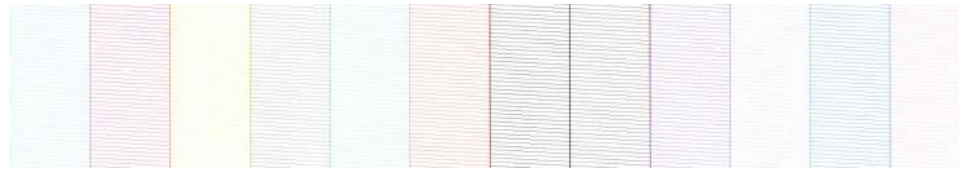

Print head needs cleaning



6. Do one of the following:
 - If there are no gaps, select **O** to exit.
 - If there are gaps or the pattern is faint, select **X** to perform head cleaning.
7. Follow the instructions on the screen to clean the print head, check the nozzles, and repeat the process as necessary.

Parent topic: [Print Head Nozzle Check](#)

Related references



[Maintenance Menu](#)

Related tasks

[Cleaning the Print Head Using the Product Control Panel](#)

Checking the Nozzles Using a Computer Utility

You can check the print head nozzles using a utility on your Windows or Mac computer.

1. Load roll or cut sheet paper in the printer.
2. Make sure the correct paper type is selected.
3. Do one of the following:
 - **Windows:** Access the Windows Desktop and right-click the  icon for your product in the right side of the Windows taskbar, or click the up arrow and right-click .
 - **Mac:** In the Apple menu or the Dock, select **System Preferences**. Select **Print & Fax**, **Print & Scan**, or **Printers & Scanners**, select your product, and select **Options & Supplies**. Select **Utility** and select **Open Printer Utility**.
4. Select **Nozzle Check**.

You see a window like this:

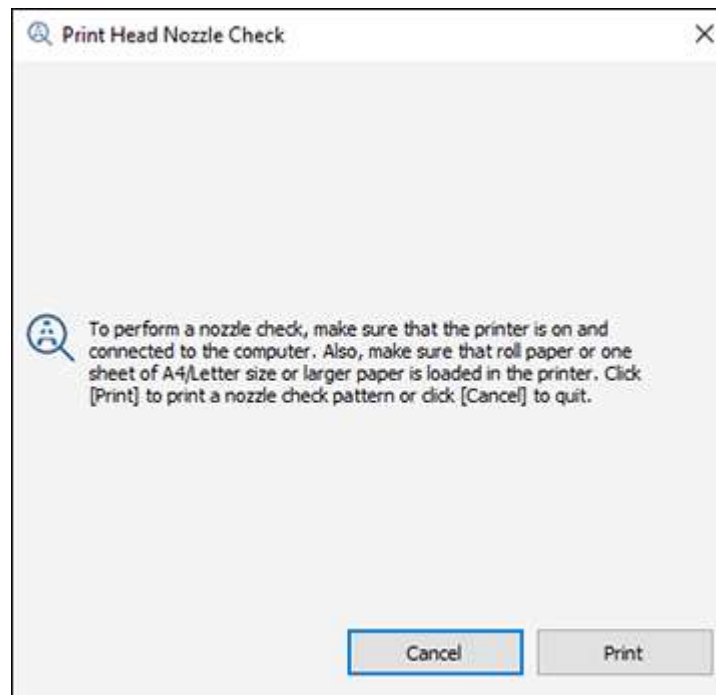

5. Click **Print**.
The nozzle pattern prints.

6. Check the printed pattern to see if there are gaps in the lines.

Print head is clean



Print head needs cleaning



7. If there are no gaps, click **Finish**.

If there are gaps or the pattern is faint, clean the print head.

Parent topic: [Print Head Nozzle Check](#)

Related tasks

[Cleaning the Print Head Using a Computer Utility](#)

Print Head Cleaning

If print quality has declined and the nozzle check pattern indicates clogged nozzles, you can clean the print head.

Note: When **Auto Cleaning** is enabled, the nozzles are checked after head cleaning and, if clogging is detected, auto cleaning is performed. Depending on the status of the nozzles, this process can take up to 32 minutes.

Note: You cannot clean the print head if an ink cartridge is expended, and may not be able to clean it when a cartridge is low. You must replace the cartridge first.

[Cleaning the Print Head Using the Product Control Panel](#)

[Cleaning the Print Head Using a Computer Utility](#)

[Running a Power Cleaning Using the Product Control Panel](#)

Parent topic: [Print Head Maintenance](#)

Cleaning the Print Head Using the Product Control Panel

You can clean the print head using the control panel on your product.

Note: Consider the following when preparing to clean the print head:

- Ink is consumed during print head cleaning. Clean the print head only if the print quality declines.
- Cleaning all nozzles uses ink from all colors.
- Prepare a new maintenance box if the current maintenance box is low on space. Because ink used during cleaning does not evaporate quickly, repeated head cleanings can fill the maintenance box.
- You cannot clean the print head if the temperature conditions are not within specifications. See the link below.

1. Load roll or cut sheet paper in the printer.
2. Make sure the correct paper type is selected.
3. Select **Menu > Maintenance > Head Cleaning**.
4. Select one of the following:
 - To clean all nozzles, select **All Colors** and press the right arrow.
 - To clean specific nozzles, select them.
5. Select **OK** to start the cleaning cycle.
When the cleaning cycle is finished, a confirmation screen appears.

Caution: Never turn off the product during a cleaning cycle or you may damage it.

6. Select **Yes** to print a nozzle check pattern.

7. Check the printed pattern to see if there are gaps in the lines.

Print head is clean



Print head needs cleaning



8. Follow the instructions on the screen to clean the print head, check the nozzles, and repeat the process as necessary.

If you don't see any improvement after cleaning the print head several times, run a Power Cleaning.

Parent topic: [Print Head Cleaning](#)

Related references

[Environmental Specifications](#)

[Maintenance Menu](#)

Related tasks

[Running a Power Cleaning Using the Product Control Panel](#)

[Removing and Installing Ink Cartridges](#)



[Checking the Nozzles Using the Product Control Panel](#)

Cleaning the Print Head Using a Computer Utility

You can clean the print head using a utility on your Windows computer or Mac.

Note: Consider the following when preparing to clean the print head:

- Ink is consumed during print head cleaning. Clean the print head only if the print quality declines.

- Cleaning all nozzles uses ink from all colors.
 - Prepare a new maintenance box if the current maintenance box is low on space. Because ink used during cleaning does not evaporate quickly, repeated head cleanings can fill the maintenance box.
 - You cannot clean the print head if the temperature conditions are not within specifications. See the link below.
1. Load roll or cut sheet paper in the printer.
 2. Make sure the correct paper type is selected.
 3. Do one of the following:
 - **Windows:** Access the Windows Desktop and right-click the  icon for your product in the right side of the Windows taskbar, or click the up arrow and right-click .
 - In the Apple menu or the Dock, select **System Preferences**. Select **Print & Fax**, **Print & Scan**, or **Printers & Scanners**, select your product, and select **Options & Supplies**. Select **Utility** and select **Open Printer Utility**.
 4. Select **Head Cleaning**.

You see a window like this:

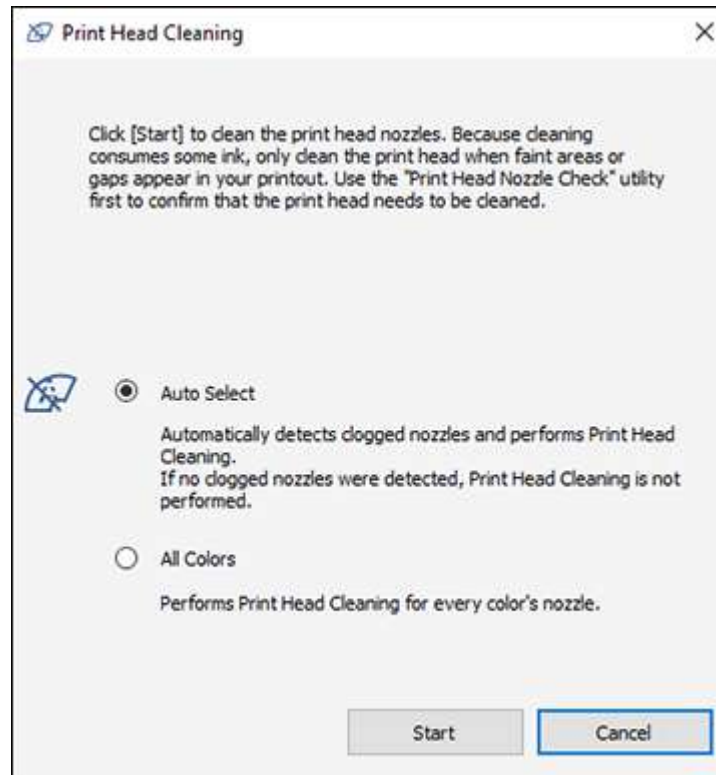

5. Select the type of cleaning you want to perform.

6. Click **Start** to begin the cleaning cycle.

The power light begins flashing. When the cleaning cycle is finished, the power light stops flashing and a confirmation screen appears.

Caution: Never turn off the product during a cleaning cycle or you may damage it.

7. Click **Nozzle Check**.

8. Click **OK**.

The nozzle pattern prints.

9. Check the printed pattern to see if there are gaps in the lines.

Print head is clean



Print head needs cleaning



If you don't see any improvement after cleaning the print head several times, run a Power Cleaning.

Parent topic: [Print Head Cleaning](#)

Related references

[Environmental Specifications](#)

[Maintenance Menu](#)

Related tasks

[Running a Power Cleaning Using the Product Control Panel](#)

[Removing and Installing Ink Cartridges](#)

[Checking the Nozzles Using a Computer Utility](#)

Running a Power Cleaning Using the Product Control Panel

If print head nozzles are still clogged after cleaning the print head several times, run the **Power Cleaning** utility from the product control panel. This process consumes a lot of ink to clean the clogged nozzles.

1. Load roll or cut sheet paper in the printer.
2. Make sure the correct paper type is selected.
3. Press the  home button, if necessary.

4. Select **Menu > Maintenance > Power Cleaning**.

You see a screen like this:

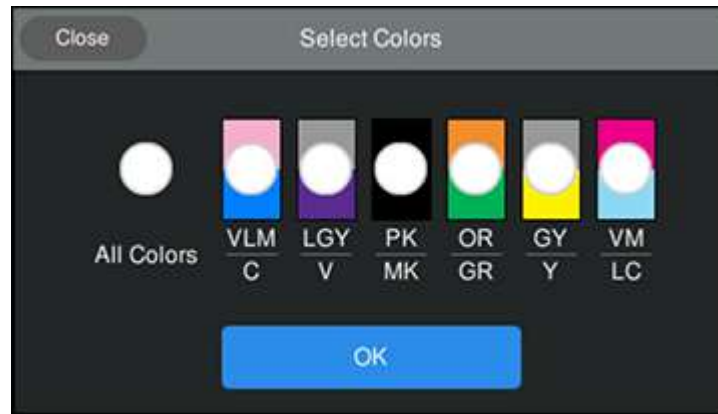

5. Select the nozzle pairs you want to clean or select **All Colors** and select **OK** to begin the power cleaning cycle.

Caution: Never turn off the product during a cleaning cycle or you may damage it.

6. Select **Yes** to print a nozzle check pattern.
The nozzle pattern prints.

7. Check the printed pattern to see if there are gaps in the lines.

Print head is clean



Print head needs cleaning



If nozzles are still clogged, turn off the printer and leave it off overnight. If nozzles are still clogged when you turn it back on and run a nozzle check, contact Epson for support.

Parent topic: [Print Head Cleaning](#)

Print Head Alignment

If your printouts become grainy or blurry, you notice misalignment of vertical lines, or you see dark or light horizontal bands, you may need to align the print head.

Before you align the print head, note the following:

- Alignment varies depending on the loaded media. Align the print head using the media on which you want to print and select the correct paper type as the **Paper Type** setting.
- Run a nozzle check before you align the print head. If there are any gaps in the nozzle check pattern, clean the print head.
- Manually align the print head on any transparent or colored paper or on these paper types: Plain paper, Epson Enhanced Matte Posterboard.

[Aligning the Print Head Automatically Using the Product Control Panel](#)

[Aligning the Print Head Manually Using the Product Control Panel](#)

Parent topic: [Adjusting Print Quality](#)

Aligning the Print Head Automatically Using the Product Control Panel

You can automatically align the print head using the control panel on your product. Make sure no direct sunlight enters the printer, or the alignment pattern may not be read correctly.

Note: You must manually align the print head when you are using any transparent or colored paper or on these paper types: Plain paper, Epson Enhanced Matte Posterboard.

1. Load roll paper or cut sheet paper in the printer.

Note: Load paper that is at least 15.2 inches (388 mm) wide.

2. Make sure the correct paper type is selected.

Note: If you are using commercially available paper, make sure you create the custom paper settings in advance.

3. Press the  home button, if necessary.
4. Select **Menu > Paper Setting**.

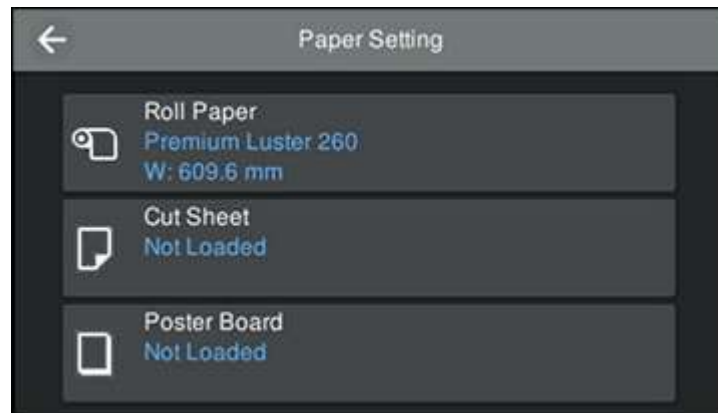

5. Select the option for the paper loaded in the printer.
6. Select **Print Adjustments > Print Head Alignment**.

7. Select one of the following:
 - **Uni-D Alignment:** aligns each color for uni-directional printing (takes 25 to 35 minutes to complete)
 - **Bi-D Alignment:** aligns each color for bi-directional printing (takes 9 to 13 minutes to complete)
8. Select **Auto**.
9. Select **Nozzle Check Pattern > Start** if you want to run a nozzle check before aligning the print head. If the nozzles are clogged, it may affect the automatic alignment.
10. After the nozzle check is complete, select **Auto Adjustment > Start**.

The sensor reads the adjustment pattern and automatically aligns the print head.

Note: Do not open the front cover or turn off the printer during the alignment process.

11. After the alignment is complete, check the results.

If the print head still seems misaligned, select a different alignment method and repeat the process. If your printer still is not properly aligned, perform a manual head alignment.

Parent topic: [Print Head Alignment](#)

Related tasks

[Loading Roll Paper](#)

[Loading Cut Sheets](#)

[Creating Custom Paper Settings](#)

[Aligning the Print Head Manually Using the Product Control Panel](#)

Aligning the Print Head Manually Using the Product Control Panel

If you cannot run an automatic print head alignment on your paper or automatic alignment does not correct the problem, you can manually align the print head using the control panel on your product.

1. Load roll paper or cut sheet paper in the printer.

Note: Load paper that is at least A4 (8.3 × 11.7 inches [210 × 297 mm]) in size.

2. Make sure the correct paper type is selected.

Note: If you are using commercially available paper, make sure you create the custom paper settings in advance.

3. Press the  home button, if necessary.
4. Select **Menu > Paper Setting**.

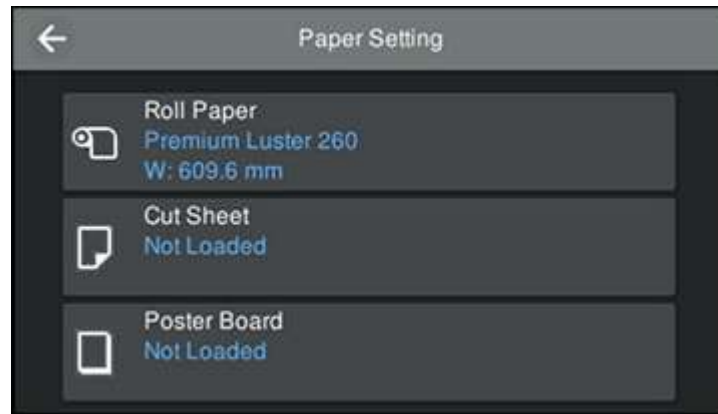

5. Select the option for the paper loaded in the printer.
6. Select **Print Adjustments > Print Head Alignment**.
7. Select one of the following:
 - **Uni-D Alignment:** aligns each color for uni-directional printing (takes 25 to 35 minutes to complete)
 - **Bi-D Alignment:** aligns each color for bi-directional printing (takes 9 to 13 minutes to complete)
8. Select **Manual** and select **Start**.

The printer prints the first adjustment pattern. If you are printing on cut sheets, load additional sheets of paper after each pattern is printed.
9. After each alignment pattern is printed, view the LCD screen for instructions on selecting the best result in each pattern set.

Multiple pattern sets may print, depending on the paper width. If so, check all pattern sets and average the adjustment value. For example, if two pattern sets print, and the best value for each set is 0 and 2, the average value would be 1. Enter 1 as the adjustment value. If the average value is not an integer, round it off to the nearest whole number.

Uni-D Alignment

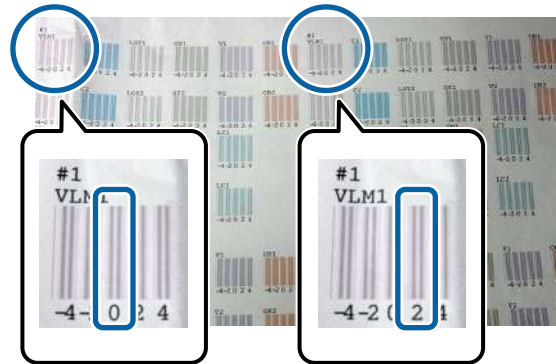

Bi-D Alignment

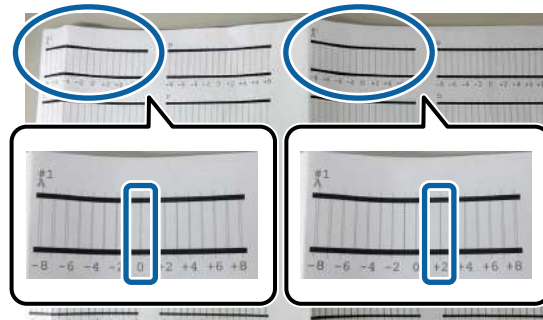

10. After the alignment is complete, check the results.

If the print head still seems misaligned, repeat the process.

Parent topic: [Print Head Alignment](#)

Related tasks

[Loading Roll Paper](#)

[Loading Cut Sheets](#)

[Creating Custom Paper Settings](#)

[Aligning the Print Head Automatically Using the Product Control Panel](#)

Adjusting the Paper Feed Using the Product Control Panel

If your printouts are grainy or blurry, or you see dark or light horizontal bands, you may need to adjust the paper feed using the product control panel.

1. Load roll paper or cut sheet paper in the printer.

Note: Load paper that is at least 15.7 inches wide by 22 inches long (400 mm × 560 mm).

2. Make sure the correct paper type is selected.
3. Press the  home button, if necessary.
4. Select **Menu > Paper Setting**.

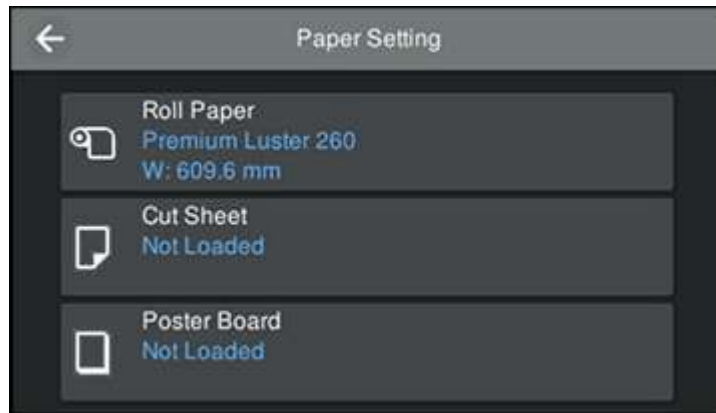

5. Select the option for the paper loaded in the printer.
6. Select **Print Adjustments > Paper Feed Adjust**.
7. Select one of the following:
 - **Quality First:** prints adjustment patterns to adjust the feed for image quality. Epson recommends running this option first.
 - **Length Accuracy First:** prints measurement positions to adjust the feed for images that require more precise dimensions and length



Note: You will need a 24-inch (610 mm) ruler that can measure in 0.5 mm increments to perform the adjustment.

8. Select **Start** to print an adjustment pattern.
 9. Depending on your adjustment selection, do one of the following:
 - **Quality First:** Follow the instructions on the LCD screen to select the best patterns for the first set of adjustment patterns and select **OK**.
After the second set of adjustment patterns prints, repeat the process.
 - **Length Accuracy First:** Use a ruler that can measure in 0.5 mm increments to measure the registration marks. Enter the measurement on the LCD screen and select **OK**.
- The screen displays a confirmation message and returns to the home screen.

Parent topic: [Adjusting Print Quality](#)

Cleaning the Roll Paper Feeder

If ink smears when printing on roll paper or cut sheets, you can clean the roll paper feeder using plain paper to remove excess ink.

1. Load the widest available roll paper in the printer.
2. Press the  home button, if necessary.
3. Select **Paper Setting > Roll Paper > Feed/Cut Paper**.
4. Select  and press and hold **Forward** until there are no ink smears on the ejected roll paper.
5. Select **Cut** to cut the roll paper.

Parent topic: [Adjusting Print Quality](#)

Maintenance and Transportation

See the instructions in these sections to maintain your printer for optimum results, or to move or transport your printer.

[Replacing the Cutter](#)

[Replacing the Borderless Pads](#)

[Cleaning the Platen and Borderless Pad Edges](#)

[Wiping the Print Head](#)

[Cleaning the Print Head Cap Area](#)

[Moving or Transporting Your Product](#)

Replacing the Cutter

If you notice that your paper does not cut cleanly, you may need to replace the cutter. You will need a Phillips-head screwdriver.

Caution: Do not remove the protective material from the new cutter until instructed to do so. Do not drop the cutter or knock it against anything or you may chip the blade.

Note: If the optional SpectroProofer accessory is mounted on the printer, you will have to remove the mount to replace the cutter. See the SpectroProofer manual for instructions on removal and installation.

1. Remove all paper from the printer.
2. Press the  home button, if necessary.
3. Select **Menu > Maintenance > Replace Cutter > Start**.
The cutter moves to the replacement position.

4. Press down on the knob of the cutter replacement cover and pull the cover down and towards you to remove it.

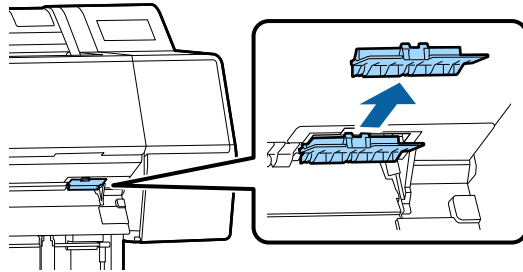

5. Use a Phillips-head screwdriver to loosen the screw holding the cutter in place and carefully remove the cutter. Place the cutter in a plastic bag and dispose of it properly.

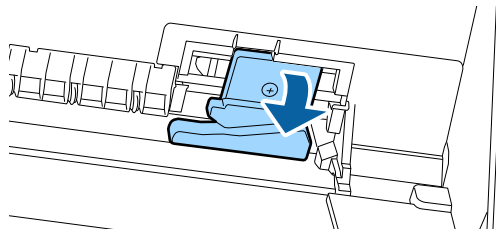
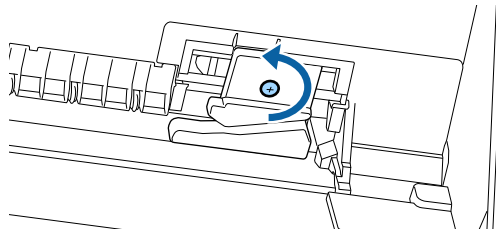

Warning: Keep the cutter out of the reach of children. The blade is sharp and can cause injury.

6. Insert the screw into the new cutter as shown and align it with the hole on the product.

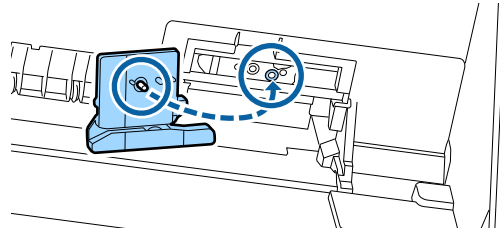

7. Tighten the cutter screw securely.

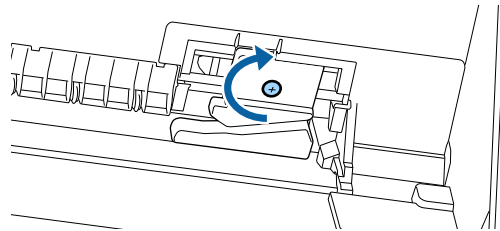

Note: Make sure the screw is tightened securely, otherwise the cut position may shift slightly.

8. Insert the base of the cutter replacement cover into the printer and push in the top part until it clicks into place.

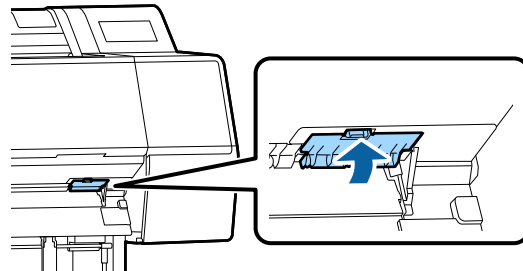

9. Select **OK**.
The cutter moves into position.

Parent topic: [Maintenance and Transportation](#)

Replacing the Borderless Pads

If you see ink smears on the back of your printouts, you may need to replace the pads for borderless printing. Only replace the borderless pads in the areas where you notice ink on your prints. You do not need to replace all of the borderless pads.

You need a Borderless Replacement Pad Kit (part number C13S210102) and a pair of tweezers to perform the replacement.

1. Turn off the product, wait for the LCD screen to turn off, and unplug the power cable from the electrical outlet.
2. Wait for one minute before continuing.
3. Open the front cover.

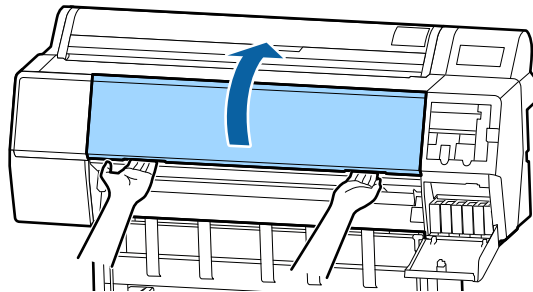

4. Using tweezers, pull out the borderless pads in the areas where ink transfer occurs.

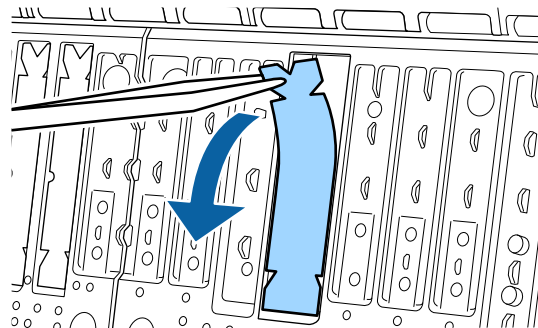

5. Use the cleaning sticks to wipe off the accumulated ink as shown in the following locations:

Bottom

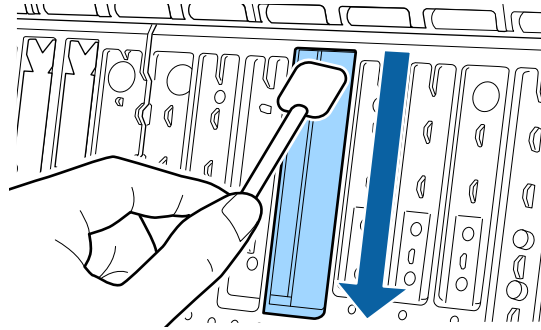

Sides

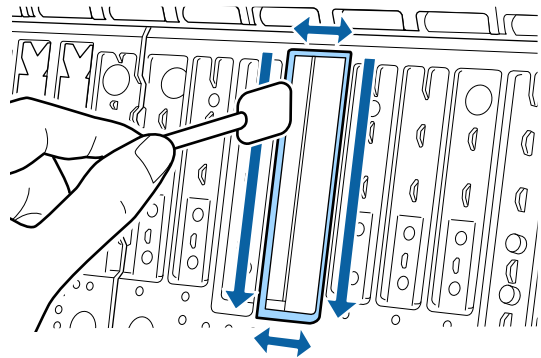

Center groove

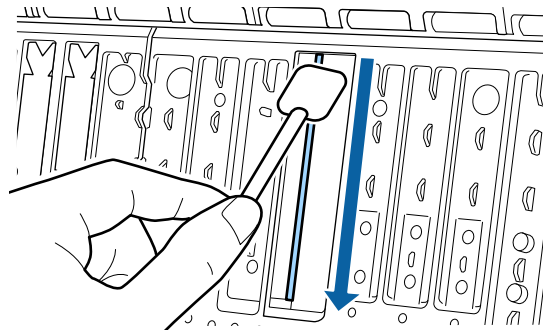

6. Bend the leg on a new borderless pad as shown below.

Note: Do not bend the borderless pad except at the area shown.

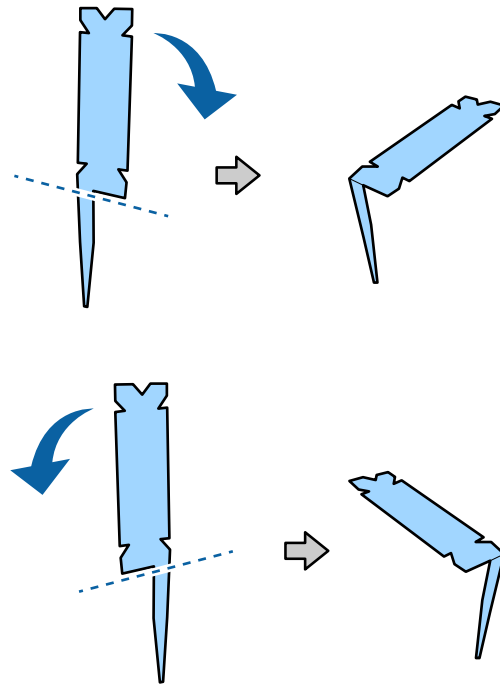

7. Insert the leg of the borderless pad all the way into the hole as shown.

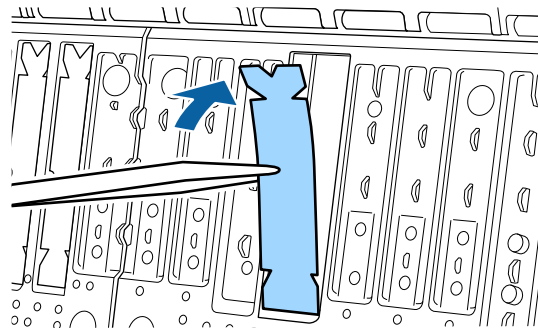
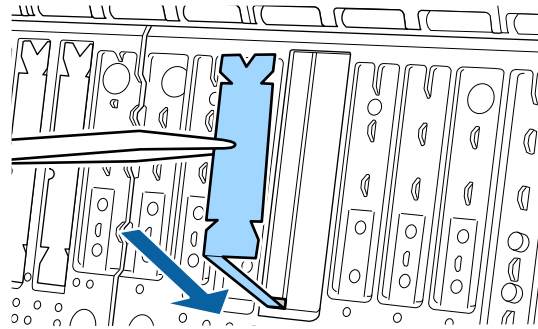

8. Push the protrusions on the sides of the borderless pad into the grooves on the left and right.

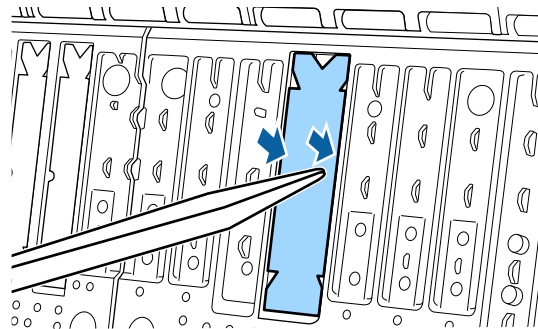

9. Gently press the borderless pad until it is seated in place.

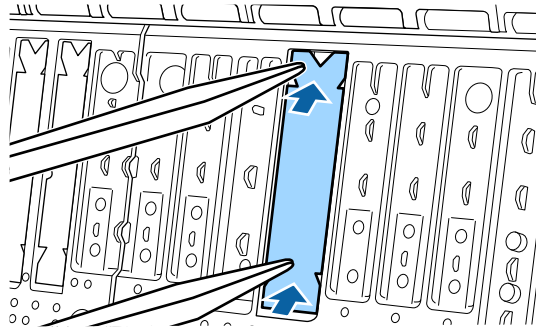

Caution: Make sure that no part of the borderless pad extends above the surrounding surface. The borderless pad may rub against the print head and damage it.

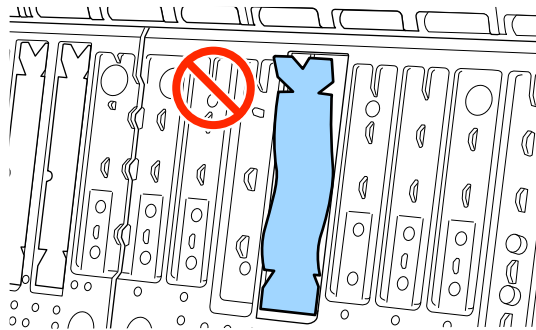

Parent topic: [Maintenance and Transportation](#)

Cleaning the Platen and Borderless Pad Edges

You should clean the interior of the printer about once a month to prevent ink and paper particles from accumulating in the printer. Carefully follow the steps here to clean the platen and borderless pad edges to remove ink, paper particles, and lint.

Caution: If ink remains on these parts, it could transfer to your printouts. Continued use of your product with ink, paper particles, or lint on these surfaces could damage the print heads or clog the nozzles.

1. Turn off the product, wait for the LCD screen to turn off, and unplug the power cable from the electrical outlet.
2. Wait for one minute before continuing.
3. Open the front cover.

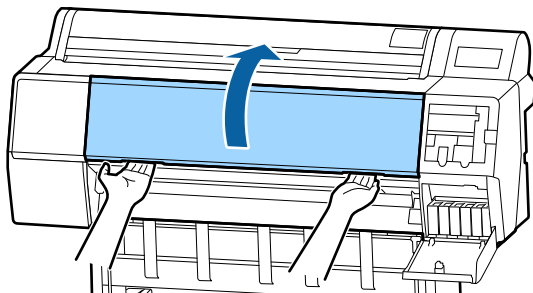

4. Use a soft, lint-free cloth to thoroughly remove dust and dirt from the platen as shown here. Wipe from the inside to the outside of the platen and do not touch the areas shown in gray.

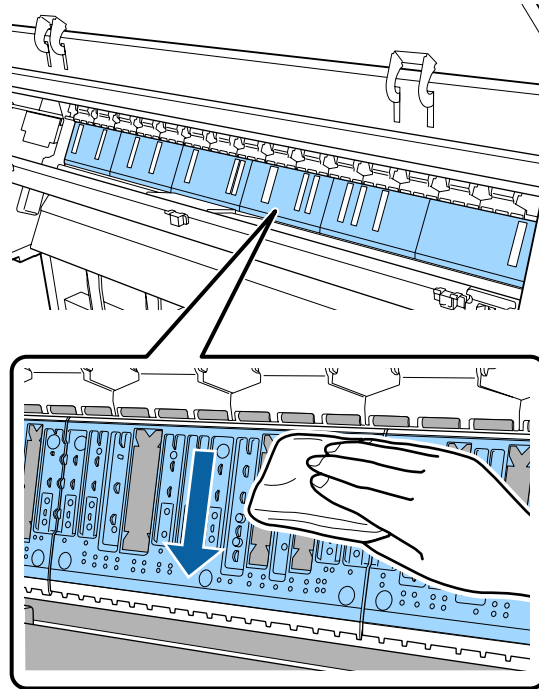

Note: For stubborn dirt, dampen a soft cloth with neutral detergent. Wring it out and clean the platen as shown. Dry the platen with a soft, dry, lint-free cloth when you are finished.

5. If any paper particles have accumulated in the holes shown here, use a pointed object such as a toothpick to push the material into the holes.

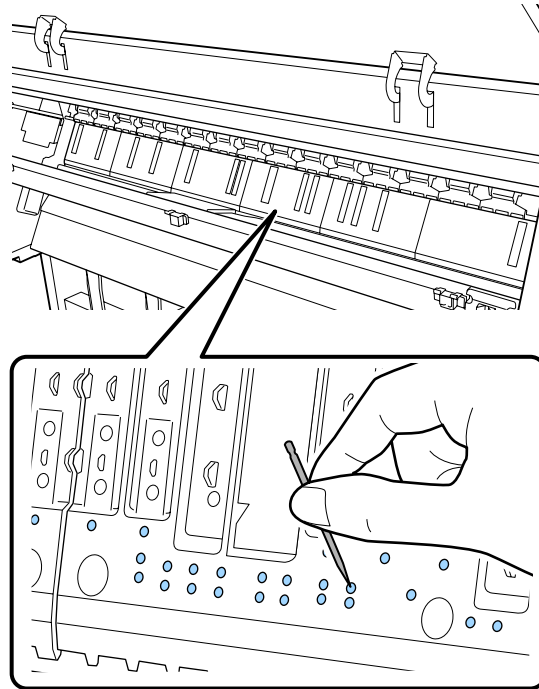

6. Use cotton swabs to remove any paper particles or dust around the outer edges of the borderless pads as shown.

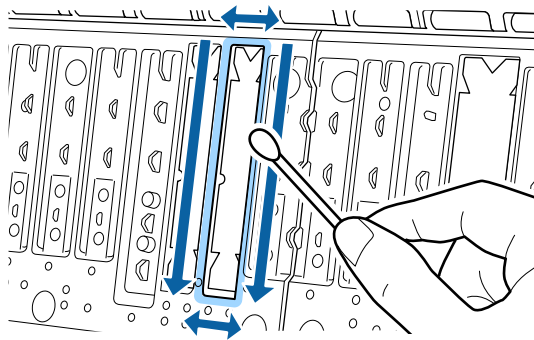

7. Close the front cover, plug in the power cord, and turn the product back on.

Parent topic: [Maintenance and Transportation](#)

Wiping the Print Head

If the print head is clogged and automatic cleaning does not fix the issue, you can clean the print head and the area around the caps using the optional cleaning sticks (part number C13S090013).

Caution: Before beginning the cleaning process, note the following:

- Do not touch any circuit boards or any parts inside the printer besides those which need to be cleaned.
- Always use new cleaning sticks, or dirt may be transferred into the printer.
- Do not touch the tip of the cleaning stick. This may reduce the cleaning effect.
- Touch a metal object before cleaning to discharge any static electricity.
- Do not use an organic solvent such as alcohol to wipe the caps, as it may damage the print head.
- Do not move the print head by hand. Doing so could damage the printer.
- If paper is loaded in the printer, remove it.

1. On the LCD screen, select **Menu > Maintenance > Cleaning the Maintenance Parts > Wiping the Print Head**. The print head moves to the cleaning position.

2. Remove the rear maintenance cover by lifting the tab and pulling the cover up and out.

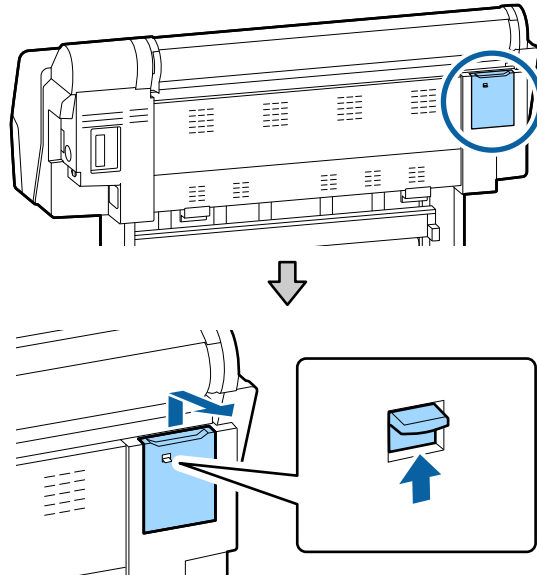

3. Use a cleaning stick to wipe the print head as shown to remove any ink, lint, or dirt.

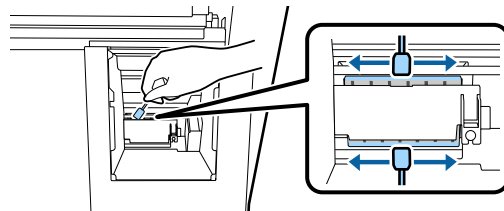

Caution: Do not touch the parts indicated below. Doing so may cause the printer to malfunction or print quality to decline.



4. Replace the rear maintenance cover and make sure it is secured.
5. Select **OK** to return the print head to its home position.

Parent topic: [Maintenance and Transportation](#)

Related tasks

[Removing Roll Paper](#)

Cleaning the Print Head Cap Area

If the print head is clogged and automatic cleaning does not fix the issue, you can clean the print head and the area around the caps using the optional cleaning sticks (part number C13S090013)

Caution: Before beginning the cleaning process, note the following:

- Do not touch any circuit boards or any parts inside the printer besides those which need to be cleaned.
- Always use new cleaning sticks, or dirt may be transferred into the printer.
- Do not touch the tip of the cleaning stick. This may reduce the cleaning effect.

- Touch a metal object before cleaning to discharge any static electricity.
- Do not use an organic solvent such as alcohol to wipe the caps, as it may damage the print head.
- Do not move the print head by hand. Doing so could damage the printer.
- If paper is loaded in the printer, remove it.

1. On the LCD screen, select **Menu > Maintenance > Cleaning the Maintenance Parts > Wiping around the Cap.**

The print head moves to the cleaning position.

2. Open the ink cartridge cover on the right.

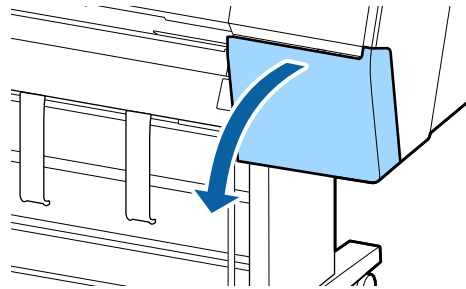

3. Pull the tab down and remove the front maintenance cover by sliding it to the right.

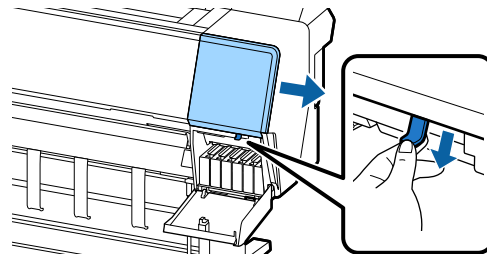

4. Open the front cover.

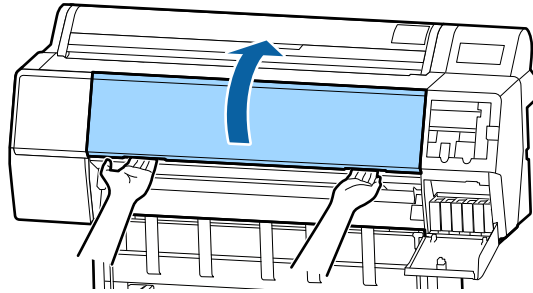

5. Use a new cleaning stick to clean the drying prevention caps area as shown. Hold the cleaning stick in a vertical position and wipe the inner areas of the drying prevention caps as shown.

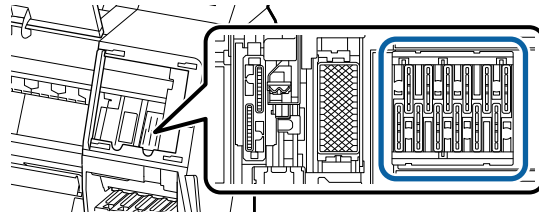

6. Hold the cleaning stick in a vertical position and wipe the outer areas of the drying prevention caps as shown.

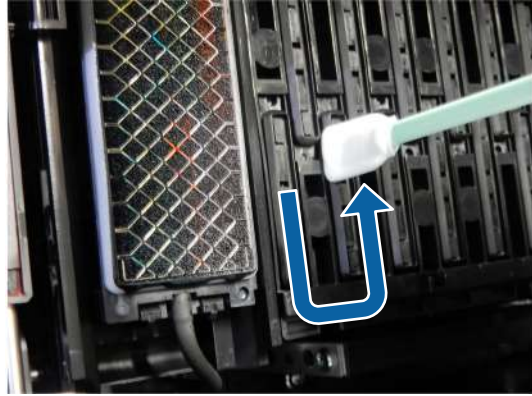

7. Hold the cleaning stick in a horizontal position and wipe the edges of the drying prevention caps as shown.

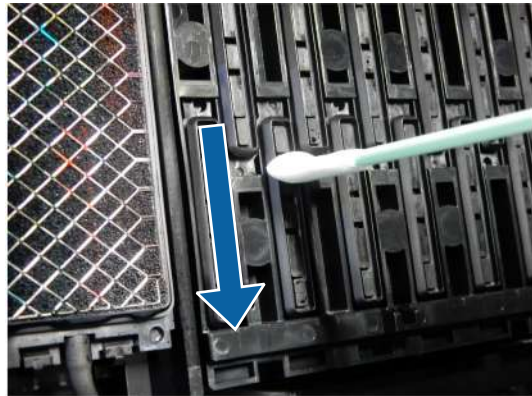

8. Hold the cleaning stick in a vertical position and wipe the guides as shown.

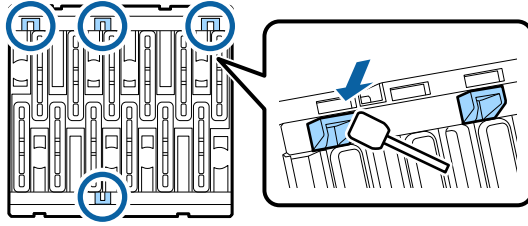

9. If there is any lint or dust in the drying prevention caps, remove it with a cleaning stick or a pair of tweezers.



10. Use a new cleaning stick to wipe the outer edges of the front wiper as shown.

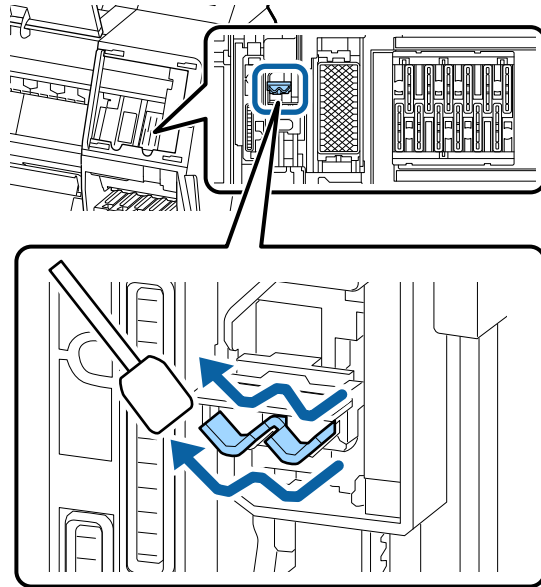

11. Wipe the outer edges of the back wiper as shown.

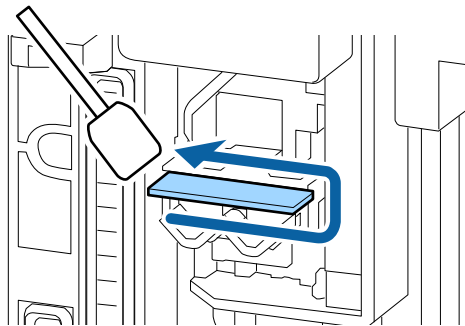

12. Wipe the front edge of the back wiper as shown.

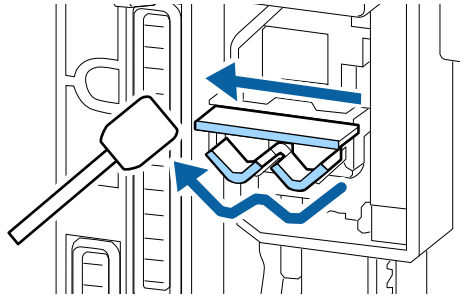

13. Hold a new cleaning stick in a vertical position and wipe the outer areas of the suction caps as shown.

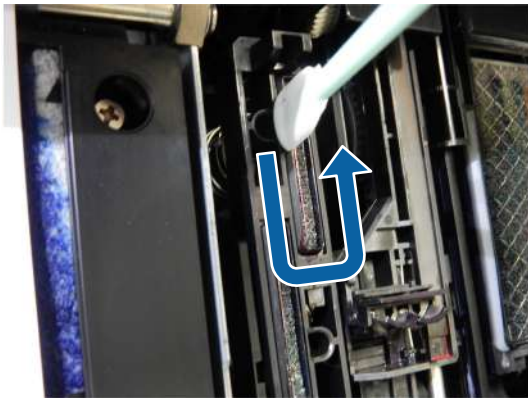

14. Hold the cleaning stick in a horizontal position and wipe the edges of the suction caps as shown.

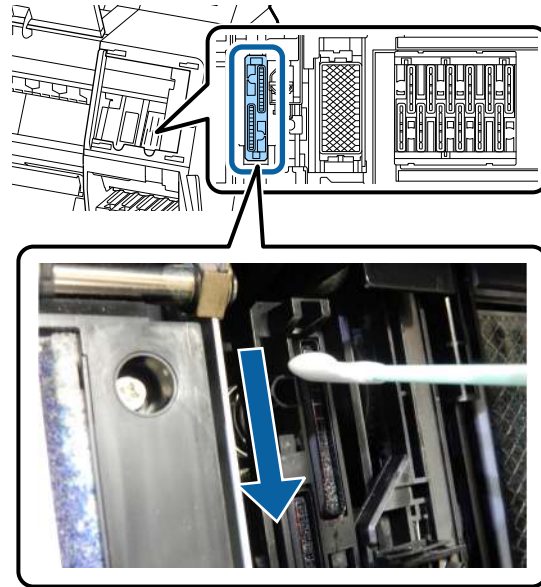

15. Hold the cleaning stick in a vertical position and wipe the guides shown here.

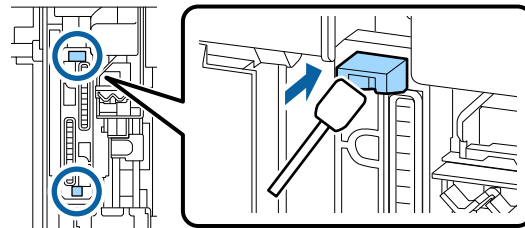

16. If there is any lint or dust in the suction caps, remove it with a cleaning stick or a pair of tweezers.



17. Close the front cover.
18. Attach the front maintenance cover and close the ink cartridge cover.
19. Select **OK** to return the print head to its home position.

Parent topic: [Maintenance and Transportation](#)

Related tasks

[Removing Roll Paper](#)

Moving or Transporting Your Product

If you need to move or transport your product, prepare it as described here. Moving the printer assumes that you are moving it to another location on the same floor, without using elevators, ramps, or stairs. If you are moving the printer between floors or to another building, follow the instructions for transporting your product.

Warning: Use only the indicated locations to lift the printer. Otherwise, the printer may be damaged or you may be injured.

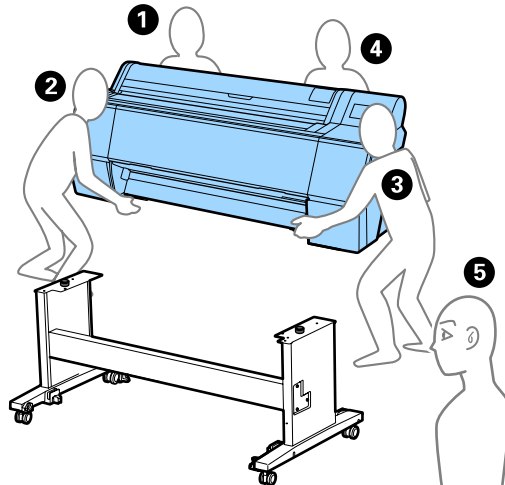
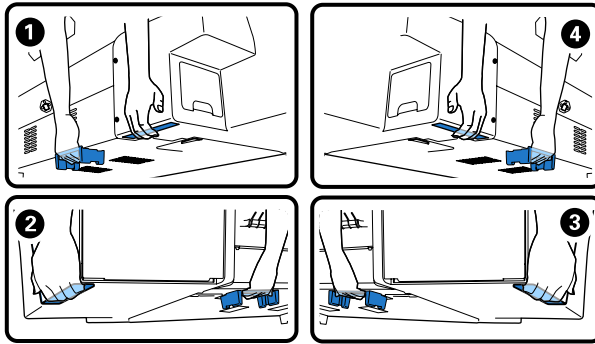

Caution: During transportation and storage, follow these guidelines:

- If you need to move or transport your product when the temperature is 14°F (–10°C) or lower, you must first discharge the ink to keep the print head in optimum condition.
- Use the casters to move the printer indoors a short distance over a level floor. Do not use the casters for transport.
- Avoid tilting the product more than 10° forward or backward while moving it.
- Leave the ink cartridges installed. Removing the cartridges can dry out the print head and may prevent the product from printing, or ink may leak.
- If you are repackaging the printer for transport, use four or more people to lift it.

- When lifting the printer, do not place your hands in the following locations:

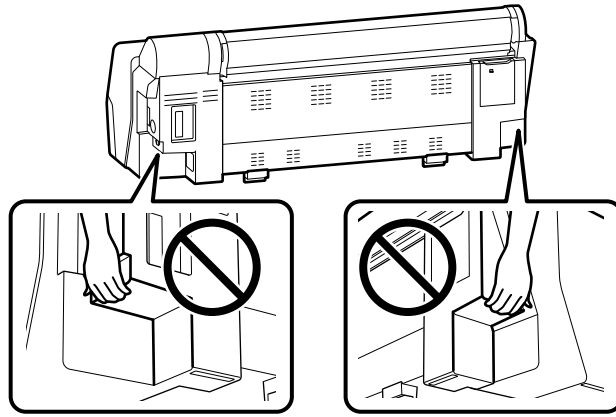

Note: Before storing your product for a long period, replace low, expended, or expired ink to help prevent the print head from drying out. Store your product in a cool, dry place.

1. If you are packaging the printer for transport, remove any loaded paper.
2. Turn off the printer and remove all connected cables.
3. Do one of the following:
 - If you are moving the printer to another location on the same floor, remove the optional SpectroProofer and Auto Take-up Reel, if installed. Unlock the casters and move the printer to the new location.
 - If you are packaging the printer for transport, remove all optional accessories and continue with the next step.

Note: To uninstall optional accessories, see the documentation that came with them.

4. Package the printer in the original box and shipping materials. Be sure to lift the printer according to the guidelines listed here.
5. Secure the print head and roll paper spindle using the packing material you retained during printer setup.

Note: See the *Setup and Maintenance Guide* for details on the location of the packing material.

6. After transporting the printer, follow the instructions in the *Setup and Maintenance Guide* to set up the printer.
7. Run a print head nozzle check and clean the print head, if necessary.

[Discharging Ink](#)

Parent topic: [Maintenance and Transportation](#)

Related tasks

[Removing Roll Paper](#)

[Checking the Nozzles Using the Product Control Panel](#)

[Checking the Nozzles Using a Computer Utility](#)

Discharging Ink

If you need to move or transport your product when the temperature is 14°F (–10°C) or lower, you must first discharge the ink to keep the print head in optimum condition.

Note: The maintenance box needs enough capacity to discharge the ink. If the remaining capacity is low, replace the maintenance box first.

1. Turn on the printer.
2. Remove all the paper from the printer.
3. Press the  home button, if necessary.
4. Select **Menu > Maintenance > Keeping/Transporting Preparation**.
5. Do one of the following:
 - If you are planning to store the printer for an extended time, select **Keeping Preparation** and select **Start**.
 - If you are planning to package the printer for transport, select **Personal Transport Preparation** and select **Start**.

The ink begins to discharge. The printer turns off automatically when the discharge process is complete.

Caution: Do not open any covers or turn off the printer while ink is discharging.

Parent topic: [Moving or Transporting Your Product](#)

Related tasks

[Removing Roll Paper](#)



Solving Problems

Check these sections for solutions to problems you may have using your product.

- [Checking for Software Updates](#)
- [Product Status Messages](#)
- [Resetting Control Panel Defaults](#)
- [Solving Printer Problems](#)
- [Solving Printing Problems](#)
- [Solving Paper Problems](#)
- [Solving Print Quality Problems](#)
- [Uninstalling Product Software - Windows](#)
- [Uninstalling Product Software - Mac](#)
- [Where to Get Help](#)

Checking for Software Updates

Periodically, it's a good idea to check Epson's support website for free updates to your product software. Visit epson.com/support (U.S.), epson.ca/support (Canada), or epson.com.jm/support (Caribbean) and select your product.

- **Windows:** Your printer software automatically checks for updates. You can also manually update the software by:
 - Accessing the Windows Desktop and right-clicking the  icon for your product in the right side of the Windows taskbar, or clicking the up arrow and right-clicking . Select **Software Update**.
 - Clicking on the **Utility** tab in the printer settings window and selecting **Driver Update**You can also update the software by selecting **EPSON Software Updater** in the **EPSON** or **EPSON Software** program group, accessible by the **Start** button, or on the **Start** or **Apps** screens, depending on your version of Windows.
- **OS X:** You can manually update the software by opening the **Applications > Epson Software** folder and selecting **EPSON Software Updater**.
- **macOS 10.12.x, 10.13.x, or 10.14.x:** You can manually update the software by opening the **App Store**, selecting **Updates**, searching for a software update option for Epson Software, and selecting **Update**.

Parent topic: [Solving Problems](#)

Product Status Messages

You can often diagnose problems with your product by checking the messages on the LCD screen.

LCD screen message	Condition/solution
<p>Paper setting in the printer driver is different from paper information registered in the printer.</p> <p>Change paper setting from the application or the driver.</p> <p>For details, see your documentation.</p>	<p>To change paper information that was registered using Epson Media Installer, load the paper and then use the control panel.</p> <p>You can also use Epson Media Installer to change paper information for paper that has not been loaded.</p> <p>Depending on the version of Epson Media Installer you are using, you may not be able to change the paper information.</p>
<p>The combination of the IP address and the subnet mask is invalid.</p> <p>See your documentation for more details.</p>	<p>Enter the correct values for the IP address and the default gateway. Check with your network administrator if you do not know the correct values.</p>
<p>SpectroProofer error NN</p>	<p>See the SpectroProofer documentation for details on the displayed error code.</p>
<p>A printer part needs to be replaced</p> <p>Contact Epson Support. For details, see your documentation.</p> <p>(maintenance request code)</p>	<p>A part used in the printer is nearing the end of its service life. Contact Epson for support and provide them with the displayed maintenance request code. The error persists until you replace the requested part. If you continue to use the printer, a printer error will occur.</p>

LCD screen message	Condition/solution
Printer error (service code) Turn the power off and on again. If the problem persists, contact Epson support. XXXXXXXX	An error message occurs when: <ul style="list-style-type: none"> • The power cable is not connected securely • An error occurs that cannot be cleared When a printer error has occurred, the printer automatically stops printing. Turn off the printer, disconnect the power cable from both the outlet and the printer, and reconnect them. Turn the printer on and off several times. If the same error message is displayed on the LCD screen, contact Epson for support and provide them with the displayed service code.

Parent topic: [Solving Problems](#)

Resetting Control Panel Defaults

If you have a problem with settings on the product control panel, you can reset them to their factory defaults. You can choose which settings to reset or reset them all.

Note: This setting can be locked by an administrator. If you cannot access or change this setting, contact your administrator for assistance.

1. Press the  home button, if necessary.
2. Select **Menu > General Settings > System Administration > Restore Default Settings**.
3. Select one of these options:
 - **Network Settings:** Resets all network settings.
 - **Clear All Data and Settings:** Resets all control panel settings except date and time, length unit, and language settings.
 You see a confirmation screen.
4. Select **Yes** to reset the selected settings. (Select **No** if you want to cancel the operation.)

Parent topic: [Solving Problems](#)

Solving Printer Problems

Check these sections if you have problems operating your product.

[Printer Does Not Turn On](#)
[LCD Screen Shuts Off](#)

[Forgot the Administrator Password](#)

Parent topic: [Solving Problems](#)

Printer Does Not Turn On

If the printer does not turn on, try these solutions:

- Make sure the power cable is securely connected.
- Make sure the power outlet works by connecting the power cable for another electronic device.

Parent topic: [Solving Printer Problems](#)

LCD Screen Shuts Off

If the LCD screen shuts off intermittently, the printer may be in sleep mode. Try these solutions:

- Press the touchscreen or any of the buttons on the control panel to exit sleep mode.
- You can adjust the delay time before the product enters sleep mode in the Basic Settings menu.

Parent topic: [Solving Printer Problems](#)

Forgot the Administrator Password

If you forgot the administrator password you created during network setup, contact Epson for support.

Parent topic: [Solving Printer Problems](#)

Solving Printing Problems

Check these sections if you have problems printing with your product.

[Nothing Prints](#)

[Cannot Print Over a Network](#)

[Print Head Moves But Nothing Prints](#)

Parent topic: [Solving Problems](#)

Nothing Prints

If you have sent a print job and nothing prints, try these solutions:

- Make sure your printer is turned on.
- Make sure there are no error messages on the product's LCD screen.

- Make sure any interface cables are connected securely at both ends. If you have a spare cable, try connecting with the spare cable.
- Check the model and specifications of the interface cable to see if the cable is appropriate for your computer and printer.
- If you connected your printer to a USB hub, make sure it is a first-tier hub. If it still does not print, connect your printer directly to your computer instead of the hub.
- Make sure the USB hub is recognized correctly on the computer. Disconnect all USB hubs from the computer and connect the printer directly to the computer's USB port.
- If you have an optional print server connected to the printer, make sure you are not saving the print job to the hard drive.
- Make sure the USB cable length does not exceed 10 feet (3 m).

Parent topic: [Solving Printing Problems](#)

Cannot Print Over a Network

If you cannot print over a network, try these solutions:

- Make sure that your printer is turned on.
- If you are using TCP/IP, make sure the printer's IP address is set correctly for your network. If your network does not assign IP addresses using DHCP, set the IP address manually.
- Check your wired LAN router or access point to see if the LED for the port to which your printer is connected is on or flashing. If the link LED is off, try the following:
 - Make sure the Ethernet cable is securely connected to your printer and to your router, access point, switch, or hub.
 - Try connecting your printer to a different port or a different router, access point, switch, or hub.
 - Try connecting with a different Ethernet cable.
 - Try printing to your printer from another computer on the network.
 - Try connecting your printer directly to the computer using a USB cable.

Parent topic: [Solving Printing Problems](#)

Related tasks

[Selecting Network Settings from the Control Panel](#)

[Printing a Network Connection Report](#)

[Printing a Network Status Sheet](#)

Print Head Moves But Nothing Prints

If the print head is moving and nothing prints, try these solutions:

- Print a nozzle check pattern. If the pattern does not print correctly, clean the print head again. (If the printer has not been used for a long time the nozzles may be clogged.)
- If you see a message about motor self adjustment on the product's LCD screen, the printer is adjusting its internal motor. Wait a few moments for the message to disappear and do not turn off the printer.

Parent topic: [Solving Printing Problems](#)

Related concepts

[Print Head Nozzle Check](#)

Solving Paper Problems

Check these sections if you have problems using paper with your product.

[Paper Feeding Problems](#)

[Roll Paper Jam Problems](#)

[Cut Sheet Paper Jam Problems](#)

[Paper Does Not Collect in the Basket or is Creased](#)

Parent topic: [Solving Problems](#)

Paper Feeding Problems

If you have problems feeding paper, try these solutions:

- Make sure paper is loaded in the correct orientation. Load cut sheets vertically (short edge first).
- For best results, follow these guidelines:
 - Use new, smooth, high-quality paper that is not damp, curled, creased, old, too thin, or too thick.
 - Follow any special loading instructions that came with the paper.
- If roll paper does not feed, cut the end straight across and uncurl it by rolling it backward, if necessary. Then reload the paper.
- Make sure there are no paper particles on the roll paper adapters. Clean the adapters if necessary.
- If wrinkles appear on roll paper, adjust the **Back Tension** setting.
- If you cannot insert paper easily into the paper feed slot, make sure the paper is perfectly flat and not curled.

- Do not load more than one piece of cut sheet paper.
- Make sure your paper meets the specifications for your product.
- Make sure you selected the **Media Type** setting in the printer driver that matches the paper you loaded in the product.
- If thick media does not feed, make sure you are loading it straight into the product, not at an angle.
- If poster board does not feed, make sure you are loading it straight into the product, not at an angle.
- If paper does not eject correctly, decrease the **Paper Suction** setting for the loaded paper type.
- Make sure that paper is not jammed inside the product.
- Make sure you are using the product at the proper room temperature.

Parent topic: [Solving Paper Problems](#)

Related references

[Environmental Specifications](#)

[Roll Paper Jam Problems](#)

[Cut Sheet Paper Jam Problems](#)

[Paper Specifications](#)

Related tasks

[Loading Roll Paper](#)

[Loading Cut Sheets](#)

[Loading Thick or Large Cut Sheets \(Poster Board\)](#)

Roll Paper Jam Problems

If roll paper has jammed in the printer, follow the steps here to clear the jam.

1. Open the roll paper cover.
2. Cut the paper above the paper feed slot.

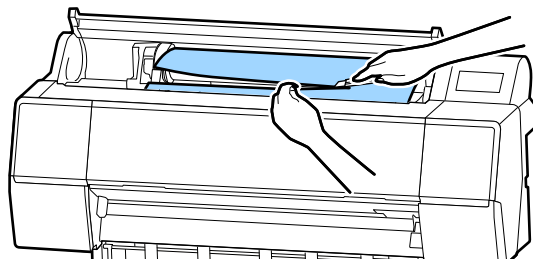

3. Rewind the roll paper and open the front cover.

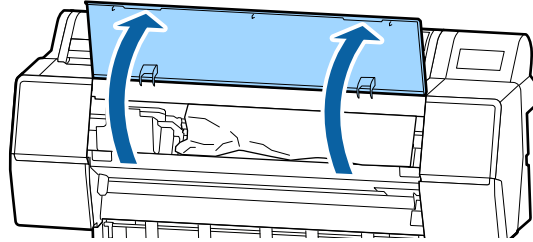

4. Carefully slide the print head away from the paper jam as shown.

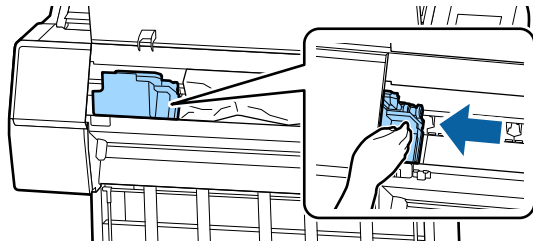

Caution: Do not touch the print head unless you are removing a paper jam. Touching the print head may cause a static shock and damage the printer.

5. Remove the jammed paper.

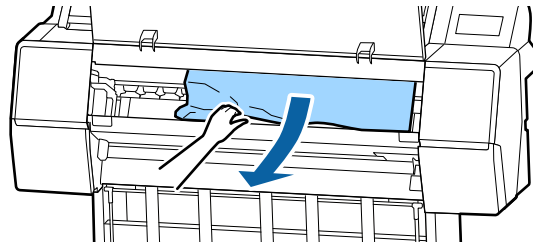

Caution: Do not touch the rollers, ink absorbing areas, or ink tubes shown here or you may damage the printer.

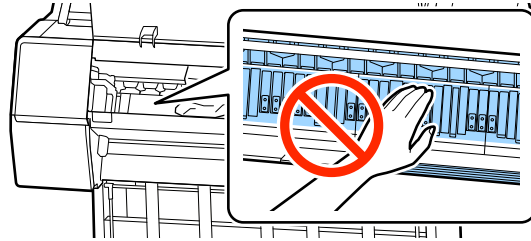

6. Close the front cover.
7. Turn the printer off and back on again.
8. Cut the edge of the roll paper straight horizontally, then reload the roll paper.

Note: Make sure to cut off any jagged or folded sections of paper.

Parent topic: [Solving Paper Problems](#)

Cut Sheet Paper Jam Problems

If cut sheet paper has jammed in the printer, follow the steps here to clear the jam.

1. Open the front cover.

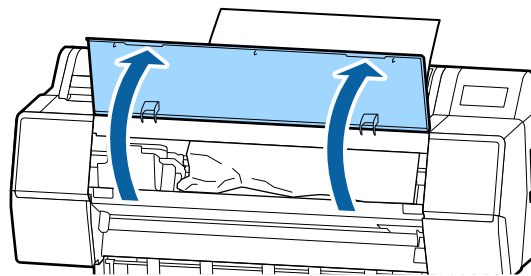

Caution: Do not touch the ribbon cable inside the printer.

2. Carefully slide the print head away from the paper jam as shown. .

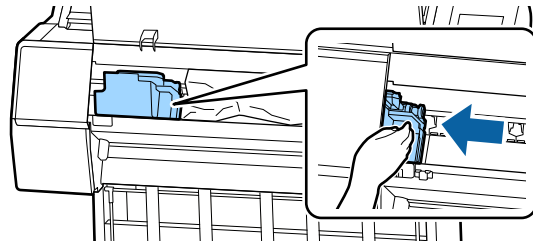

Caution: Do not touch the print head unless you are removing a paper jam. Touching the print head may cause a static shock and damage the printer.

3. Remove the jammed paper.

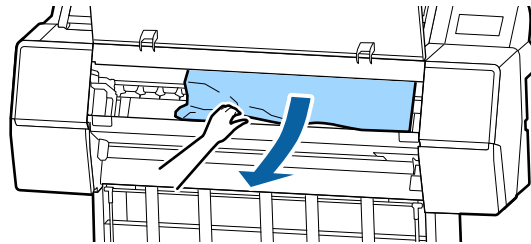

Caution: Do not touch the rollers, ink absorbing areas, or ink tubes shown here or you may damage the printer.

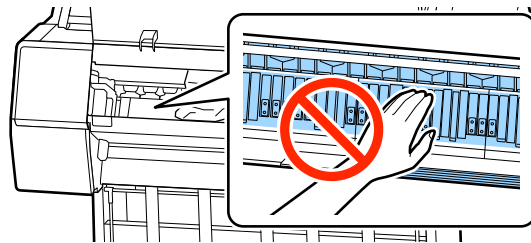

4. Close the front cover.

5. Turn the printer off and back on again.
6. Reload the paper, making sure it is not skewed.

Parent topic: [Solving Paper Problems](#)

Paper Does Not Collect in the Basket or is Creased

If paper does not collect correctly in the paper basket, try these solutions:

- If paper does not collect in the basket, gently press on the paper basket as paper is ejected from the printer. This prevents the paper from catching on the basket.
- If the paper folds after cutting, set the **Auto Cut** setting to **Off**. Cut the paper manually while supporting the print.
- If the paper creases and does not collect in the basket, close the basket and resume printing. Before the paper reaches floor, hold the paper with both hands and continue to support it until printing is complete. Do not load more than one piece of cut sheet paper at a time.

Parent topic: [Solving Paper Problems](#)

Solving Print Quality Problems

Check these sections if you have problems with print quality.

[Nozzle Check Pattern Prints Incorrectly](#)

[Overall Print Quality is Poor](#)

[Lines Are Misaligned](#)

[Prints are Scuffed or Smeared](#)

[Prints are Wrinkled](#)

[Margins Appear in Borderless Prints](#)

Parent topic: [Solving Problems](#)

Nozzle Check Pattern Prints Incorrectly

If the nozzle check pattern does not print correctly, try these solutions:

- Clean the print head and print the check pattern again.
- If the printer has not been used for a long time, nozzles may be dried and clogged. Turn the printer on at least once every few weeks and print a nozzle check pattern to prevent the nozzles from clogging.

Parent topic: [Solving Print Quality Problems](#)

Related concepts

[Print Head Nozzle Check](#)

[Print Head Cleaning](#)

[Print Head Alignment](#)

Related tasks

[Running a Power Cleaning Using the Product Control Panel](#)

Overall Print Quality is Poor

If you notice that your print quality is uneven, too light, too dark, or there are lines in the print (banding), try these solutions:

- Run a nozzle check to see if any of the print head nozzles are clogged. Then clean the print head, if necessary.
- Align the print head.
- Make sure your ink cartridges have not expired. For best results, use ink cartridges before the expiration date printed on the package (within one year of installation in the printer). Replace expired cartridges with new ones.
- Shake the cartridges before installing them in the printer. To maintain optimum print quality, remove and shake the installed cartridges every six months or if the printer has not been used in the last three months.
- Make sure you selected the correct **Media Type** setting in the printer driver that matches the paper loaded in the printer.
- Compare the print result with the image on your computer screen. Since monitors and printers produce colors differently, printed colors and screen colors do not always look the same.
- Make sure that the printer cover is closed during printing.
- Check the ink levels on the LCD screen. Replace any cartridges that are low on ink.
- Enable color management in the software application or in the printer driver.
- If you are using non-Epson media, make sure you create a custom paper configuration for the media.
- Check the quality setting that you selected in the printer driver. Using a faster printing method may decrease the overall print quality.
- If colors are uneven near the leading edge of the print, add a larger margin. In the print driver, you can also set **Quality Options > Optimize Edge Quality** to **Add Top Margin** or **Optimize Media Edge Quality**.

Parent topic: [Solving Print Quality Problems](#)

Related concepts

[Print Head Nozzle Check](#)

[Print Head Alignment](#)

Related tasks

[Removing and Installing Ink Cartridges](#)

[Selecting Basic Print Settings - Windows](#)

[Selecting Basic Print Settings - Mac](#)

[Creating Custom Paper Settings](#)

Lines Are Misaligned

You may see vertical lines in the (bi-directional) print output. If this occurs, align the print head.

Parent topic: [Solving Print Quality Problems](#)

Related concepts

[Print Head Alignment](#)

Prints are Scuffed or Smear

If your prints are scuffed or smeared, try these solutions:

- Make sure your paper meets the specifications for your product.
- Do not use paper with folds or creases and always use new media.
- If you are using cut sheet paper, check that changes in humidity and temperature have not made the paper wavy or curled up on the edges. Flatten the paper before loading it or use new paper.
- If the surface of the paper is scuffed, select a wider **Platen Gap** setting. If results do not improve, set **Custom Paper Setting > Paper Eject Roller to Use**.

Caution: The **Paper Eject Roller** setting may damage glossy paper.

- If the bottom edge is scuffed, try widening the bottom margin. Set **Top Margin** to **45 mm** and **Bottom Margin** to **15 mm**
- If ink is smeared on your prints, clean the rollers. Load blank paper and select  > **Forward** to feed it through the printer.
- If you are using non-Epson media, make sure you create a custom paper configuration for the media.
- Make sure the **Paper Size Check** setting is set to **On**, or the printer may print outside the edges of the loaded paper and smear ink on the back of the print.

- Depending on the print density and type of paper you are using, the ink may take a while to dry. Do not stack the prints until the ink is completely dry.
- If the trailing edge is scuffed while printing, create your data with a wider margin. If the situation does not improve, select **Paper Edge Quality** from the printer driver.
- If you are printing multiple pages and **Auto Cut** is set to **Never Cut**, the area between pages may be scuffed. Set **Margin Between Pages** to **65mm** from Custom Paper Setting.

Parent topic: [Solving Print Quality Problems](#)

Related references

[Paper Specifications](#)

Related tasks

[Cleaning the Roll Paper Feeder](#)

[Creating Custom Paper Settings](#)

Related topics

[Cutting Roll Paper](#)

Prints are Wrinkled

If you see wrinkles on your prints, try the following to solve the problem:

- Dry the paper after printing.
- Roll out the paper and stretch it.
- Lower the color density in the **Paper Configuration** dialog in the printer driver.
- Lower the resolution in the **Print Quality** setting in the printer driver.

Parent topic: [Solving Print Quality Problems](#)

Margins Appear in Borderless Prints

If borderless prints still have margins, try these solutions:

- Check the print settings selected in your print application you are using, as well as the printer driver.
- Make sure that the paper settings on the LCD screen match the paper you loaded.
- Make sure borderless enlargement is not set to **Min** in the printer driver.
- Paper that is stored incorrectly may expand or contract. Make sure you have stored the paper according to the manufacturer's specifications.
- Check that the paper you are using supports borderless printing.

- If you are using roll paper, change the **Adjust Cut Position** setting. This may reduce the margins at the top and bottom of the print.

Parent topic: [Solving Print Quality Problems](#)

Related references

[Borderless Paper Type Compatibility](#)

[Paper Specifications](#)

Related tasks

[Loading Roll Paper](#)

[Loading Cut Sheets](#)

[Loading Thick or Large Cut Sheets \(Poster Board\)](#)

[Selecting Basic Print Settings - Windows](#)

[Selecting Basic Print Settings - Mac](#)

Uninstalling Product Software - Windows

You can uninstall and then re-install your printer software to solve certain problems.

1. Turn off the product.
2. Disconnect any interface cables.
3. Do one of the following:
 - **Windows 10:** Right-click  and select **Control Panel > Programs > Programs and Features**. Select the uninstall option for your Epson product, then select **Uninstall/Change**.

Note: If you see a **User Account Control** window, click **Yes** or **Continue**.

Select your product again, if necessary, then select **OK**, and click **Yes** to confirm the uninstallation.

- **Windows 8.x:** Navigate to the **Apps** screen and select **Control Panel > Programs > Programs and Features**. Select the uninstall option for your Epson product, then select **Uninstall/Change**.

Note: If you see a **User Account Control** window, click **Yes** or **Continue**.

Select your product again, if necessary, then select **OK**, and click **Yes** to confirm the uninstallation.

- **Windows (other versions):** Click  or **Start**, and select **All Programs** or **Programs**. Select **Epson**, select your product, then click **EPSON Printer Software Uninstall**.

Note: If you see a **User Account Control** window, click **Yes** or **Continue**.

In the next window, select your product and click **OK**. Then follow any on-screen instructions.

4. Restart your computer, then re-install your software.

Note: If re-installing your product software does not solve a problem, contact Epson support.

Parent topic: [Solving Problems](#)

Uninstalling Product Software - Mac

In most cases, you do not need to uninstall your product software before re-installing it. However, you can download the Uninstaller utility from the Epson support website to uninstall your product software as described here.

Note: If re-installing your product software does not solve a problem, contact Epson support.

1. To download the Uninstaller utility, visit epson.com/support (U.S.), epson.ca/support (Canada), or epson.com.jm/support (Caribbean) and select your product.
2. Click **Downloads**.
3. Select your operating system, click **Utilities**, locate the Uninstaller utility, and click **Download**. (If you do not see an Uninstaller utility, search for "Uninstaller" using the site search field.)
4. Run the file you downloaded.
5. Double-click the **Uninstaller** icon.
6. In the Epson Uninstaller screen, select the checkbox for each software program you want to uninstall.
7. Click **Uninstall**.
8. Follow the on-screen instructions to uninstall the software.
9. Reinstall your product software.

Note: If you uninstall the printer driver and your product name remains in the **Print & Fax**, **Print & Scan**, or **Printers & Scanners** window, select your product name and click the – (remove) icon to remove it.

Parent topic: [Solving Problems](#)

Where to Get Help

Epson provides technical support and information on the installation, configuration, and operation of professional printing products through the Epson Preferred Limited Warranty Plan. Dial (888) 377-6611, 6 AM to 6 PM, Pacific Time, Monday through Friday. Days and hours of support are subject to change without notice.

Note: If you experience difficulty with the toll-free number, call (562) 276-1305 (U.S.).

Before you call, make sure you have your printer serial number and proof of purchase.

Visit epson.com/support (U.S.) or epson.ca/support (Canada) and select your product for solutions to common problems. You can download drivers, firmware, and documentation, get FAQs and troubleshooting advice, or e-mail Epson with your questions.

Note: For help using any other software on your system, see the documentation for that software for technical support information.

Purchase Supplies and Accessories

You can purchase genuine Epson ink, paper, and accessories from an Epson authorized reseller. To find the nearest reseller, visit proimaging.epson.com (U.S.) or proimaging.epson.ca (Canada), select your product series and product, and click the **Where to Buy** button. Or call 800-GO-EPSON (800-463-7766) in the U.S. or 800-807-7766 in Canada.

Parent topic: [Solving Problems](#)

Technical Specifications

These sections list the technical specifications for your product.

Note: Epson offers a recycling program for end of life Epson products. Please go to [this site](#) (U.S) or [this site](#) (Canada) for information on how to return your Epson products for proper disposal.

[Windows System Requirements](#)

[Mac System Requirements](#)

[Paper Specifications](#)

[Printable Area Specifications](#)

[Ink Cartridge Specifications](#)

[Dimension Specifications](#)

[Electrical Specifications](#)

[Environmental Specifications](#)

[Interface Specifications](#)

[Safety and Approvals Specifications](#)

Windows System Requirements

To use your product and its software, your computer should meet these requirements.

Microsoft Windows OS version (32- and 64-bit compatible)	Windows 10, Windows 8.x, Windows 7, Windows Vista, Windows Server 2016, Windows Server 2012 R2, Windows Server 2012, Windows Server 2008 R2, Windows Server 2008, Windows Server 2003 R2, Windows Server 2003 SP2 or later
CPU	Core 2 Duo 3.05 GHz or better
Memory	1GB or more
Hard disk space available	32GB or more
Display resolution	WXGA (1280 × 800) or higher

Note: For the latest product software available for your operating system, visit the Epson support site at epson.com/support (U.S.), epson.ca/support (Canada), or epson.com.jm/support (Caribbean), select your product, and select **Downloads**.

Parent topic: [Technical Specifications](#)

Mac System Requirements

To use your product and its software, your Mac should meet these requirements.

OS X version	Mac OS X 10.7.5 through macOS 10.15.x
CPU	Core 2 Duo 3.05 GHz or better
Memory	1GB or more
Hard disk space available	32GB or more
Display resolution	WXGA+ (1440 × 900) or higher

Note: Epson Media Installer requires OS X 10.9.x or later to be installed.

Note: For the latest product software available for your operating system, visit the Epson support site at epson.com/support (U.S.), epson.ca/support (Canada), or epson.com.jm/support (Caribbean), select your product, and select **Downloads**.

Parent topic: [Technical Specifications](#)

Paper Specifications

Note: Since the quality of any particular brand or type of paper may be changed by the manufacturer at any time, Epson cannot guarantee the quality of any non-Epson brand or type of paper. Always test a sample of paper stock before purchasing large quantities or printing large jobs.

Cut sheet paper

Size

A4 (8.3 × 11.7 inches [210 × 297 mm])
A3 (11.7 × 16.5 inches [297 × 420 mm])
13 × 19 inches (330 × 483 mm)
A2 (16.5 × 23.4 inches [420 × 594 mm])
A1 (23.4 × 33.1 inches [594 × 841 mm])
A0 (33.1 × 44 inches [841 × 1189 mm])*
Super A0 (36 × 50.9 inches [914 × 1292 mm])*
Letter (8.5 × 11 inches [216 × 279 mm])
Legal (8.5 × 14 inches [216 × 356 mm])
8 × 10 inches (203 × 254 mm)
9 × 12 inches (229 × 305 mm)
10 × 12 inches (254 × 305 mm)
11 × 14 inches (279 × 356 mm)
11 × 17 inches (279 × 432 mm)
12 × 12 inches (305 × 305 mm)
12 × 18 inches (305 × 457 mm)
16 × 20 inches (279 × 432 mm)
17 × 22 inches (432 × 559 mm)
18 × 24 inches (457 × 610 mm)
22 × 34 inches (559 × 864 mm)
24 × 36 inches (610 × 910 mm)
34 × 44 inches (864 × 1120 mm)*
36 × 48 inches (910 × 1219 mm)*

*SureColor P9500 Series only

SureColor P7500 Series:

Non-standard sizes between 7.2 inches (182 mm) and 24 inches (610 mm) wide, and between 11.7 inches (297 mm) and 36 inches

(914 mm) long

SureColor P9500 Series:

Non-standard sizes between 7.2 inches (182 mm) and 44 inches (1118 mm) wide, and between 11.7 inches (297 mm) and 62.2 inches (1580 mm) long

Thickness

Plain paper: 0.003 to 0.06 inches (0.08 to 1.5 mm)

Thick paper: 0.02 to 0.06 inches (0.5 to 1.5 mm)

Roll paper

Core size

2 inches (51 mm) and 3 inches (76 mm)

Outer diameter

2-inch core: up to 4.1 inches (103 mm)

3-inch core: up to 5.9 inches (150 mm)

Width

SureColor P7500 Series:

10 inches (254 mm) to 24 inches (610 mm)

SureColor P9500 Series:

10 inches (254 mm) to 44 inches (1118 mm)

Thickness

Plain paper: 0.003 to 0.02 inches (0.08 to 0.5 mm)

Note: Maximum thickness is reduced to 0.02 inches (0.45 mm) when using the optional SpectroProofer.

Parent topic: [Technical Specifications](#)

Printable Area Specifications

Note: When printing borderless, quality may decline in the expanded printable area.

Cut sheet paper

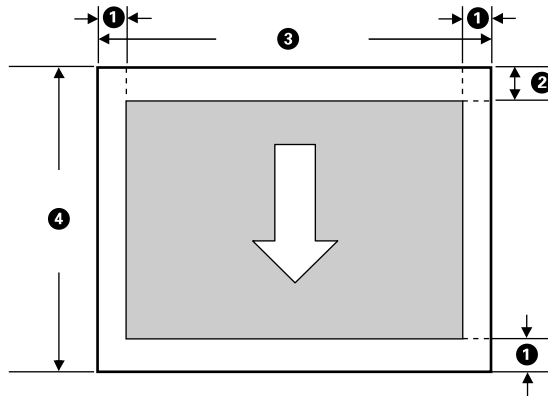

Note: When printing borderless, the left and right margins are 0.

- 1 Left/right/top margin: 0.12 inch (3 mm) minimum
- 2 Bottom margin: 0.55 inch (14 mm) minimum
Epson Enhanced Matte Posterboard: 0.61 inch (15.5 mm) minimum
- 3 **SureColor P7500 Series:**
Printable width: 10 inches (254 mm) to 24 inches (610 mm)
SureColor P9500 Series:
Printable width: 10 inches (254 mm) to 44 inches (1118 mm)
- 4 **SureColor P7500 Series**
Printable length: 11 inches (279 mm) to 36 inches (914 mm)
SureColor P9500 Series:
Printable length: 11 inches (279 mm) to 62.2 inches (1580 mm)

Roll paper

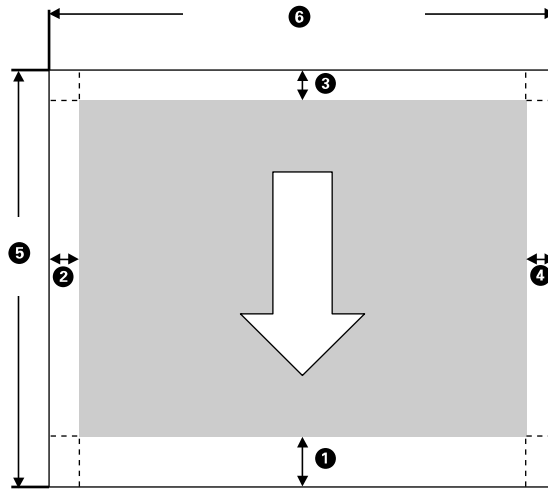

Note: Margins may change depending on the Roll Paper Margin setting that you select. The margins listed here are the default settings. When printing with the left and right borderless setting, the left and right margins are 0. When printing with the borderless on all sides setting, all margins are 0.

- 1 Top margin: 0.59 inch (15 mm) minimum*
- 2 Left margin: 0.12 inch (3 mm) minimum
- 3 Bottom margin: 0.59 inch (15 mm) minimum*
- 4 Right margin: 0.12 inch (3 mm) minimum
- 5 Printable length: 0.4 feet (0.13 m) to 59 feet (18 m)**
- 6 **SureColor P7500 Series:**
Printable width: 10 inches (254 mm) to 24 inches (610 mm)
SureColor P9500 Series:
Printable width: 10 inches (254 mm) to 44 inches (1118 mm)

* For these paper types the default top and bottom margins are 0.8 inch (20 mm): Epson Premium Glossy Photo Paper (250), Epson Premium Semigloss Photo Paper (250), Epson Premium Luster Photo

Paper (260), and Epson Premium Semimatte Photo Paper (250). For Epson UltraSmooth Fine Art Paper, the default top and bottom margins are 1.7 inch (45 mm)

** The maximum printable length using the Epson driver is 59 feet (18 m). To print longer images, you need to use third-party banner printing software and select **Roll Paper (Banner)** as the **Source** setting in the printer driver.

Parent topic: [Technical Specifications](#)

Ink Cartridge Specifications

Note: This product is designed to work with genuine Epson inks. Non-Epson ink or any other ink not specified for this printer could cause damage not covered by Epson's warranties.

Pigment ink	Cyan, Vivid Magenta, Yellow, Light Cyan, Vivid Light Magenta, Orange, Green, Violet, Photo Black, Matte Black, Gray, Light Gray
Cartridge life	Unopened package: do not use if the date on the package has expired
Print quality guarantee	After installation: 1 year

Note: Epson recommends removing and shaking the ink cartridges once every six months.

Temperature	Transporting: -4 to 140 °F (-20 to 60 °C) <ul style="list-style-type: none">• 3 days at 140 °F (60 °C)• 1 month at 104 °F (40 °C)• 4 days at -4 °F (-20 °C) Uninstalled:: -4 to 104 °F (-20 to 40 °C) <ul style="list-style-type: none">• 1 month at 104 °F (40 °C)• 4 days at -4 °F (-20 °C) Installed: 14 to 104 °F (-10 to 40 °C) <ul style="list-style-type: none">• 1 month at 104 °F (40 °C)• 4 days at -4 °F (-20 °C) Ink freezes at -4 °F (-20 °C) Ink thaws and is usable after 4 hours at 77 °F (25 °C)
--------------------	--

Parent topic: [Technical Specifications](#)

Related references

[Ink Cartridge and Maintenance Box Part Numbers](#)

Dimension Specifications

Height	48 inches (1218 mm)
Width	SureColor P7500 Series: 55.1 inches (1401 mm) SureColor P9500 Series: 75.2 inches (1909 mm)
Depth	Printing: 87 inches (2211 mm) with paper basket open Storage: 26.3 inches (667 mm)
Weight (without ink cartridges or optional equipment)	SureColor P7500 Series: Approximately 268.5 lb (121.8 kg) SureColor P9500 Series: Approximately 339.1 lb (153.8 kg)

Parent topic: [Technical Specifications](#)

Electrical Specifications

Power supply rating	100 to 240 V
Rated frequency range	50/60 Hz
Rated current	3.4 to 1.6 A

Power consumption
(approximate)

SureColor P7500 Series:

Printing: 85 W

Ready mode: 32 W

Sleep mode: 3.4 W

Power off mode: 0.3 W or less

SureColor P9500 Series:

Printing: 110 W

Ready mode: 32 W

Sleep mode: 3.4 W

Power off mode: 0.3 W or less

Parent topic: [Technical Specifications](#)

Environmental Specifications

Temperature

Operating: 50 to 95 °F (10 to 35 °C)

Operating (recommended): 59 to 77 °F (15 to 25 °C)

Storage (before unpacking): -4 to 140 °F (-20 to 60 °C)

- 120 hours at 140 °F (60 °C)
- 1 month at 104 °F (40 °C)

Storage (after unpacking; ink charged): 14 to 104 °F (-10 to 40 °C)

- 1 month at 104 °F (40 °C)

Storage (after unpacking; ink discharged): -4 to 77 °F (-20 to 25 °C)

- 1 month at 77 °F (25 °C)

Humidity

(non-condensing)

Operating: 20 to 80% RH

Operating: 40 to 60% RH (recommended)

Storage: 5 to 85% RH

Parent topic: [Technical Specifications](#)

Interface Specifications

USB Interface	Super-Speed USB-Compatible with the Universal Serial Bus Specifications Revision 3.0
Network Interface	100BASE-TX /1000BASE-T

Parent topic: [Technical Specifications](#)

Safety and Approvals Specifications

United States	Safety: UL60950-1 EMC: FCC part 15 Subpart B class B
Canada	Safety: CAN/CSA C22.2 No. 60950-1 EMC: CAN/CSA-CEI/IEC CISPR 22 Class B

This product conforms to Part 15 of FCC Rules and RSS-210 of the IC Rules. Epson cannot accept responsibility for any failure to satisfy the protection requirements resulting from a non-recommended modification of the product. Operation is subject to the following two conditions: (1) this device may not cause harmful interference, and (2) this device must accept any interference received, including interference that may cause undesired operation of the device.

To prevent radio interference to the licensed service, this device is intended to be operated indoors and away from windows to provide maximum shielding. Equipment (or its transmit antenna) that is installed outdoors is subject to licensing.

Parent topic: [Technical Specifications](#)

Notices

Check these sections for important notices about your product.

Note: Epson offers a recycling program for end of life Epson products. Please go to [this site](#) (U.S) or [this site](#) (Canada) for information on how to return your Epson products for proper disposal.

[Important Safety Instructions](#)

[FCC Compliance Statement](#)

[Binding Arbitration and Class Waiver](#)

[Trademarks](#)

[Copyright Notice](#)

Important Safety Instructions

Before using your Epson product, read and follow these safety instructions.

[General Product Safety Instructions](#)

[Ink Cartridge Safety Instructions](#)

[LCD Screen Safety Instructions](#)

Parent topic: [Notices](#)

General Product Safety Instructions

- Be sure to follow all warnings and instructions marked on the product.
- Use only the type of power source indicated on the product's label.
- Use only the power cord that comes with the product. Use of another cord may cause fires or shock. Do not use the cord with any other equipment.
- Place the product near a wall outlet where the plug can be easily unplugged.
- Connect your product to a properly grounded power outlet. Avoid plugging the product into an outlet on the same circuit as a photo copier or air control system that regularly switches on and off, or on an outlet controlled by a wall switch or timer.
- Make sure the plug is fully inserted into the outlet.
- Do not let the power cord become damaged or frayed. Place it to avoid abrasions, cuts, fraying, crimping, and kinking. Do not place objects on top of it and do not allow it to be stepped on or run over. Be careful to keep the cord straight at each end.

- If you use an extension cord with the product, make sure the total ampere rating of the devices plugged into the extension cord does not exceed the cord's ampere rating. Also, make sure the total ampere rating of all devices plugged into the wall outlet does not exceed the wall outlet's ampere rating.
- If damage occurs to the plug, replace the cord set or consult a qualified electrician. If there are fuses in the plug, make sure you replace them with fuses of the correct size and rating.
- Always turn off the product using the power button, and wait until the power light stops flashing before unplugging the product or cutting off power to the electrical outlet.
- If you will not be using the product for a long period, unplug the power cord from the electrical outlet.
- Place the product on a flat, stable surface that extends beyond its base in all directions. It will not operate properly if it is tilted or at an angle.
- Avoid locations that are subject to rapid changes in heat or humidity, shocks or vibrations, or dust.
- Do not place or store the product outdoors.
- Do not place the product near excessive heat sources or in direct sunlight.
- Leave enough room around the product for sufficient ventilation. Do not block or cover openings in the cabinet or insert objects through the slots.
- Keep the product away from potential sources of electromagnetic interference, such as loudspeakers or the base units of cordless telephones.
- When connecting the product to a computer or other device with a cable, ensure the correct orientation of the connectors. Each connector has only one correct orientation. Inserting a connector in the wrong orientation may damage both devices connected by the cable.
- Do not let your hands or hair get caught in the optional Auto Take-up Reel while it is operating.
- Do not spill liquid on the product or use the product with wet hands.
- Do not insert or unplug the plug with wet hands.
- Do not use aerosol products that contain flammable gases inside or around the product. Doing so may cause fire.
- Except as specifically explained in your documentation, do not attempt to service the product yourself.
- Unplug the product and refer servicing to qualified service personnel under the following conditions: if the power cord or plug is damaged; if liquid has entered the product; if the product has been dropped or the cabinet damaged; if the product does not operate normally or exhibits a distinct change in performance. Adjust only those controls that are covered by the operating instructions.
- When storing or transporting the product, do not tilt it, stand it on its side, or turn it upside down; otherwise ink may leak.

Note: The lithium batteries in this product contain Perchlorate Material - special handling may apply. [Click here](#) for details.

Parent topic: [Important Safety Instructions](#)

Ink Cartridge Safety Instructions

- Keep ink cartridges out of the reach of children and do not drink the ink.
- Be careful when you handle used ink cartridges; there may be ink remaining around the ink supply port.
- If ink gets on your skin, wash it off with soap and water. If it gets in your eyes, flush them immediately with water. Failure to observe this precaution could result in bloodshot eyes or mild inflammation. If problems persist, consult a physician. If ink enters your mouth, consult a physician immediately.
- Do not put your hand inside the product or touch any cartridges during printing.
- Install a new ink cartridge immediately after removing an expended one. Leaving cartridges uninstalled can dry out the print head and may prevent the product from printing.
- Install ink cartridges in all the ink cartridge slots. You cannot print if any of the slots are empty.
- Dried ink on the supply port may cause ink leaks when the cartridge is reinserted and used. Wipe off any excess ink before reinserting.
- Do not insert or remove replacement cartridges during printing.
- Do not remove the transparent seal from the ink supply port. This may cause the cartridge to become unusable.
- The green IC chip on this ink cartridge retains a variety of cartridge-related information, such as the ink cartridge status, so that the cartridge may be removed and reinserted freely. Do not touch the green IC chip on the side of the cartridge. This may prevent normal operation and printing.
- If you remove an ink cartridge for later use, protect the ink supply area from dirt and dust and store it in the same environment as the product. Note that there is a valve in the ink supply port, making covers or plugs unnecessary, but care is needed to prevent the ink from staining items that the cartridge touches. Do not touch the ink cartridge ink supply port or surrounding area.
- To ensure print quality, use an ink cartridge before the date printed on its package.
- Do not dismantle or alter an ink cartridge. This could damage the print head and may prevent the product from printing.
- Do not drop cartridges or bump them against hard objects; otherwise, the ink may leak.
- Store ink cartridges at room temperature in a location that is not exposed to direct sunlight.

- After bringing an ink cartridge inside from a cold storage site, allow it to warm up at room temperature for at least four hours before using it.

Parent topic: [Important Safety Instructions](#)

LCD Screen Safety Instructions

- Use only a dry, soft cloth to clean the LCD screen. Do not use liquid or chemical cleansers.
- If the LCD screen is damaged, contact Epson. If the liquid crystal solution gets on your hands, wash them thoroughly with soap and water. If the liquid crystal solution gets into your eyes, flush them immediately with water. If discomfort or vision problems remain after a thorough flushing, see a doctor immediately. If liquid enters your mouth, see a doctor immediately.
- Do not press too hard on the LCD screen or subject it to heavy impacts.
- Do not use a pointy or sharp object, such as a pen or your fingernail, to operate the LCD screen.
- If the LCD screen chips or cracks, do not touch or attempt to remove the broken pieces; contact Epson for support.

Parent topic: [Important Safety Instructions](#)

FCC Compliance Statement

For United States Users

This equipment has been tested and found to comply with the limits for a Class B digital device, pursuant to Part 15 of the FCC Rules. These limits are designed to provide reasonable protection against harmful interference in a residential installation. This equipment generates, uses, and can radiate radio frequency energy and, if not installed and used in accordance with the instructions, may cause harmful interference to radio or television reception. However, there is no guarantee that interference will not occur in a particular installation. If this equipment does cause interference to radio and television reception, which can be determined by turning the equipment off and on, the user is encouraged to try to correct the interference by one or more of the following measures:

- Reorient or relocate the receiving antenna.
- Increase the separation between the equipment and receiver.
- Connect the equipment into an outlet on a circuit different from that to which the receiver is connected.
- Consult the dealer or an experienced radio/TV technician for help.

WARNING

The connection of a non-shielded equipment interface cable to this equipment will invalidate the FCC Certification or Declaration of this device and may cause interference levels which exceed the limits established by the FCC for this equipment. It is the responsibility of the user to obtain and use a shielded equipment interface cable with this device. If this equipment has more than one interface connector, do not leave cables connected to unused interfaces. Changes or modifications not expressly approved by the manufacturer could void the user's authority to operate the equipment.

For Canadian Users

CAN ICES-3(B)/NMB-3(B)

Parent topic: [Notices](#)

Binding Arbitration and Class Waiver

1. DISPUTES, BINDING INDIVIDUAL ARBITRATION, AND WAIVER OF CLASS ACTIONS AND CLASS ARBITRATIONS

1.1 Disputes. The terms of this Section 1 shall apply to all Disputes between you and Epson. The term "Dispute" is meant to have the broadest meaning permissible under law and includes any dispute, claim, controversy or action between you and Epson arising out of or relating to this Agreement, Epson branded products (hardware and including any related software), or other transaction involving you and Epson, whether in contract, warranty, misrepresentation, fraud, tort, intentional tort, statute, regulation, ordinance, or any other legal or equitable basis. "DISPUTE" DOES NOT INCLUDE IP CLAIMS, or more specifically, a claim or cause of action for (a) trademark infringement or dilution, (b) patent infringement, (c) copyright infringement or misuse, or (d) trade secret misappropriation (an "IP Claim"). You and Epson also agree, notwithstanding Section 1.6, that a court, not an arbitrator, may decide if a claim or cause of action is for an IP Claim.

1.2 Binding Arbitration. You and Epson agree that all Disputes shall be resolved by binding arbitration according to this Agreement. **ARBITRATION MEANS THAT YOU WAIVE YOUR RIGHT TO A JUDGE OR JURY IN A COURT PROCEEDING AND YOUR GROUNDS FOR APPEAL ARE LIMITED.**

Pursuant to this Agreement, binding arbitration shall be administered by JAMS, a nationally recognized arbitration authority, pursuant to its code of procedures then in effect for consumer related disputes, but excluding any rules that permit joinder or class actions in arbitration (for more detail on procedure, see Section 1.6 below). You and Epson understand and agree that (a) the Federal Arbitration Act (9 U.S.C. §1, et seq.) governs the interpretation and enforcement of this Section 1, (b) this Agreement memorializes a transaction in interstate commerce, and (c) this Section 1 shall survive termination of this Agreement.

1.3 Pre-Arbitration Steps and Notice. Before submitting a claim for arbitration, you and Epson agree to try, for sixty (60) days, to resolve any Dispute informally. If Epson and you do not reach an agreement to

resolve the Dispute within the sixty (60) days), you or Epson may commence an arbitration. Notice to Epson must be addressed to: Epson America, Inc., ATTN: Legal Department, 3840 Kilroy Airport Way, Long Beach, CA 90806 (the "Epson Address"). The Dispute Notice to you will be sent to the most recent address Epson has in its records for you. For this reason, it is important to notify us if your address changes by emailing us at EAILEgal@ea.epson.com or writing us at the Epson Address above. Notice of the Dispute shall include the sender's name, address and contact information, the facts giving rise to the Dispute, and the relief requested (the "Dispute Notice"). Following receipt of the Dispute Notice, Epson and you agree to act in good faith to resolve the Dispute before commencing arbitration.

1.4 Small Claims Court. Notwithstanding the foregoing, you may bring an individual action in the small claims court of your state or municipality if the action is within that court's jurisdiction and is pending only in that court.

1.5 WAIVER OF CLASS ACTIONS AND CLASS ARBITRATIONS. YOU AND EPSON AGREE THAT EACH PARTY MAY BRING DISPUTES AGAINST THE OTHER PARTY ONLY IN AN INDIVIDUAL CAPACITY, AND NOT AS A PLAINTIFF OR CLASS MEMBER IN ANY CLASS OR REPRESENTATIVE PROCEEDING, INCLUDING WITHOUT LIMITATION FEDERAL OR STATE CLASS ACTIONS, OR CLASS ARBITRATIONS. CLASS ACTION LAWSUITS, CLASS-WIDE ARBITRATIONS, PRIVATE ATTORNEY-GENERAL ACTIONS, AND ANY OTHER PROCEEDING WHERE SOMEONE ACTS IN A REPRESENTATIVE CAPACITY ARE NOT ALLOWED. ACCORDINGLY, UNDER THE ARBITRATION PROCEDURES OUTLINED IN THIS SECTION, AN ARBITRATOR SHALL NOT COMBINE OR CONSOLIDATE MORE THAN ONE PARTY'S CLAIMS WITHOUT THE WRITTEN CONSENT OF ALL AFFECTED PARTIES TO AN ARBITRATION PROCEEDING.

1.6 Arbitration Procedure. If you or Epson commences arbitration, the arbitration shall be governed by the rules of JAMS that are in effect when the arbitration is filed, excluding any rules that permit arbitration on a class or representative basis (the "JAMS Rules"), available at <http://www.jamsadr.com> or by calling 1-800-352-5267, and under the rules set forth in this Agreement. All Disputes shall be resolved by a single neutral arbitrator, and both parties shall have a reasonable opportunity to participate in the selection of the arbitrator. The arbitrator is bound by the terms of this Agreement. The arbitrator, and not any federal, state or local court or agency, shall have exclusive authority to resolve all disputes arising out of or relating to the interpretation, applicability, enforceability or formation of this Agreement, including any claim that all or any part of this Agreement is void or voidable. Notwithstanding this broad delegation of authority to the arbitrator, a court may determine the limited question of whether a claim or cause of action is for an IP Claim, which is excluded from the definition of "Disputes" in Section 1.1 above. The arbitrator shall be empowered to grant whatever relief would be available in a court under law or in equity. The arbitrator may award you the same damages as a court could, and may award declaratory or injunctive relief only in favor of the individual party seeking relief and only to the extent necessary to provide relief warranted by that party's individual claim. In some instances, the costs of arbitration can exceed the costs of litigation and the right to discovery may be more limited in arbitration

than in court. The arbitrator's award is binding and may be entered as a judgment in any court of competent jurisdiction.

You may choose to engage in arbitration hearings by telephone. Arbitration hearings not conducted by telephone shall take place in a location reasonably accessible from your primary residence, or in Orange County, California, at your option.

a) Initiation of Arbitration Proceeding. If either you or Epson decides to arbitrate a Dispute, both parties agree to the following procedure:

(i) Write a Demand for Arbitration. The demand must include a description of the Dispute and the amount of damages sought to be recovered. You can find a copy of a Demand for Arbitration at <http://www.jamsadr.com> ("Demand for Arbitration").

(ii) Send three copies of the Demand for Arbitration, plus the appropriate filing fee, to: JAMS, 500 North State College Blvd., Suite 600 Orange, CA 92868, U.S.A.

(iii) Send one copy of the Demand for Arbitration to the other party (same address as the Dispute Notice), or as otherwise agreed by the parties.

b) Hearing Format. During the arbitration, the amount of any settlement offer made shall not be disclosed to the arbitrator until after the arbitrator determines the amount, if any, to which you or Epson is entitled. The discovery or exchange of non-privileged information relevant to the Dispute may be allowed during the arbitration.

c) Arbitration Fees. Epson shall pay, or (if applicable) reimburse you for, all JAMS filings and arbitrator fees for any arbitration commenced (by you or Epson) pursuant to provisions of this Agreement.

d) Award in Your Favor. For Disputes in which you or Epson seeks \$75,000 or less in damages exclusive of attorney's fees and costs, if the arbitrator's decision results in an award to you in an amount greater than Epson's last written offer, if any, to settle the Dispute, Epson will: (i) pay you \$1,000 or the amount of the award, whichever is greater; (ii) pay you twice the amount of your reasonable attorney's fees, if any; and (iii) reimburse you for any expenses (including expert witness fees and costs) that your attorney reasonably accrues for investigating, preparing, and pursuing the Dispute in arbitration. Except as agreed upon by you and Epson in writing, the arbitrator shall determine the amount of fees, costs, and expenses to be paid by Epson pursuant to this Section 1.6d).

e) Attorney's Fees. Epson will not seek its attorney's fees and expenses for any arbitration commenced involving a Dispute under this Agreement. Your right to attorney's fees and expenses under Section 1.6d) above does not limit your rights to attorney's fees and expenses under applicable law; notwithstanding the foregoing, the arbitrator may not award duplicative awards of attorney's fees and expenses.

1.7 Opt-out. You may elect to opt-out (exclude yourself) from the final, binding, individual arbitration procedure and waiver of class and representative proceedings specified in this Agreement by sending a written letter to the Epson Address within thirty (30) days of your assent

to this Agreement (including without limitation the purchase, download, installation of the Software or other applicable use of Epson Hardware, products and services) that specifies (i) your name, (ii) your mailing address, and (iii) your request to be excluded from the final, binding individual arbitration procedure and waiver of class and representative proceedings specified in this Section 1. In the event that you opt-out consistent with the procedure set forth above, all other terms shall continue to apply, including the requirement to provide notice prior to litigation.

1.8 Amendments to Section 1. Notwithstanding any provision in this Agreement to the contrary, you and Epson agree that if Epson makes any future amendments to the dispute resolution procedure and class action waiver provisions (other than a change to Epson's address) in this Agreement, Epson will obtain your affirmative assent to the applicable amendment. If you do not affirmatively assent to the applicable amendment, you are agreeing that you will arbitrate any Dispute between the parties in accordance with the language of this Section 1 (or resolve disputes as provided for in Section 1.7, if you timely elected to opt-out when you first assented to this Agreement).

1.9 Severability. If any provision in this Section 1 is found to be unenforceable, that provision shall be severed with the remainder of this Agreement remaining in full force and effect. **The foregoing shall not apply to the prohibition against class or representative actions as provided in Section 1.5. This means that if Section 1.5 is found to be unenforceable, the entire Section 1 (but only Section 1) shall be null and void.**

Parent topic: [Notices](#)

Trademarks

EPSON®, PrecisionCore®, SureColor®, and SpectroProofer® are registered trademarks and EPSON Exceed Your Vision is a registered logomark of Seiko Epson Corporation.

Epson StoreSM is a service mark of Epson America, Inc.

Mac and OS X are trademarks of Apple Inc., registered in the U.S. and other countries.

Windows is a registered trademark of Microsoft Corporation in the United States and/or other countries.

General Notice: Other product names used herein are for identification purposes only and may be trademarks of their respective owners. Epson disclaims any and all rights in those marks.



Parent topic: [Notices](#)

Copyright Notice

All rights reserved. No part of this publication may be reproduced, stored in a retrieval system, or transmitted in any form or by any means, electronic, mechanical, photocopying, recording, or otherwise, without the prior written permission of Seiko Epson Corporation. The information contained herein is designed only for use with this Epson product. Epson is not responsible for any use of this information as applied to other products.

Neither Seiko Epson Corporation nor its affiliates shall be liable to the purchaser of this product or third parties for damages, losses, costs, or expenses incurred by purchaser or third parties as a result of: accident, misuse, or abuse of this product or unauthorized modifications, repairs, or alterations to this product, or (excluding the U.S.) failure to strictly comply with Seiko Epson Corporation's operating and maintenance instructions.

Seiko Epson Corporation shall not be liable for any damages or problems arising from the use of any options or any consumable products other than those designated as Original Epson Products or Epson Approved Products by Seiko Epson Corporation.

Seiko Epson Corporation shall not be held liable for any damage resulting from electromagnetic interference that occurs from the use of any interface cables other than those designated as Epson approved Products by Seiko Epson Corporation.

This information is subject to change without notice.

[A Note Concerning Responsible Use of Copyrighted Materials](#)
[Default Delay Times for Power Management for Epson Products](#)
[Copyright Attribution](#)

Parent topic: [Notices](#)

A Note Concerning Responsible Use of Copyrighted Materials

Epson encourages each user to be responsible and respectful of the copyright laws when using any Epson product. While some countries' laws permit limited copying or reuse of copyrighted material in certain circumstances, those circumstances may not be as broad as some people assume. Contact your legal advisor for any questions regarding copyright law.

Parent topic: [Copyright Notice](#)

Default Delay Times for Power Management for Epson Products

This product will enter sleep mode after a period of nonuse. This is to ensure that the product meets Energy Star standards of energy efficiency. More energy savings can be achieved by setting the time to sleep to a shorter interval.

Parent topic: [Copyright Notice](#)

Copyright Attribution

© 2020 Epson America, Inc.

3/20

CPD-58368R1

Parent topic: [Copyright Notice](#)