

SC-F6400 Series
SC-F6400H Series

User's Guide

Copyrights and Trademarks

Copyrights and Trademarks

No part of this publication may be reproduced, stored in a retrieval system, or transmitted in any form or by any means, electronic, mechanical, photocopying, recording, or otherwise, without the prior written permission of Seiko Epson Corporation. The information contained herein is designed only for use with this Epson printer. Epson is not responsible for any use of this information as applied to other printers.

Neither Seiko Epson Corporation nor its affiliates shall be liable to the purchaser of this product or third parties for damages, losses, costs, or expenses incurred by the purchaser or third parties as a result of accident, misuse, or abuse of this product or unauthorized modifications, repairs, or alterations to this product, or (excluding the U.S.) failure to strictly comply with Seiko Epson Corporation's operating and maintenance instructions.

Seiko Epson Corporation shall not be liable for any damages or problems arising from the use of any options or any consumable products other than those designated as Original Epson Products or Epson Approved Products by Seiko Epson Corporation.

Seiko Epson Corporation shall not be held liable for any damage resulting from electromagnetic interference that occurs from the use of any interface cables other than those designated as Epson Approved Products by Seiko Epson Corporation.

EPSON, EPSON EXCEED YOUR VISION, EXCEED YOUR VISION and their logos are registered trademarks or trademarks of Seiko Epson Corporation.

Microsoft® and Windows® are registered trademarks of Microsoft Corporation.

Mac and OS X are registered trademarks of Apple Inc.

Intel® is a registered trademark of Intel Corporation.

Adobe, Acrobat, Illustrator, and Reader are either registered trademarks or trademarks of Adobe in the United States and/or other countries.

YouTube® and the YouTube logo are registered trademarks or trademarks of YouTube, LLC.

Chrome is a trademark of Google LLC.

Firefox is a trademark of the Mozilla Foundation in the U.S. and other countries.

General Notice: Other product names used herein are for identification purposes only and may be trademarks of their respective owners. Epson disclaims any and all rights in those marks.

© 2022 Seiko Epson Corporation. All rights reserved.

Copyrights and Trademarks

Note for North American and Latin American Users

IMPORTANT: Before using this product, make sure you read the safety instructions in the online *Notices*.

Contents

Copyrights and Trademarks

Note for North American and Latin American Users 3

Introduction

Notes on Manuals.	6
Meaning of Symbols.	6
Screenshots.	6
Illustrations.	6
Manual Organization.	6
Printer Parts.	9
Front Section.	9
Inside.	12
Back.	14
Roll adapter.	15
Control panel.	16
Understanding and Operating the Display.	17
Notes on Usage and Storage.	24
Installation space.	24
Notes when using the printer.	24
Notes when not using the printer.	24
Notes on Handling Ink Supply Units.	25
Handling Media.	26
Software Supplied.	27
Software Supplied (Windows).	27
Software Supplied (Mac).	28
Using Epson Edge Print (Windows only).	30
Starting Procedure.	30
Acquiring and Registering EMX Files.	30
Closing Procedure.	30
Using Epson Edge Dashboard.	30
Starting Procedure.	30
Registering the Printer.	31
Download the EMX File.	31
Closing Procedure.	31
Using EPSON Software Updater (Windows).	31
Checking Software Update Availability.	31
Receiving Update Notifications.	32
Using Web Config.	32
Starting Procedure.	32
Closing Procedure.	33
Uninstalling Software.	33

Basic Operations

Workflow for Correct Printing. 34

Registering Media Settings to the Printer.	34
Notes When Handling Media.	35
Notes on Loading Media.	35
Loading Media.	36
Make settings for Loaded Media.	36
Using the Auto Take-up Reel Unit (An Optional Item for the SC-F6400/SC-F6430/SC-F6440/SC-F6460).	37
Important Points for Correct Take-up.	38
Loading into the Auto Take-up Reel Unit.	38
Printing.	41
Removing Media.	41
Cutting Media.	42
Removing the Take-up Roll.	42
Removing Media.	43
Optimizing Media Settings (Print Head Alignment and Media Feed Adjustment).	44
Print Head Alignment.	44
Media Feed Adjustment.	45
Adjusting the Amount of Media Fed While Printing.	47
Printable area.	48

Maintenance

When to Perform Various Maintenance Operations.	51
Regular Maintenance.	51
Refilling and Replacing Consumables.	52
What You'll Need.	54
Precautions Regarding Maintenance.	54
Performing Regular Maintenance.	56
Cleaning the Capping Station and Wiper.	56
Cleaning the Platen.	57
Cleaning the Vent.	58
Shaking the Ink Supply Units Periodically.	58
Precautions When Shaking.	58
Shaking.	59
Replacing Ink Supply Units.	59
Precautions When Replacing.	59
Replacement Procedure.	60
Disposing of Waste Ink.	60
Precautions When Replacing the Waste Ink Bottle.	60
Replacing the Waste Ink Bottle.	61
Print Head Maintenance.	62

Contents

Replacing the Auto Cutter Blade.	63
Replacement Procedure.	63
Precautions when Replacing the Auto Cutter Blade.	64
Handling Used Consumables.	64
Print Head Nozzle Check.	64
Head Cleaning.	65
Types of Cleaning.	65
Performing Head Cleaning.	65

Control Panel Menu

Menu List.	66
Details of the Menu.	71
General Settings Menu.	71
Media Settings Menu.	78
Maintenance Menu.	82
Supply Status Menu.	82
Replacement Part Information Menu.	83
Printer Status Menu.	83

Problem Solver

When a Message is Displayed.	84
When a Maintenance Call/Service Call Occurs.	85
Troubleshooting.	86
You Cannot Print (Because the Printer Does Not Work).	86
The Printer Sounds Like It Is Printing, but Nothing Prints.	86
The Prints Are Not What You Expected.	88
Feeding or Ejecting Problems.	92
Others.	92

Appendix

Options and Consumable Products.	94
Ink Supply Units.	94
Others.	96
Supported Media.	98
Moving and Transporting the Printer.	98
Moving the Printer.	98
Transport.	99
Media Settings List for Each Media Type.	100
System Requirements.	101
Epson Edge Dashboard.	101
Epson Edge Print.	102
Web Config.	102
Specifications Table.	103





Introduction

Introduction

Notes on Manuals

Meaning of Symbols

To prevent injury to customers or third parties and damage to property, this manual uses the following symbols to warn of dangerous operations and handling. Make sure you understand the meaning of these symbols before reading this manual.

 Warning:	Warnings must be followed to avoid serious bodily injury.
 Caution:	Cautions must be followed to avoid bodily injury.
 Important:	Important must be followed to avoid damage to this product.
Note:	Notes contain useful or additional information on the operation of this product.
	Indicates related reference content.

Screenshots

Screenshots used in this manual may differ slightly from the actual screens.

Illustrations

Unless otherwise specified, the illustrations in this manual are for the SC-F6400H Series.

The illustrations may differ slightly from the model you are using. Please be aware of this when using the manual.

Manual Organization

North America

To view user manuals, visit <https://epson.com/support> (U.S.) or <https://epson.ca/support> (Canada) and search for your product.

Latin America

To view user manuals, visit <https://latin.epson.com/support> (Caribbean), <https://epson.com.br/suporte> (Brazil), or <https://latin.epson.com/soporte> (other regions) and search for your product.

Other Regions

The manuals for the product are organized as shown below.

You can view the PDF manuals using Adobe Reader or Preview (Mac).

Setup Guide (booklet)	Provides information on how to setup the printer after unpacking it from the box. Make sure you read this manual to perform operations safely.
General Information	Provides product specifications and contact information.
Safety Instructions	Provides instructions that should be followed to prevent injury to customers or third parties and damage to property. Make sure you read this to ensure the product is used safely and correctly. For some regions, this content is included in the Setup Guide.
Epson Support (PDF)	Provides information about Epson Support for each region.
Online Manual	

Introduction

User's Guide (PDF)	This manual explains how to use the printer.
Epson Video Manuals	These videos show you how to load media and perform maintenance.
Network Guide (PDF)	This manual provides information on using the printer over a network.
Epson Support (PDF)	Provides information about Epson Support for each region.

Viewing Video Manuals

The video manuals have been uploaded to YouTube.

Click [Epson Video Manuals (video)] on the top page of the Online Manual, or click the following blue text to view the manuals.

Epson Video Manuals

If the subtitles are not displayed when you play the video, click the subtitles icon shown in the image below.

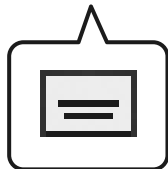

Viewing PDF Manuals

This section uses Adobe Acrobat Reader DC as an example to explain the basic operations for viewing the PDF in Adobe Reader.

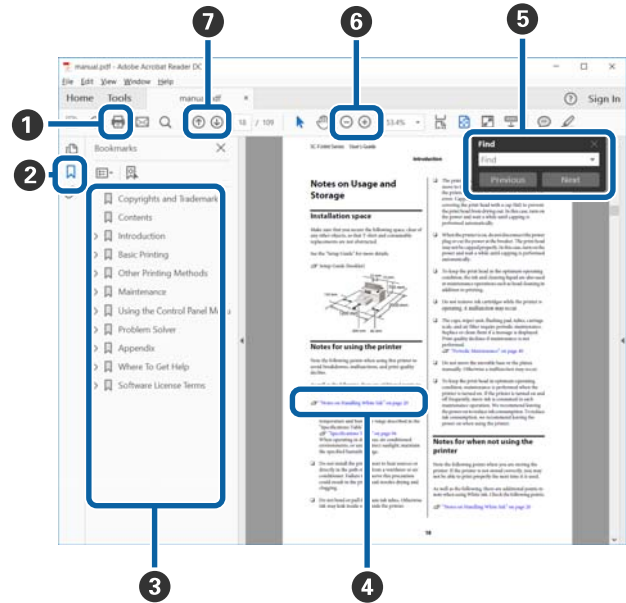

- 1 Click to print the PDF manual.
- 2 Each time it is clicked the bookmarks are hidden or shown.
- 3 Click the title to open the relevant page.
Click [+] to open the titles lower in the hierarchy.
- 4 If the reference is in blue text, click the blue text to open the relevant page.

To return to the original page, do the following.

For Windows

While pressing the Alt key, press the ← key.

For Mac

While pressing the command key, press the ← key.

Introduction

- 5 You can input and search for keywords, such as the names of items you want to confirm.

For Windows

Right click on a page in the PDF manual and select **Find** in the menu that is displayed to open the search toolbar.

For Mac

Select **Find** in the **Edit** menu to open the search toolbar.

- 6 To enlarge the text in the display that is too small to see well, click \oplus . Click \ominus to reduce the size. To specify a part of an illustration or screenshot to enlarge, do the following.

For Windows

Right click on the page in the PDF manual and select **Marquee Zoom** in the menu that is displayed. The pointer changes to a magnifying glass, and you can use it to specify the range of the place you want to enlarge.

For Mac

Click the **View** menu - **Zoom** - **Marquee Zoom** in this order to change the pointer to a magnifying glass. Use the pointer as a magnifying glass to specify the range of the place you want to enlarge.

- 7 Opens the previous page or next page.

Introduction

Printer Parts

Front Section

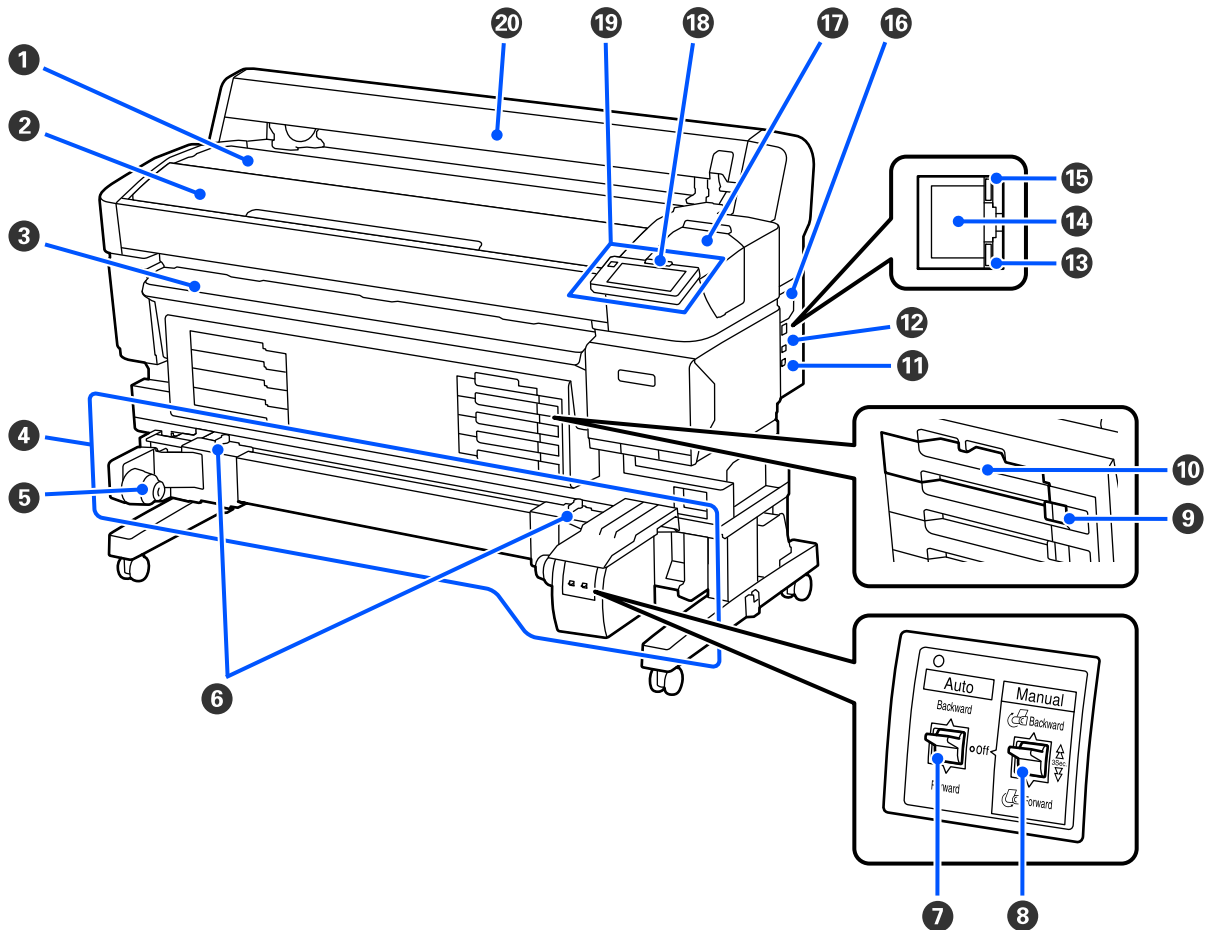

1 Roll rest

Place the media here when attaching/removing the roll adapter to load/remove it.

2 Printer cover

Open this cover when cleaning the printer or clearing jams.

3 Output guide

Smoothly guides media output from the printer.

4 Auto Take-up Reel Unit (an optional item for the SC-F6400/SC-F6430/SC-F6440/SC-F6460)

5 Roll core holder

Place the roll core for media take-up on these holders. There are same parts on both the left and the right.

Introduction

6 Lock levers

Release the lock to adjust the position of the roll core holder. These locks are on the left and right roll core holders.

7 Auto switch

Use this switch to select the auto take-up direction. When this is set to Off, winding is not performed.

8 Manual switch

Use this switch for manual take up. This is available when the Auto switch is set to Off.

9 Lock switch

To pull out an ink supply unit tray, unlock it by moving the lock switch to the right. After placing the ink supply unit tray in the ink unit, lock it by moving the lock switch to the left.

The SC-F6400H Series also has a lock switch on the left side.

10 Ink supply unit tray

Insert the ink supply unit for the color indicated on the label. Insert all of the ink supply unit trays. The SC-F6400H Series also has an ink supply unit tray on the left side.

11 Option port

Connect the cable for the auto take-up reel unit. Be sure to use the cable supplied.

12 USB port

Connects the USB cable.

13 Data lamp

The data lamp lights or flashes to indicate the network connection status and whether the printer is receiving data.

On : Connected.

Flashing : Receiving data.

14 LAN port

Connects the LAN cable.

15 Status lamp

The color indicates the network's communication speed.

Red : 100Base-TX

Green : 1000Base-T

Introduction

16 Vent

Allows air to flow into the printer. Do not block the vent.

Needs to be cleaned once a month or when dust is noticeable.

 [“Cleaning the Vent” on page 58](#)

17 Maintenance cover

Open when cleaning the capping station or the wiper.

18 Alert lamp

This lamp lights or flashes when an error occurs.

Light/Flash: An error occurred. How the lamp lights or flashes varies with the type of error. The control panel displays a description of the error.

Off : No error.

19 Control panel

 [“Control panel” on page 16](#)

20 Media cover

Cover to protect the media. Except when loading or removing media, it should be closed when using the printer.

Introduction

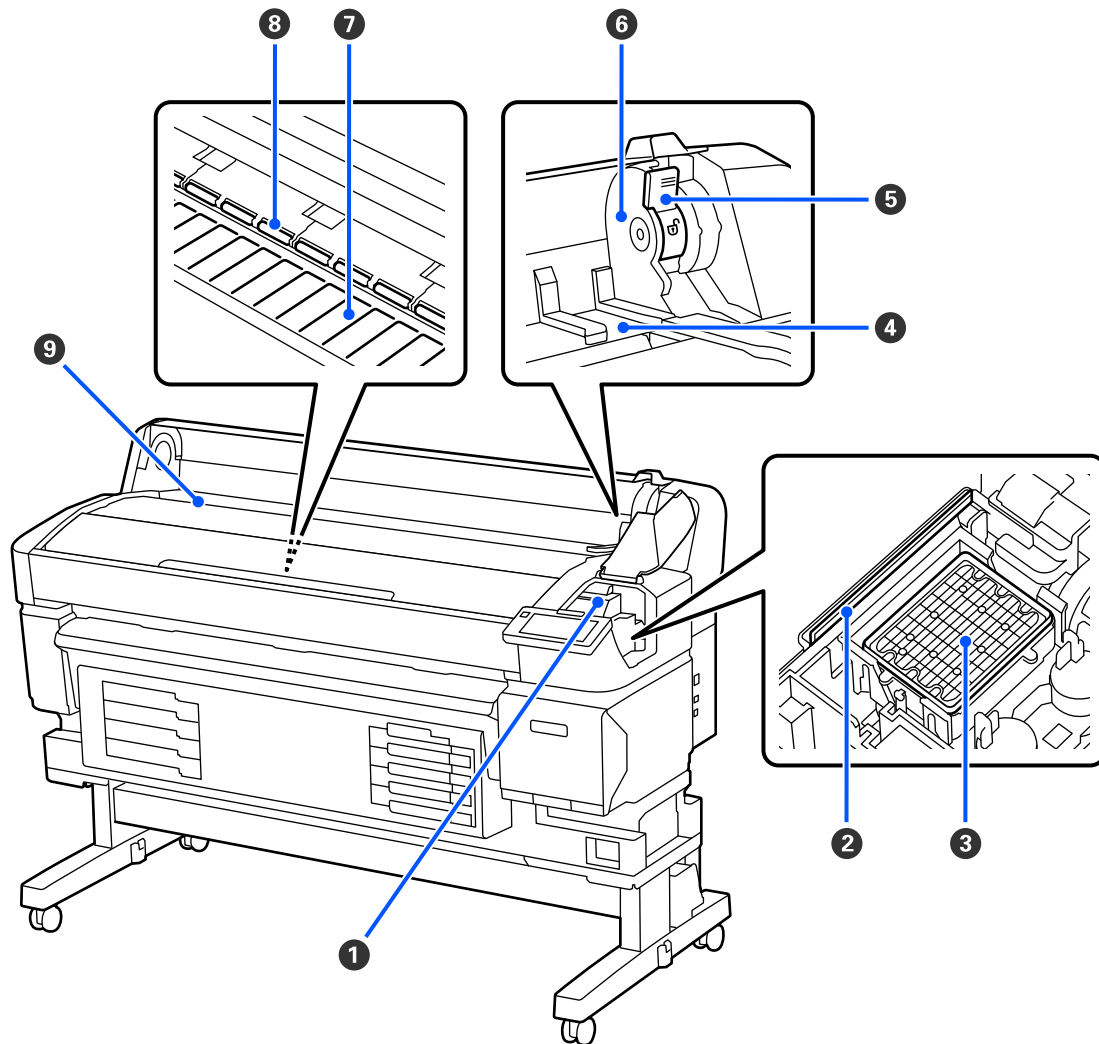
Inside
**1 Print head**

The print head prints by moving left and right while emitting ink. Clean if the printouts are dirty.

 [“If ink drops occur” on page 88](#)

 [“When horizontal lines appear or the colors are wrong” on page 88](#)

2 Wiper

The wiper removes ink from the print head nozzles.

Needs to be cleaned at least once a month.

 [“Cleaning the Capping Station and Wiper” on page 56](#)

Introduction

③ Capping station

Except during printing, these caps cover the print head nozzles to prevent them from drying out. Needs to be cleaned at least once a month.

 [“Cleaning the Capping Station and Wiper” on page 56](#)

④ Roll adapter guide

Guides for attaching media. Move the media along these guides to attach it to the adapter holder.

 [“Loading Media” on page 36](#)

⑤ Roll lock lever

A lever that locks media in place after the roll is attached to the adapter holder.

⑥ Adapter holder

The roll adapter is placed in this holder after the media is attached.

⑦ Platen

This part suctions the media for printing. Needs to be cleaned at least once a month.

 [“Cleaning the Platen” on page 57](#)

⑧ Rollers

These rollers press down on the media during printing.

⑨ Input slot

Input slot used when printing with media.

Introduction

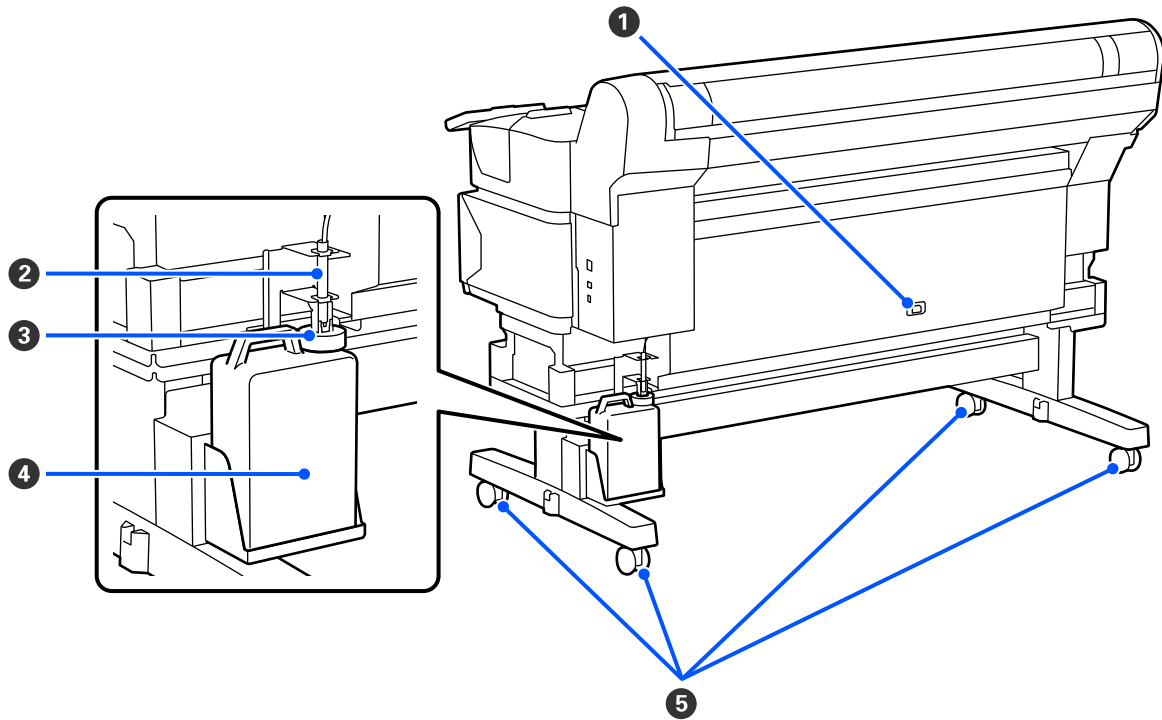
Back**1 AC inlet**

Connect the supplied power cable here.

2 Waste ink tube

Waste ink is discharged from this tube. Be sure the end of this tube is in the Waste Ink Bottle while the printer is in use.

3 Stopper

The stopper prevents splatter when the waste ink is ejected.

Fit the stopper closely to the mouth of the waste ink bottle except when replacing the waste ink bottle.

4 Waste Ink Bottle

Waste ink collects in this bottle.

Replace with a new Waste Ink Bottle when the level approaches the line.

5 Casters

There are two casters on each leg. Once installation is complete, the casters should be kept locked while the printer is in use.

Roll adapter

Use the supplied roll adapter when loading media into the printer.

 [“Loading Media” on page 36](#)

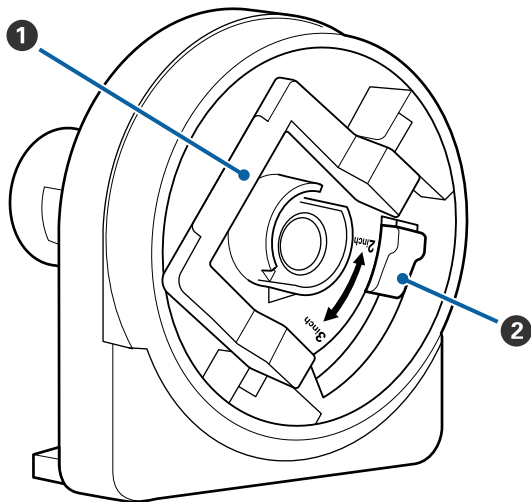

1 Adapter lock lever

Lift to unlock, lower to lock. Unlock the lever when attaching to the media, and lock it after attaching.

2 Size lever

Position according to the size of the roll core for the media.

Introduction

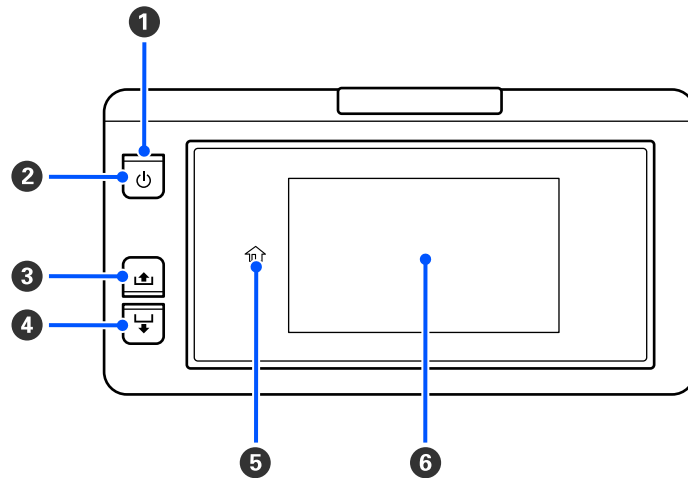
Control panel
**1**  **Light (power light)**

The printer's operational status is indicated by a lit or flashing light.

On  : The power is on.

Flashi  : The printer is operating such as receiving data, shutting down, or performing Head Cleaning.

Off  : The power is off.

2  **Button (power button)**

Turns the power on and off.

3  **button (rewind button)**

You can rewind the media by holding down the button.

4  **button (feed button)**

You can feed the media by holding down the button.

5  **Home)**

Press to return to the home screen during menu operations and so on (when  is lit).

 (Home) is not lit when it cannot be used.

6 **Screen**

Displays the printer's status, menus, error messages, and so on.  [“Understanding and Operating the Display” on page 17](#)

Understanding and Operating the Display

Understanding the Display

This section explains how to view the Home screen.

The Home screen has the following two layouts and you can switch between them by pressing .

Home screen (status display)

You can check the current status of the printer.

Home screen (adjust while printing)

You can quickly change the major adjustment values. You can also make adjustments while printing.

Home screen (status display)

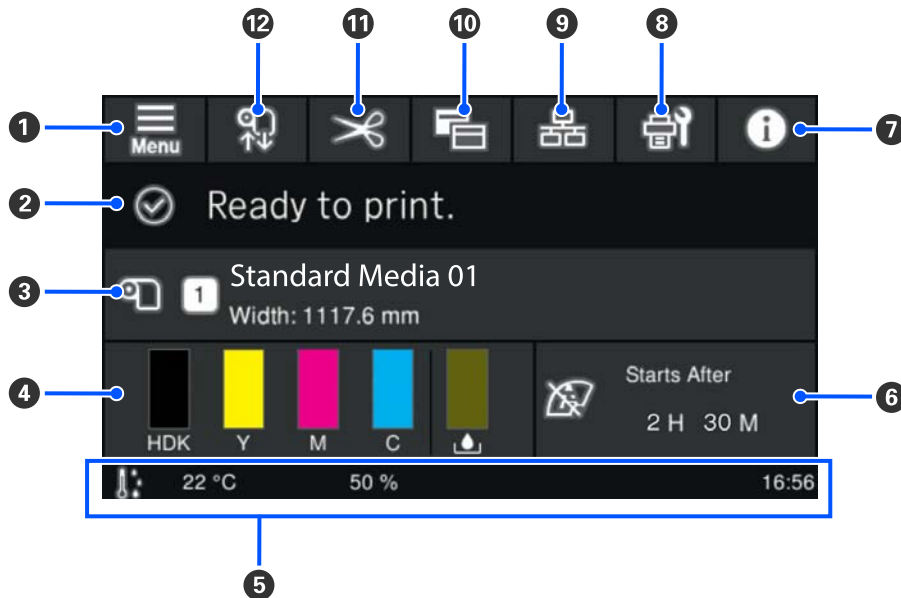

1 (menu)

The settings menu will be displayed.

 ["Control Panel Menu" on page 66](#)

Introduction

2 Status display area

Displays the printer's status and warning messages. Only the most recent notifications are shown in this area. You can check all warning notifications by pressing .

When a print job is received, the displayed content changes as shown below. The following provides an explanation of each display.

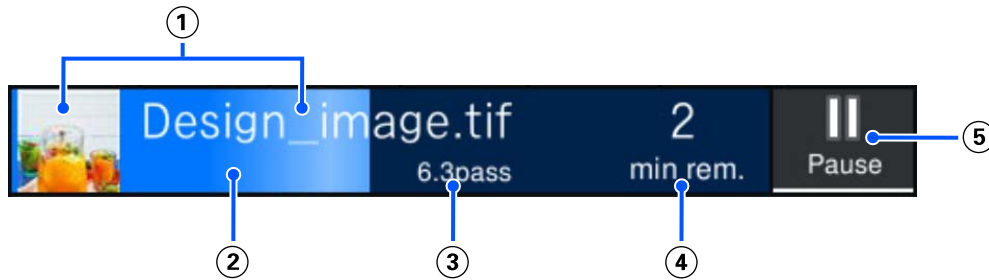

- ① Displays a preview of the image being printed and the file name.
- ② Displays a progress bar showing the printing progress.
- ③ Displays the Printed Length for the media, Remaining Print Length for the media, Time until media replacement, or the Pass Mode.

Pressing the display area while printing displays the screen to set the display details for ③. Select one item that you want to display.

Time until media replacement displays the estimated time.

- ④ Displays the estimated time until printing is complete.
- ⑤ This is the Pause (Suspend) button.

3 Media info

Displays the name and number of the currently selected registered media, as well as the width of the currently loaded media. When **Remaining Amount Management** is set to **On**, the remaining amount of the loaded media is also displayed. Pressing this area displays the **Media Settings** from the settings menu where you can change to a different registered media number or change the settings for the media number that is currently selected.

4 Status of consumables

Displays the approximate amount remaining and the status of consumables such as the ink supply unit. Pressing this area allows you to check details for the amount remaining and the part number of each consumable.

The following provides an explanation of each display.

Introduction



Ink supply unit status

Indicates the approximate amount of ink remaining. The bar goes lower as the remaining ink runs low. The letters under the bar are abbreviations of the colors. The relation of the abbreviations and the ink colors is shown below.

The colors displayed vary depending on the printer and ink you are using.

HDK : High Density Black

Y : Yellow

M : Magenta

C : Cyan

LM : Light Magenta

LC : Light Cyan

OR : Orange

V : Violet

FY : Fluorescent yellow

FP : Fluorescent pink

Depending on the status of the ink supply unit, the display of the bar changes as shown below.



: Ink is low. You need to prepare a new ink supply unit.



: Ink is expended. Replace the old ink supply unit with a new one.



: It is time to shake the ink supply unit. Pull out the ink supply unit tray and shake it.



Waste ink bottle status

Indicates the approximate amount of space available in the waste ink bottle. The bar goes lower as the amount of remaining space decreases.



: The waste ink bottle is almost full. Prepare a new waste ink bottle.

5 Environmental temperature, humidity, and time

Displays the current temperature, humidity, and time. You may not be able to print correctly unless you use the printer under the appropriate environmental conditions.

Introduction



6 Notice on when to perform maintenance or Periodic Cleaning

Displays the remaining print duration, print page counter, or print length until maintenance or Periodic Cleaning is performed.

You can press this area to perform Head Cleaning if necessary.

Also, maintenance cleaning may be performed regardless of the notification when the printer is turned back on.

7 (Printer Status)

If a warning notification has been generated,  is displayed on the right just like . Press **Message List** on the screen displayed when you press this area to display a list of warning notifications. You can check detailed information and the handling procedure for each item by pressing it in the list. Items are removed from the list as those actions are taken.

8 (Maintenance)

The Maintenance menu is displayed on this screen and you can perform operations such as print head maintenance and replacing consumables.

9 (Switch connection status)

The following icons indicate the connection status between the computer and the printer.

Connection : 
on

Connection : 
off

The connection turns on or off every time this area is pressed.

For example, you can finish work more efficiently by turning the connection off to prevent jobs from being received before performing maintenance such as printing a nozzle check pattern or executing Head Cleaning after cleaning around the print head.

Note that you may not be able to switch depending on the operating status of the printer. In this situation, the icon is grayed out indicating that the function is disabled.

10 (Switch screens)

Switch between the Home screen (status display) and the Home screen (adjust while printing) every time this area is pressed.

11 (Cut)

Press to manually cut media using the built-in cutter.

 [“Cutting Media” on page 42](#)

Introduction

12 (Load and remove media)

Press when loading or removing media.

 [“Loading Media” on page 36](#)

 [“Removing Media” on page 43](#)

Home screen (adjust while printing)

The following section only describes parts that differ from the Home screen (status display). You can change the value for each adjustment item even while printing. Results of the adjustments are registered to the currently selected Media Settings.

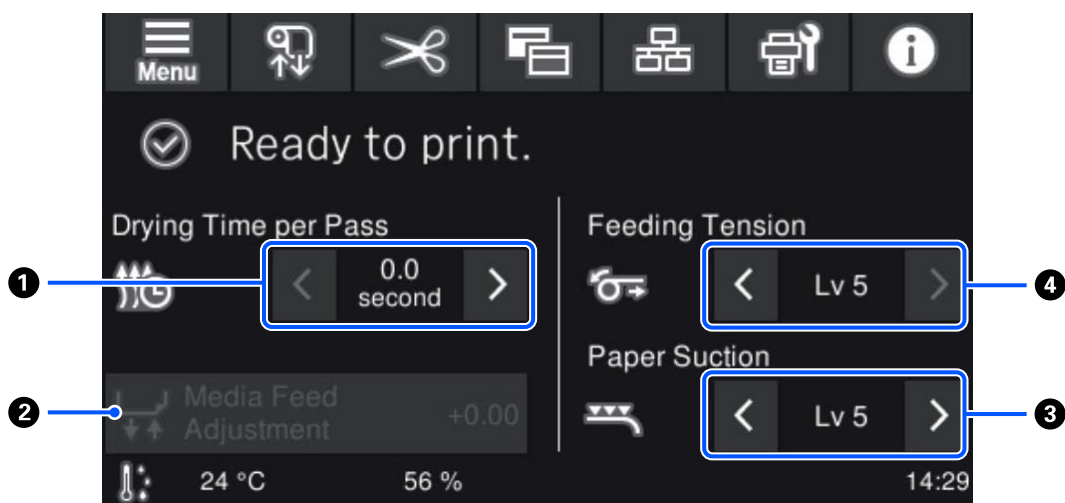

1 Adjust Drying Time per Pass

Displays the **Drying Time per Pass** setting for the selected Pass Mode for the currently selected registered media number. Press the following to change the value.

 : To reduce the display time

 : To increase the display time

2 Media Feed Adjustment

To correct banding that occurs during printing, press this area to perform media feed corrections.

If the feed amount is too small, black bands (dark stripes) appear; correct the feed amount upwards (+).

In contrast, if the feed amount is too large, white bands (pale stripes) appear; correct the feed amount downwards (-). The value indicates the amount of feed that has been corrected as a percentage or as a positive (+) or negative (-) value.



Introduction

3 Adjust Paper Suction

Set the strength of the suction by the platen on the media. The higher the value, the greater the suction.



In most situations, use the values set for each media type as they are. If the media is wavy on the platen, increase the set value.

If graininess or out-of-focus characteristics are detected in printing results obtained using thin or soft media or if the media is not fed normally, reduce the set value.

Pressing  /  allows you to change the values.

4 Adjust Feeding Tension

Increase tension if creases appear in the media during printing. The higher the value, the greater the tension.

Pressing  /  allows you to change the values.

Operating procedure

The black background area on the home screen does not respond even if you press it. When you press the gray tiled area in the operation area, the screen or the value changes.

Depending on the printer's operating status, you may not be able to perform the function for every button displayed at the top of the screen. If the function is unavailable, the icon is grayed out and the button does not respond.

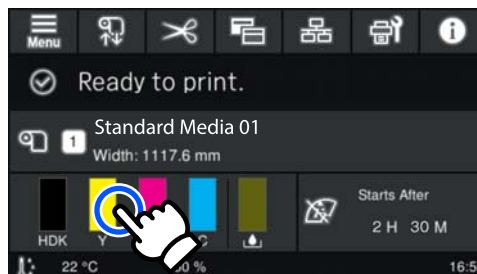

Operation areas do operations when pressed. However, when a scroll bar is displayed as shown below, you can scroll the screen by moving (sliding) your finger up and down on the screen. You can also scroll by pressing on the up and down icons on the scroll bar.

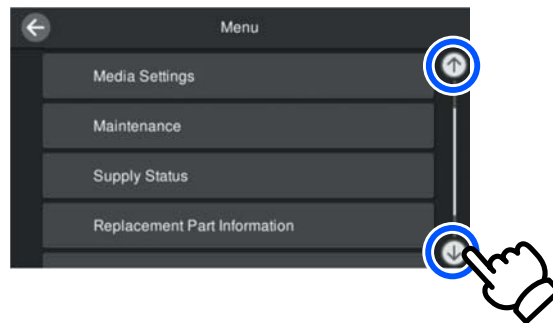
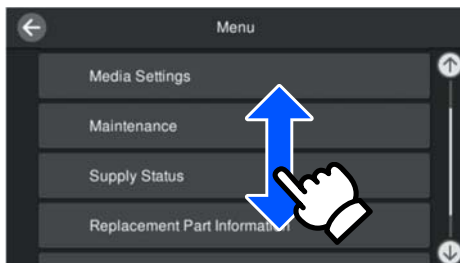

Introduction

If the following **How To...** button is displayed on a message screen and so on, you can press this button to view a guide for the operating procedure.

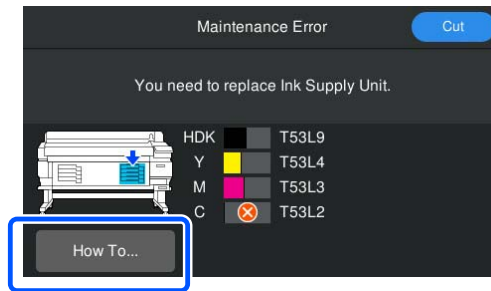

Notes on Usage and Storage

Installation space

North American and Latin American users:

Contact your dealer for product installation. The product must be installed by an authorized dealer. Damage to the product from unauthorized installation will not be covered by your Epson warranty.

Other regions:

Make sure that you secure the following space, clear of any other objects, so that paper ejection and consumable replacement are not obstructed.

See the "Specifications Table" for the external dimensions of the printer.

 ["Specifications Table" on page 103](#)

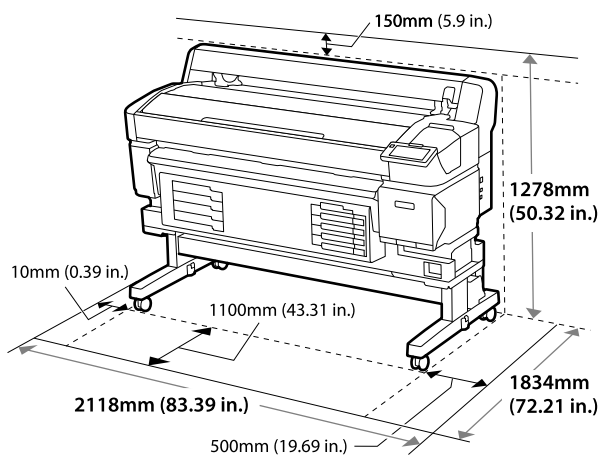

Notes when using the printer

Note the following points when using this printer to avoid breakdowns, malfunctions, and print quality decline.

- ❑ When using the printer, follow the operating temperature and humidity range described in the "Specifications Table".  ["Specifications Table" on page 103](#)
Note, however, that the desired results may not be achieved if the temperature and humidity are within the limits for the printer but not within those for the media. Be sure the operating

conditions suit the media. For more information, see the documentation supplied with the media. Also, when operating in dry areas, air conditioned environment, or under direct sunlight, maintain the appropriate humidity.

- ❑ Make sure the work space is kept clean. If dust or lint enter into the printer, it could damage the printer, clog the print head nozzles, or cause the quality of media feeding to decline.
- ❑ Avoid using the printer in locations with heat sources or that are exposed to direct draughts from ventilators or air conditioners. The print head nozzles could dry out and clog.
- ❑ Use the printer in a location that is sufficiently ventilated.
- ❑ The print head may not be capped (i.e., may not move to the right-hand side) if an error occurs and the printer is turned off without first resolving the error. Capping is a function for automatically covering the print head with a cap (lid) to prevent the print head from drying out. In this case, turn on the power and wait a while until capping is performed automatically.
- ❑ When the power is on, do not remove the power plug or cut the power at the breaker. Otherwise, the print head may not be capped properly. In this case, turn on the power and wait a while until capping is performed automatically.
- ❑ Do not bend or tug the waste ink tube. Ink could spill inside or around the printer.
- ❑ As well as being expended during printing, ink is used during Head Cleaning and other maintenance operations required to keep the print head in working order.
Be sure that the Waste Ink Bottle is placed whenever the printer is on.
- ❑ For stable color printing, maintain a constant room temperature of 15 to 25 °C (59 to 77 °F).

Notes when not using the printer

If you are not using it, note the following points when storing the printer. If it is not stored correctly, you may not be able to print properly the next time it is used.

Introduction

- ❑ If you do not print for a long time, the print head nozzles may become dried out and clogged. Turn the printer on at least once every six weeks to prevent the print head clogging. Head Cleaning is performed automatically after the printer is turned on and started. Do not turn the printer off until Head Cleaning is complete. Leaving the printer for too long without turning it on may result in a malfunction. If repairs are necessary, they may require a fee depending on your region.
- ❑ If the operation above cannot be performed, a service engineer must perform pre- and post-maintenance. Depending on your region, pre- and post-maintenance may require a fee. Moreover, depending on the environment and length of time stored, repairs may be required during post-maintenance even if pre-maintenance is done. If repairs are necessary, they may require a fee depending on your region. Contact your dealer or Epson Support.
- ❑ The rollers may crease media left in the printer. This can also cause wavy or curled media resulting in paper feeding problems or the print head could be scratched. Remove the media before putting the printer in storage.
- ❑ Store the printer after confirming that the print head has been capped (the print head is positioned at the far right). If the print head is left uncapped for a long time, the print quality may decline.

Note:

If the print head is not capped, turn the printer on, and then turn it off.

- ❑ To prevent the accumulation of dust and other foreign matter in the printer, close all covers before placing it in storage. If you are not using the printer for a long time, put an anti-static cloth or cover on the printer. The print head nozzles are very small, and they can become clogged easily if fine dust gets on the print head, and you may not be able to print properly.
- ❑ When turned on after an extended period of disuse, the printer may automatically perform Head Cleaning to ensure print quality. Head Cleaning will end after about 5 to 7 minutes.

- ❑ Also see the following section, "Notes on Handling Ink Supply Units".

Notes on Handling Ink Supply Units

Note the following points when handling ink supply units to maintain good print quality.

- ❑ Extra ink is required to fully charge the print head nozzles the first time the printer is used; therefore, replacement ink supply units will be needed earlier than usual.
- ❑ Store ink supply units at room temperature out of direct sunlight.
- ❑ To ensure print quality, we recommend using all of the ink before whichever of the following dates is earlier:
 - ❑ The expiry date shown on the ink supply unit packaging
 - ❑ One year from the date the ink supply unit was installed in the ink unit
- ❑ If you move the ink supply units from a cold place to a warm place, leave them at room temperature for more than four hours before using them.
- ❑ Do not touch the IC chip on the ink supply unit. You may not be able to print properly.
- ❑ Because the IC chip manages the information for the ink supply unit, such as the remaining ink level, you can still re-insert and use them if you removed them before the replacement message appears.
- ❑ While ink supply units are in storage, keep the ink supply ports free of dust. The ink supply port has a valve in it so it does not need to be capped.
- ❑ Removed ink supply units may have ink around the ink supply port, so be careful not to get any ink on the surrounding area when removing the ink supply units.
- ❑ To maintain the quality of the print head, this printer stops printing before ink supply units are completely expended.

Introduction

- ❑ Although the ink supply units may contain recycled materials, this does not affect printer function or performance.
- ❑ Do not dismantle or remodel ink supply units. You may not be able to print properly.
- ❑ Do not drop or knock an ink supply unit against hard objects; otherwise, the ink may leak from the ink supply unit.
- ❑ Ink supply units installed in the printer must be removed and thoroughly shaken once every week for High Density Black, and once every three weeks for other colors.
👉 “Shaking” on page 59
- ❑ Due to the characteristics of the ink, the color of the ink supply unit may change. This does not affect the quality.

Handling Media

Note the following when handling or storing media. Media that are in poor condition will not produce good quality prints.

Be sure to read the documentation provided with each type of media.

Notes on Handling

- ❑ Do not fold the media or damage the printable surface.
- ❑ Do not touch the printable surface. Moisture and oils from your hands can affect print quality.
- ❑ When handling media, hold it by both edges. We recommend wearing cotton gloves.
- ❑ Keep the media dry.
- ❑ Packaging materials can be used to store media and should not be thrown away.
- ❑ Avoid locations that are subject to direct sunlight, excessive heat, or humidity.

- ❑ When not in use, media should be removed from the printer, rewound, and inserted in its original packaging for storage. Leaving media in the printer for extended periods may cause it to deteriorate.

Handling Media After Printing

To maintain long lasting, high quality print results, note the following points.

- ❑ Do not rub or scratch the printed surface. If they are rubbed or scratched, the ink may peel off.
- ❑ Do not touch the printed surface, as this may remove the ink.
- ❑ Make sure printouts are completely dry before folding or stacking. If the printouts are stacked or taken up without being dried sufficiently, the print surface may be damaged.
- ❑ Avoid direct sunlight.
- ❑ To prevent discoloration, store prints as instructed in the documentation supplied with the media.

Introduction

Software Supplied

The software for the printer is provided using different methods and with different content for Windows and Mac.

Note:

Support for Mac varies by region.

 [“Software Supplied \(Windows\)” on page 27](#)

 [“Software Supplied \(Mac\)” on page 28](#)

Note:

Printer drivers are not provided. A software RIP is required for printing. “Epson Edge Print”, Epson’s software RIP for Windows, is supplied with the printer.

The Epson web site provides supported plug-in software for the printer.

Software Supplied (Windows)

The software to help you get the best out of the printer is available on the following optical discs supplied with the printer, or on the Epson web site. There is also software pre-loaded in the printer.

- Software disc
- Epson Edge Print
 -  [“Using Epson Edge Print \(Windows only\)” on page 30](#)

Software supplied on the software disc

North America

An Epson Edge Print CD is included with this printer. To view and download additional software, visit <https://epson.com/support> (U.S.) or <https://epson.ca/support> (Canada) and search for your product.

Latin America

An Epson Edge Print CD is included with this printer. To view and download additional software, visit <https://latin.epson.com/support> (Caribbean), <https://epson.com.br/suporte> (Brazil), or <https://latin.epson.com/suporte> (other regions) and search for your product.

Other Regions

If your computer does not have a disc drive, you can install from <https://epson.sn>.

For more information on each software application, see the online help for each software application.

Introduction

Software Name	Summary
EPSON Software Updater	<ul style="list-style-type: none"> <input type="checkbox"/> The software checks if new software or update information is available on the Internet and installs it. You can also update the manuals for the printer. <input type="checkbox"/> Notifies you when a printer firmware update is available. You can download and update the latest firmware by following the wizard.
Epson communications drivers	Epson communications drivers are required when using Epson Edge Dashboard or Epson Edge Print, or when using a commercial RIP to connect a computer and the printer by USB. Make sure these are installed.
EpsonNet Config SE	With this software, you can configure various network settings for the printer from your computer. This is useful as it allows you to enter addresses and names using the keyboard.

Epson Edge Dashboard (available on the Epson web site)

After installation, it operates as resident software. It provides the following control operations for Epson printers.

- Notifies you of the status of registered printers when you are using a commercial software RIP.
- You can download print settings files (EMX files) provided by Epson. When using a commercial software RIP, import the downloaded EMX file into the commercial software RIP to use it.
- You can monitor the status of the printer connected to a computer with Epson Edge Dashboard installed over a network or USB connection.
- You can easily make and change media settings from a computer and write to the printer.

 [“Using Epson Edge Dashboard” on page 30](#)

Note:

The provided EMX files differ according to the country and region in which you live.

Web Config (pre-loaded in the printer)

This software is pre-installed on the printer. You can start it from a web browser via a network.

This software is for network administrators.

You can configure the network security settings from Web Config. It also provides an e-mail notification function to inform you when errors and so on occur in the printer.

 [“Using Web Config” on page 32](#)

Software Supplied (Mac)

The optical disc supplied is for Windows only. The following two types of software are supplied for Mac.

Note:

Support for Mac varies by region.

Introduction

Epson Edge Dashboard (available on the Epson web site)

After installation, it operates as resident software. The following features are available.

- ❑ You can receive notifications on updating the printer firmware, and update the firmware.
- ❑ Notifies you of the status of registered printers when you are using a commercial software RIP.
- ❑ You can download print settings files (EMX files) provided by Epson over a network. Import the downloaded EMX file into the commercial software RIP to use it.
- ❑ You can monitor the status of the printer connected to a computer with Epson Edge Dashboard installed over a network or USB connection.
- ❑ You can easily make and change media settings from a computer and write to the printer.

 [“Using Epson Edge Dashboard” on page 30](#)

Note:

The provided EMX files differ according to the country and region in which you live.

Web Config (pre-loaded in the printer)

This software is pre-installed on the printer. You can start it from a web browser via a network.

This software is for network administrators.

You can configure the network security settings from Web Config. It also provides an e-mail notification function to inform you when errors and so on occur in the printer.

 [“Using Web Config” on page 32](#)

Using Epson Edge Print (Windows only)

Starting Procedure

The application can be launched using any of the following methods.

- ❑ Double click the shortcut icon created on the desktop.
- ❑ Click the Windows Start button - **All Programs - Epson Software - Epson Edge Print.**

For more information, see the Epson Edge Print online help.

Acquiring and Registering EMX Files

To print correctly on the media you are using, you must register the print information and the media setting values that are appropriate for the media you are using to the printer and to Epson Edge Print.

You can use print setting files (EMX files) from Epson, which provide optimum print quality settings for the commercially available media being used (the provided files differ according to the country and region in which you live).

See the following for details on EMX files.

 [“Registering Media Settings to the Printer” on page 34](#)

Epson Edge Print allows you to easily perform the following operations in wizard format.

- ❑ Download EMX files
- ❑ Automatically register print information to Epson Edge Print
- ❑ Register media settings to the specified registered media number of the printer

For more details on how to acquire and register EMX files, see the Epson Edge Print help.

Closing Procedure

Select **Done** from **File** at the top left of the screen.

Using Epson Edge Dashboard

Starting Procedure

Epson Edge Dashboard is a Web application.

1

The application can be launched using either of the following two methods.

Windows

- ❑ Double click the **Epson Edge Dashboard** icon on the desktop. The **Epson Edge Dashboard** icon is created when this application is installed.

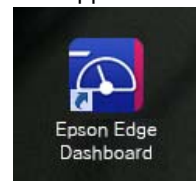

- ❑ Click **Start - All Programs (or Programs) - Epson Software - Epson Edge Dashboard.**

Mac

- ❑ Click the **Epson Edge Dashboard** icon displayed on the menu bar of the desktop, and select **Show Epson Edge Dashboard.**



- ❑ Double-click the **Applications - Epson Software - Epson Edge Dashboard - Epson Edge Dashboard** icon.

2

Epson Edge Dashboard starts.

For more information, see the Epson Edge Dashboard online help.

Introduction

Registering the Printer

Epson Edge Dashboard can monitor, manage, and copy Media Settings to registered printers.

For Windows, printers are registered automatically, allowing you to monitor and manage them immediately after starting the Epson Edge Dashboard. If your printer is not automatically registered, check that you are using it under the following conditions.

- A communication driver provided with the printer has been installed on a computer
- The computer and printer are connected
- The printer is on standby

Printers are not automatically registered for Mac. Register your printer manually from the Register Printer screen. This screen is displayed when you start Epson Edge Dashboard for the first time. For details, see the Epson Edge Dashboard help.

Download the EMX File

To print correctly on the media you are using, you must register the print information and the media setting values that are appropriate for the media you are using to the printer and to the commercial software RIP.

You can use print setting file (EMX file) provided by Epson, which provides optimum print quality settings for the commercially available media being used. (The provided files differ according to the country and region in which you live.)

See the following for details on EMX files.

 [“Registering Media Settings to the Printer” on page 34](#)

After downloading an EMX file, you need to perform the following steps.

- Copy the media settings to the printer.
For details, see the Epson Edge Dashboard help.
- Import the print information (print settings) into a commercial software RIP.
See the manual for your software RIP for details.

Closing Procedure

Close the Web browser. However, since Epson Edge Dashboard is a resident software, it does not stop running.

Using EPSON Software Updater (Windows)

Note:

EPSON Software Updater is not available in all regions.

North American users:

To check for software updates, visit <https://epson.com/support> (U.S.) or <https://epson.ca/support> (Canada) and search for your product.

Latin American users:

To check for software updates, visit <https://latin.epson.com/support> (Caribbean), <https://epson.com.br/suporte> (Brazil), or <https://latin.epson.com/suporte> (other regions) and search for your product.

Checking Software Update Availability

- 1** Check the following status.
 - The computer is connected to the Internet.
 - The printer and the computer can communicate.

- 2** Start EPSON Software Updater.

Windows 8.1/Windows 8

Enter the software name in the search charm, and select the icon displayed.

Except for Windows 8.1/Windows 8

Click Start - **All Programs** (or **Programs**) - **Epson Software** - **EPSON Software Updater**.

Introduction

Note:

You can also start by clicking the printer icon on the desktop taskbar and selecting **Software Update**.

- 3 Select your printer, and then click  to check for the latest software.

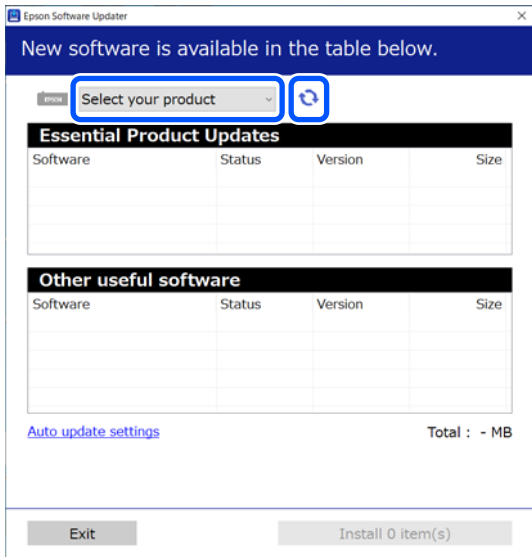

- 4 Select the software and manuals you want to update, and then click the Install button to start the installation.

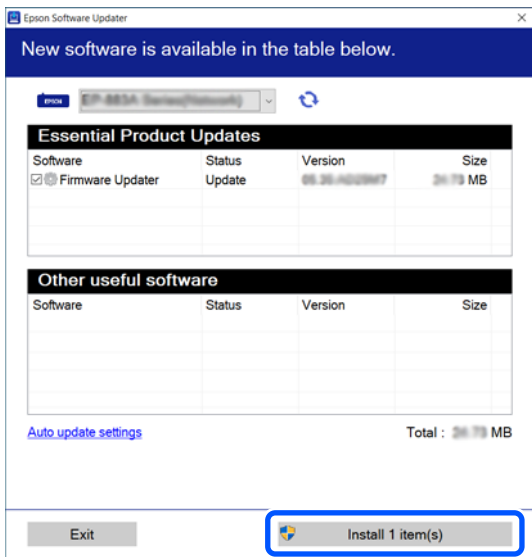

When Firmware Updater is displayed, the latest firmware is available. Select Firmware Updater and click the Install button to automatically start Firmware Updater and update the printer firmware.

Follow the on-screen instructions.

 **Important:**

Do not turn off the computer or printer while updating.

Receiving Update Notifications

- 1 Start EPSON Software Updater.
- 2 Click **Auto update settings**.
- 3 Select an interval for checking for updates on the printer's **Interval to Check** box, and then click **OK**.

Using Web Config

Provides an overview of starting the software and the functions provided.

Starting Procedure

Start the software on a computer that is connected to the same network as the printer.

- 1 Check the printer's IP address.
Confirm that the printer is ready to print. Press  (menu), and then select **General Settings - Network Settings - Wired LAN Status**.
- 2 Start a Web browser on the computer that is connected to the printer over the network.
- 3 Enter the IP address of the printer in the address bar of the Web browser and press the **Enter** or **Return** key.

Format:

IPv4: http://IP address of printer/

IPv6: http://[IP address of printer]/

Example:

IPv4: http://192.168.100.201/

IPv6: http://[2001:db8::1000:1]/

Introduction

Closing Procedure

Close the Web browser.

Uninstalling Software

Important:

- Log into a "Computer administrator" account (an account with administrative privileges).
- Enter the administrator password when prompted and then proceed with the remainder of the operation.
- Exit any other applications that may be running.

Windows

This section describes how to uninstall applications using Epson Edge Dashboard and the Epson communications drivers as an example.

- 1** Turn off the printer, and disconnect the cable from the computer.
- 2** On the computer on which the software is installed, click **Control Panel**, and then click **Uninstall a program** from the **Programs** category.
- 3** Select the software you want to remove and then click **Uninstall/Change** (or **Change/Remove**).
Selecting the following deletes the Epson communications drivers. The model number appears in XXXXX.
 - EPSON SC-SXXXXX Series Comm Driver Printer Uninstall

To uninstall Epson Edge Dashboard, select **Epson Edge Dashboard**.
- 4** Select the target printer icon, and then click **OK**.

- 5** Follow the on-screen instructions to continue.
When the delete confirmation message appears, click **Yes**.

If you are reinstalling the Epson communications drivers, restart the computer.

Mac

The following describes how to remove Epson Edge Dashboard.

- 1** Close **Epson Edge Dashboard**.
- 2** Double-click **Applications - Epson Software - Epson Edge Dashboard - Epson Edge Dashboard Uninstaller**.
Follow the on-screen instructions to continue.

Basic Operations

Workflow for Correct Printing

Follow the instructions below to print correctly on your media.

1. Register media settings to the printer

To print in the optimum conditions for the media you are using, you must register the print information and the setting values that are appropriate for the media you are using to the printer and the RIP. You can easily register media settings to the printer using the following method.

["Registering Media Settings to the Printer" on page 34](#)



2. Load media

["Loading Media" on page 36](#)



3. Make settings for loaded media

["Make settings for Loaded Media" on page 36](#)



4. Load into the auto take-up reel unit

To print while winding up the media, you need to attach the media to the auto take-up reel unit.

This is optional for the SC-F6400/SC-F6430/SC-F6440/SC-F6460.

["Loading into the Auto Take-up Reel Unit" on page 38](#)



5. Print

["Printing" on page 41](#)

Registering Media Settings to the Printer

You can register media settings in one of the following ways.

Using the general-purpose media settings that are pre-registered in the printer

This printer has three pre-registered media types according to the paper weight of the media. When you select a media type, the printer prints using the general-purpose media settings appropriate for each paper weight.

After loading the media, select the media type appropriate for the loaded media in Media Settings.

["Make settings for Loaded Media" on page 36](#)

Downloading an EMX file and registering the settings

An EMX file provided by Epson is a single print settings file containing the following information necessary to print properly on commercially available media (the provided files differ according to the country and region in which you live).

- Print Information:** Settings for ICC profiles that are used in RIP, the number of passes, the resolution, and so on
- Media Settings:** The settings that are registered to the printer's Media Management for the Platen Gap, Feeding Tension, and so on, that are appropriate for the media you are using.

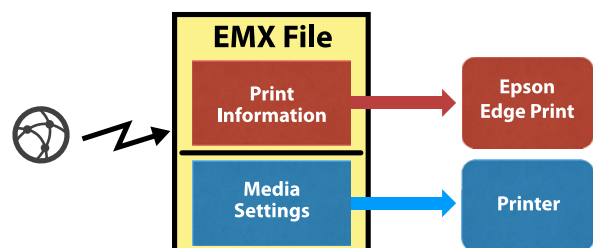

Basic Operations

When using the software RIP Epson Edge Print supplied with the printer, download the EMX file from Epson Edge Print.

 [“Using Epson Edge Print \(Windows only\)” on page 30](#)

When using a commercial software RIP, download the EMX file using Epson Edge Dashboard.

 [“Using Epson Edge Dashboard” on page 30](#)

Notes When Handling Media

If the following points are not observed when handling media, small amounts of dust and lint may stick to the media surface and cause ink drops in the print results or cause the nozzles to clog.

Do not place exposed media directly on the floor.

Media should be rewound and inserted in its original packaging for storage.

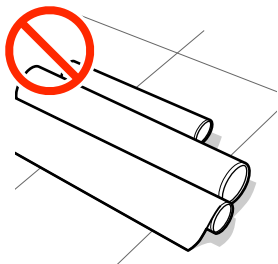

Do not carry media with the media surface pressed against clothing.

Handle paper in its individual packaging until just before loading the paper in the printer.

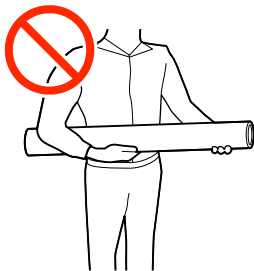

Notes on Loading Media

Caution:

Do not rub your hands along the edges of the media. The edges of the media are sharp and can cause injury.

Load the media just before printing.

The rollers may crease media left in the printer. The media may also become wavy or curled, causing jams or resulting in the media coming into contact with the print head.

Do not load media if the right and left edges are uneven.

If media is loaded and the right and left edges of the roll are uneven, media feeding problems may cause the media to move around during printing. Either rewind to align the edges or use a roll without any issues.

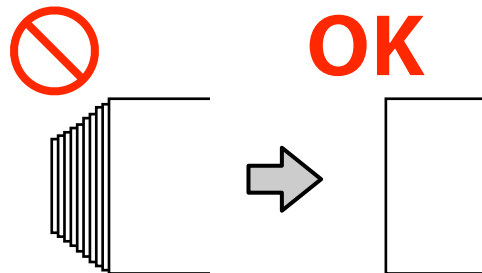

Media that cannot be used

Do not use media that is folded, wrinkled, scuffed, torn, or dirty. The media could rise up and contact the printheads and damage them.

Do not use paper that is frayed at the ends of the roll, wrinkled, torn, and so on, as shown in the following image.

Basic Operations



Loading Media

As shown below, you can load media while checking the procedure on the panel screen.

You can also watch the video on YouTube.

[Epson Video Manuals](#)

- 1 Check that **Load the media.** is displayed on the screen, and then press .

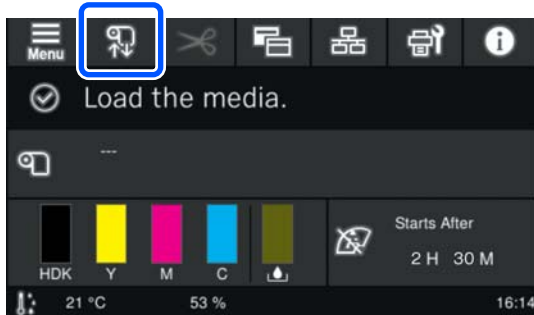

- 2 Press **Start - See Description** on the screen to view the procedure.

Follow the on-screen instructions to perform the procedure.

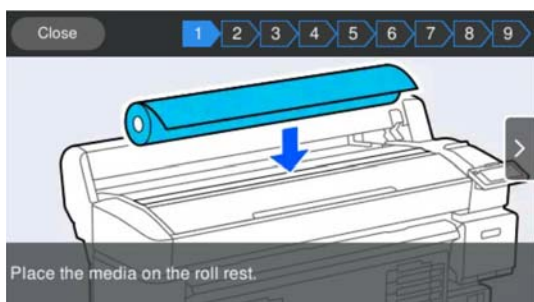

Make settings for Loaded Media

Make settings for the loaded media.

- 1 Press **Media** to select the registered media number that contains the settings corresponding to the loaded media.

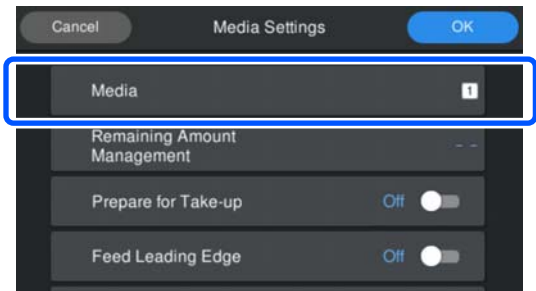

When Media Settings have not been registered for the loaded media

In this situation, select an unregistered number.

In an unregistered status, the Media Type is set to **Med-Thick 70g/m²**. If the paper weight of the loaded media is 61 to 89 g/m², you can leave this as it is.

Change the media type if the paper weight differs from that of the loaded media. Failure to select the appropriate Media Type could cause problems with print quality.

To change the media type, press  - **Edit - Media Type** on the screen where the registered media number is displayed.

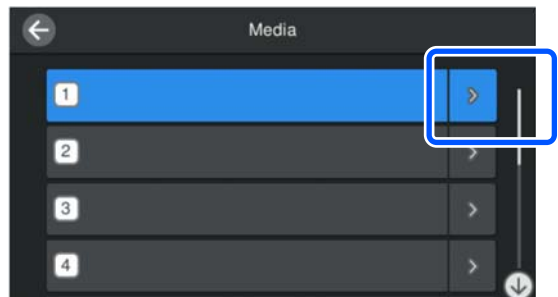

Select the Media Type using the paper weight of the loaded media as a guideline as shown below. The paper weights of each Media Type shown on the screen are typical values.

After making your selection, press the **Close** button.

Basic Operations

Media Type	Paper weight (g/m ²)
Thin 50g/m ²	60 or under
Med-Thick 70g/m ²	61 to 89
Thick 120g/m ²	90 or over

When Media Settings have been registered for the loaded media/EMX files have already been downloaded

Select the registered media number.

- 2** If necessary, set the operation to be performed when feeding paper.

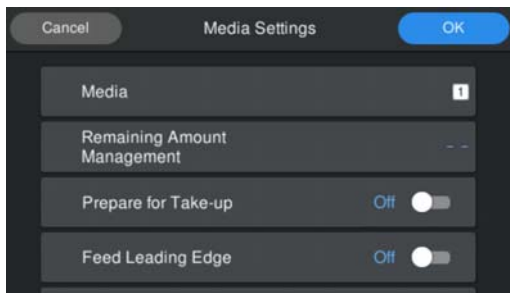

The following provides the details of each operation.

Prepare for Take-up	<p>Displayed when the optional auto take-up reel unit is installed.</p> <p>Set this to On to continue loading media into the take-up unit after feeding. After feeding the media, the media continues to be fed up to the area surrounding the take-up roll core.</p> <p>This is automatically set to On when print data is being received.</p>
Cut Leading Edge	<p>Set this to On if the leading edge of the loaded media is not horizontal or not cut neatly. The leading edge of the media is cut when paper feeding starts.</p>
Feed Leading Edge	<p>Set this to On when the amount of media remaining is printed on the leading edge of the loaded media. The printed part is fed to the leading edge of the media when paper feeding starts.</p>

Note:

When the printer is ready to print, set **Remaining Amount Management** and **Media Detection** if necessary.

Remaining Amount Management

To make settings, press (menu) on the screen, and then press **Media Settings - Remaining Amount Management**.

[“Media Settings Menu” on page 78](#)

Media Detection

To make settings, press (menu) on the screen, and then press **General Settings - Printer Setup - Media Detection**.

[“General Settings Menu” on page 71](#)

- 3** When the settings are complete, press **OK**. Paper feeding starts.

See the following when the auto take-up reel unit is not installed or **Prepare for Take-up** is set to **Off**.

[“Printing” on page 41](#)

See the following when **Prepare for Take-up** is set to **On**.

[“Loading into the Auto Take-up Reel Unit” on page 38](#)

Using the Auto Take-up Reel Unit (An Optional Item for the SC-F6400/ SC-F6430/SC-F6440/ SC-F6460)

The auto take-up reel unit automatically takes up media as it is printed.

The auto take-up reel unit for this printer can take up paper in either of the directions shown below.

Printed side in
(recommended)

Printed side out

Basic Operations

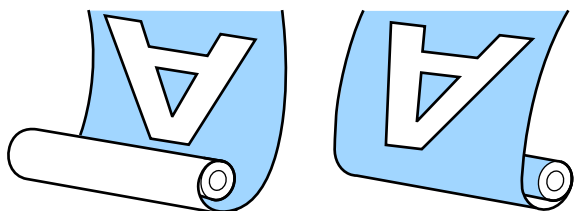

Taking-up with printed side in places the printed surface on the inside of the roll.

Taking-up with printed side out places the printed surface on the outside of the roll.

You can check the procedure in a video on YouTube.

[Epson Video Manuals](#)

Caution:

- ❑ Follow the instructions in the manual when loading media or roll cores or removing media from the take-up roll.
Dropping media, roll cores, or take-up rolls could result in injury.
- ❑ Be careful that your hands, hair, or other objects do not get caught in the moving parts of the auto take-up reel unit.
Failure to observe this precaution could result in injury.

Note:

For information on installing the auto take-up reel unit, see the Setup Guide.

North American and Latin American users:

Contact your dealer for product installation information. Damage to the product from unauthorized installation will not be covered by your Epson warranty.

Important Points for Correct Take-up

Observe the following points for correct take-up of media.

- ❑ We recommend using a take-up roll core with the same width as the media. If a take-up roll core of a different width is used, the take-up roll core may bend, and the media will be taken up incorrectly.
- ❑ We recommend “printed side in” for the take-up of media. “Printed side out” may cause the media to move around and create a large misalignment with the roll.
- ❑ Do not attach take-up roll cores like the ones shown in the following figure. The take-up tension will be uneven and the core will spin loosely. As a result, the paper cannot wind correctly, which may cause banding in the print results.

Edges are worn



Deformed



- ❑ Depending on the media type and media width, the media may become misaligned with the roll or too loose and then cause an Auto Take-up Reel Unit Error when taking up over a long distance.
 [“When a Message is Displayed” on page 84](#)

Loading into the Auto Take-up Reel Unit

You need the following items when loading media into the auto take-up reel unit. Prepare these in advances to start work smoothly.

Basic Operations

- ❑ Take-up roll core that is the same width as the media
- ❑ Commercially available adhesive tape

1 Set the Auto switch on the Auto Take-up Reel Unit to off.

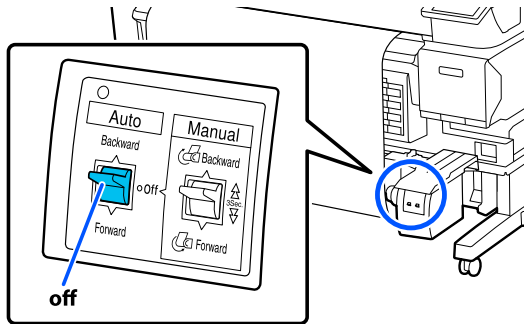

2 Release the left-side lock lever.

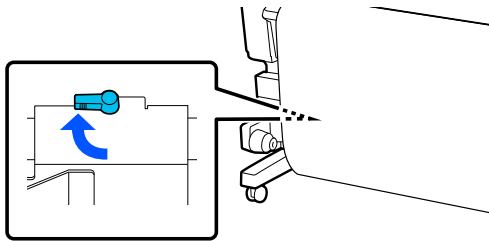

3 Move the roll core holder until it is outside the width of the media.

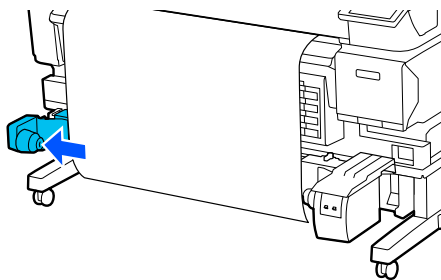

4 Release the right-side lock lever.

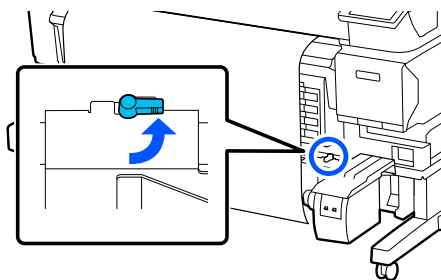

5 Align the right-side roll core holder with the edge of the media.

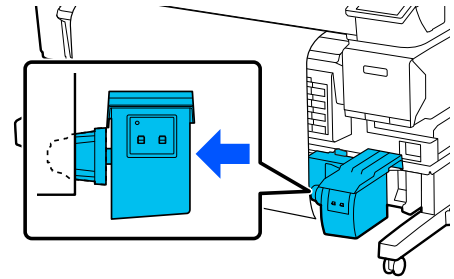

6 Move the lock lever on the roll core holder to the lock position to secure the roll core holder.

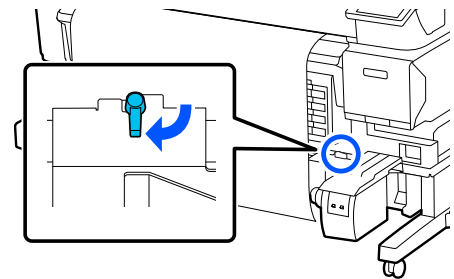

7 Insert the roll core onto the roll core holder.

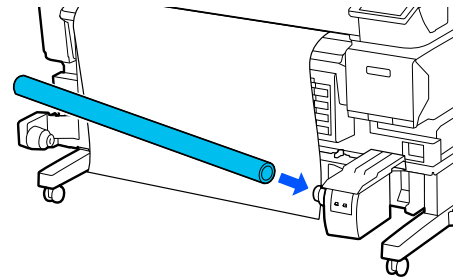

8 Make sure the roll core holder is inserted into the roll core and that the roll core and the edges of the media are aligned.

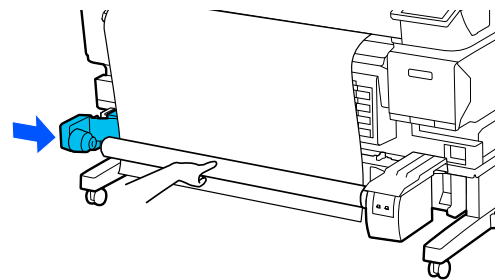

Basic Operations

! Important:

If the edges of the media are misaligned, the media cannot be taken up correctly. If the edges are misaligned, unlock the lock lever on the right-side roll core holder, and then start again from step 5.

- 9** Move the lock lever on the left-side roll core holder to the lock position to secure the roll core holder.

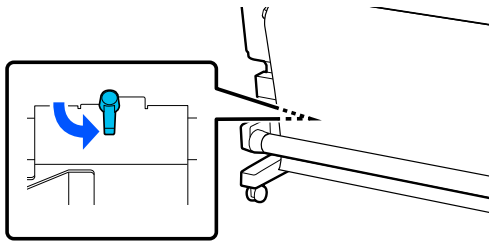

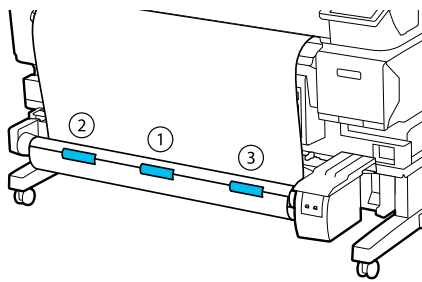

- 10** Check the winding direction, and then in the order shown in the illustration below, use commercially available tape to stick the media to the roll core. When attaching in the center, attach using tape while pulling the center of the media straight. When attaching to the left and right sides, attach using tape while pulling the media to the side.

Printed side in

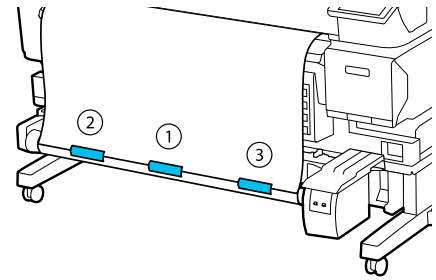

Printed side out



- 11** Press the  button until you have fed enough media for about one full wrap around the roll core.

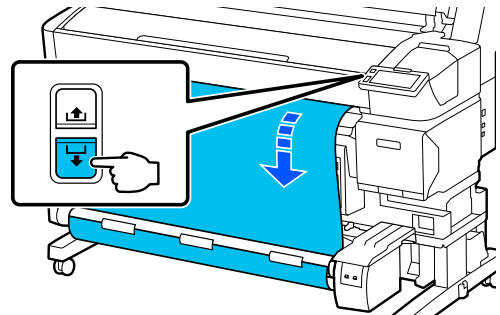

- 12** Set the Manual switch so that it matches the winding direction, and then wind the media once around the roll core.

Printed side in

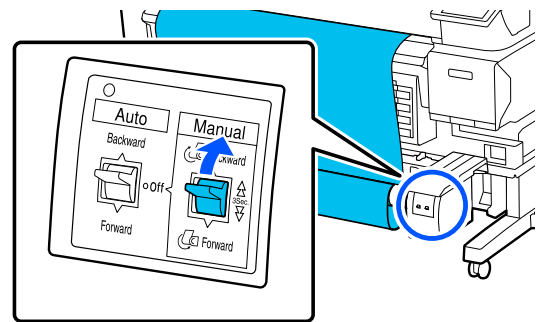

Printed side out

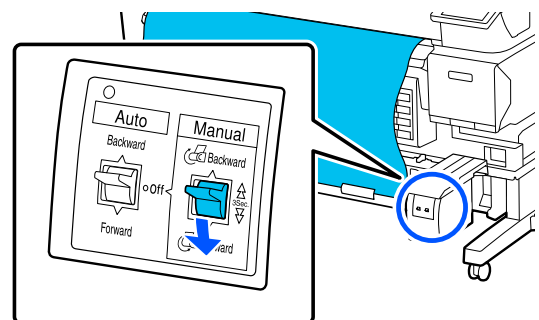

Basic Operations

- 13** Set the Auto switch so that it matches the winding direction.

Printed side in

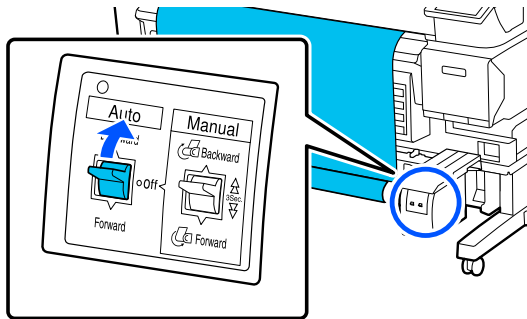

Printed side out

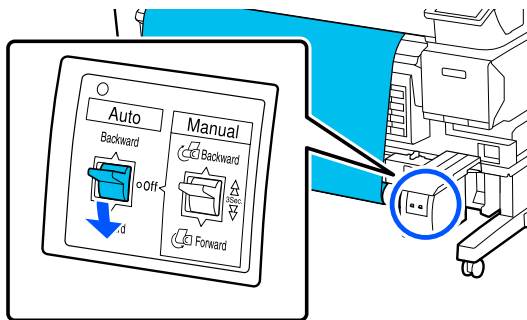

- 14** Confirm that the media is not loose.

Tap lightly on both ends of the media, and check if there is a difference in tension between the left and right sides.

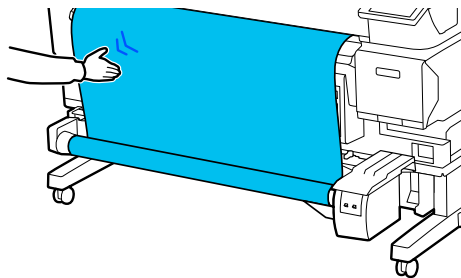

! Important:

If the tension on the left and right of the media is different, the media will not be taken up correctly. If there is slack on one side, rewind the media, peel off the tape, and then restart from Step 10.

Note:

If **Prepare for Take-up** is set to **On** in step 2 from "Settings for Loaded Media", the following screen is displayed after feeding the paper. Press **How To...** to load the media into the auto take-up reel unit while checking the procedure on the control panel.

After loading the media, press **Complete**.

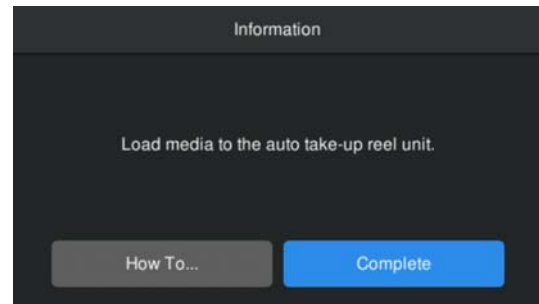

Printing

When **Ready to print.** is displayed on the screen, you can start printing.

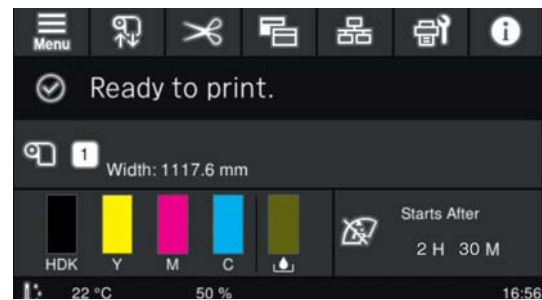

Removing Media

See the following if you are not using the auto take-up reel unit.

[👉 "Removing Media" on page 43](#)

If you are using the auto take-up reel unit, first cut the media, next remove the rewrapped media, and then remove the media from the printer.

[👉 "Cutting Media" on page 42](#)

[👉 "Removing the Take-up Roll" on page 42](#)



[👉 "Removing Media" on page 43](#)

Basic Operations

Cutting Media

When **Auto Cut** is set to **Off** or when media is loaded in the auto take-up reel unit, follow the steps below to cut the media after printing.

- 1 On the control panel screen, press . The Cut screen is displayed.

The cut is made at the dotted line shown in the illustration. To adjust the cutting position, while viewing the interior of the printer without opening the printer cover, press the  /  buttons to align the media to be cut with the  mark on the right side of the printer's interior.

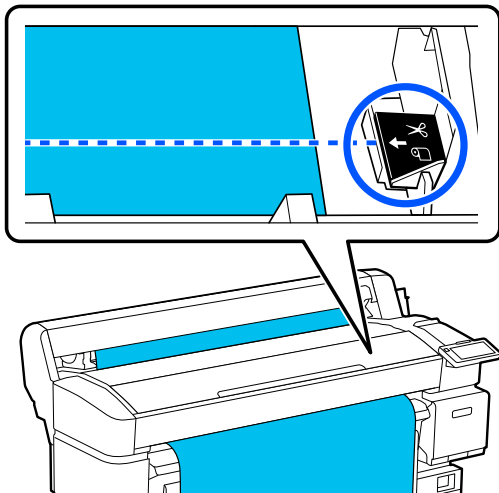

Note:

The minimum length of media that can be cut with the built-in cutter is fixed at 100 mm (3.94 in.) and cannot be changed.

If the cutting position is shorter than the length above, the media has to be automatically fed to a length at which it can be cut which will create a margin. Cut off the margin with a cutter sold at a store.

- 2 Support the media with your hand to prevent it from falling to the floor, and then press **Cut**. The media is cut.

Removing the Take-up Roll

This section describes how to remove media from the auto take-up reel unit.

 **Caution:**

Removing media from the auto take-up reel unit requires two workers, one on each end of the roll.

A single worker working alone could drop the media resulting in injury.

Cut the media if it has not been cut.

 [“Cutting Media” on page 42](#)

- 1 Set the Auto switch on the auto take-up reel unit to off.

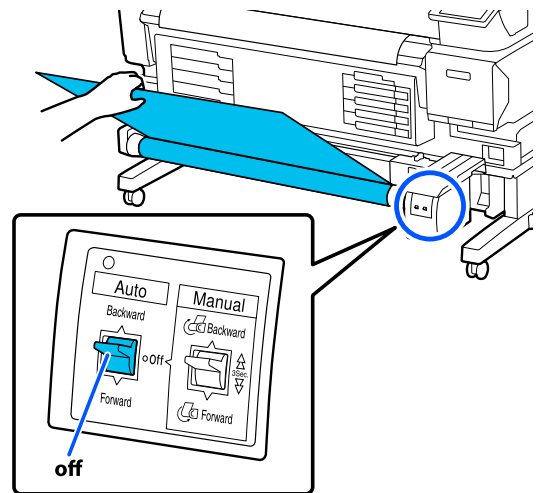

- 2 Set the Manual switch so that it matches the winding direction, and then wind the cut media.

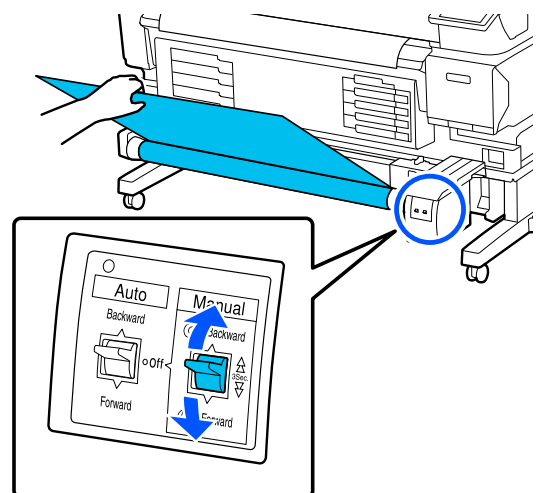

Basic Operations

- 3** Unlock the lock lever on the left-side roll core holder, and then remove the roll core holder from the roll core.

When removing the roll core holder, support the roll core with one hand to prevent it falling to the floor.

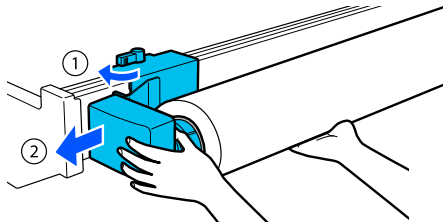

- 4** Remove the roll core from the auto take-up reel unit.

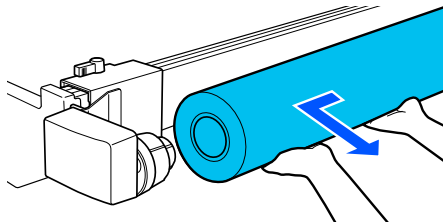

Removing Media

This section describes how to remove and store media after printing, such as when replacing media. The rollers may crease media left in the printer.

Cut the media if it has not been cut.

[“Cutting Media” on page 42](#)

- 1** Check that the printer is ready to print, and then press - **Start** on the control panel screen.

The media is rewound and ejected.

- 2** Open the media cover.

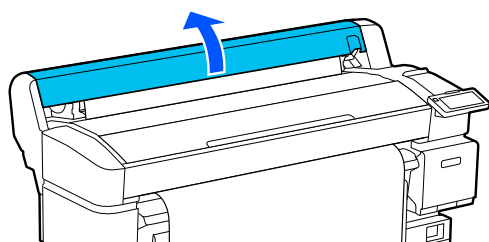

- 3** Raise the roll lock lever.

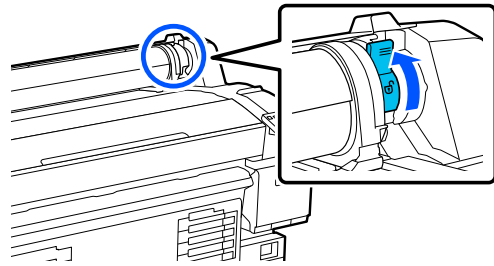

- 4** Holding the roll adapters on both sides, move the media to the roll rest.

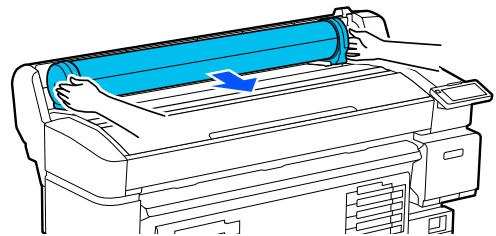

- 5** Raise the adapter lock levers to release the roll adapters.

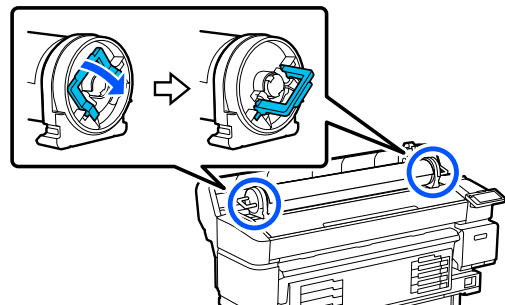

- 6** Remove the roll adapters.

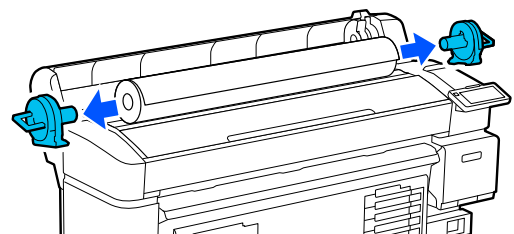

After rewinding the media carefully, store it in its original packaging.

Basic Operations

7

Close the media cover.

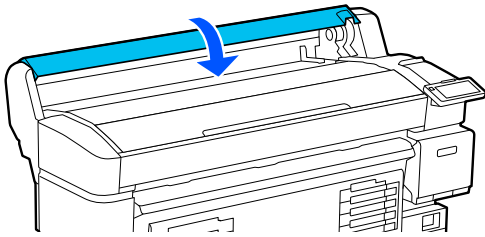

Optimizing Media Settings (Print Head Alignment and Media Feed Adjustment)

Perform this once before using the media settings registered to the printer.

Optimize the media settings (Print Adjustments) to correct individual differences in your media and printer so that you can perform optimal printing using your media and printer combination.

Optimize Media Settings in the following cases.

When media settings for downloaded EMX files are registered to the printer.

When changing Advanced Settings after saving Media Settings

To optimize Media Settings, load the media in the printer using the method you will use to actually print, and then perform Print Head Alignment and Media Feed Adjustment.

Make sure you perform Print Head Alignment and Media Feed Adjustment.

Print Head Alignment

This printer prints by firing drops of ink while moving the print head. There is a small distance (gap) between the media surface and the print head, and the printing position of the ink may become misaligned due to changes in the media thickness, temperature and humidity, the inertial force when the print head moves and so on.

You can use Print Head Alignment to adjust any misalignments in the printing position to improve misaligned ruled lines or graininess in the print outs.

Notes when performing Print Head Alignment

Adjustments are made according to the media loaded in the printer.

Make sure you select the name you set when you registered the media settings to this printer, or the name set in Media Management from the Settings menu in Select Media.

When printing on paper loaded in the take-up reel unit, perform Print Head Alignment in the same way as when printing with the media loaded in the take-up reel unit.

The minimum adjustable media width is 254 mm (10 in.)

Make sure nozzles are not clogged before adjusting.

If nozzles are clogged, adjustments will not be performed correctly. Print and visually inspect the check pattern, and then perform Head Cleaning if necessary.

 [“Print Head Nozzle Check” on page 64](#)

Procedure for Print Head Alignment

1

Check that the printer is ready to print, and load the media according to the actual usage conditions.

When using the auto take-up reel unit, attach the media to the take-up roll core.

 [“Loading Media” on page 36](#)

Basic Operations

 “Using the Auto Take-up Reel Unit (An Optional Item for the SC-F6400/SC-F6430/SC-F6440/SC-F6460)” on page 37

2 Press  (menu), and then press **Media Settings - Print Adjustments - Print Head Alignment**.

3 Press **Start**.
An adjustment pattern is printed. Wait until printing is complete.

4 Check the printed #1A adjustment pattern.

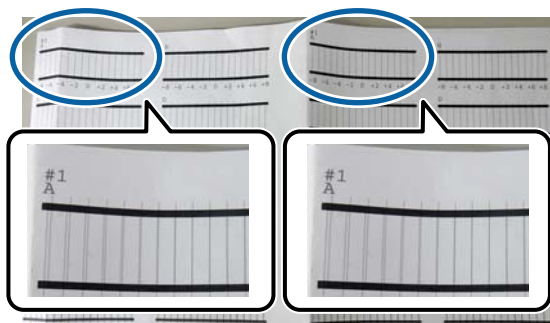

In the illustration above, #1A is in two locations, but the number printed depends on the media width.

5 Check the number of the pattern with the finest lines (the lines overlap). This would be pattern 0 in the example shown in the following illustration.

Check the number of the adjustment patterns with the finest lines in all #1 A patterns.

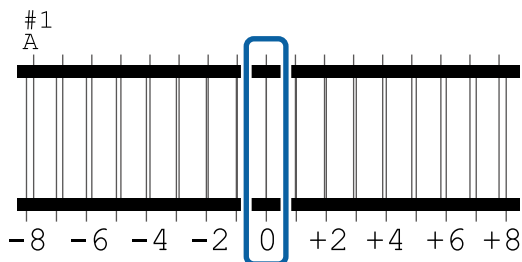

6 Find the average value for all #1A adjustment patterns.

Example: When two adjustment patterns have been printed

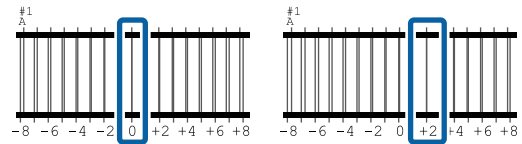



$$(0+2) / 2 = 1$$

Note:

If the value you get is not an integer, round it to the integer.

$$(1+2) / 2 = 1.5 \rightarrow 2$$

7 The screen for entering confirmation results for the adjustment pattern is displayed.

Press / to set the average value you obtained in step 6.

8 Repeat steps 5 to 7 for #1B, #2A, and #2B, and then press **OK**.

When adjustments are complete, the Home screen is displayed.

Media Feed Adjustment

This menu is also used when banding (horizontal banding, tint unevenness, or stripes) is detected in printing results.

You can select from **Manual(Standard)** or **Manual(Measurement)** to perform adjustments.

Manual (Standard)

Usually, select this option.

Manual (Measurement)

Select this option in the following cases.

Basic Operations

- ❑ When banding can be seen in the print results even after performing adjustments for Manual(Standard)
- ❑ When it is difficult to check the patterns for Manual(Standard) due to bleeding ink and so on
- ❑ When you want to print with accurate length

The approximate length of the media required to print the test pattern is given below.

When performing **Manual(Standard)**: Approx. 190 mm (7.48 in.)

When performing **Manual(Measurement)**: Approx. 1090 mm (42.9 in.)

Adjustment Procedure

- 1 Check that the printer is ready to print, and load the media according to the actual usage conditions.
 When using the auto take-up reel unit, attach the media to the take-up roll core.
 📖 [“Loading Media” on page 36](#)
 📖 [“Using the Auto Take-up Reel Unit \(An Optional Item for the SC-F6400/SC-F6430/SC-F6440/SC-F6460\)” on page 37](#)
- 2 Press  (menu), and then press **Media Settings - Print Adjustments - Media Feed Adjustment - Manual(Standard)** or **Manual(Measurement)**.
- 3 Press **Start**.
 An adjustment pattern is printed. Wait until printing is complete.

- 4 Check the printed adjustment pattern.
When Manual(Standard) is selected

Two groups of adjustment patterns, A and B, are printed. Select the pattern with the least amount of overlapping or gaps for each group. Select "0.0%" in the cases shown below.

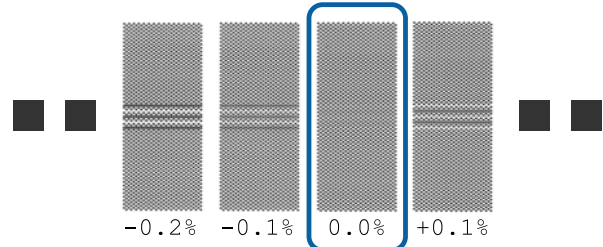

If there are patterns with the same overlapping or gaps, enter the middle value in step 6. Enter "-0.05%" in the cases shown below.

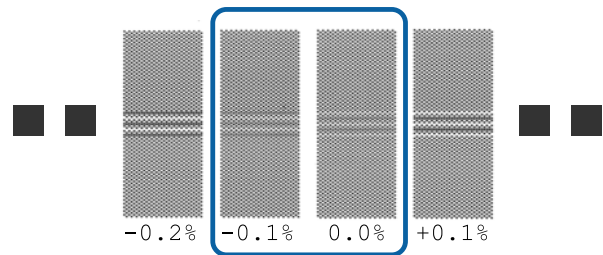

If all of the adjustment patterns contain overlapping or gaps, select the pattern with the least overlaps or gaps. Perform steps 2 to 4 again, and repeat them until a pattern with no overlapping lines or gaps is printed.

If the pattern is difficult to check, such as if the ink bleeds, input "0.0%" one time.

In this situation, the media feed is not adjusted. Perform the following steps to complete Manual(Standard), and then perform Manual(Measurement) again.

When Manual(Measurement) is selected

Adjustment patterns #1 and #2 are printed.

Cut after the adjustment pattern, spread it out on a flat surface, and then measure it using a scale.

Basic Operations

Use a scale that can measure in increments of at least 0.5 mm (0.02 in.). We also recommend using a scale that can measure at least 500 mm (20.0 in.).

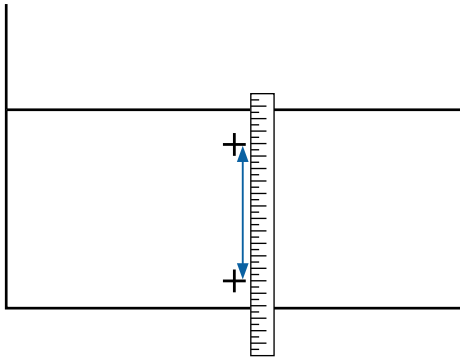

5 The screen for entering confirmation results for the adjustment pattern is displayed.

When Manual(Standard) is selected

Set the values printed under the patterns selected in A and B, and then press **OK**.

When Manual(Measurement) is selected

Set the values measured in step 4 for #1 and #2 respectively, and then press **OK**.

When adjustments are complete, the Home screen is displayed.

Adjusting the Amount of Media Fed While Printing

You can perform fine adjustments for the amount of media fed while printing. Adjusting while printing allows you to quickly check the adjustment results.

1 During printing, press the following area on the home screen (adjust while printing).

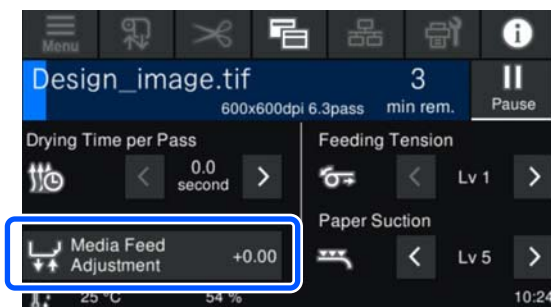

If the home screen (adjust while printing) is not displayed, press (switch screens) on the home screen.

2 Press / on the screen, or press the / buttons on the control panel to change the value.

If the feed amount is too small, black bands (dark stripes) appear; press the (or button) to adjust the feed amount upwards.

In contrast, if the feed amount is too large, white bands (pale stripes) appear; press the (or button) to adjust the feed amount downwards.

3 Check the printing result. If you are not satisfied with the results, use the / , or the / buttons on the control panel to change the value.

The setting for the currently selected registered media number is updated.

4 Press to return to the home screen.

Note:

The results of changing the settings are un-done if you perform any of the following operations.

- Restart **Media Feed Adjustment**.
- Execute **Clear All Data and Settings**.

When you have finished the target printing, we recommend performing **Print Adjustments** from the settings menu.

[“Optimizing Media Settings \(Print Head Alignment and Media Feed Adjustment\)”](#) on page 44

Basic Operations

Printable area

The gray area in the illustration below shows the printable area. The arrow indicates the feed direction.

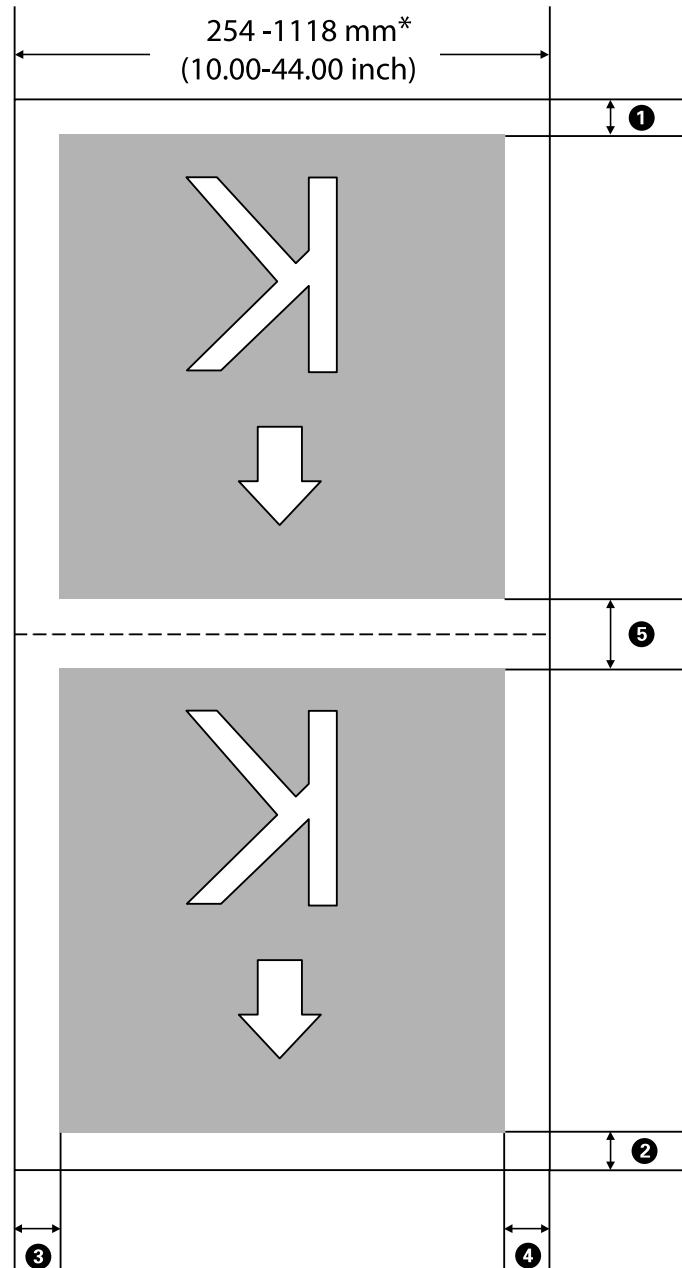

* When **Width Detection** is set to **Off**, the value you set is used.

 [“General Settings Menu” on page 71](#)

Basic Operations

See the following table for more details on ❶ to ❺.

Margin Position	Explanation	Available Setting Range
❶ Trailing edge ^{*1, *4, *5}	The value set in Bottom Margin from the printer's Printer Setup menu. Applied before automatic cutting after printing.	5 to 150 mm (0.20 to 5.91 in.)
❷ Leading edge ^{*1, *6}	The value set in Top Margin from the printer's Printer Setup menu. Applied before printing after loading media or cutting.	5 to 35 mm (0.20 to 1.38 in.)
❸ Right edge ^{*2, *3}	The value set in Right Margin from the printer's Printer Setup menu.	3 to 25 mm (0.12 to 0.98 in.)
❹ Left edge ^{*2, *3}	The value set in Left Margin from the printer's Printer Setup menu.	3 to 25 mm (0.12 to 0.98 in.)
❺ Between pages ^{*1, *4, *5}	The value set in Margin Between Pages from the printer's Printer Setup menu. Applied when printing continues without automatic cutting after printing (half of the value set for after printing and half for before printing).	5 to 999 mm (0.20 to 39.33 in.)

- *1 The set margin and the actual print results may differ depending on the RIP being used. Contact the RIP manufacturer for more information.
- *2 This may be available in the RIP depending on the RIP software being used. Contact the RIP manufacturer for more information.
- *3 If the total of the print data width and set left and right margins exceeds the printable area, a portion of the data will not be printed.
- *4 Automatic cutting may be available in the RIP depending on the RIP software being used. Contact the RIP manufacturer for more information. If the RIP does not have an automatic cutting setting, the printer's Auto Cut setting is applied.
- *5 When using the auto take-up reel unit (and the Auto switch is set to Forward/Backward), automatic cutting is not performed while printing.
- *6 The minimum top margin varies depending on the Pass Mode as shown in the following table.

SC-F6400 Series

Pass Mode	Minimum Top Margin
300x600dpi -1.1pass draft	8mm (0.31in.)
300x600dpi -1.1pass	8mm (0.31in.)
300x600dpi -1.5pass	16mm (0.63in.)
300x600dpi -2.3pass	24mm (0.94in.)
600x600dpi -2.1pass	5mm (0.2in.)
600x600dpi -3.0pass	5mm (0.2in.)
600x600dpi -4.0pass	5mm (0.2in.)

Basic Operations

Pass Mode	Minimum Top Margin
600x600dpi -4.0pass HD	5mm (0.2in.)
600x1200dpi -6.0pass	6mm (0.24in.)
600x1200dpi -6.0pass HD	6mm (0.24in.)
600x1200dpi -8.0pass	6mm (0.24in.)
600x1200dpi -8.0pass HD	6mm (0.24in.)

SC-F6400H Series

Pass Mode	Minimum Top Margin
300x600dpi -2.1pass	5mm (0.2in.)
300x600dpi -3.5pass	5mm (0.2in.)
600x600dpi -4.7pass	5mm (0.2in.)
600x600dpi -6.3pass	6mm (0.24in.)
600x600dpi -6.3pass HD	6mm (0.24in.)
600x600dpi -8.5pass	34mm (1.34in.)
600x600dpi -8.5pass HD	34mm (1.34in.)
600x1200dpi -12.9pass	6mm (0.24in.)
600x1200dpi -12.9pass HD	6mm (0.24in.)

Note:

When **Width Detection** is set to **Off**, make sure that the set value does not exceed the width of the loaded media. If the set value is larger than the media width, the printer may print beyond the left or right edges of the media. Ink used outside the edges of the media will stain the inside of the printer.

Maintenance

When to Perform Various Maintenance Operations

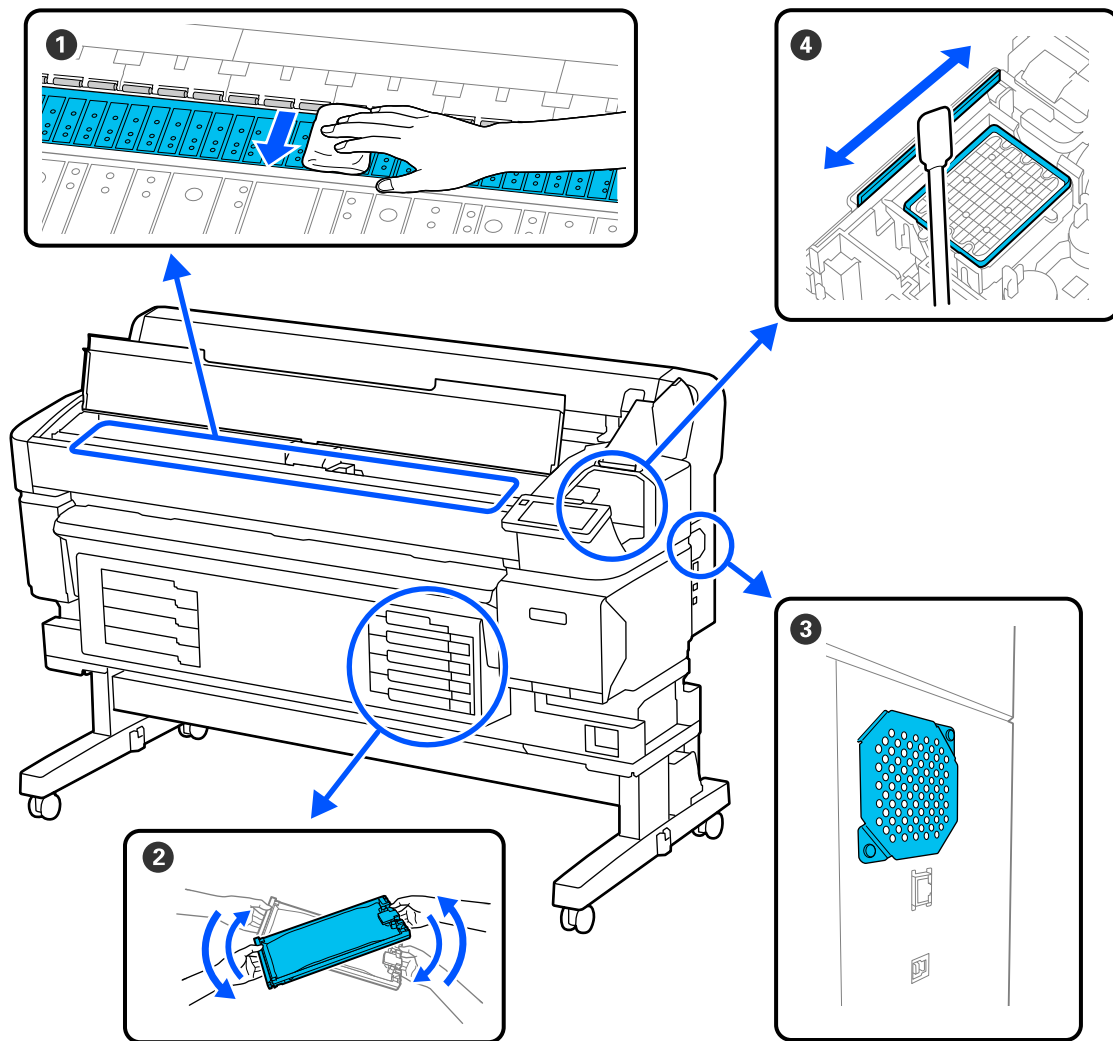

Regular Maintenance

If you continue to use the printer without cleaning, it could cause clogged nozzles, ink drops, or color changes in the print results to occur.



When to perform	Component to be cleaned
<p>At least once a month</p>	<p>1 Cleaning the platen</p> <p>🔗 "Cleaning the Platen" on page 57</p> <p>4 Cleaning the capping station and wiper</p> <p>You can check the procedure in a video on YouTube.</p> <p>🔗 "Cleaning the Capping Station and Wiper" on page 56</p>

Maintenance

When to perform	Component to be cleaned
Once a month or when dust is noticeable	<p>③ Cleaning the vent</p> <p> "Cleaning the Vent" on page 58</p>
<p>When a shake message is displayed on the control panel screen</p> <p>(Messages are displayed regularly)</p>	<p>② Shaking the ink</p> <p> "Shaking the Ink Supply Units Periodically" on page 58</p>

 **Important:**



The printer contains precision instruments. If any lint or dust adheres to the nozzles on the print head, print quality or media feeding quality will decline.

Perform regular cleaning more frequently depending on the environment and media being used.

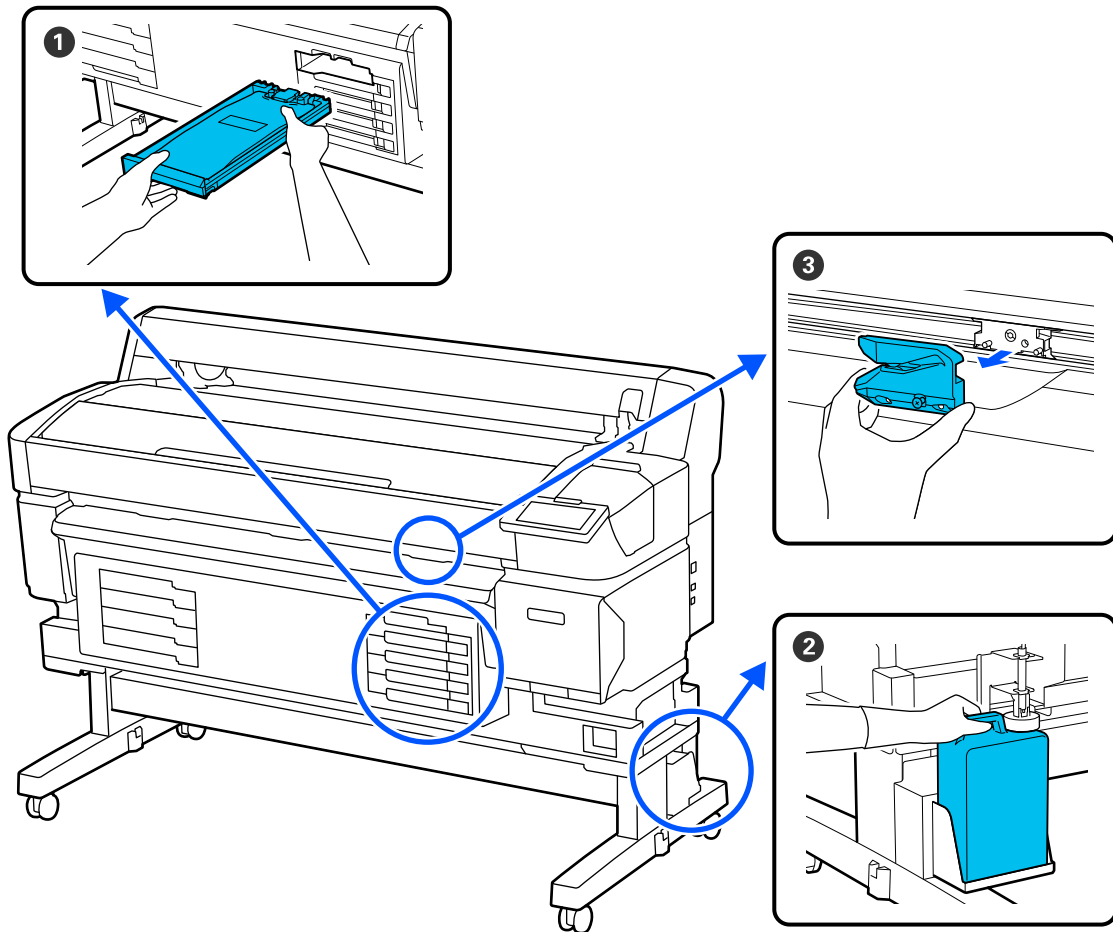
Refilling and Replacing Consumables



Maintenance

When to perform	Component to be replaced
When an error appears on the control panel screen indicating ink is expended	① Replacing ink supply units  "Replacing Ink Supply Units" on page 59
When a replacement message is displayed on the control panel	② Waste ink bottle  "Disposing of Waste Ink" on page 60
When the media is not cut neatly/Cut edges are frayed	③ Auto cutter blade  "Replacing the Auto Cutter Blade" on page 63

Maintenance

What You'll Need

Ready the following items before beginning cleaning and replacement.

When the supplied parts have been completely used, purchase new consumables. Prepare genuine parts when replacing ink supply units or performing maintenance.

 [“Options and Consumable Products” on page 94](#)

If your gloves have worn out, prepare commercially available nitrile gloves.

Protective eyeglasses (available in the market)

Protects your eyes from ink and ink cleaner.

Mask (available in the market)

Protects your nose and mouth from ink and ink cleaner.

Maintenance kit (supplied with the printer)

Use for cleaning the capping station and wiper.

The following items are in the kit.

When the supplied parts have been completely used, purchase new consumables.

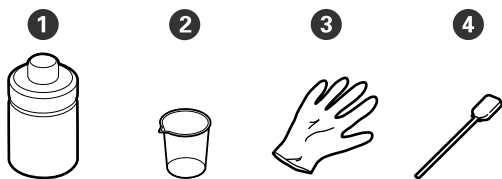

- ① Ink cleaner (x1)
- ② Cup (x1)
- ③ Gloves (x12)
- ④ Cleaning sticks (x25)

Head maintenance kit (supplied with the printer)

Use this to clean the print head.

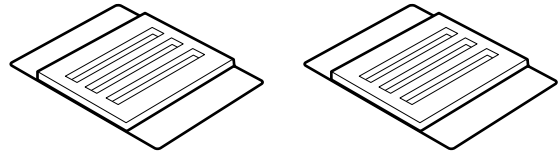

Metal or plastic (PP/PE) tray (available in the market)

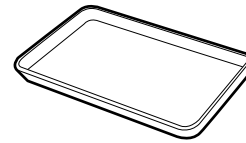

Use this to place cleaning utensils, removed consumables, or ink cleaner moved in the cup supplied with the printer.

Soft cloth (available in the market)

Use for cleaning the platen. Use material that is not likely to generate lint or static electricity.

Precautions Regarding Maintenance

Note the following points when cleaning and replacing parts.

Maintenance

**Caution:**

- ❑ *During maintenance, wear protective clothing, including protective eyewear, gloves, and a mask.*

Should ink, waste ink, or ink cleaner come into contact with your skin or enter your eyes or mouth, take the following actions:

- ❑ *If fluid adheres to your skin, wash it off using large volumes of soapy water. If you notice any reaction developing in the affected area, consult with a qualified physician immediately.*

- ❑ *If ink gets into your eyes, wash them out immediately with water. Failure to observe this precaution could result in bloodshot eyes or mild inflammation. Consult with a qualified physician if any other problems should develop.*

- ❑ *If fluid enters your mouth, consult with a physician as soon as possible.*

- ❑ *If swallowed, do not induce vomiting. Consult with a physician as soon as possible. If vomiting is induced, vomited material may enter the windpipe, which is dangerous.*

- ❑ *Store ink supply units, waste ink, and ink cleaner in a location out of reach of children.*

- ❑ Remove the media from the printer before proceeding.
- ❑ Never touch the belts, circuit boards, or any parts that do not require cleaning. Failure to observe this precaution could result in malfunction or reduced print quality.
- ❑ Do not use anything other than the supplied or consumable cleaning stick. Other types of stick that produce lint will damage the print head.
- ❑ Always use fresh cleaning sticks. Re-using sticks can make stains even harder to remove.
- ❑ Do not touch the tips of the cleaning sticks. Oil from your hands could damage the print head.
- ❑ Do not use anything other than the ink cleaner specified to clean the capping station or the wiper. Using anything else could result in malfunction or reduced print quality.

- ❑ Touch a metallic object before starting work to discharge any static electricity.

Maintenance

Performing Regular Maintenance

Cleaning the Capping Station and Wiper

Clean the capping station once a month. You may need to clean more frequently depending on the environment and media being used.

Read the following before starting this procedure.

 [“Precautions Regarding Maintenance” on page 54](#)

- 1** Press  on the screen, and then press **Cleaning the Maintenance Parts - Capping Station/Wiper**.
- 2** Press **Next - Start**.
The print head moves to the cleaning position.
- 3** Open the maintenance cover.

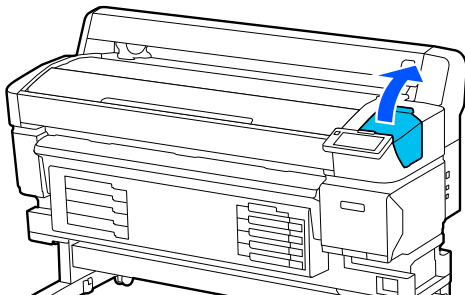

- 4** Pour the ink cleaner into the cup up to the first line on the cup.
We recommend working on a tray or a similar surface to avoid contaminating the surrounding area.

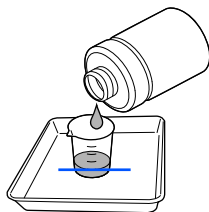

- 5** Dampen the cleaning stick with ink cleaner.
Do not allow the liquid to drip from the cleaning stick.

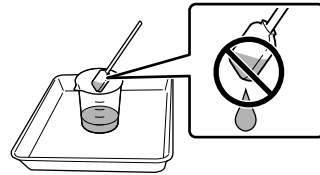

- 6** Use the cleaning stick to wipe away any ink or lint from the edges of the capping station.
Wipe the three areas shown in the illustrations below.

Outer edges

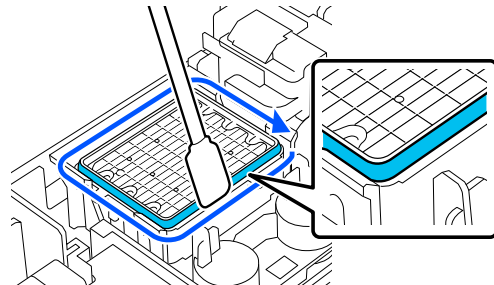

Top edges

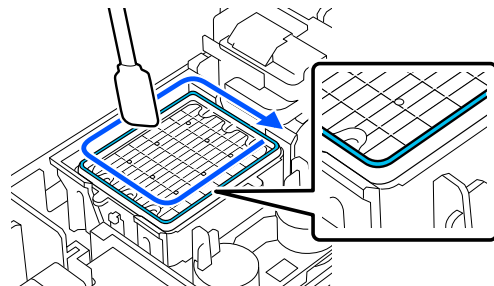

Inner edges

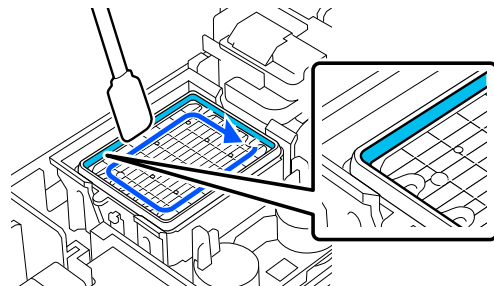

Maintenance

- 7** Use the cleaning stick to wipe away any ink or lint from the part of the wiper shown in the illustration.

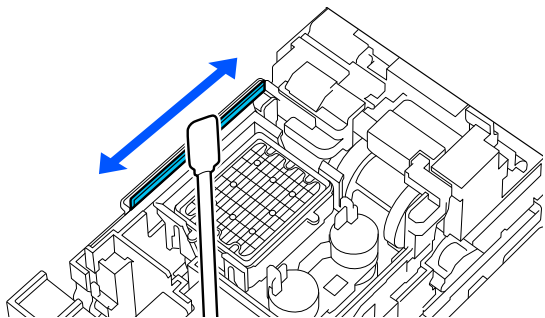

- 8** Close the maintenance cover, and then press **Done**.

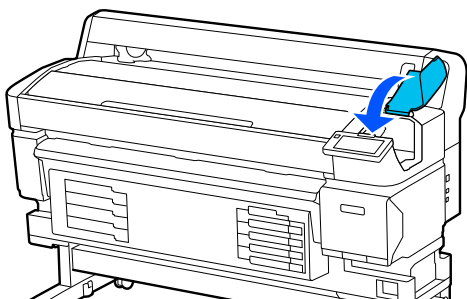

Cleaning the Platen

The platen becomes dirty when paper particles or ink stick to it. We recommend cleaning the platen once a month because the media will become dirty if there is ink stuck to the platen.

You may need to clean more frequently depending on the environment and media being used.

Read the following before starting this procedure.

[“Precautions Regarding Maintenance” on page 54](#)

- 1** After removing the media, make sure the printer is turned off and the screen has turned off, and then unplug the power cable from the outlet.
- 2** Wait for one minute after unplugging the power plug.

- 3** Open the printer cover and use a soft, clean cloth to carefully clean away any dust or dirt inside the printer.

Carefully wipe the platen. To avoid spreading the dirt, wipe from the inside to the outside. If there is a serious dirt problem, clean it using a soft, clean cloth dampened with a mild detergent. Then, wipe the inside of the printer with a dry, soft cloth.

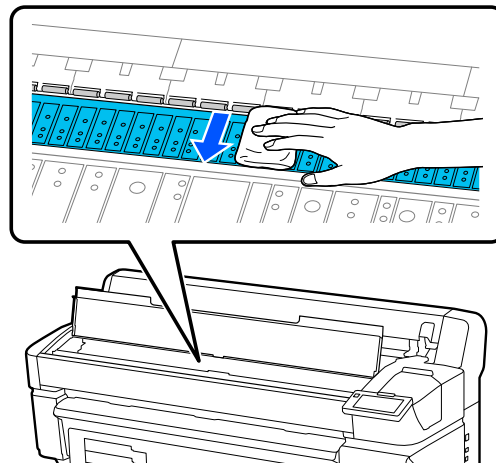

! Important:
Be careful not to touch the ink tubes inside the printer, otherwise, the printer may be damaged.

- 4** If any paper particles (that looks like white powder) accumulates on the platen, use something like a cocktail stick to push it in.

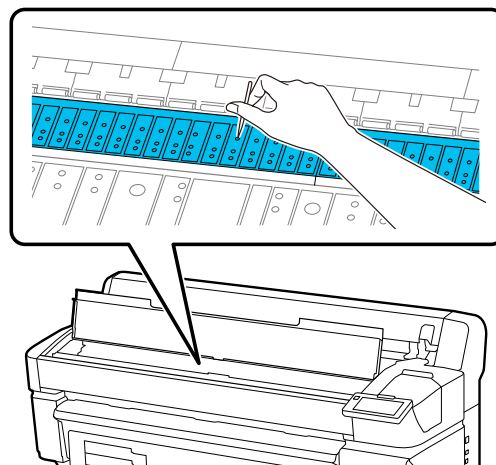



- 5** When you have finished cleaning, close the printer cover.

Maintenance

The printable surface is still dirty even after cleaning the platen

Follow the steps below to clean the roller by feeding and ejecting media.

- 1 Turn on the printer, and load it with widest available media.
 ↗ “Loading Media” on page 36
- 2 Press the  button.
 The media is fed while the  button is pressed. If the media is not soiled, cleaning is complete.

Cut the media after cleaning is done.

↗ “Cutting Media” on page 42

Cleaning the Vent

Clean the vent once a month or when dust is noticeable. Use a vacuum cleaner to remove dust from the vent.

Important:

If the vent is not cleaned, the temperature inside the printer may rise causing an error which may stop the printer from operating.

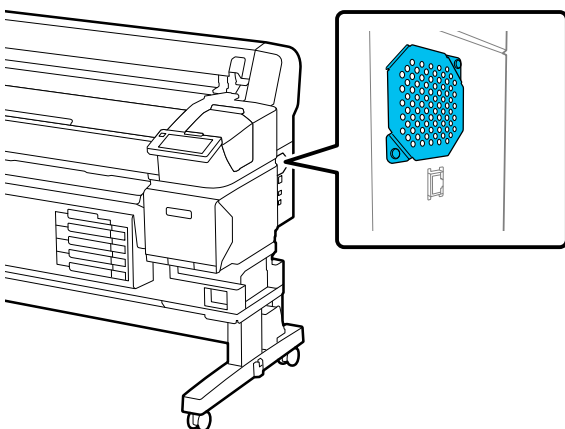

Shaking the Ink Supply Units Periodically

If a message is displayed informing you that it is time to shake the ink, remove the ink supply unit immediately and shake it.

Important:

Due to characteristics of the ink supply units and the ink used in this printer, it is prone to gradual sedimentation (components settling to the bottom of the liquid). If ink settles, tint unevenness and nozzle clogs occur. Shake ink supply units periodically after installing them.

After installing an ink supply unit in the printer, a message prompting you to shake the unit is displayed at the following intervals.

- High Density Black Ink: Once every week
- Other inks: Once every three weeks

Precautions When Shaking

- When shaking the ink supply unit, set it in the ink supply unit tray and shake it up and down at an angle of about 60 degrees 5 times in 5 seconds as shown in the following illustration.

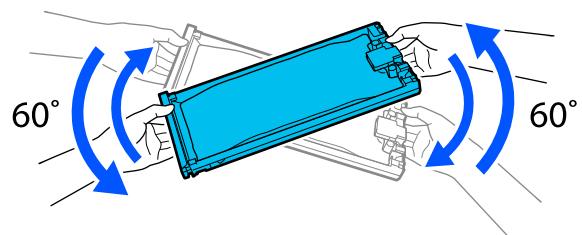

- Do not forcefully shake or swing ink supply units or ink supply unit trays containing ink supply units. Ink could leak.

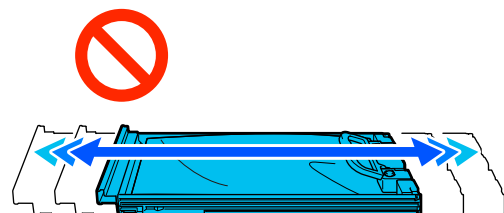

Maintenance

- Removed ink supply units may have ink around the ink supply port, so be careful not to get any ink on the surrounding area when removing the ink supply units.

Shaking

If a message is displayed informing you that it is time to shake the ink, you can check the procedure on the control panel while shaking the ink supply unit.

- 1 On the screen, press the status of consumables area.

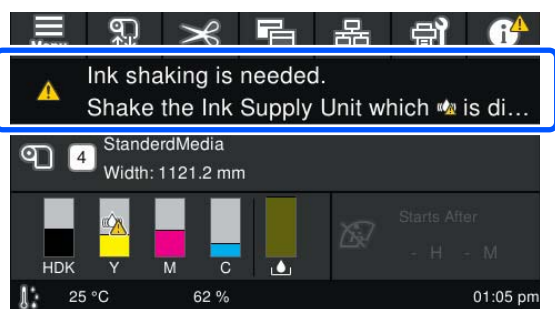

- 2 In the **Message List**, press the message informing you that it is time to shake the ink.

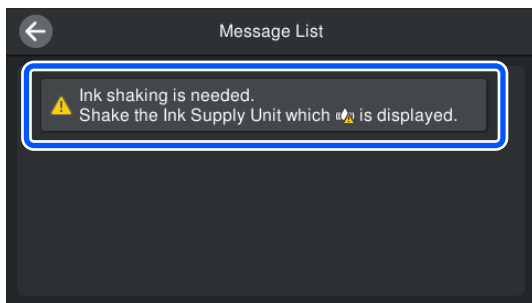

- 3 Press **How To...** to view the procedure. Follow the on-screen instructions to perform the procedure.

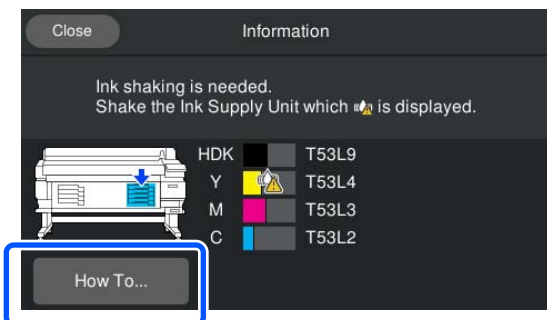

Replacing Ink Supply Units

Precautions When Replacing

! Important:

Epson recommends the use of genuine Epson Ink Supply Unit. Epson cannot guarantee the quality or reliability of non-genuine ink. The use of non-genuine ink may cause damage that is not covered by Epson's warranties, and under certain circumstances, may cause erratic printer behavior. Information about non-genuine ink levels may not be displayed, and use of non-genuine ink is recorded for possible use in service support.

- ❑ If one of the installed ink supply units is expended, printing cannot be performed. If ink is expended while printing, you can continue printing after replacing the ink supply unit. If you continue to use an ink supply unit that is running low, you may need to replace the ink supply unit while printing. If you replace it while printing, colors may look different depending on how the ink dries. If you want to avoid issues such as this, we recommend replacing the ink supply unit before printing. You can still use the removed ink supply unit in the future until the ink supply unit is expended.
- ❑ Insert all of the ink supply units into the ink supply unit trays. Printing is not possible or a malfunction may occur if even one of the ink supply unit trays does not contain an ink supply unit.
- ❑ When shaking the ink supply unit, set it in the ink supply unit tray and shake it up and down at an angle of about 60 degrees 10 times in 10 seconds as shown in the following illustration.

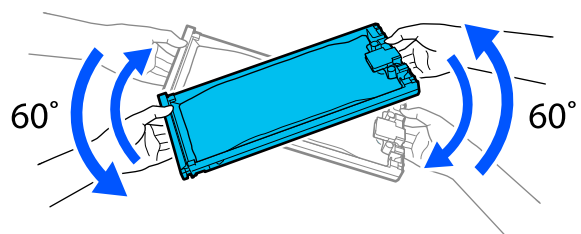

Maintenance

- ❑ When media is attached to the auto take-up reel unit, cut the media before replacing the ink supply unit.
🔗 “Cutting Media” on page 42
- ❑ You may not be able to use the built-in cutter if you replace the ink supply unit while the printer is being turned on. Cut the media with commercially available scissors.

Note:

Ink supply units contain components to help maintain print quality. These components are not foreign bodies.

Replacement Procedure

When a message prompting you to replace an ink supply unit is displayed

Press **How To...** You can check the procedure on the control panel while replacing the ink supply unit.

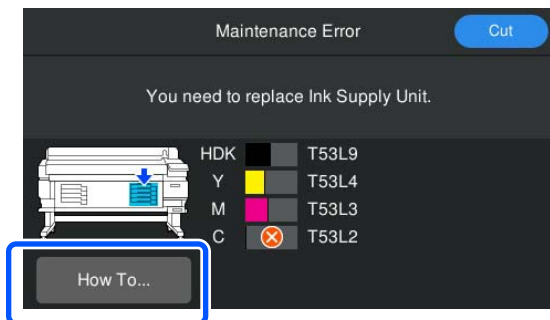

When you need to replace an ink supply unit because the amount of ink remaining is too low for the print job

- 1 Move the lock switch for the color you want to replace to unlock it.

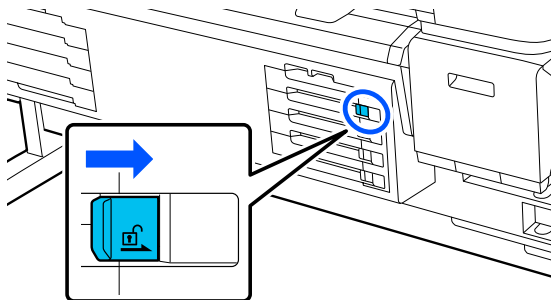

- 2 Press **How To...** on the control panel screen to view the procedure.

Follow the on-screen instructions to perform the procedure.

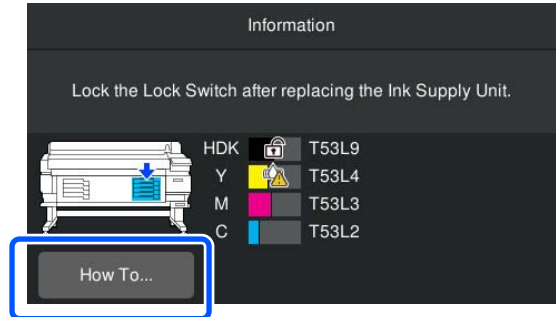

Disposing of Waste Ink

Precautions When Replacing the Waste Ink Bottle

- ❑ Be sure to confirm that the waste ink tube is inserted in the mouth of the waste ink bottle. Check that the stopper is stuck close to the mouth of the bottle. If there is a gap, waste ink may splatter and stain the surrounding area.

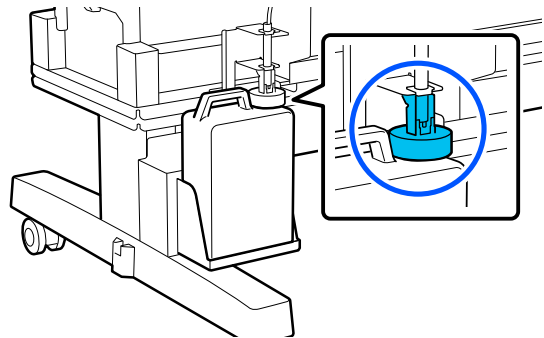

- ❑ You will need the lid for the Waste Ink Bottle when disposing of waste ink. Keep the lid in a safe place; do not throw it out.
- ❑ Unless you are prompted to do so by on-screen instructions, never remove the waste ink bottle while printing or while performing Head Cleaning. Waste ink may leak.

Maintenance

Replacing the Waste Ink Bottle

There are two methods for replacing the waste ink bottle as described below. Use the appropriate replacement method to suit your situation.

Read the following before starting this procedure.

 [“Precautions Regarding Maintenance” on page 54](#)

When a message is displayed indicating it is time to replace the waste ink bottle

Replace the waste ink bottle with a new bottle immediately.

When a message is displayed, press **How To...** You can check the procedure on the control panel while replacing the waste ink bottle.

Important:

*When the message **Waste Ink Bottle is nearing end of its service life.** is displayed, prepare a new waste ink bottle as soon as possible.*

See the following when replacing the waste ink bottle at this stage in the procedure.

 [“When you want to replace it at any time” on page 61](#)

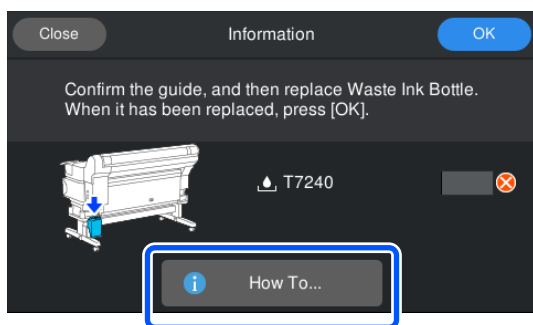

When you want to replace it at any time

When you want to replace the waste ink bottle due to night operations and so on before the message is displayed indicating that it is time to replace the bottle, follow the steps below to replace the waste ink bottle. If you do not follow the steps below, you will not receive a message at the correct replacement interval next time.

- 1 Press  on the screen, and then press **Replace Waste Ink Bottle**.
- 2 Press **How To...** to view the procedure.
Follow the on-screen instructions to perform the procedure.

Maintenance

Print Head Maintenance

If ink continues to drip onto the print results even after performing Head Cleaning several times, use the head maintenance kit to clean the print head.

Prepare the following items before beginning.

Read the following before starting this procedure.

 "Precautions Regarding Maintenance" on page 54

1 Press  on the screen, and then press **Cleaning the Maintenance Parts - Print Head**.
The Maintenance menu is displayed.

2 Press **Next - Start**.
The print head moves.

3 Open the printer cover.

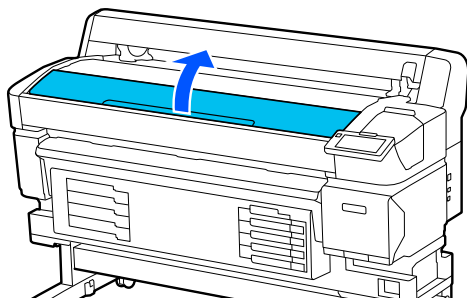

4 Remove the backing from the two head maintenance kits.

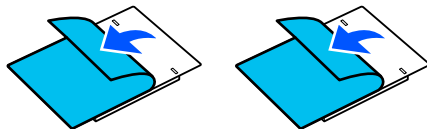

5 Attach the head maintenance kits to either side of the print head.

Placement position

Place them slightly away from the print head as shown in the illustration.

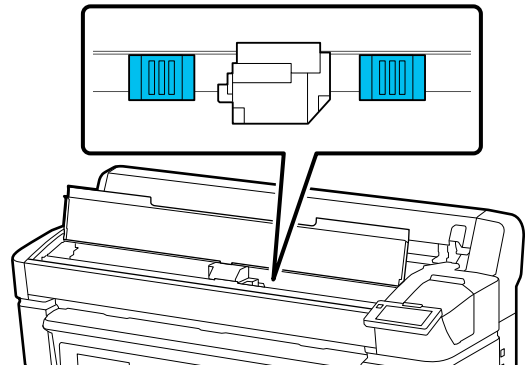

Placement method

Place the head maintenance kits by applying the edge of the kits to the roller.

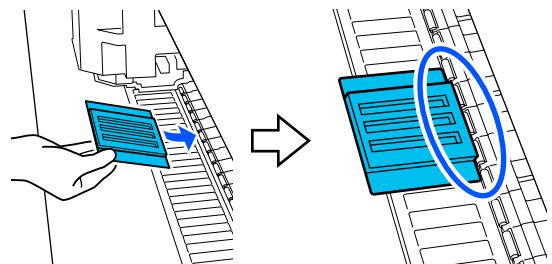

Important:

- Place the head maintenance kits so that there are no gaps between the kits and the roller. Cleaning will not be performed correctly if the kits are not placed properly.
- Do not move the print head by hand. This can cause damage.

Maintenance

- 6 Rub your finger over the areas indicated in the illustration to secure the head maintenance kits in place.

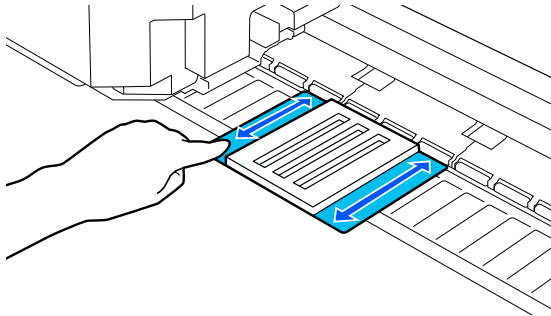

! Important:
Secure the adhesive parts of the head maintenance kits so that there are no parts that have not been stuck down. Do not press the cleaning pad too hard at this point. This could deform the platen.

- 7 Close the printer cover, and then press **Continue**.
Print head maintenance starts.

! Important:
Do not open the printer cover while cleaning. Cleaning stops if the cover is opened.

- 8 When a message prompting you to remove the head maintenance kit is displayed on the control panel screen, open the printer cover.

- 9 Remove the two head maintenance kits.

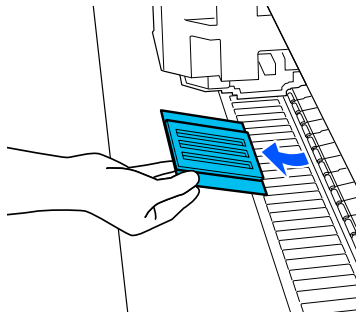

! Important:

- Remove them carefully so that no dirt gets on the surrounding area.
- Check the platen and clean it if it is dusty or dirty.
☞ "Cleaning the Platen" on page 57

Do not reuse a head maintenance kit.

☞ "Handling Used Consumables" on page 64

- 10 Close the printer cover, and then press **Done**.
Head Cleaning starts. When the procedure is complete, Head Cleaning is finished.

Replacing the Auto Cutter Blade

Replace the auto cutter blade if the media is not cut cleanly or if the edges of the cut sections are fluffy.

Supported auto cutter blade

☞ "Options and Consumable Products" on page 94

! Caution:
Do not store the auto cutter blade within the reach of children. The blade of the auto cutter blade could cause an injury. Pay careful attention when replacing the auto cutter blade.

Use a cross-head screwdriver to replace the auto cutter blade. Make sure you have a cross-head screwdriver with you before replacing the cutter.

Replacement Procedure

You can check the procedure on the control panel while working.

- 1 Press on the screen, and then press **Replace Auto cutter blade**.

Maintenance

- 2 Press **Start**, and then press **How To...** to view the procedure.

Follow the on-screen instructions to perform the procedure.

Note:

Place the used auto cutter blade in a bag or other suitable container, and dispose of it in accordance with local ordinances and municipal laws.

Precautions when Replacing the Auto Cutter Blade

- Take care not to damage the cutter blade. Dropping it or knocking it against hard objects may chip the blade.
- The sheet for the auto cutter blade is to protect the blade. Do not remove the sheet while replacing the auto cutter blade. After replacing the auto cutter blade, it will come off when the auto cutter blade returns to its original position.
- Tighten the screws locking the auto cutter blade firmly. If the auto cutter blade is not securely fastened, the cutting position may shift or be at the wrong angle.

Handling Used Consumables

The following used parts with adhered ink are classified as industrial waste.



- Cleaning stick
- Ink cleaner
- Ink supply units
- Waste ink
- Waste Ink Bottle
- Head Maintenance Kit
- Media after printing

Dispose of items according to local laws and regulations. For example, contract an industrial waste disposal company for disposal. In such cases, submit the "Safety data sheet" to the industrial waste disposal company.

You can download it at your local Epson Web site.

Print Head Nozzle Check

If you want to check the condition of the nozzles before printing, or if you see stripes or unevenness in the print results, you can print out a check pattern and visually check it to see the condition of the nozzles.

- 1 Check that the printer is ready to print, press , and then press **Print Head Nozzle Check**.
- 2 Press **Start**.
The check pattern is printed.
- 3 Check the check pattern.
If necessary, press the  button to feed the media so that you can check it.

Example of clean nozzles

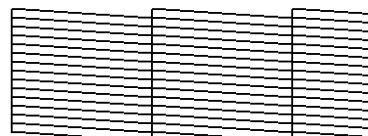

If there are no gaps in the check pattern, press [O].

Example of clogged nozzles



If there are gaps in the nozzle check pattern, press [X], and then perform Head Cleaning.

 ["Head Cleaning" on page 65](#)

Head Cleaning

Types of Cleaning

The following four types of Head Cleaning are available.

Auto Cleaning

The level is automatically changed, according to the condition of the clog detected in a nozzle, and then cleaning is done.

See the following for details on how to perform cleaning.

 [“Performing Head Cleaning” on page 65](#)

Perform Head Cleaning as necessary

If there are gaps in the nozzle check pattern, or if there are streaks in the print results, the colors are wrong, or there are ink drops, perform Head Cleaning.

When Head Cleaning is complete, print the nozzle check pattern again to check the condition of the nozzles.

See the following for details on how to perform Head Cleaning.

 [“Performing Head Cleaning” on page 65](#)

Perform Head Cleaning periodically

In Maintenance Setting, set Periodic Cleaning to On to perform periodic Head Cleaning as a preventative measure before clogs actually occur in the nozzles. Set Print Duration, Print Counter, or Print Length as the interval.

 [“General Settings Menu” on page 71](#)

Set Maintenance Cleaning

In **Maintenance Setting**, set **Maintenance Cleaning** to **On** to perform Head Cleaning automatically after a set period of time has passed, to keep the print head in good condition.

 [“General Settings Menu” on page 71](#)

Performing Head Cleaning

Perform Auto Cleaning first. If this does not clear the clogs, perform in the order of **Cleaning (Light)** and then **Cleaning (Heavy)** until the clogs are cleared.

1 Check that the printer is ready to print, press , and then press **Head Cleaning**.

2 Select a cleaning method.
Select **Auto Cleaning** first.
Next, select **Cleaning (Light)**.
And finally, select **Cleaning (Heavy)**.

3 Head Cleaning starts.
A cleaning result message is displayed when Head Cleaning is complete.

4 Check the message, and then click **OK**.
If clogging is cleared
Continue with normal operations.

If nozzles are still clogged

Go back to step 1, and then perform **Cleaning (Light)**. If nozzles are still clogged even after performing **Cleaning (Light)**, perform **Cleaning (Heavy)**.

If nozzles are still clogged even after performing Cleaning (Heavy)

The printer requires internal cleaning.

Perform the following according to the status of print results.

When horizontal lines appear or the colors are wrong

 [“Cleaning the Capping Station and Wiper” on page 56](#)

If ink drops occur

 [“Print Head Maintenance” on page 62](#)

Control Panel Menu

Control Panel Menu

Menu List

The following items and parameters can be set and executed in the Menu. See the reference pages for more details on each item.

General Settings

For more information on these items, see [🔗 “General Settings Menu” on page 71](#)

Item	Parameter
Basic Settings	
LCD Brightness	1 to 9
Sounds	
Button Press	0, 1, 2, 3
Completion Notice	0, 1, 2, 3
Warning Notice	
Volume	0, 1, 2, 3
Repeat	Off, Until Stopped
Error Tone	
Volume	0, 1, 2, 3
Repeat	Off, Until Stopped
Sound Type	Pattern1, Pattern2
Alert Lamp Notice	On, Off
Sleep Timer	1 to 240
Wake from Sleep	
Touch LCD Screen to Wake	On, Off, Scheduled
Date/Time Settings	
Date/Time	
Daylight Saving Time	Off, On (Winter, Summer)*
Time Difference	-12:45 to +13:45

Control Panel Menu

Item	Parameter
Language	Japanese, English, French, Italian, German, Portuguese, Spanish, Dutch, Russian, Korean, Traditional Chinese, Simplified Chinese, Thai, Indonesian, Turkish
Background Color	Gray, Black, White
Keyboard	QWERTY, AZERTY, QWERTZ
Unit Settings	
Length Unit	m, ft/in
Temperature	°C, °F
Printer Setup	
Margins	
Right Margin	3 to 25 mm (0.12 to 0.98 inch)
Left Margin	3 to 25 mm (0.12 to 0.98 inch)
Margin Between Pages	5 to 999 mm (0.20 to 39.33 inch)
Top Margin	5 to 35 mm (0.20 to 1.38 inch)
Bottom Margin	5 to 150 mm (0.20 to 5.91 inch)
Media Detection	
Width Detection	On, Off
Media Width	254.0 to 1117.6 mm (10.00 to 44.00 inch)
Detect Paper Skew	On, Off
Nozzle Check between Pages	
On	
Execution Timing	
Print Length	1 to 9999 m (3.28 to 32805.12 ft)
Print Page	1 to 9999 pages
Print Duration	1 to 9999 minutes
Off	
Information Printing	
Media Remaining Information	On, Off
Print Information	On, Off
Cut Settings	
Auto Cut	On, Off
Restore Default Settings	Network Settings, Clear All Data and Settings

Control Panel Menu

Item	Parameter
Maintenance Setting	
Cleaning Setting	
Threshold of Clogged Nozzles	1 to 10
Max Retry Cleaning Count	0, 1, 2
Periodic Cleaning	
On	
Execution Timing	
Print Duration	1 to 9999 minutes
Print Page	1 to 9999 pages
Print Length	1 to 9999 m (3.28 to 32805.12 ft)
Cleaning Level	Light, Heavy
Off	
Actions Beyond Threshold of Missing Nozzles	Stop Printing, Show Alert, Auto Cleaning
Maintenance Cleaning	On, Off
Network Settings	
Network Status	Wired LAN Status, Print Status Sheet
Advanced	
Device Name	
TCP/IP	Auto, Manual
Proxy Server	Do Not Use, Use
IPv6 Address	Enable, Disable
Link Speed & Duplex	Auto, 100BASE-TX Auto, 10BASE-T Half Duplex, 10BASE-T Full Duplex, 100BASE-TX Half Duplex, 100BASE-TX Full Duplex
Redirect HTTP to HTTPS	Enable, Disable
Disable IPsec/IP Filtering	
Disable IEEE802.1X	

*Only displayed for the SC-F6470/ SC-F6470H.

Media Settings

For more information on these items, see  [“Media Settings Menu” on page 78](#)

Item	Parameter
Current Settings	

Control Panel Menu

Item	Parameter
Media	01 XXXXXXXXXXX to 10 XXXXXXXXXXX
Media Type	
Media Width	
Advanced Settings	
Print Adjustments	
Media Feed Adjustment	Manual(Standard), Manual(Measurement)
Print Head Alignment	
Media Management	
01 XXXXXXXXXXX to 10 XXXXXXXXXXX	
Change Name	
Media Type	Thin 50g/m2, Med-Thick 70g/m2, Thick 120g/m2
Advanced Settings	
Drying Time	
Drying Time per Pass	0.0 to 10.0 Secs
Drying Time per Page	0.0 to 60.0 minutes
Platen Gap	1.6, 2.0, 2.5
Feeding Tension	Lv1 to Lv5
Paper Suction	Lv0 to Lv6
Skew Reduction	On, Off
Stick Prevention	On, Off
Rewind Tension*	Lv1 to Lv6
Reduce Print Streak	Off, Light, Medium, Heavy
Remaining Amount Management	
Remaining Amount Management	On, Off
Remaining Amount	1.0 to 9999.9 m (3.3 to 32808.1 ft)
Remaining Alert	1.0 to 999.5 m (3.3 to 3279.2 ft)
Print Length Management	
Auto Reset	Off, After Last Page
Manual Reset	

*Displayed when the auto take-up reel unit is installed.

Control Panel Menu

Maintenance

For more information on these items, see [“Maintenance Menu” on page 82](#)

Item	Parameter
Print Head Nozzle Check	
Head Cleaning	Auto Cleaning, Cleaning (Light), Cleaning (Heavy)
Cleaning the Maintenance Parts	Print Head, Capping Station/Wiper
Replace Waste Ink Bottle	
Replace Auto cutter blade	

Supply Status

Details on menu [“Supply Status Menu” on page 82](#)

Replacement Part Information

Details on menu [“Replacement Part Information Menu” on page 83](#)

Printer Status

Details on menu [“Printer Status Menu” on page 83](#)

Item	Parameter
Firmware Version	Printer, Auto Take-up Reel Unit
Printer Name	
Fatal Error Log	
Operation Report	Total Print Area, Total Media Feed Length, Total Carriage Pass
Auto Take-up Reel Unit	

Control Panel Menu

Details of the Menu

General Settings Menu

* indicates default settings.

Item	Parameter	Explanation
Basic Settings		
LCD Brightness	1 to 9 (9*)	Adjusts the brightness of the control panel display.
Sounds		
Button Press	0	Sets the volume of the sounds when the power button and control panel screen are operated.
	1*	
	2	
	3	
Completion Notice	0	Sets the volume of the sounds when print jobs or maintenance operations are finished.
	1	
	2	
	3*	
Warning Notice		
Volume	0	Sets the volume and the repetitions of sounds when it is time to replace consumables.
	1	
	2*	
	3	
Repeat	Off*	
	Until Stopped	





Control Panel Menu

Item	Parameter	Explanation
Error Tone		
Volume	0	Sets the volume and the repetitions of sounds when an error occurs and printing cannot continue.
	1	
	2	
	3*	
	Repeat	
	Until Stopped*	
Sound Type	Pattern1*	Sets the type of sounds. Sounds that are easy to hear in the printer's operating environment can be set.
	Pattern2	
Alert Lamp Notice	On*	Sets whether or not (On/Off) the alert lamp turns on when an error notification is received.
	Off	
Sleep Timer	1 to 240 (15*)	<p>Sets how long before the printer enters sleep mode when no print jobs are received and no errors are detected. When the printer enters sleep mode, the control panel's screen turns off and the internal motors and other parts switch off to consume less power.</p> <p>To reactivate the control panel display, press any button in the control panel except ⏻. The control panel display will however turn off again if no operations are performed for another 30 seconds under these conditions. The printer is only fully reactivated when a print job is received, or when another operation involving printer hardware is performed.</p>
Wake from Sleep		You can set how to wake the printer from sleep mode.
Touch LCD Screen to Wake		
On*		
Off		
Scheduled	0:00 to 23:45	
Date/Time Settings		
Date/Time		Sets the printer's built-in clock. The time set here is displayed on the Home screen. It is also used for job logs and the printer's status as shown in Epson Edge Dashboard.
Daylight Saving Time	Off (Winter)*	Sets daylight saving time.
	On (Summer)	Winter and Summer are only displayed for the SC-F6470/ SC-F6470H.
Time Difference	-12:45 to +13:45	Sets the time difference with coordinated universal time (UTC) in 15 minute increments. In network environments with a time difference, set this as necessary when administrating the printer.

Control Panel Menu

Item	Parameter	Explanation
Language	Japanese	Select the language used in the control panel display.
	English*	
	French	
	Italian	
	German	
	Portuguese	
	Spanish	
	Dutch	
	Russian	
	Korean	
	Traditional Chinese	
	Simplified Chinese	
	Thai	
	Indonesian	
Turkish		
Background Color	Gray	Select the color scheme used in the control panel display. You can set a color scheme that is easy to see in the environment in which the printer is installed.
	Black*	
	White	
Keyboard	QWERTY*	Select the keyboard layout for the text input screens that are displayed, such as when inputting names to register Media Settings.
	AZERTY	
	QWERTZ	
Unit Settings		
Length Unit	m*	Choose the units of length used in the control panel display and when printing test patterns.
	ft/in	
Temperature	°C*	Choose the temperature units used in the control panel display.
	°F	

Control Panel Menu

Item	Parameter	Explanation
Printer Setup		
Margins		
Right Margin	3 to 25 mm (3*) (0.12 to 0.98 inch [0.12*])	Sets the width of the right margin when media is loaded in the printer. See the following for more information.  "Printable area" on page 48
Left Margin	3 to 25 mm (3*) (0.12 to 0.98 inch [0.12*])	Sets the width of the left margin when media is loaded in the printer. See the following for more information.  "Printable area" on page 48
Margin Between Pages	5 to 999 mm (10*) (0.20 to 39.33 inch [0.39*])	Sets the margin between printed pages. For single-page print jobs, this is the margin placed between jobs.
Top Margin	5 to 35 mm (15*) (0.20 to 1.38 inch [0.59*])	Sets the height of the top margin when media is loaded in the printer. See the following for more information.  "Printable area" on page 48
Bottom Margin	5 to 150 mm (15*) (0.20 to 5.91 inch [0.59*])	Sets the height of the bottom margin when media is loaded in the printer. See the following for more information.  "Printable area" on page 48
Media Detection		
Width Detection	On*	Select whether or not (On) / (Off) the media width is detected. Try setting this to Off when printing if media width errors are displayed even though the media is correctly loaded. However, we recommend setting this to On when using the printer. Changed settings are reflected when the media is reloaded.
	Off	
Media Width	254.0 to 1117.6 mm (254.0*) (10.00 to 44.00 inch [10.00*])	When Width Detection is set to Off , make sure the media width is set correctly here according to the width of the media loaded. Changed settings are reflected when the media is reloaded. If the correct media width is not set, the printer may print beyond the edges of the media. Ink used outside the edges of the media will stain the inside of the printer.
Detect Paper Skew	On*	Select whether the printer will stop printing and display an error (On) or whether the printer will continue printing (Off) when skewed media is detected. On is recommended in most circumstances, as skewed media may cause the printer to jam.
	Off	

Control Panel Menu

Item	Parameter	Explanation
Nozzle Check between Pages		
On	Execution Timing	
	Print Length	1 to 9999 m (99 m*) (3.28 to 32805.12 ft [324.80 ft*])
	Print Page	1 to 9999 pages
	Print Duration	1 to 9999 minutes
	Off*	
When On is set, a nozzle check pattern is printed periodically at the specified timing. When printing is complete, you can visually inspect the check pattern to determine whether there are any stripes or unevenness in the preceding or following printout. Select one of Print Length , Pages , or Print Duration to set the timing for printing the check pattern.		
Information Printing		
Media Remaining Information	On	Prints information, such as the remaining amount of media, when media is removed or replaced.
	Off*	When Media Remaining Information is set to On , the remaining amount is printed on the unused side of the cut position. The following information is printed. To print the media remaining information, set Remaining Amount Management in Media Settings to On . <input type="checkbox"/> Model: Model name of the printer <input type="checkbox"/> Serial No.: Serial number of the printer <input type="checkbox"/> Print Date: Date and time of printing <input type="checkbox"/> Bank No.: Media number when printing <input type="checkbox"/> Media Type: Media Type registered to the media number when printing <input type="checkbox"/> Media Width: Automatically detected value of media width <input type="checkbox"/> Remaining Amount: Remaining amount of media
Print Information	On	
	Off*	
When Print Information is set to On , the following information is printed on the printed side of the cut position. <input type="checkbox"/> Model: Model name of the printer <input type="checkbox"/> Serial No.: Serial number of the printer <input type="checkbox"/> F/W Version: Firmware version of the printer <input type="checkbox"/> Print Date: Date and time of printing <input type="checkbox"/> Bank No.: Media setting number when printing <input type="checkbox"/> Media Type: Media Type registered to the media setting number when printing <input type="checkbox"/> Media Width: Automatically detected value of media width <input type="checkbox"/> Print Length: Amount of media used		

Control Panel Menu

Item	Parameter	Explanation
Cut Settings		
Auto Cut	On*	Select whether or not (On/Off) to automatically cut the media using the built-in cutter each time a page is printed.
	Off	
Restore Default Settings	Network Settings	Executing Network Settings restores all the items for Advanced in the network settings menu to their default setting values.
	Clear All Data and Settings	Executing Clear All Data and Settings restores all settings to their default setting values.

Control Panel Menu

Item	Parameter	Explanation
Maintenance Setting		
Cleaning Setting		
Threshold of Clogged Nozzles	1 to 10 (1*)	<p>The printer monitors the condition of the print head nozzles before printing starts, so set the operation for when clogged nozzles (missing nozzles) are detected during monitoring.</p> <p>When the number of clogged nozzles that are detected exceeds the number set in Threshold of Clogged Nozzles, Head Cleaning is executed as part of maintenance.</p> <p>Max Retry Cleaning Count sets the number of times maintenance can be retried if the clogged nozzles are not cleared after maintenance is done.</p>
	0*	
	1	
Max Retry Cleaning Count	0*	
	1	
	2	
Periodic Cleaning		<p>When On is set, cleaning is done at the interval set for one of Print Duration, Print Counter, or Print Length from Execution Timing. At this time, cleaning is performed at the level set in Cleaning Level.</p>
On		
Execution Timing		
Print Duration	1 to 9999 minutes	
Print Page	1 to 9999 pages	
Print Length	1 to 9999 m (100 m*) (3.28 to 32805.12 ft [328.08 ft*])	
Cleaning Level	Light*	
	Heavy	
Off*		
Actions Beyond Threshold of Missing Nozzles	Stop Printing	
	Show Alert*	
	Auto Cleaning	
Maintenance Cleaning	On*	<p>When On is set, Head Cleaning is performed automatically when the printer is not used for a specified period. This cleaning ejects sedimented ink in the ink tubes to prevent print quality from falling.</p>
	Off	

Control Panel Menu

Item	Parameter	Explanation
Network Settings		
Network Status	Wired LAN Status	You can check batches of a variety of information in network settings that are set in Advanced . When Print Status Sheet is selected, a list is printed.
	Print Status Sheet	
Advanced		
Device Name		Do a variety of network settings.
TCP/IP	Auto	
	Manual	
Proxy Server	Do Not Use	
	Use	
IPv6 Address	Enable*	
	Disable	
Link Speed & Duplex	Auto*	
	100BASE-TX Auto	
	10BASE-T Half Duplex	
	10BASE-T Full Duplex	
	100BASE-TX Half Duplex	
	100BASE-TX Full Duplex	
Redirect HTTP to HTTPS	Enable*	
	Disable	
Disable IPsec/IP Filtering		Use the pre-installed software Web Config to enable this setting.
Disable IEEE802.1X		You can only disable the setting from here. See the following for detailed information on starting Web Config.  "Using Web Config" on page 32

Media Settings Menu

* indicates default settings.

Item	Parameter	Explanation
Current Settings		

Control Panel Menu

Item	Parameter	Explanation
Media	01 XXXXXXXXXXX to 10 XXXXXXXXXXX	Choose the Media Settings to use. The registered name appears in XXXXXXXXXXX.
Media Type		Displays the currently selected Media Type.
Media Width		Sets the Media Detection items.
Advanced Settings		You can change the Advanced Settings for the registered media selected in Media . See the following table for details on the setting content. 🔗 "Media Management items" on page 80
Print Adjustments		
Media Feed Adjustment	Manual (Standard)	Use this menu if you notice banding or graininess in printing results. See the following for more information. 🔗 "Optimizing Media Settings (Print Head Alignment and Media Feed Adjustment)" on page 44
	Manual (Measurement)	
Print Head Alignment		
Media Management		
01 XXXXXXXXXXX to 10 XXXXXXXXXXX		Change the registered Media Settings. 🔗 "Media Management items" on page 80 Press the  area to the right of Media Settings to copy the currently selected settings to another media setting number, or initialize all settings.
Remaining Amount Management		
Remaining Amount Management	On	When On is selected, you can set Remaining Amount and Remaining Alert . Setting each item to manage the remaining amount makes it easier to know when it is time to replace the media. Once this is set to On , when you have loaded the media, you will be prompted to enter the registered media settings number and the media length (Remaining Amount).
	Off*	
Remaining Amount	1.0 to 9999.9 m (100.0 m*) (3.3 to 32808.1 ft [328.1 ft*])	Sets the total length of the loaded media. You can set in increments of 0.1 m (0.1ft). The amount of media remaining is estimated based on the length you set here and the length of the printout, and is displayed on the Home screen.
Remaining Alert	1.0 to 999.5 m (5.0 m*) (3.3 to 3279.2 ft [16.4 ft*])	Sets a value at which point a warning message is displayed to inform you that the remaining amount of media is too low. You can set in increments of 0.1 m (0.1 ft).
Print Length Management		

Control Panel Menu

Item	Parameter	Explanation
Auto Reset	Off*	Select Off (do not automatically reset the value for print length) or After Last Page (reset when starting to print the next job).
	After Last Page	When Off is selected, the value does not reset until you perform Manual Reset . However, once the value reaches 9999, it automatically resets and returns to 0. When After Last Page is selected, the value returns to 0 when printing starts for the next job so you can check the print length per job. You can also check how far along the print job is while printing.
Manual Reset		When a reset is performed, the value for print length returns to 0.

Media Management items

When you select the Media Type when loading media, or download an EMX file using the supplied Epson Edge Print or Epson Edge Dashboard and register the media setting values to the printer, the media setting values are already set to match the media being used and therefore do not need to be changed. When using special media or when a problem such as head striking or banding is detected in printing results, change the default.

The default settings for each of the following items differ depending on the content set in **Media Type**.

Item	Parameter	Explanation
Change Name		Assign a name of up to 20 characters to the Media Settings being saved. Using distinctive names makes it easier to select banks for use.
Media Type	Thin 50g/m2	Select the Media Type according to the loaded media using media thickness (weight) as a guideline.
	Med-Thick 70g/m2*	The guidelines for the paper weight (g/m2) of each Media Type are as follows. The paper weights of each Media Type shown on the screen are typical values. Thinnest: 60 or under Med-Thick: 61 to 89 Thick: 90 or more The printer stores the optimum media settings according to the Media Type. When the Media Type is changed, each setting for media registered to the current media setting number changes to the value for the Media Type after changing.
	Thick 120g/m2	
Advanced Settings		 "Media Settings List for Each Media Type" on page 100

Control Panel Menu

Item	Parameter	Explanation
Drying Time		
Drying Time per Pass	0.0 to 10.0 Secs	Specify how long the printer stops feeding media to allow the ink to dry after printing one pass. You can select a value between 0.0 and 10.0 seconds. The time needed for the ink to dry varies with ink density and the media used. If the ink blurs on the paper, set a longer time for drying the ink. The longer the drying time, the more time required for printing.
Drying Time per Page	0.0 to 60.0 minutes	Specify how long the printer stops feeding media to allow the ink to dry after printing each page. You can select a value between 0.0 and 60 minutes. The time needed for the ink to dry varies with ink density and the media used. If the ink blurs on the paper, set a longer time for drying the ink. The longer the drying time, the more time required for printing.
Platen Gap	1.6	Set the Platen Gap (the distance between the print head and the media).
	2.0	In most situations, use the values set for each media type as they are. If the print results are scratched or smudged, they may be improved by setting a larger value. However, choosing a larger gap than required may result in ink stains inside the printer, reduced print quality, or shorter product life.
	2.5	
Feeding Tension	Lv1 to Lv5	
Paper Suction	Lv0 to Lv6	Set the strength of the suction by the platen on the media. The higher the value, the greater the suction. In most situations, use the values set for each Media Type as they are. If the media is wavy on the platen, increase the set value. If graininess or out-of-focus characteristics are detected in printing results obtained using thin or soft media or if the media is not fed normally, reduce the set value.
Skew Reduction	On	Select whether or not (on/off) the printer performs operations to correct media skew (media fed skewed) when media is loaded. Normally, leave this On . Set this to Off if the media shows marks from the rollers due to skew corrections.
	Off	
Stick Prevention	On	Select whether or not (on/off) to perform non-stick operations when the printer is turned on, when printing begins, and so on.
	Off	Normally, leave this Off . Depending on the type of media, such as ultra-thin media, some may stick more easily to the platen. Starting operations with media stuck to the platen may cause the media to not feed correctly and result in a paper jam. Set On if this happens. Operating time takes longer when On is set.
Rewind Tension ^{*1}	Lv1 to Lv6	We recommend lowering this setting if media wrinkles during printing or if ink sticks to the back of the media in the take up roll. We recommend increasing this setting if there is too much slack in the rewound media. The higher the value, the greater the tension.

Control Panel Menu

Item	Parameter	Explanation
Reduce Print Streak	Off	Normally, leave this Off .
	Light	If this is set when streaks occur in the print results in the vertical or diagonal direction, the streaks may become less noticeable.
	Medium	
	Heavy	

*1 Displayed when the auto take-up reel unit is installed.

Maintenance Menu

Item	Explanation
Print Head Nozzle Check	Print a pattern, and then check the status of the nozzles for the print head. Inspect the pattern visually and perform Head Cleaning if you detect any missing colors. See the following for details. ☞ "Print Head Nozzle Check" on page 64
Head Cleaning	
Auto Cleaning	Execute Head Cleaning. Perform Auto Cleaning first. If this does not clear the clogs, perform in the order Cleaning (Light) and then Cleaning (Heavy) . ☞ "Head Cleaning" on page 65
Cleaning(Light)	
Cleaning(Heavy)	
Cleaning the Maintenance Parts	Print Head Capping Station/Wiper Start cleaning the selected parts. See the following for more information on cleaning. ☞ "Print Head Maintenance" on page 62 ☞ "Cleaning the Capping Station and Wiper" on page 56
Replace Waste Ink Bottle	If you are replacing the waste ink bottle before the message indicating that it is time to replace the waste ink bottle appears on the control panel's screen, do so from this menu. ☞ "When you want to replace it at any time" on page 61
Replace Auto cutter blade	Start replacing the auto cutter blade. See the following for precautions on replacing the parts. ☞ "Replacing the Auto Cutter Blade" on page 63

Supply Status Menu

Displays the amount of wear and the model number for each consumable item.

[☞ "Options and Consumable Products" on page 94](#)

Control Panel Menu

Replacement Part Information Menu

Item	Explanation
Air Unit	Contact your dealer or Epson Support for assistance.
Ink Damper Unit	
Ink Holder* ¹	
Ink Holder (Left)* ²	
Ink Holder (Right)* ²	
Pump Cap Unit	
Ink Tube	

*1 Only displayed for the SC-F6400 Series.

*2 Only displayed for the SC-F6400H Series.

Printer Status Menu

Item	Explanation
Firmware Version	Displays the selected information. If you set the printer name using Epson Edge Dashboard supplied with this printer, that name is displayed in Printer Name .
Printer Auto Take-up Reel Unit*	
Printer Name	
Fatal Error Log	
Operation Report	Total Print Area
	Total Media Feed Length
	Total Carriage Pass
Auto Take-up Reel Unit*	

* Only when the auto take-up reel unit is installed.

Problem Solver

When a Message is Displayed

If one of the following messages is displayed, read and follow the instructions below.

Messages	What to do
<p>The media is not attached to the roll core on the auto take-up reel unit. Attach the media.</p>	<p>Media has not been wound correctly on the auto take-up reel unit. Flip the Auto switch on the auto take-up reel unit to Off, and then perform the following operations.</p> <p>When the leading edge of the media has come off the take-up roll core</p> <ol style="list-style-type: none"> 1. Use adhesive tape to securely stick the leading edge of the media to the take-up roll core. The procedure varies depending on the take-up direction. 🔗 "Loading into the Auto Take-up Reel Unit" on page 38 2. Flip the Auto switch on the auto take-up reel unit to Backward/Forward depending on the take-up direction, and then press the OK button. <p>When an error is displayed during media take-up and printing</p> <ol style="list-style-type: none"> 1. Press the  button on the control panel to feed the media, and then use scissors or a commercially available cutter to cut the media after the final print out. 2. Remove the media from the take-up reel unit. 🔗 "Removing the Take-up Roll" on page 42 3. Place a new take-up paper core and use adhesive tape to securely stick the leading edge of the media to the core. 🔗 "Loading into the Auto Take-up Reel Unit" on page 38 4. Flip the Auto switch on the auto take-up reel unit to Backward/Forward depending on the take-up direction, and then press the OK button.
<p>The Auto Take-up Reel Unit cannot be recognized. Turn off the power and check whether the Auto Take-up Reel Unit is connected correctly.</p>	<p>After reconnecting the cable of the auto take-up reel unit to the printer, turn the printer off and then on again. 🔗 Setup Guide (booklet)</p>
<p>The Auto Take-up Reel Unit cannot be recognized. Is the Auto Take-up Reel Unit attached?</p>	<p>The auto take-up reel unit is not connected. After reconnecting the cable of the auto take-up reel unit to the printer, select Yes, and then turn the printer off and then on again. 🔗 Setup Guide (booklet)</p> <p>To continue printing without using the auto take-up reel unit, select No.</p>
<p>An unsupported media size has been loaded.</p>	<p>The loaded media width is not supported. Press Next, and then remove the media. Media for use in the printer must be at least 254 mm (10 in.) wide. Use media that is at least 254 mm (10 in.) wide.</p> <p>Should this message be displayed with media of a width that can be used in the printer, you may be able to print if you select Off for Width Detection in the Printer Setup menu. 🔗 "General Settings Menu" on page 71</p>

Problem Solver

Messages	What to do
The combination of the IP address and the subnet mask is invalid. For details, see your documentation.	Make sure you have entered the correct values for the IP address and the default gateway. If you do not know the correct values, contact your network administrator.
Recovery Mode	Firmware update failed, and the printer started in recovery mode. Follow the steps below to update the firmware again. 1. Connect the computer and the printer with a USB cable (updates cannot be performed over a network connection when the printer is in recovery mode). 2. Download the latest firmware from the Epson website, and then start the update.

When a Maintenance Call/Service Call Occurs

Error messages	What to do
Maintenance Request: Replace Parts Soon XXXXXXXX	A part used in the printer is nearing the end of its service life. Contact your dealer or Epson Support and tell them the maintenance request code.
Maintenance Request: End Of Parts Service Life XXXXXXXX	You cannot clear the maintenance request until the part is replaced. A printer error occurs if you continue to use the printer.
Printer error. For details, see your documentation. XXXXXX	Printer errors are displayed in the following situations. <ul style="list-style-type: none"> <input type="checkbox"/> The power cable is not connected securely <input type="checkbox"/> An error that cannot be cleared occurs <p>When a printer error occurs, the printer automatically stops printing. Turn off the printer, disconnect the power cable from the outlet and from the AC inlet on the printer, and then reconnect. Turn on the printer again multiple times.</p> <p>If the same call for service is displayed on the LCD panel, contact your dealer or Epson Support for assistance. Tell them the call for service code is "XXXXXX".</p>

Problem Solver

Troubleshooting

You Cannot Print (Because the Printer Does Not Work)

The printer does not turn on.

- **Is the power cable plugged into the electrical outlet or the printer?**

Make sure the power cable is securely plugged into the printer.

- **Is there a problem with the power outlet?**

Make sure your outlet works by connecting the power cable for another electric product.

The printer is not communicating with the computer.

- **Is the cable plugged in properly?**

Confirm that the interface cable is securely connected to both the printer port and the computer. Also, make sure the cable is not broken nor bent. If you have a spare cable, try connecting with the spare cable.

- **Does the interface cable specification match the specifications for the computer?**

Make sure the interface cable specifications match the specifications for the printer and the computer.

 ["System Requirements" on page 101](#)

- **When using a USB hub, is it being used correctly?**

In the USB specification, daisy-chains of up to five USB hubs are possible. However, we recommend that you connect the printer to the first hub connected directly to the computer. Depending on the hub you are using, the operation of the printer may become unstable. If this should occur, plug the USB cable directly into your computer's USB port.

- **Is the USB hub recognized correctly?**

Make sure the USB hub is recognized correctly on the computer. If the computer correctly detects the USB hub, disconnect all USB hubs from the computer and connect the printer directly to the computer USB port. Ask the USB hub manufacturer about USB hub operation.

You cannot print under the network environment.

- **Are the network settings correct?**

Ask your network administrator for the network settings.

- **Connect the printer directly to the computer using a USB cable, and then try to print.**

If you are able to print via USB, there is a problem with network settings. Ask your system administrator, or refer to the manual for your network system. If you cannot print via USB, see the appropriate section in this User's Guide.

The printer has an error.

- **View the message displayed in the control panel.**

 ["Control panel" on page 16](#)

 ["When a Message is Displayed" on page 84](#)

The Printer Sounds Like It Is Printing, but Nothing Prints

The print head moves, but nothing prints.

- **Confirm the printer operation.**

Print a nozzle check pattern. Because a nozzle check pattern can be printed without connecting to a computer, you can check the operations and print status for the printer.  ["Print Head Nozzle Check" on page 64](#)

Check the next section if the nozzle check pattern is not printed correctly.

Problem Solver

- **Is the message *Motor self adjustment* running, displayed on the control panel's screen?**

The printer adjusts the internal motor. Wait for a while without turning off the printer.

The nozzle check pattern is not printed correctly.

- **Perform Head Cleaning.**

The nozzles may be clogged. Print a nozzle check pattern again after performing Head Cleaning.

 ["Head Cleaning" on page 65](#)

- **Has the printer been left unused for a long time?**

If the printer has not been used for a long time, the nozzles may have dried up and have been clogged.

Steps to take when the printer has not been used for a long time  ["Notes when not using the printer" on page 24](#)

Problem Solver

The Prints Are Not What You Expected

When horizontal lines appear or the colors are wrong



Perform the following sequence until the problems in the print results have improved.

1. Perform Head Cleaning

There are three types of Head Cleaning available; **Auto Cleaning**, **Cleaning (Light)**, and **Cleaning (Heavy)**.

Perform **Auto Cleaning** first. If this does not clear the clogs, perform in the order **Cleaning (Light)** and then **Cleaning (Heavy)**.

[🔗 "Print Head Nozzle Check" on page 64](#)



If print results do not improve even after performing Head Cleaning three times

2. Clean the capping station and wiper

Clean using the maintenance kit supplied. See the following before cleaning.

[🔗 "What You'll Need" on page 54](#)

[🔗 "Precautions Regarding Maintenance" on page 54](#)

Cleaning procedure [🔗 "Cleaning the Capping Station and Wiper" on page 56](#)

You can check the cleaning procedure in a video on YouTube.

[🔗 Epson Video Manuals](#)

If the print quality still does not improve, contact your dealer or Epson Support.

If ink drops occur



Perform the following sequence until the problems in the print results have improved.

Problem Solver

1. Perform Head Cleaning

There are three types of Head Cleaning available; **Auto Cleaning**, **Cleaning (Light)**, and **Cleaning (Heavy)**.

Perform **Auto Cleaning** first. If this does not clear the clogs, perform in the order **Cleaning (Light)** and then **Cleaning (Heavy)**.

 ["Print Head Nozzle Check" on page 64](#)



If print results do not improve even after performing Head Cleaning three times

2. Clean the print head

Clean using the head maintenance kit supplied. See the following before cleaning.

 ["What You'll Need" on page 54](#)

 ["Precautions Regarding Maintenance" on page 54](#)

Cleaning procedure  ["Print Head Maintenance" on page 62](#)

You can check the cleaning procedure in a video on YouTube.

 [Epson Video Manuals](#)

If the print quality still does not improve, contact your dealer or Epson Support.

Problem Solver

Print quality is poor, uneven, too light, or too dark.

■ Are the print head nozzles clogged?

If the print head nozzles are clogged, specific nozzles do not fire ink and the print quality declines. Print a nozzle check pattern.

 ["Print Head Nozzle Check" on page 64](#)

■ Have you performed Print Head Alignment?

With bidirectional printing, the print head prints while moving left and right. If the print head is misaligned, ruled lines may be misaligned accordingly. If vertical ruled lines are misaligned with bidirectional printing, perform Print Head Alignment.

 ["Print Head Alignment" on page 44](#)

■ Are you using a genuine Epson ink supply unit?

This printer is developed for use with Epson ink supply unit. Using any other type of ink supply unit may result in reduced print quality.

We recommend using only the genuine ink supply units specified in this manual.

■ Are you using an old ink supply unit?

The print quality declines when an old ink supply unit is used. Use a new ink supply unit. Use all the ink in the ink supply unit before the recommended date printed on ink supply unit.

■ Are media settings correct?

Confirm that the media settings in the software RIP or on the printer match the media actually in use.

■ Have you compared the printing result with the image on the display monitor?

Since monitors and printers produce colors differently, printed colors will not always match on-screen colors perfectly.

■ Did you open the printer cover while printing?

If the printer cover is opened while printing, the print head stops suddenly causing unevenness in the color. Do not open the printer cover while printing.

■ Shake the ink supply units.

The ink may have sedimented (components settling to the bottom of the liquid). Remove the ink supply units and shake them.

 ["Shaking the Ink Supply Units Periodically" on page 58](#)

The print is not positioned properly on the paper.

■ Have you specified the print area?

Check the print area in the settings of the application and the printer.

■ Is the media skewed?

If **Off** is selected for **Detect Paper Skew** in the General Settings menu, printing will continue when the media is skewed and data will appear outside the print area. Set **Detect Paper Skew** to **On** in the General Settings menu.

 ["General Settings Menu" on page 71](#)

■ Is the media wide enough for the print data?

Although under normal circumstances printing stops if the print image is wider than the media, the printer may print beyond the edges of the media when **Off** is set for **Width Detection** in the General Settings menu. Ink used outside the edges of the media will stain the inside of the printer.

Changed settings are reflected when the media is reloaded.

 ["General Settings Menu" on page 71](#)

Problem Solver

Vertical ruled lines are misaligned.

■ Is the print head misaligned? (in bidirectional printing)

With bidirectional printing, the print head prints while moving left and right. If the print head is misaligned, ruled lines may be misaligned accordingly. If vertical ruled lines are misaligned with bidirectional printing, perform Print Head Alignment.

 ["Print Head Alignment" on page 44](#)

The printed surface is scuffed or soiled.

■ Is the media too thick or too thin?

Check the media specifications to determine whether it can be used with the printer. If you are using a software RIP, contact the manufacturer for information on the settings and media that can be used.

■ Is the media wrinkled or creased?

Do not use old media or media with creases in it. Use new media.

■ Is the print head striking the printed surface?

If the printable side of the media is rubbed while printing, increase the gap using **Platen Gap** from the Media Settings menu.

 ["Media Settings Menu" on page 78](#)

■ Is the print head scuffing the edge of the media?

Widen the setting for the **Top Margin** in the Printer Setup menu.

 ["General Settings Menu" on page 71](#)

■ Is the bottom edge of the media getting scratched?

Depending on the content of the print data, the bottom edge of the printable surface may be rubbed leaving scratches. In this situation, increase the **Drying Time per Page** in the Media Settings menu, increase the **Margin Between Pages** in the Printer Setup menu, or add a bottom margin to the print data in the RIP.

 ["Media Settings Menu" on page 78](#)

 ["General Settings Menu" on page 71](#)

 ["Printable area" on page 48](#)

■ Does the interior of the printer need cleaning?

The rollers may need cleaning. Clean the rollers by feeding and ejecting paper.

 ["The printable surface is still dirty even after cleaning the platen" on page 58](#)

The reverse side of the printed media is soiled.

■ Choose On for Width Detection in the menu.

Although under normal circumstances printing stops if the print image is wider than the media, the printer may print beyond the edges of the media when **Off** is set for **Width Detection** in the General Settings menu. Ink used outside the edges of the media will stain the inside of the printer.

Changed settings are reflected when the media is reloaded.

 ["General Settings Menu" on page 71](#)

■ Is ink dry on the printed surface?

Depending on the printing density and media type, the ink may take a while to dry. Do not stack the media until the printed surface is dry.

Problem Solver

Feeding or Ejecting Problems

Unable to feed or eject paper.

■ **Is the media loaded in the correct position?**

See the following for the correct media loading positions.

🔗 ["Loading Media" on page 36](#)

If the media is loaded correctly, check the condition of the media that you are using.

■ **Is media curled, folded, curved, creased, or wavy?**

Cut and remove the curled, folded, curved, creased, or wavy part.

🔗 ["Cutting Media" on page 42](#)

🔗 ["Make settings for Loaded Media" on page 36](#)

■ **Is media loaded just before printing?**

The rollers may crease media left in the printer, or the media may also become wavy or curled.

■ **Is the media too thick or too thin?**

- Check the media specifications to determine whether it can be used in the printer.

🔗 ["Supported Media" on page 98](#)
- For information on how to configure print settings using the software RIP, contact the RIP manufacturer.

■ **Is Paper Suction set too high?**

If you continue to have problems with media ejection, try lowering the **Paper Suction** (the amount of suction used to keep the media on the paper feed path). 🔗 ["Media Settings Menu" on page 78](#)

Media jams

Check the error displayed on the control panel screen, and then follow the on-screen instructions to remove the media.



After removing the media, press **Cancel Print** on the following screen to remove the print job. Press to restart printing from the beginning.

Press **Finish**, and then reload the media to print the rest of the print data.

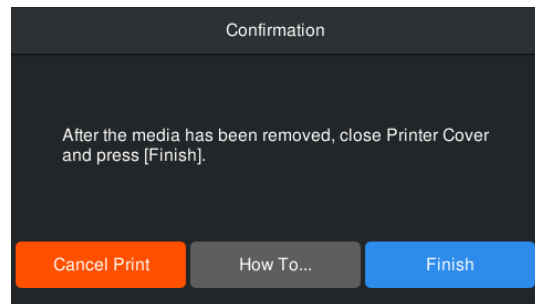

Others

The control panel display keeps turning off.

■ **Is the printer in sleep mode?**

When no operations are performed on the printer for the time set in **Sleep Timer** in the setup menu, the printer enters sleep mode. You can change the time before entering sleep mode in the General Settings menu.

🔗 ["General Settings Menu" on page 71](#)

Problem Solver

Color ink runs out quickly even when printing black data.

- **Color ink is consumed during the Head Cleaning process.**
Performing **Head Cleaning** consumes ink from all colors.

The media is not cut cleanly

- **Replace the cutter.**
Replace the cutter if the media is not cut cleanly or if the edges of the cut sections are fluffy.
[🔗 "Replacing the Auto Cutter Blade" on page 63](#)

A light is visible inside the printer.

- **This is not a failure.**
The red light is a light inside the printer.

The administrator password has been forgotten.

- **Contact your dealer or Epson Support.**

Head Cleaning starts when the printer is turned on

- When turned on after an extended period of disuse, the printer may automatically perform Head Cleaning to ensure print quality.
Head Cleaning will end after about 5 to 7 minutes.

Appendix

Appendix

For the latest information, see the Epson Web site. (as of September, 2022)

Options and Consumable Products

Ink Supply Units

SC-F6400 Series

Printer model	Product name		Part number
SC-F6400 SC-F6460	Ink Supply Unit	High Density Black	T53L9
		Cyan	T53L2
		Magenta	T53L3
		Yellow	T53L4
		Starter Ink set	T53LM
SC-F6430	Ink Supply Unit	High Density Black	T53Q9
		Cyan	T53Q2
		Magenta	T53Q3
		Yellow	T53Q4
		Starter Ink set	T53QM
SC-F6440	Ink Supply Unit	High Density Black	T53P9
		Cyan	T53P2
		Magenta	T53P3
		Yellow	T53P4
		Starter Ink set	T53PM
SC-F6470	Ink Supply Unit	High Density Black	T53K9
		Cyan	T53K2
		Magenta	T53K3
		Yellow	T53K4
		Starter Ink set	T53KM

Appendix

SC-F6400H Series

Printer model	Product name		Part number
SC-F6400H SC-F6460H	Ink Supply Unit	High Density Black	T53L9
		Cyan	T53L2
		Magenta	T53L3
		Yellow	T53L4
		Light Cyan	T53L5
		Light Magenta	T53L6
		Orange	T53LA
		Violet	T53LD
		Fluorescent yellow	T53L7
		Fluorescent pink	T53L8
		Starter Ink set	T53LM
SC-F6430H	Ink Supply Unit	High Density Black	T53Q9
		Cyan	T53Q2
		Magenta	T53Q3
		Yellow	T53Q4
		Light Cyan	T53Q5
		Light Magenta	T53Q6
		Orange	T53QA
		Violet	T53QD
		Fluorescent yellow	T53Q7
		Fluorescent pink	T53Q8
		Starter Ink set	T53QM

Appendix

Printer model	Product name		Part number
SC-F6440H	Ink Supply Unit	High Density Black	T53P9
		Cyan	T53P2
		Magenta	T53P3
		Yellow	T53P4
		Light Cyan	T53P5
		Light Magenta	T53P6
		Orange	T53PA
		Violet	T53PD
		Fluorescent yellow	T53P7
		Fluorescent pink	T53P8
		Starter Ink set	T53PM
SC-F6470H	Ink Supply Unit	High Density Black	T53K9
		Cyan	T53K2
		Magenta	T53K3
		Yellow	T53K4
		Light Cyan	T53K5
		Light Magenta	T53K6
		Orange	T53KA
		Violet	T53KD
		Fluorescent yellow	T53K7
		Fluorescent pink	T53K8
		Starter Ink set	T53KM

Epson recommends the use of genuine Epson Ink Supply Unit. Epson cannot guarantee the quality or reliability of nongenuine ink. The use of non-genuine ink may cause damage that is not covered by Epson's warranties, and under certain circumstances, may cause erratic printer behavior. Information about non-genuine ink levels may not be displayed, and use of non-genuine ink is recorded for possible use in service support.

Others

Product name	Product number	Explanation
Auto Take-up Reel Unit	C12C934671/ C12C935611	This allows you to automatically roll up the printed media while printing.
Roll Adapter	C12C934701	This is the same as the roll adapter supplied with the printer.

Appendix

Product name	Product number	Explanation
Waste Ink Bottle	T7240	This is the same as the Waste Ink Bottle supplied with the printer.
Head Maintenance Kit	C13S400145	Use this to clean the print head.
Maintenance Kit	C13S210063	This is the same as the maintenance kit supplied with the printer.
Auto Cutter Spare Blade	S902006	This is a replacement cutter.

Supported Media

The following media can be used with the printer. Print quality is greatly affected by the type and quality of media used. Choose a media suited to the task at hand. For information on use, refer to the documentation supplied with the media or contact the manufacturer. Before buying media in large quantities, try printing on a smaller sample and check the results.

Important:

Do not use media that is wrinkled, scuffed, torn, or dirty.

Roll media

Roll core size	2 or 3 inch
Roll outer diameter	150 mm (5.9 in.) or less
Media Width*	254 mm (10 inches) to 1118 mm (44 inches)
Media thickness	0.08 to 0.5 mm (0.003 to 0.02 in.)

* 432 mm (17 inches) to 1118 mm (44 inches) when the auto take-up reel unit is installed.

Moving and Transporting the Printer

This section describes how to move and transport the product.

Moving the Printer

This section assumes that the product is being moved to another location on the same floor without traversing stairs, ramps, or lifts. See below for information on moving the printer between floors, to another building, or between non-level floors.

 [“Transport” on page 99](#)

Caution:

Do not tilt the product more than 10 degrees forward or back while moving it. Failure to observe this precaution could result in the printer falling over, causing accidents.





Getting Ready

Make the following preparations in advance before moving the printer.

- Turn off the printer and remove all cables.
- If the printer has a waste ink bottle, install a new waste ink bottle to prevent ink from dripping.
- Remove the media.
- Remove any optional components if they are installed.
- Unlock the stand.

Post-Move Setup

After moving, make the following settings to get ready for printing.

- Check that the location is appropriate for installation, and set up the printer.
North American and Latin American users: Contact your dealer for product installation information. Damage to the product from unauthorized installation will not be covered by your Epson warranty.
Other regions:  [Setup Guide](#) (booklet)
- Plug in the power cables and turn the printer on.
North American and Latin American users: Contact your dealer for product installation information. Damage to the product from unauthorized installation will not be covered by your Epson warranty.
Other regions:  [Setup Guide](#) (booklet)
- Perform a nozzle check to check for clogged nozzles.
 [“Print Head Nozzle Check” on page 64](#)
- Perform Print Head Alignment and check the print quality.
 [“Print Head Alignment” on page 44](#)

Transport

Before transporting the printer, contact your dealer or Epson Support.

Appendix

Media Settings List for Each Media Type

The following table shows the media settings registered when a Media Type is selected.

Item	Media Type		
	Thin	Med-Thick	Thick
Drying Time per Pass	0.0sec	0.0sec	0.0sec
Drying Time per Page	0.0min	0.0min	0.0min
Platen Gap	2.0	2.0	2.0
Paper Suction	Lv5	Lv5	Lv5
Feeding Tension	Lv5	Lv1	Lv1
Rewind Tension*	Lv2	Lv2	Lv2
Skew Reduction	On	On	On
Stick Prevention	Off	Off	Off
Reduce Print Streak	Off	Off	Off

* Only enabled when the auto take-up reel unit is installed.

Appendix

System Requirements

Each software can be used in the following environments. (As of September, 2022)

The supported operating systems vary by region and may change.

For the latest information, see the Epson Web site.

Epson Edge Dashboard



Important:

Make sure the computer on which the Epson Edge Dashboard is installed meets the following requirements.

If these requirements are not met, the software cannot monitor the printer correctly.

- Disable your computer's hibernate function.*
- Disable the sleep function so that the computer does not enter sleep status.*

Windows

Operating systems	Windows 7 SP1 / Windows 7 x64 SP1 Windows 8 / Windows 8 x64 Windows 8.1 / Windows 8.1 x64 Windows 10 / Windows 10 x64 Windows 11
CPU	Intel Core2Duo 2.5 GHz or more
Free memory	1 GB or more
Hard disk (free space during installation)	2 GB or more
Display resolution	1280 x 1024 or better
Communication interface	High Speed USB Ethernet 1000Base-T
Browser	Internet Explorer 11 Microsoft Edge

Mac

Operating systems	Mac OS X 10.7 Lion or later
CPU	Intel Core2Duo 2.5 GHz or more
Free memory	1 GB or more
Hard disk (free space during installation)	2 GB or more

Appendix

Display resolution	1280 x 1024 or better
Communication interface	High Speed USB Ethernet 1000Base-T
Browser	Safari 6 or later

Epson Edge Print

Operating systems	Windows 7 SP1 x64 Windows 8 x64 Windows 8.1 x64 Windows 10 x64 Windows 11
CPU	Intel® Core™ i3 3.0 GHz or faster (released after April 2014)
Free memory	8GB or more
Hard disk (free space during installation)	50 GB or more
Display resolution	1280 x 1024 or better
Communication interface	High Speed USB Ethernet 100Base-TX/1000Base-T

The computer on which this software is installed is expected to be able to simultaneously use other applications, such as Adobe Illustrator. Therefore, we recommend using a computer with the highest specifications available.

In addition, the data that this software handles is normally several GB, and could reach several tens of GB for long high-quality print jobs.

Because of this, we recommend a computer that has a hard disk with sufficient surplus available memory capacity.

Web Config

The following browsers are supported. Make sure you are using the latest version of the browser.

Internet Explorer 11, Microsoft Edge, Firefox, Chrome, Safari

Appendix

Specifications Table

Printer Specifications	
Printing method	On-demand ink jet
Nozzle configuration	SC-F6400 Series: 400 nozzles x 2 rows x 4 colors (High Density Black, Cyan, Magenta, Yellow)
	SC-F6400H Series: 400 nozzles x 1 row x 6 colors (High Density Black, Cyan, Magenta, Yellow, Light Cyan/Fluorescent pink/Violet, Light Magenta/Fluorescent yellow/Orange)
Resolution (maximum)	600x1200dpi
Control code	ESC/P raster (undisclosed command)
Media feed method	Friction feed
Built-in memory	1GB
Interface	SuperSpeed USB 100Base-TX/1000Base-T*1
Rated voltage	AC100 - 240V
Rated frequency	50/60Hz
Rated current	3.4 to 1.6 A
Power consumption	
In use	Approx. 80 W
Sleep mode	Less than 19 W
Power off	Less than 0.3 W
Temperature and humidity (without condensation)	

Printer Specifications	
In use	10 to 35 °C (50 to 95 °F), 20 to 80% Recommended: 15 to 25 °C (59 to 77 °F), 40 to 60%
In storage (Before unpacking)	-20 to 60 °C (-4 to 140 °F), 5 to 85% (Within 120 hours at 60 °C (140 °F), within a month at 40 °C (104 °F))
In storage (Before charging ink)	-20 to 40 °C (-4 to 104 °F), 5 to 85% (Within a month at 40 °C (104 °F))
In storage (After charging ink)	5 to 35 °C (41 to 95 °F), 5 to 85%
<p>Temperature and humidity range</p> <p>Gray area: Printing</p> <p>Cross-hatch lines: Recommended</p>	
Dimension	
Storage dimensions	<p>Printer: (W) 1608 x (D) 745 x (H) 1128 mm (W) 63.3 x (D) 29.3 x (H) 44.4 in.</p> <p>When auto take-up reel unit installed: (W) 1608 x (D) 916 x (H) 1128 mm (W) 63.3 x (D) 36.0 x (H) 44.4 in.</p>
Maximum dimensions	<p>Printer: (W) 1608 x (D) 745 x (H) 1206mm (W) 63.3 x (D) 29.3 x (H) 47.5 in.</p> <p>When auto take-up reel unit installed: (W) 1608 x (D) 916 x (H) 1206mm (W) 63.3 x (D) 36.0 x (H) 47.5 in.</p>
Weight	

Appendix

Printer Specifications	
SC-F6400 Series	120 kg* ² 265lb* ²
SC-F6400H Series	140 kg* ³ 309lb* ³

- *1 Use a shielded twisted pair cable (category 5e or higher).
- *2 Not including ink supply units or the auto take-up reel unit.
- *3 Not including ink supply units. Including auto take-up reel unit.

Auto Take-up Reel Unit Specifications*	
Media Width	432 mm (17 inches) to 1118 mm (44 inches)
Media Outer Diameter	3 inch core: within 150 mm (5.9 in.)
Gross Weight	Approx. 13 kg (29 lb.)
Temperature and Humidity (without condensation)	Recommended: 15 to 25 °C (59 to 77 °F), 40 to 60 % In use: 10 to 35 °C (50 to 95 °F), 20 to 80 %
Rated voltage	AC100 - 240V
Rated frequency	50/60Hz
Rated current	1.0 - 0.5A
Power consumption	Printing: Approx. 5.4 W Sleep mode: Approx. 2.8 W Power off: Approx. 0.45 W

This is optional for the SC-F6400/SC-F6430/SC-F6440/SC-F6460.

Ink Specifications	
Type	Dedicated ink supply unit
Sublimation dye ink	SC-F6400 Series: High Density Black, Cyan, Magenta, Yellow
	SC-F6400H Series: High Density Black, Cyan, Magenta, Yellow, Light Cyan, Light Magenta, Fluorescent pink, Fluorescent yellow, Violet, Orange
Use by date	Date printed on the ink supply unit (stored at normal temperatures)
Print quality guarantee expiry	One year (after installing in the printer)
Storage temperature	5 to 35 °C (41 to 95 °F)
Dimensions (approx.)	180 (W) x 410 (D) x 30 (H) mm (7.08 [W] x 16.2 [D] x 1.18 [H] in.)
Capacity	1600ml

Note:

For stable color printing, maintain a constant room temperature of 15 to 25 °C (59 to 77 °F).

Important:

Use the printer at an altitude of 2000 m (6562 ft.) or less.

Warning:

This is a class A product. In a domestic environment this product may cause radio interference in which case the user may be required to take adequate measures.

Information of EU declaration of conformity

The full text of the EU declaration of conformity of this equipment is available at the following internet address.

<https://www.epson.eu/conformity>

Appendix

ZICTA Type Approval for Users in Zambia

See the following website to check the information for ZICTA Type Approval.

<https://support.epson.net/zicta/>