

brother

# GTX600NB

Professional Use

## GARMENT PRINTER Instruction Manual

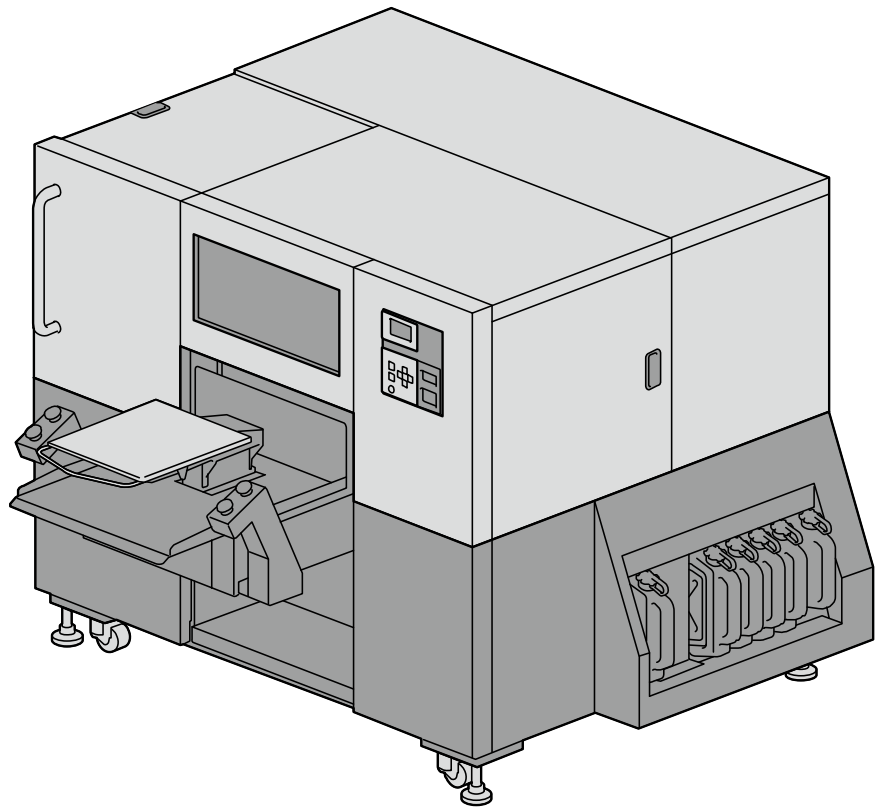

---

Please be sure to read this manual before using this product.

Keep this manual in a safe place for future use.

This printer should only be used by operators who are appropriately trained in its safe operation.

---

# When you dispose of the machine

## Required Tools

Phillips screwdriver: M3 to M5

## Disassembling

- (1) Remove the Cover of BACK SIDE bottom center.

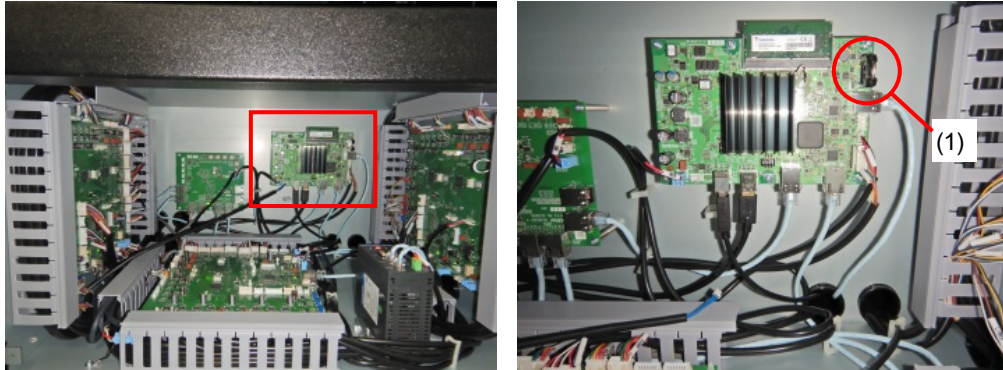

- (2) Remove the Lithium Battery (1) by pulling out the holder in the direction of the arrow.

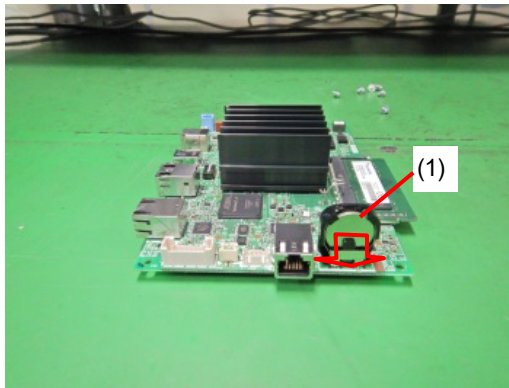

- (3) Pickup the Lithium Battery (1) to the direction of the arrow.



### Note based on California law (USA) on the use and handling of Perchlorate

This product contains a CR Coin Lithium Battery which contains Perchlorate Material – special handling may apply.

See <http://www.dtsc.ca.gov/hazardouswaste/perchlorate>.

# SAFETY INSTRUCTIONS

Thank you very much for buying a BROTHER printer.



Before using your new printer, please read the "SAFETY INSTRUCTIONS" and handling instructions carefully.

## 1. Safety indications and their meanings









This instruction manual and the indications and symbols that are used on the printer itself are provided in order to ensure safe operation of this printer and to prevent accidents and injury to yourself or other people.

The meanings of these indications and symbols are given below.

### Indications

 <b>DANGER</b>	The instructions which follow this term indicate situations where failure to follow the instructions will result in death or serious injury.
 <b>WARNING</b>	The instructions which follow this term indicate situations where failure to follow the instructions could result in death or serious injury.
 <b>CAUTION</b>	The instructions which follow this term indicate situations where failure to follow the instructions may result in minor or moderate injury.
<b>((!)) IMPORTANT</b>	The instructions which follow this term indicate situations where failure to follow the instructions may result in damage to property.
<b>((!)) NOTE</b>	The instructions which follow this term indicate precautions and restrictions for use.

### Symbols

-  . . . . . This symbol () indicates something that you should be careful of.
-  . . . . . The picture inside the triangle indicates the nature of the caution that must be taken. (For example, the symbol at left means "beware of injury".)
-  . . . . . This symbol () indicates something that you must not do.
-  . . . . . This symbol () indicates something that you must do.
-  . . . . . The picture inside the circle indicates the nature of the thing that must be done. (For example, the symbol at left means "you must make a ground connection".)

## 2. Notes on safety

### **DANGER**



Contact with high voltage sections may lead to a serious injury. Turn off the power, and remove the cover 5 minutes later.

## WARNING

### Basic precautions



This printer should only be used by operators who are appropriately trained in its safe operation.



The printer is not suitable for use in places where children are present.



To prevent accidents and problems, do not modify the machine by yourself. Brother will not be held responsible for any accidents or problems resulting from modifications made to the machine.



Do not handle the power cord with wet hands. Otherwise, it may cause electric shocks.

### Installation



Do not set up the printer in a dusty environment. If dust collects inside the printer, it may cause fire or electric shocks or problems with correct operation.



Be sure to connect the ground. If the ground connection is not secure, you run a high risk of receiving a serious electric shock, and problems with correct operation may also occur.



Do not bend the cords excessively or fasten them too hard with staples or anything similar to secure cords. Otherwise, it may cause fire or electric shocks.



Do not connect power to the printer on the floor near the printer. Otherwise, it may cause a fire, electric shock, or malfunction if water drips from the printer.





## WARNING

### Printing



If a foreign object gets inside the printer, immediately turn off the power, disconnect the power cord, and contact the place of purchase or a qualified technician. If you continue to use the printer while there is a foreign object inside, it may result in fire or electric shocks or problems with correct operation.



Do not allow the printer to come into contact with liquids. Otherwise, it may cause fire or electric shocks or problems with correct operation.



If any liquid gets inside the printer, immediately turn off the power, disconnect the power cord, and contact the place of purchase or a qualified technician.



Do not use the printer when smoke or a bad odor is coming from the printer. Otherwise, it may cause fire or electric shocks or problems with correct operation. Immediately turn off the power, disconnect the power cord, and contact the place of purchase or a qualified technician.



Keep your finger or any body part away from the rotating fan. Otherwise, it will be caught up, which results in injuries.

Turn off the power when you approach the fan.

## CAUTION

### Environmental requirements



Use the printer in a place which is adequately ventilated. A slight odor is generated when the printed articles are being fixed by heat.

### Installation



The printer machine weighs 730 kg (1609 lb). Transporting and setting up of the printer should be held in the proper way. Otherwise, the printer may topple over and cause injury.



Unplug the printer and contact the dealer where you purchased the printer or a trained technician if the printer topples over. If you continue to use it, it may result in fire or electric shocks or poor printing quality.



Do not set up the printer in a place where it will be affected by vibration. Otherwise the printing quality may be degraded or the printer may topple over, which causes injury or results in failure of the printer.









Do not connect the power cord until installation is complete. The printer may operate if the power is turned on by mistake, which could result in injury.









Do not climb onto the printer or place heavy objects on top of it. You may get injured if it becomes unbalanced and tips over.

## CAUTION

### Printing

-  This printer should only be used by operators who are appropriately trained in its safe operation.
-  Ensure there is adequate space left in front of the printer and avoid placing any objects. Otherwise, your hand may get caught between the platen and an object, which may result in injury.
-  Do not handle the platen while printing. If your hand gets caught between the platen or the T-shirt tray and the covers, it may be injured.
-  Do not put your hands inside the covers while the printer's power is turned on. Otherwise, your hands may touch against moving parts and this may result in injury.
-  When the pretreatment is applied to printed objects (like a T-shirt) with a spray or pretreatment applicator, sprayed mist is generated. So, wear a pair of plastic gloves, a mask and protective glasses (or goggles) designed to shield against liquid splash, and fully take care of the air ventilation when you are working with it.
-  When a problem occurs with the operation of the printer, contact the place of purchase or a qualified technician.
-  Be careful not to put your hands in the clearance of the cover of the lifting up/down mechanism. Doing so may cause injury.

### Maintenance

-  Be careful not to pinch your fingers when closing each door and cover. You may get injured if you pinch your fingers.
-  When you mount or replace the head, be careful not to get your hands or fingers caught. Otherwise, you may be injured.
-  Do not drink liquids such as the ink, maintenance solution, cleaning solution, pretreatment, or waste. They may cause diarrhea or vomiting.  
When handling liquids, such as the ink, maintenance solution, cleaning solution, pretreatment, and waste ink, use protective glasses and gloves to avoid causing your eyes and skin to contact the liquids. It may cause inflammation. In case of contact with eyes, do not rub but immediately rinse the eyes with water. Keep the liquids out of the reach of children.
-  Be sure to wear protective goggles and gloves when handling the grease, so that it does not get into your eyes or onto your skin.  
It can cause inflammation. Do not drink or eat the grease. It may cause diarrhea or vomiting. Keep the liquids out of the reach of children.
-  When replacing parts and installing optional accessories, be sure to use only genuine Brother parts. Brother will not be held responsible for any accidents or problems resulting from the use of non-genuine parts.
-  When replacing parts or installing optional accessories, be sure to follow the procedures described in the Instruction Manual. Incorrect procedures could cause injuries or problems.
-  Follow the corresponding instructions in the manual when you put your hands inside the cover during regular maintenance while the power is turned on.

**((!)) IMPORTANT****Printing**

Do not move the platen by hand. Otherwise, the printer may be mechanically and electrically damaged.



Ensure there is adequate space left in front of the printer and avoid placing any objects. The platen may be hit and damaged.

**((!)) NOTE**

Use the printer in an area which is free from sources of strong electrical noise such as electrical line noise or static electric noise. Sources of strong electrical noise may cause problems with correct operation.



Any fluctuations in the power supply voltage should be within  $\pm 10\%$  of the rated voltage for the printer. Voltage fluctuations which are greater than this may cause problems with correct operation.



The power supply capacity should be greater than the requirements for the printer's power consumption. Insufficient power supply capacity may cause problems with correct operation.



In the event of an electrical storm, turn off the power and disconnect the power cord from the wall outlet. Lightning may cause problems with correct operation.

3. Warning labels

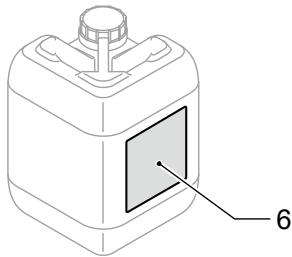
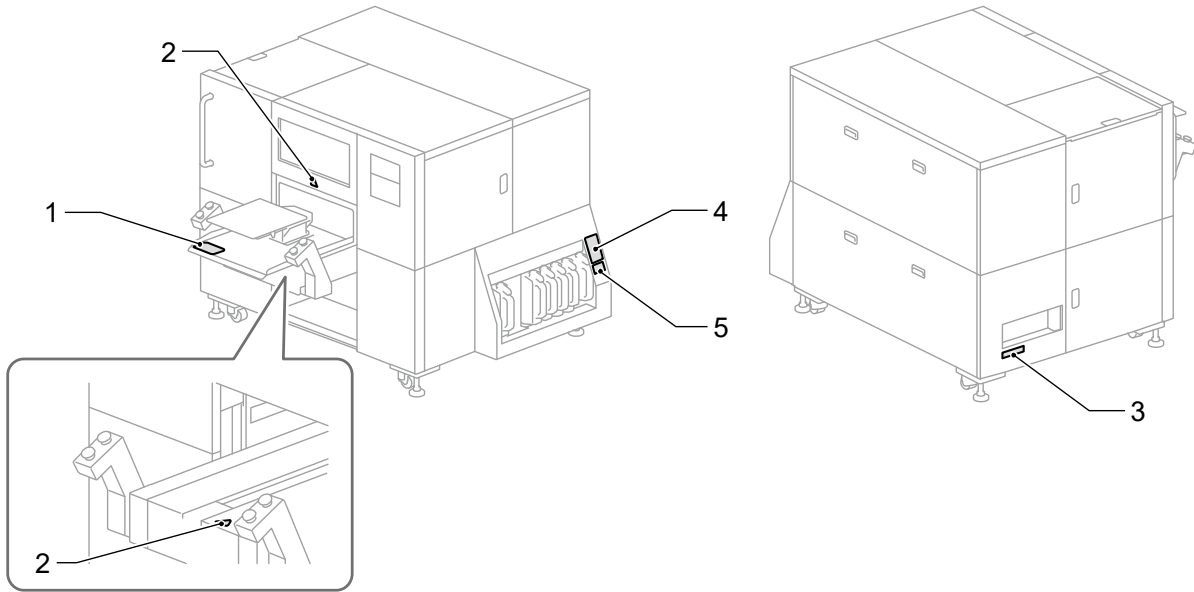

Waste ink tank

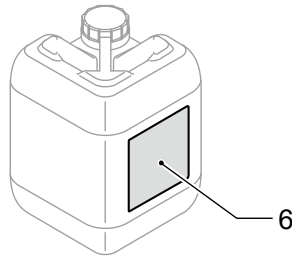

Waste water tank

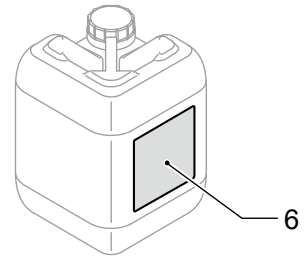

Ink bottle  
9 L

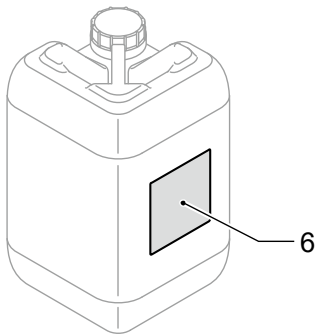

Ink bottle  
18 L

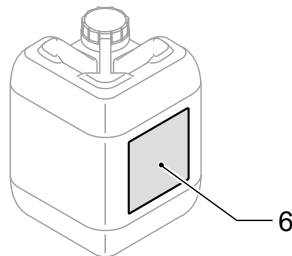

Cleaning solution bottle  
9 L

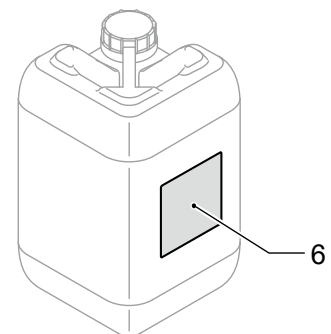

Cleaning solution bottle  
18 L

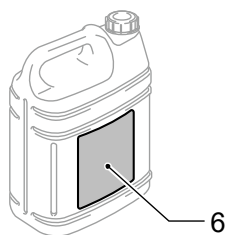

Pretreatment  
5 kg (11 lb)

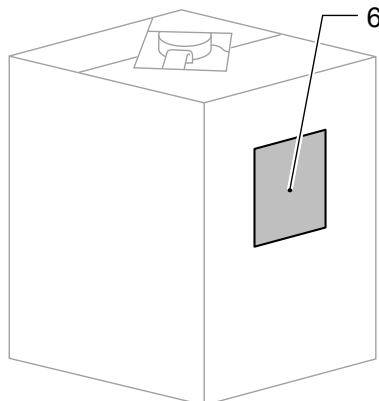

Pretreatment  
20 kg (44 lb)

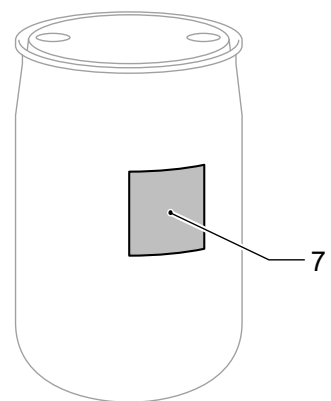

Pretreatment  
200 kg (440 lb)

This printer has the following warning labels displayed on it.  
Follow the precautions given on each warning label for your work.  
When the label is peeled off or illegible, contact the place of purchase.

1

	<b>CAUTION</b> Moving platen, T-shirt tray and covers can cause bodily injury. Keep body parts away from moving parts.
	<b>VORSICHT</b> Druckplatte, T-Shirt-Ablage und Abdeckungen können körperliche Verletzungen verursachen. Halten Sie Körperteile von beweglichen Teilen fern.
	<b>ATTENTION</b> Déplacement du plateau, chargeur T-shirt et couvercle peut blesser le corps. Gardez les parties du corps éloignées des pièces mobiles.
	<b>ATENCIÓN</b> Moviendo la placa, la bandeja de camiseta y las cubiertas pueden causar una herida personal. Mantenga las partes del cuerpo alejadas de las partes móviles.
	<b>ATTENZIONE</b> Tavoletta mobile, il ripiano per la T-shirt ed il carter potrebbero causare infortuni. Tenere le parti del corpo lontane dalle parti in movimento.
	<b>注意</b> プラテンやTシャツトレイと各カバーとの間に手をはさみ、けがをす。運動部分から体を離すこと。
	<b>注意</b> 手夹在压板、T恤托盘和各罩盖之间会导致受伤。身体切勿靠近正在运行的机器部位。



3

	<b>危険</b> 再電圧部分にふれて、大けがをすることがある。 電源を切り、5分たってからカバーを開くこと。	<b>危険</b> 接触高电压部分、会导致受伤。 在切断电源5分钟后、再开原盖。
<b>DANGER</b>	<b>GEFAHR</b>	<b>PERIGRO</b>
Hazardous voltage will cause injury. Turn off main switch and wait 5 minutes before opening this cover.	Hochspannung verletzungsgefahr! Bitte schalten sie den Hauptschalter aus und warten sie 5 minuten, bevor sie diese abdeckung öffnen.	Un voltage inadecuado puede provocar las heridas. Apagar el interruptor principal y esperar 5 minutos antes de abrir esta cubierta.

4

<b>CAUTION</b>
Take care not to let the liquids come into contact with your eyes or onto your skin, otherwise inflammation can result.
<b>ACHTUNG</b>
Vermeiden Sie den Kontakt der Flüssigkeiten mit Augen und Haut, sonst können diese gereizt werden.
<b>ATTENTION</b>
Veillez à ne pas laisser ces liquides être en contact avec les yeux ou la peau, car ceci pourrait entraîner une inflammation.
<b>ATENCIÓN</b>
Tome el cuidado para no permitir que los líquidos toquen los ojos ni en la piel, de otro modo inflamación puede resultar.
<b>ATTENZIONE</b>
Evitare il contatto di questi liquidi con gli occhi e con la pelle poiché potrebbero creare infiammazioni.
<b>注意</b>
炎症を起こす可能性がある。 インクなどの液体類が目や皮膚に付かないようにすること。

5

<b>注意</b>
有可能引发炎症。 注意油墨等液体类不要飞溅到眼中或皮肤上。

6

<b>CAUTION</b>	<b>VORSICHT</b>
Do not drink the liquids under any circumstances, as they can cause vomiting and diarrhea. Take care not to let the liquids come into contact with your eyes or onto your skin, otherwise inflammation can result. Keep the liquids out of the reach of children.	Bitte trinken Sie nicht die Flüssigkeiten, da die Gefahr von Erbrechen und Durchfall besteht. Vermeiden Sie den Kontakt der Flüssigkeiten mit Augen und Haut, sonst können diese gereizt werden. Halten Sie die Flüssigkeiten von Kindern fern.
<b>ATTENTION</b>	<b>ATENCIÓN</b>
Ne pas avaler les liquides d'aucune manière, car ceci pourrait entraîner vomissements et diarrhée. Veuillez à ne pas laisser ces liquides être en contact avec les yeux ou la peau, car ceci pourrait entraîner une inflammation. Maintenez les liquides hors de portée des enfants.	No tome los líquidos en cualquier caso, como pueden causar vomitar y diarrea. Tome el cuidado para no permitir que los líquidos toquen los ojos ni en la piel, de otro modo inflamación puede resultar. Mantenga los líquidos fuera del alcance de niños.
<b>ATTENZIONE</b>	<b>注意</b>
Non bere per nessun motivo i liquidi poiché possono causare vomito e diarrea. Evitare il contatto di questi liquidi con gli occhi e con la pelle poiché potrebbero creare infiammazioni. Conservare i liquidi lontano dalla portata dei bambini.	下痢・おう吐する可能性がある。インクなどの液体類を飲まないこと。炎症を起こす可能性がある。インクなどの液体類が目や皮膚に付かないようにすること。子供の手の届かないところに置くこと。
<b>注意</b>	<b>注意</b>
有可能导致腹泻、呕吐。请勿饮用油墨等液体类。有可能引发炎症。注意油墨等液体类不要飞溅到眼中或皮肤上。请放置在儿童无法触及的地方。	
■ Deposit in compliance with your local regulations. ■ Gebrauchte es gemäß örtlichen Richtlinien entsorgen. ■ Jetez conformément à la réglementation locale en vigueur. ■ Deseche siguiendo la normativa local. ■ Smaltire in conformità alle normative locali. ■ 地域の法令に従って廃棄してください。■ 应按照当地法律废弃。	

7

Use Before					
<b>CAUTION</b>					
Take care not to let the liquids come into contact with your eyes or onto your skin, otherwise inflammation can result. Keep the liquids out of the reach of children.					
Do not drink the liquids under any circumstances, as they can cause vomiting and diarrhea.					
Opening the seal cap with bare hands may cause injury. Use pliers to open the seal cap.					
Heavy drum could cause injury or backache. Do not lift or move the drum without mechanical assistance.					
<b>NOTE</b>					
Deposit in compliance with your local regulations. Do not overlighten.					

## 1. Before Using Your Printer for the First Time 1-1

1-1. Be sure to read the following notes before using the printer .....	1-1
1-2. Components included with printer .....	1-5
1-3. Other items you must make available for use .....	1-6
1-4. Name and function of each component .....	1-8
1-4-1. Front part .....	1-8
1-4-2. Right side view .....	1-10
1-4-3. Left side view/Rear side view .....	1-11
1-4-4. Inside the cover .....	1-12
1-4-5. Operation panel .....	1-13
1-5. About the humidifier .....	1-19
1-5-1. About the water used .....	1-19
1-5-2. Water supply .....	1-19

## 2. Menu list 2-1

## 3. Installation and preparation 3-1

3-1. Installation of printer .....	3-2
3-2. Initial installation of printer .....	3-3
3-2-1. Level adjustment .....	3-3
3-3. Power supply of printer .....	3-5
3-3-1. Turning on the power .....	3-5
3-3-2. Turning off the power .....	3-6
3-3-3. When there is no prospect of electric power recovery for a while due to power outage .....	3-7
3-4. Connection between Printer and PC (for Windows) .....	3-10
3-4-1. Installing printer driver onto your PC .....	3-11
3-4-2. Connecting the printer to your PC via a LAN cable: Adding a printer to PC .....	3-12
3-5. Connection between Printer and PC (for Macintosh) .....	3-19
3-5-1. Installing printer driver onto your PC .....	3-19
3-5-2. Connecting the printer to your PC via a LAN cable .....	3-20
3-6. Adjustment .....	3-23
3-6-1. Initial settings after head replacement .....	3-24
3-6-2. Color adjustments between the two color heads .....	3-25
3-6-3. Firing adjustment .....	3-26
3-6-4. 2 same color heads position adjustment .....	3-27
3-6-5. Platen-rolling adjustment .....	3-28
3-6-6. White/color alignment .....	3-29
3-6-7. Setting of the time displayed on the nozzle check pattern .....	3-30
3-6-8. Set the scheduled time for white ink circulation .....	3-32
3-6-9. Humidification Schedule Settings .....	3-35
3-7. Moving the printer .....	3-39

<b>4. Creating print data</b>	<b>4-1</b>
4-1. Types of applications .....	4-1
4-2. Sending print data using Brother GTX-6 FileOutput (for Macintosh only) .....	4-3
4-3. Using other applications .....	4-4
4-3-1. When using CorelDRAW .....	4-4
4-3-2. When using Adobe Photoshop .....	4-11
4-3-3. When using Adobe Illustrator .....	4-16
4-4. Driver settings for print data using white ink .....	4-22
4-4-1. Setting up the printer driver .....	4-22
4-4-2. Select the platen size .....	4-24
4-4-3. Select the ink type .....	4-25
4-4-4. Select the mode .....	4-26
4-4-5. Select the resolution .....	4-27
4-4-6. Set up the white ink .....	4-28
4-4-7. Specify whether or not to use the background black color .....	4-31
4-4-8. Specify whether or not to perform Multiple Pass Printing .....	4-32
4-4-9. Set up the white ink .....	4-33
4-4-10. Set up the image quality .....	4-36
4-4-11. Set up the color balance .....	4-37
4-4-12. Specify the print direction .....	4-38
4-5. Driver settings for print data using color ink and black ink only .....	4-39
4-5-1. Setting up the printer driver .....	4-39
4-5-2. Select the platen size .....	4-41
4-5-3. Select the ink type .....	4-42
4-5-4. Specify whether or not to perform Multiple Pass Printing .....	4-43
4-5-5. Set up the color ink .....	4-44
4-5-6. Set up the image quality .....	4-46
4-5-7. Set up the color balance .....	4-47
4-5-8. Specify the print direction .....	4-48
4-6. Using Useful Tools .....	4-49
4-6-1. Use the color palette .....	4-49
4-6-2. Replace RGB=255 with RGB=254 (for Photoshop only) .....	4-49
4-6-3. Check the color sample .....	4-50
4-6-4. Print a grid pattern on the platen sheet .....	4-51
4-6-5. Adjust the ink volume .....	4-52
4-6-6. Print out of highlight check pattern/mask check pattern .....	4-53
4-6-7. Color adjustment for 2 color heads .....	4-54
4-6-8. Check the ejection timing .....	4-54
4-6-9. Position adjustment for the 2 heads of the same color .....	4-55
4-6-10. Platen feed adjustment .....	4-55
4-6-11. Check the print position .....	4-56

**5. Basic printing procedures****5-1**

5-1. Basic printing process flow .....	5-3
5-2. Tasks to be performed before starting print operation .....	5-4
5-2-1. Checking the ejection from the head .....	5-4
5-2-2. Confirmation of Water Supply Tank.....	5-4
5-3. Pretreating process for print medium .....	5-5
5-3-1. Provisions for pretreatment .....	5-5
5-3-2. Dilution of pretreatment .....	5-7
5-3-3. Application of pretreatment .....	5-9
5-3-4. Fixation of pretreatment.....	5-12
5-4. Platen adjustment.....	5-14
5-4-1. Replacing the currently used platen with another one .....	5-14
5-4-2. Platen height adjustment.....	5-16
5-5. Placing print medium in position.....	5-17
5-6. Sending/Loading Print Data .....	5-20
5-6-1. Sending print data from ARX6 file preview .....	5-20
5-6-2. Sending print data from applications.....	5-24
5-6-3. Loading print data (ARX6 file) from USB flash memory.....	5-27
5-7. Executing a printing job .....	5-29
5-7-1. Executing a print job once for a single print medium.....	5-29
5-7-2. Executing a print job several times for multiple print media .....	5-30
5-7-3. Performing the printing from receiving history .....	5-31
5-8. Scheduling a print.....	5-32
5-8-1. When you can schedule printing.....	5-32
5-8-2. When a scheduled print begins.....	5-32
5-8-3. When printing does not begin .....	5-32
5-8-4. Canceling scheduled printing .....	5-32
5-9. Removing printed matter from platen.....	5-33
5-10. Fixation of ink.....	5-34



## 6. Precautions to keep good printing quality/use printer over the long term 6-1

6-1. Tasks to be performed regularly .....	6-2
6-1-1. Refilling color ink .....	6-2
6-1-2. Refilling white ink .....	6-4
6-1-3. Refilling the cleaning solution .....	6-8
6-1-4. Correcting the remaining ink level .....	6-10
6-1-5. Replacement of maintenance parts .....	6-11
6-1-6. Replacing the wiper .....	6-12
6-1-7. Replacing the cap chip and cap foam .....	6-14
6-1-8. Replacing the flushing foam .....	6-17
6-1-9. Replacing the carriage foam .....	6-20
6-1-10. Replacing the mist fan filter .....	6-28
6-1-11. Replacing the platen sheet .....	6-30
6-1-12. Replacement of print head .....	6-32
6-1-13. Cover adjustments .....	6-37
6-1-14. Tube air bleed .....	6-40
6-1-15. Head cleaning .....	6-41
6-1-16. White ink circulation .....	6-43
6-1-17. Print out the nozzle check pattern (checking on the print heads) .....	6-44
6-2. Cleaning .....	6-46
6-2-1. Cleaning the nozzle guard and suction cap .....	6-46
6-2-2. Cleaning and replacing maintenance parts .....	6-56
6-2-3. Cleaning the surrounding area of nozzle surface .....	6-57
6-2-4. Disposal of waste ink and waste water .....	6-60
6-3. When Not Using for a Long Period of Time .....	6-62
6-3-1. When Not Using for a Long Period of Time: within 2 weeks .....	6-62
6-3-2. When Not Using for a Long Period of Time: more than 2 weeks .....	6-62

## 7. What to do when needed 7-1

7-1. Setting the print direction .....	7-3
7-2. Screen back light adjustment .....	7-3
7-3. Setup of Auto Screen Erase Time .....	7-4
7-4. Setting the menu timeout period .....	7-4
7-5. Speaker volume setting .....	7-5
7-6. Setup of temperature indication .....	7-5
7-7. Preview display settings .....	7-6
7-8. File name display setting .....	7-6
7-9. Platen Setting .....	7-7
7-9-1. User settings for height .....	7-7
7-9-2. Configuring the obstacle sensor to work during the printing process .....	7-7
7-9-3. Platen too low sensor setting .....	7-8

7-10. Print Operation Settings Under Low Temperature .....	7-8
7-11. Print Operation Settings Under Low Humidity .....	7-9
7-12. Auto Cleaning Setting .....	7-10
7-13. Setting Automatic Multiple Pass Settings .....	7-11
7-14. Flushing Interval Setting .....	7-12
7-15. Flushing Volume Setting .....	7-12
7-16. Automatic deletion of print data .....	7-13
7-17. Network filtering settings .....	7-13
7-18. Static IP address setting .....	7-14
7-19. Shortcut button setting .....	7-15
7-20. Display of total printed sheets .....	7-15
7-21. Display of Temperature/Humidity Info .....	7-16
7-22. Confirm network setting .....	7-17
7-23. Check circulation schedule .....	7-18
7-24. Check humidification schedule .....	7-18
7-25. Language setting .....	7-19
7-26. Display of version .....	7-20
7-26-1. Updating of firmware .....	7-21

## 8. Troubleshooting 8-1

8-1. Troubleshooting instructions .....	8-2
8-2. Solutions to print quality problems .....	8-7
8-2-1. Recovery action to be taken for such a nozzle that is unable to eject ink-jet droplets .....	8-13
8-3. Acquisition of log file .....	8-19

## 9. Error message 9-1

## 10. Specifications 10-1

10-1. Apparatus .....	10-1
10-2. Software .....	10-2
10-3. Ink, maintenance solution, cleaning solution, pretreatment .....	10-3
10-3-1. Ink .....	10-3
10-3-2. Maintenance solution .....	10-3
10-3-3. Cleaning solution .....	10-3
10-3-4. Pretreatment .....	10-4
10-4. About consumable supplies, optional items and replacement parts .....	10-5

**1-1. Be sure to read the following notes before using the printer**

Keep in mind the following points before using the printer:

**Precautions for proper use**

- **PLEASE LEAVE THE PRINTER POWERED ON 24 HOURS A DAY.**  
Even when the printer is placed in standby mode, it performs such maintenance as white ink circulation inside the main unit automatically to prevent sedimentation of the white ink.
- **Please use the printer within the scope covered by its warranty for the best print result (temperature: 18 to 30°C (64.4 to 86°F) and humidity: 35 to 85%).**  
Otherwise, the print heads may be clogged with ink and ink may splash.
- **Adjust the height of the platen according to the print medium before using it.**  
Adjust the height and check that the platen is not detected by the obstacle sensor.
- **Do not excessively lower the platen.**  
Otherwise, ink mist will be scattered inside the printer, which may result in staining of the printing surface, blurring of the printed image, and malfunction of the sensor and the main unit. Increase the platen height if the platen too low sensor is activated.  
☞"5-4-2. Platen height adjustment >>P.5-16"
- **Never power off the printer or open the cover while the printer is in operation.**  
Otherwise, the printer may break down or a print job may end up in failure.
- **Until the ink is firmly fixed, do not touch the printed part.**  
If a T-shirt is soiled with such ink that has not been firmly fixed on its surface, such ink stain cannot be removed even by washing.

**About ink bottle**

- **Refill ink into the ink bottle of the same color as the ink bottle seal.**
- **Shake the white ink well until no deposits remain on the bottom of the bottle.**  
Otherwise, the white ink may precipitate.  
☞"6-1-2. Refilling white ink >>P.6-4"
- **Store consumable goods in a place where they are not exposed to direct sunlight, high temperatures, or low temperatures.**
- **Use up the ink and pretreatment before their shelf life.**  
Use of an expired ink bottle may make you liable for the cost of repairs even during the guarantee period.
- **In order to take full advantage of the printer capabilities, we recommend to use the ink specified by us.**  
In cases where the printer malfunctions due to the use of non-genuine ink, you may be liable for the cost of repairs even during the guarantee period.
- **Be sure to close the ink tank lid once you have refilled the ink.**
- **Handle the ink bottle with care.**

- **Handle the IC stick with care.**  
Take care not to lose the IC stick.  
Once you have refilled ink, you cannot print until you insert the IC stick.

## About pretreatment

- **Apply the pretreatment when using white ink.**  
If a T-shirt to which the pretreatment is applied is coated with only color inks, its stains may be wiped off by washing.
- **After a T-shirt is coated with the pretreatment, store pretreatment in a place where it is not exposed to direct sunlight, and wash it with clean water at an early stage after ink is applied to it.**  
When a white or light-colored T-shirt is coated with the pretreatment, the coated surface color may change, and cannot be restored to the original color even if the T-shirt is washed.
- **When performing printing for the first time, try pretreatment in an unnoticeable area.**  
Some T-shirts may be discolored by the pretreatment and cannot be restored to the original color even if they are washed.
- **Wash away any imprint of the pretreatment with water.**
- **When a color transfer occurs, wipe the color-transferred area clean of dirt with a soft and clean cloth or a toothbrush that is moistened with a small amount of mild detergent for home use or alcohol.**  
If a printed material is rubbed with vinyl-chloride-based white or light-colored synthetic leather, color transfer may occur.  
Also, when a color-printed surface is rubbed strongly against a printed surface with only white ink, color transfer may occur in the same fashion.

## About maintenance

- **If you put your hands inside the cover during regular maintenance while the power is on, follow the instructions in this manual.**
- **In order to keep good printing quality, perform maintenance on a regular basis.**  
☞"6. Precautions to keep good printing quality/use printer over the long term >> P.6-1"
- **We recommend to use the genuine cleaning solution that is specified by us when cleaning the head or cap.**  
This allows you to take full advantage of the printer's intrinsic capabilities and use it for a long period.  
Using commercially available alcohol or cleaning solution could cause damage to the print heads.
- **Never remove the print heads except when they are replaced with new ones.**  
Because they are precision components, the print head may fail.

## What to do when not using printer

- **When the printer will not be used for a prolonged period of time, take appropriate procedures before storing the printer depending on storage period or condition.**  
☞"6-3. When Not Using for a Long Period of Time >> P.6-62"

## About waste handling

- **Dispose of the residual wastes and waste ink properly as water-based waste fluid in accordance with applicable laws and ordinances.**

## Others

- **In the event that the printer is relocated elsewhere for layout change, etc., place a level gauge on the top surface of the platen to make such an adjustment that the printer will be placed horizontally level.**
- You cannot connect this product directly to the communications lines, including the public wireless LANs, of telecommunication carriers like mobile communications companies, fixed communications companies, or internet providers. Ensure that the product is connected through a router, if it is to be used over the internet.

### <NOTE>

- This apparatus is Class A information technology equipment based on the standards of the Voluntary Control Council for Interference by Information Technology Equipment (VCCI). Using this apparatus in a home environment may cause radio interference. In that case, the user may be required to take appropriate measures.

## About trademarks

The names of operating systems described in the main context of this manual are abbreviated. Product names used in this manual are, in general, trademarks or registered trademarks of their respective developer or manufacture. However, in this manual, the ® marks or TM marks are not used.

Brother logo is registered trademark of Brother Industries, Ltd.

Apple, Macintosh, Mac OS, iOS, OS X, macOS, Safari, iPad, iPhone, iPod and iPod touch are the trademarks or registered trademarks of Apple Inc. in the United States of America and other countries.

The official name of Windows® 10 is Microsoft® Windows® 10 operating system (represented as Windows 10 in this manual).

Microsoft® and Windows® 10 are trademarks and registered trademarks of Microsoft Corporation in the United States of America and other countries.

Corel, Corel's logo and CorelDRAW are trademarks and registered trademarks of Corel Corporation.

Adobe, Adobe's logo, Acrobat, Photoshop, and Illustrator are trademarks of Adobe Systems Incorporated (Adobe Systems).

Other product and company names mentioned herein may be the trademarks or registered trademarks of their respective owners.

Information in this document and the specifications of this product are subject to change without notice.

## About the CE declarations

Downloadable from: <https://www.brother.com>

## About software

This printer uses its own software.

To use this printer, you are required to agree with the End-User License Agreement for Brother Software as mentioned below.

### End-User License Agreement for Brother Software

You can use this software if you agree to comply with the terms of the End-User License Agreement. You cannot use this software unless you agree to comply with the terms.

#### 1. Ownership

The rights for this software and its reproductions belong to Brother Industries, Ltd. (hereafter referred to as the "Company") or its suppliers. The Company does not transfer the copyright related to this software to you under this agreement.

#### 2. Permission for license

2.1 The Company grants you a non-exclusive right to use this software.

2.2 You cannot conduct any of the following acts:

- (1) Modifications of all or part of this software,
- (2) Reverse engineering, disassembly, or decompilation,
- (3) Loaning or leasing this software,
- (4) Keep this software available for download in public.

#### 3. No warranty

The Company provides this software without any warranty, either expressed or implied, including but not limited to a warranty for free of defects, fitness for a particular purpose, and non-infringement of third party rights.

#### 4. Limitation of liability

The Company shall not be liable for any direct or indirect damages caused by or connected with this software.

#### 5. Termination of license

The Company may terminate this agreement without notice if you violate the terms and conditions outlined in this agreement.

#### 6. Governing law

This agreement shall be construed in accordance with Japanese law.

## 1-2. Components included with printer

The components included with the printer are shown below. However, in the event that there is any missing component(s), please contact your dealer.

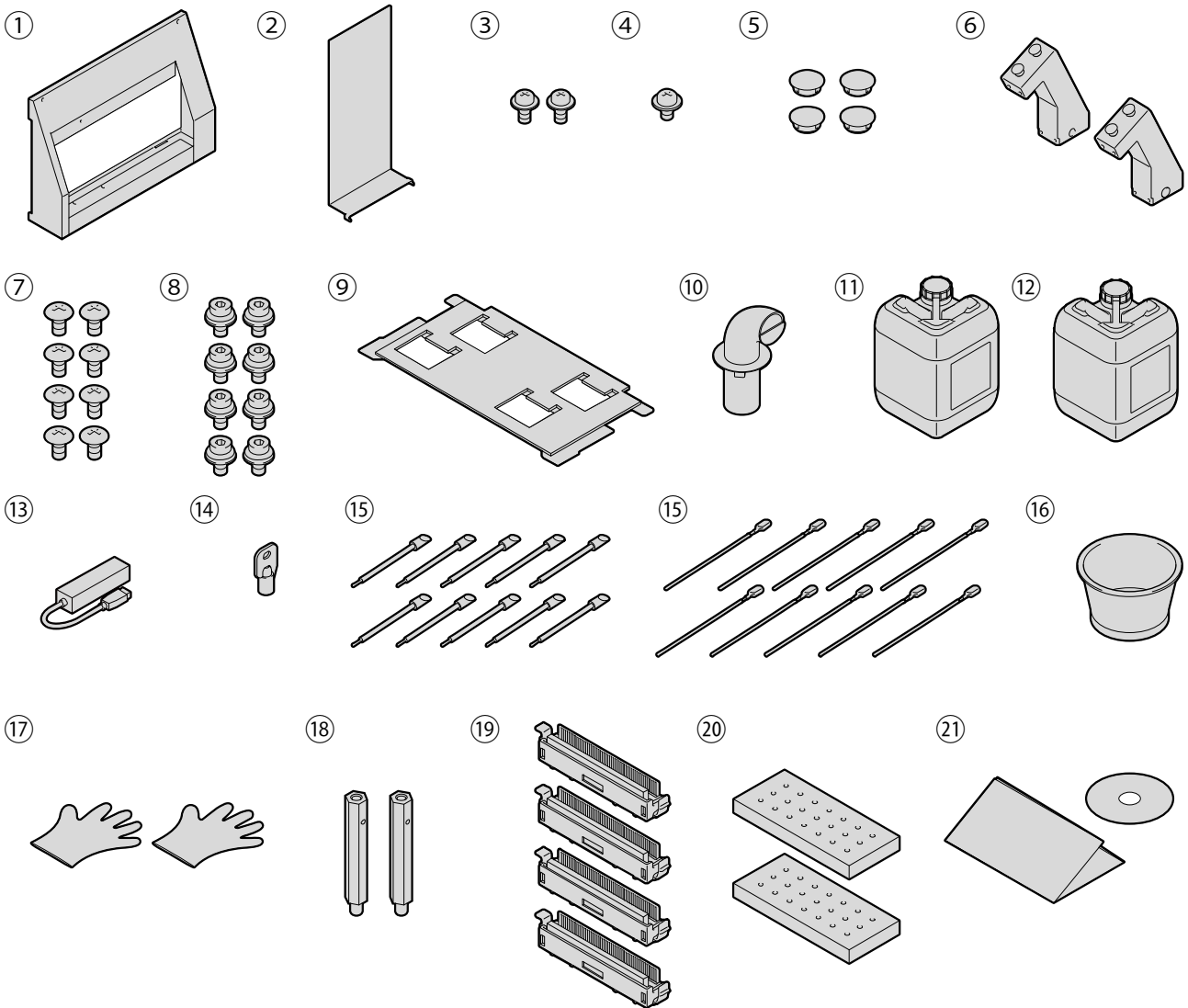

X1068

No.	Name	Quantity	No.	Name	Quantity
1	Main tank cover	1	12	Waste water tank	1
2	Main tank cover S	1	13	USB hub	1
3	Main tank cover installation screw (M4)	2	14	Key to main body door *1	6
4	Main tank cover S installation screw (M3)	1	15	Clean stick R	10
5	Hole cap (black)	4		Clean stick T	10
6	Print switch unit	2	16	Cleaning cup	1
7	Print switch cover installation screw	8	17	Gloves	2
8	Print switch unit installation screw	8	18	Cam fixing pin	2
9	Carriage foam	1	19	Wiper blade	4
10	Humidifier pipe R	1	20	Flushing foam	2
11	Waste ink tank	1	21	Setup Manual	1

\*The print heads and mist fan filter are attached to the main body before shipping.

### <TIPS>

\*1: The administrator should keep the key.

### 1-3. Other items you must make available for use

#### What you buy from our distributors

- Cleaning solution
- Pretreatment
- AC power cord

#### <NOTE>

- There is a risk of malfunction or fire if you use other cables than the specified one. Purchase the cable (optional item) from your dealer. Also, do not use any extension cable.

#### Others

- LAN cable (10BASE-T/100BASE-TX/1000BASE-T)
- USB flash memory  
Please use a FAT32-formatted USB flash memory of which storage capacity is 2 GB to 32 GB in total. You cannot use a USB memory with security functions such as password lock function or beyond 32 GB.
- Pure water  
Pure water refers to clear water, such as distilled water or purified water, to dilute the pretreatment and supply to the humidifier.

#### <NOTE>

- Avoid using such water as tap water in which impurities are contained.
- Heat press  
It must deliver the performance through which the print range of the size of a platen to be used can be covered and 180°C (356°F) can be kept for 35 seconds or more. At a fixing stage of the pretreatment, be sure to use the heat press, but not an oven, to smoothen the surface fluff.
- Peel-off sheet  
Always use this sheet to flatten the fixed surface and enhance the peel property when fixating the pretreatment and ink by means of the heat press. ↗"5-3-1. Provisions for pretreatment >> P.5-5"
- Silicone foam (of open-cell structure)  
It is the foamed mattress which resists heat. Use this at a fixing stage through the use of the heat press.
- Adhesive roller  
Use these to remove lint from a T-shirt or debris from its surface.
- Water supply to the humidifier  
↗"1-5-2. Water supply >>P.1-19"



- T-shirt (printing medium)
  - 100% cotton
  - Polyester blended yarn fabric

<TIPS>

- Although it is advisable to use a 100% cotton T-shirt, some textiles cannot necessarily guarantee good printing quality even if they are made of 100% cotton or blended yarn. In particular, for a T-shirt made of new material, perform a printing test on it beforehand.
- Some textiles may leave noticeable imprints of the pretreatment after it is fixated. In that case, wash them away with water.
- Perform a printing test beforehand. Then, the following phenomena may occur:
  - The textiles may be discolored by the pretreatment and cannot be restored to the original color even if they are washed.
  - A deep-colored polyester blended yarn fabric dissolves dye, which may cause the white ink to change to a slightly different color.
  - Fabric material may turn yellow after the pretreatment is fixed.

## 1-4. Name and function of each component

### 1-4-1. Front part

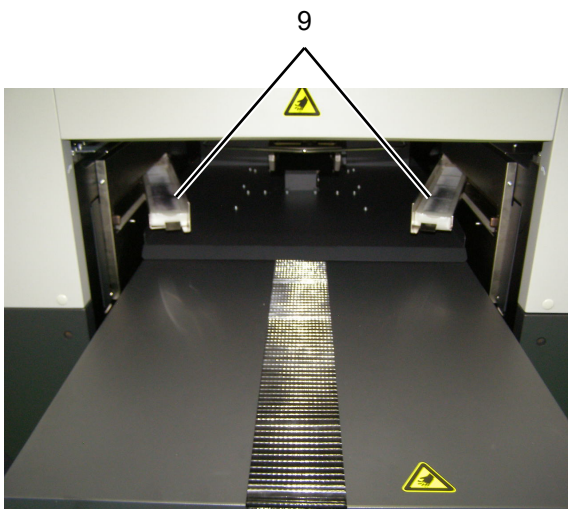
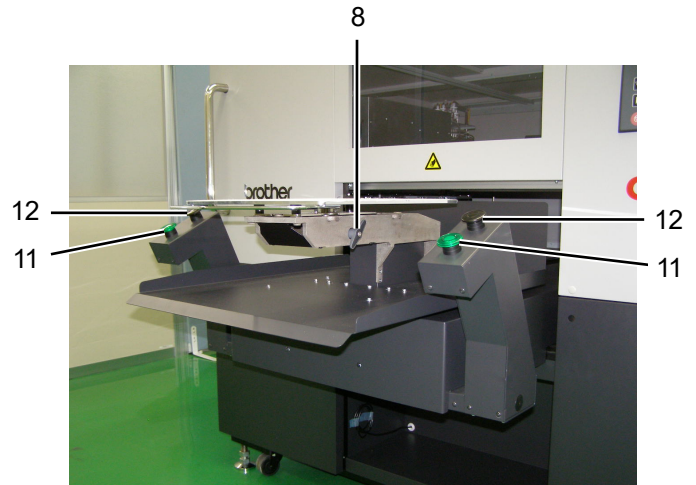
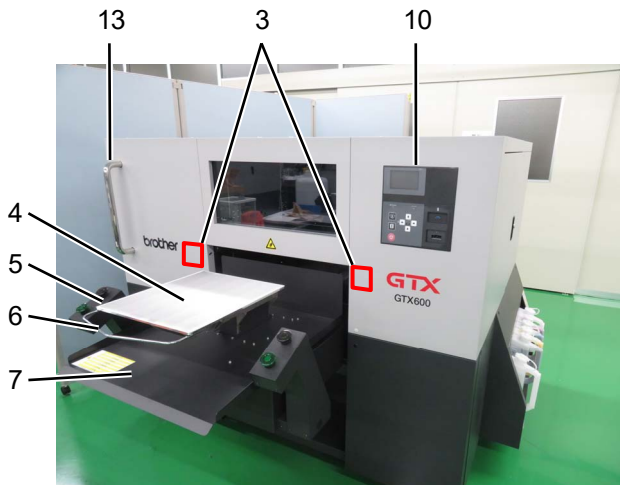
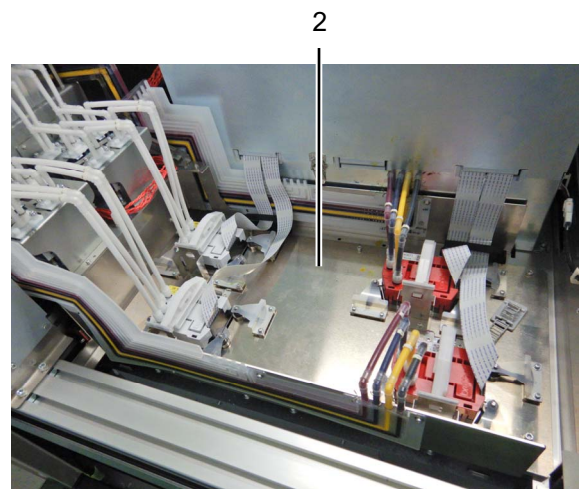
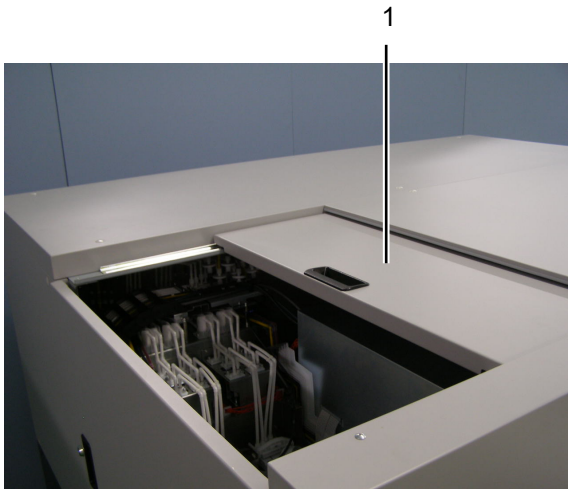

No.	Name	Function
1	Top cover	Open this cover when cleaning the internal area of the printer.
2	Carriage	Holds the print head.
3	Obstacle sensor	Checks the presence of any obstacles by their height (such as wrinkled T-shirt) that are within range to collide with the print head.
	“Platen too low” sensor	Make sure that the clearance between the head and platen is not too large.
4	Platen sheet	It helps to keep the T-shirt from moving/shifting during printing so that an image can be clearly printed.
5	Platen	Set the T-shirt to be printed.
6	Shoulder bar	Align the position of a T-shirt with this bar.
7	T-shirt tray	This T-shirt tray holds such portions of T-shirt that droop down on it and feeds the entire T-shirt into the printer.
8	Platen fixing handle	Use this handle to secure the platen in place. Tighten or loosen it when attaching/removing the platen. Keep it tightened when printing.
9	Mist fan filter	It absorbs ink mist which is generated inside the printer on its surface.
10	Operation panel	Operate the printer using this panel.
11	Print button	There is no print data when this button remains off. This button blinks during reception of print data, and it illuminates when such reception is completed. Printing will begin if you press this button when it is illuminated.
12	Stop button	Press either one to cancel operations, such as printing and platen movement. Printer will come to a stop after necessary actions for keeping the printer's good quality, such as retracting operation of print heads and capping operation, are completed.
13	Monitor mounting frame	You can mount the monitor by using the monitor arm.

## 1-4-2. Right side view

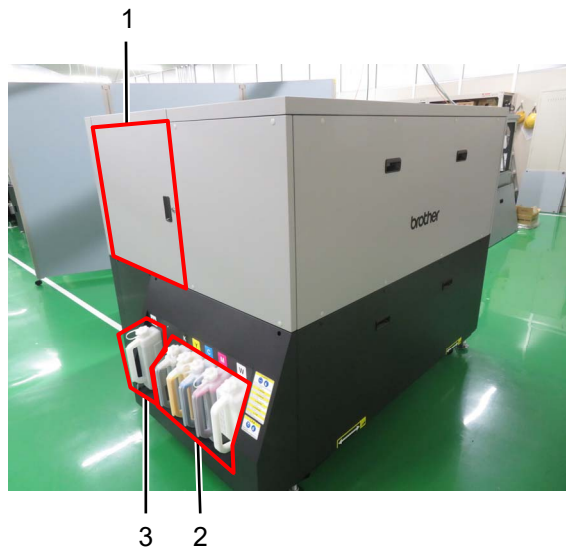

No.	Name	Function
1	Right side cover	Open this cover when cleaning the internal area of the printer.
2	Ink tank	White (W), magenta (M), cyan (C), yellow (Y), and black (K) from the right-hand side.
3	Cleaning solution tank	It is the tank that reserves the cleaning solution used for maintenance.

1-4-3. Left side view/Rear side view

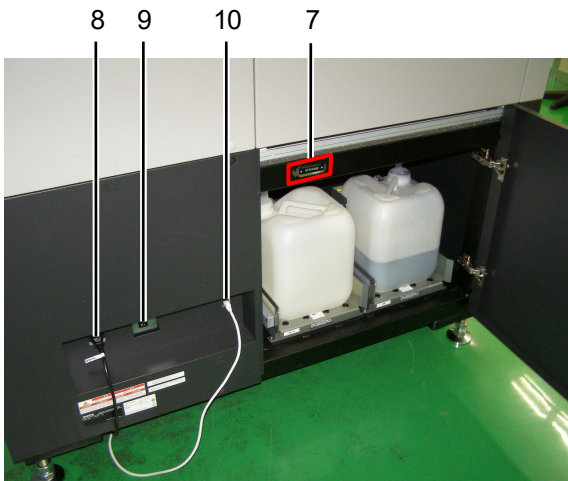
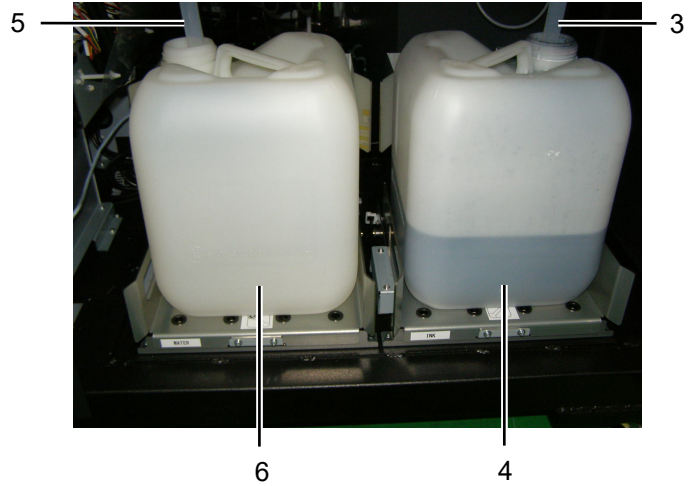

No.	Name	Function
1	Upper left side cover	Open this cover when cleaning the internal area of the printer.
2	Lower left side cover	Open the cover and replace the waste ink tank and waste water tank.
3	Waste ink tube	This tube is used to direct the flow of waste ink down into the waste ink tank.
4	Waste ink tank	This tank collects waste ink.
5	Drainage tube	This tube is used to drain water.
6	Waste water tank	This tank collects drain water.
7	Model plate	On this plate, a product serial number is inscribed.
8	Power cord insertion port	Insert the power cord into this port.
9	Power switch	Use this button to turn the power on/off to the printer. To turn off the power, execute [Prepare Power OFF] on the operation panel, and turn off the power switch after completing the operation.
10	LAN port	Into this port, insert the LAN cable which is to be connected with a PC.



### 1-4-4. Inside the cover

<IMPORTANT>



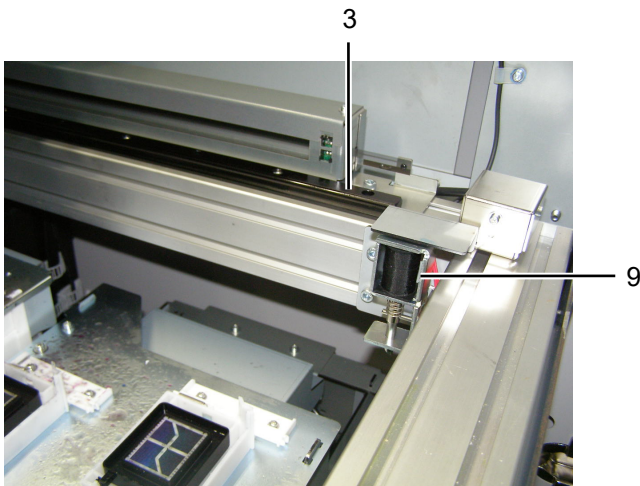
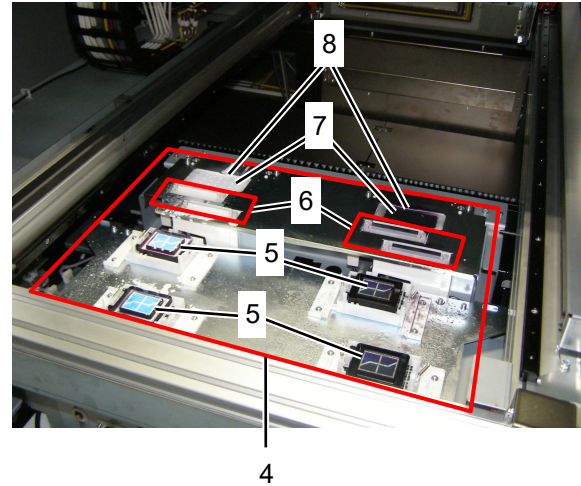
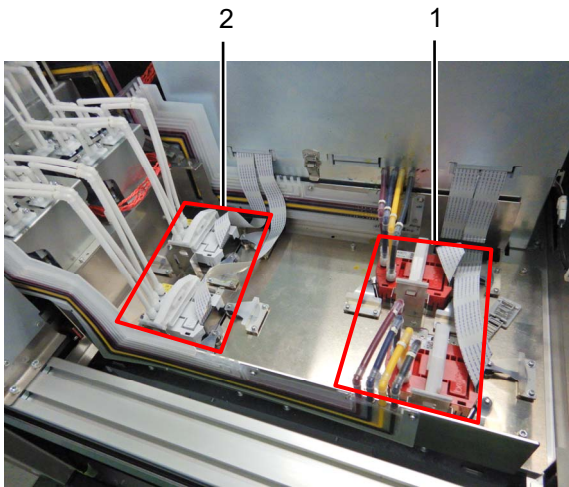

- If you put your hands inside the cover during regular maintenance while the power is on, follow the instructions in this manual.



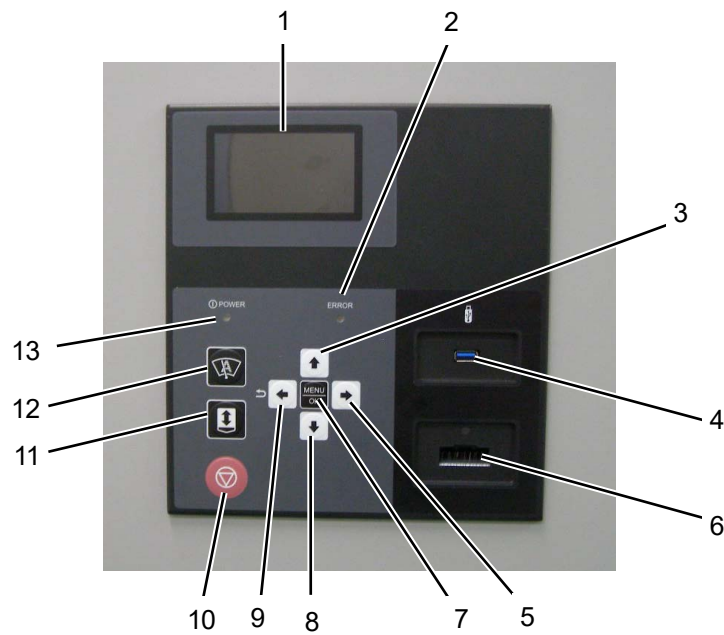

No.	Name	Function
1	Print head (front: on the color side)	It ejects the color ink.
2	Print head (rear: on the white side)	It ejects the white ink.
3	Carriage linear guide	This shaft supports the carriage.
4	Maintenance unit	In order to keep good printing quality, this unit performs maintenance functions to the print heads on a regular basis. (Example: Auto-Cleaning Function)
5	Caps (color, white)	The caps protect the color and white head surfaces and suck ink when cleaning the heads.
6	Wiper unit	It wipes away ink from the head surface.
	Wiper cleaning tank (Under the wiper unit)	This tank keeps cleaning solution and soaks and cleans the wiper.
7	Flushing foam	To keep good printing quality the foam absorbs the ink-jet droplets ejected from the print head.
8	Flushing receiver	Set the flushing foam.
9	Carriage locker solenoid	To prevent drying of print heads, it fixes the carriage to the cap position of the maintenance unit.
10	Carriage foam	It absorbs ink and prevents printed materials from being stained.

## 1-4-5. Operation panel



No.	Name	Function
1	Liquid crystal panel	It indicates the job name or file name of print data, the active status of the printer, and the menu for various settings.
2	Error LED	When it remains off: No error has occurred. When it remains on: One or more errors have been detected.
3	Up-arrow button 	While the menu screen is being displayed, use this button to select your desired menu item. In the numeric value setting menu, use this button to increase the target value.
4	USB flash insertion slot	Insert a USB flash memory into this slot.
5	Right-arrow button 	While the menu screen is being displayed, use this button to select your desired lower-level (right) menu item. While the standby mode screen is being displayed, use this button to display a warning when any warning message appears.
6	IC stick insertion slot	This slot accommodates the IC stick that contains the color information for use when refilling the ink.
7	MENU/OK button 	If this button is pressed when the printer is placed in the standby state, the menu screen will appear. While the menu screen or the error screen is being displayed, use this button to finalize and accept the currently displayed content.
8	Down-arrow button 	While the menu screen is being displayed, use this button to select your desired menu item. In the numeric value setting menu, use this button to decrease the target value.
9	Back button / Left-arrow button 	While the menu screen is being displayed, use this button to return to only one upper-level (left) menu screen. If this button is pressed when the printer is placed in the standby state, the printer status will be displayed.





No.	Name	Function
10	Stop button 	<p>With this button, such actions as printing and platen movement can be canceled.</p> <p>Printer will come to a stop after necessary actions for keeping the printer's good quality, such as retracting operation of print heads and capping operation, are completed.</p> <p>While the menu screen is being displayed, the screen will exit and return to the standby mode screen.</p>
11	Platen button 	<p>It is used to move the platen toward the rear or front of the printer. Use this button to ascertain whether the platen is set to a proper height after the platen's height is adjusted.</p>
12	Shortcut button 	<p>Performs the action assigned to the shortcut function.</p>
13	Power LED	<p>When it remains off: The power of the printer is turned off.</p> <p>When it remains on: The printer remains turned on (powered on).</p>

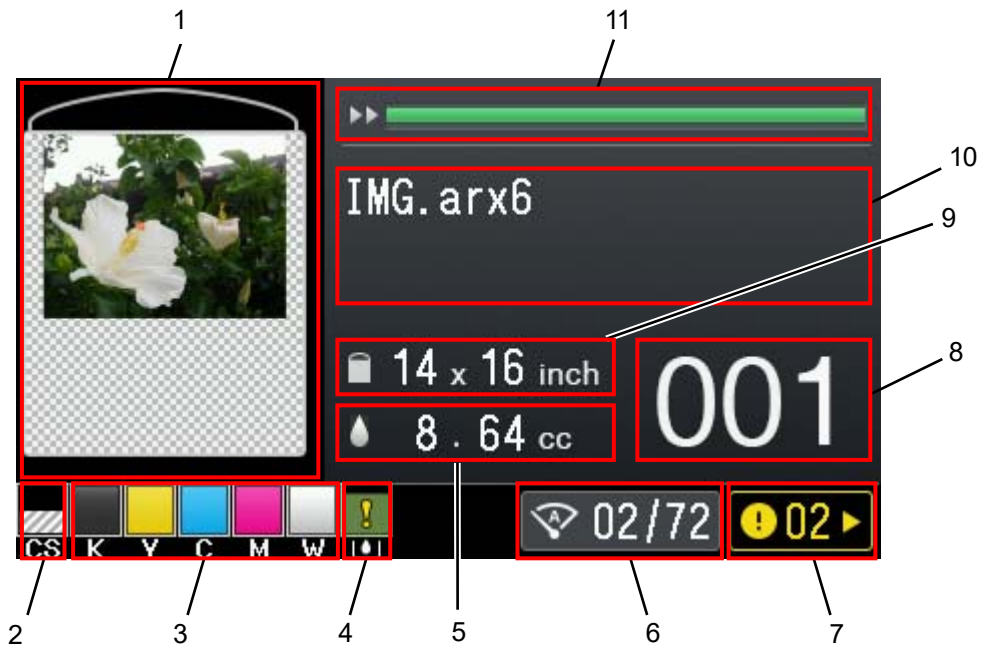

## Liquid crystal panel

The picture shown below indicates a state under which the printer has received print data. On this screen, the printer's current state and necessary information for printing are displayed.



No.	Indications	Function
1	Preview image	The preview display screen of received print data is shown in this window. The preview display screen shown here is indicated upside down as opposed to the page orientation (the upper side of the preview image is oriented toward the front of the printer main unit). Furthermore, it is possible to change the direction of the preview display screen as well.
2	Remaining cleaning solution volume indication area	In this area, the current remaining cleaning solution volume in the tank is displayed.
3	Remaining ink volume indication area	In this area, the current remaining ink volume of each tank is displayed. In the left-to-right order, the remaining ink volume in the black (K), yellow (Y), cyan (C), magenta (M), and white (W) ink cartridges are shown here.  : The remaining ink volume is running low. Make ink available for use in the next printing session. *1  : Ink has been depleted.
4	Waste ink tank replacement indication	This indication shows a guideline for replacing the waste ink tank.
5	Ink volume to be used	The required ink volume (cc) for printing out one sheet of the received print data is displayed here. (CMYK + White)
6	Auto-Cleaning	Head cleaning is automatically performed every time a predetermined number of sheets are printed in order to provide stable printing quality.
7	Warning mark 	This mark appears when any warning is issued. Pressing  causes the current screen to move to the warning screen where the applicable warning message is indicated.



No.	Indications	Function
8	Number of printed sheets	The total number of printed sheets of which printing operation is completed in response to the received print data is displayed here. (0 to 999)
9	Platen Size	Platen size that is specified by the printer driver during data creation is indicated here.
10	Text string display area on basic display screen	In this area, the print job name or file name, auto cleaning, receiving state, standby state, etc. are shown.
11	Progress bar display area	It displays a state of progress during the process of printing.

**<IMPORTANT>**

\*1: If you perform printing that requires a large volume of ink when the remaining ink level is low, the ink may be depleted during the printing process. As a rough indication, refill the ink before you perform printing that requires 20 cc or more ink.

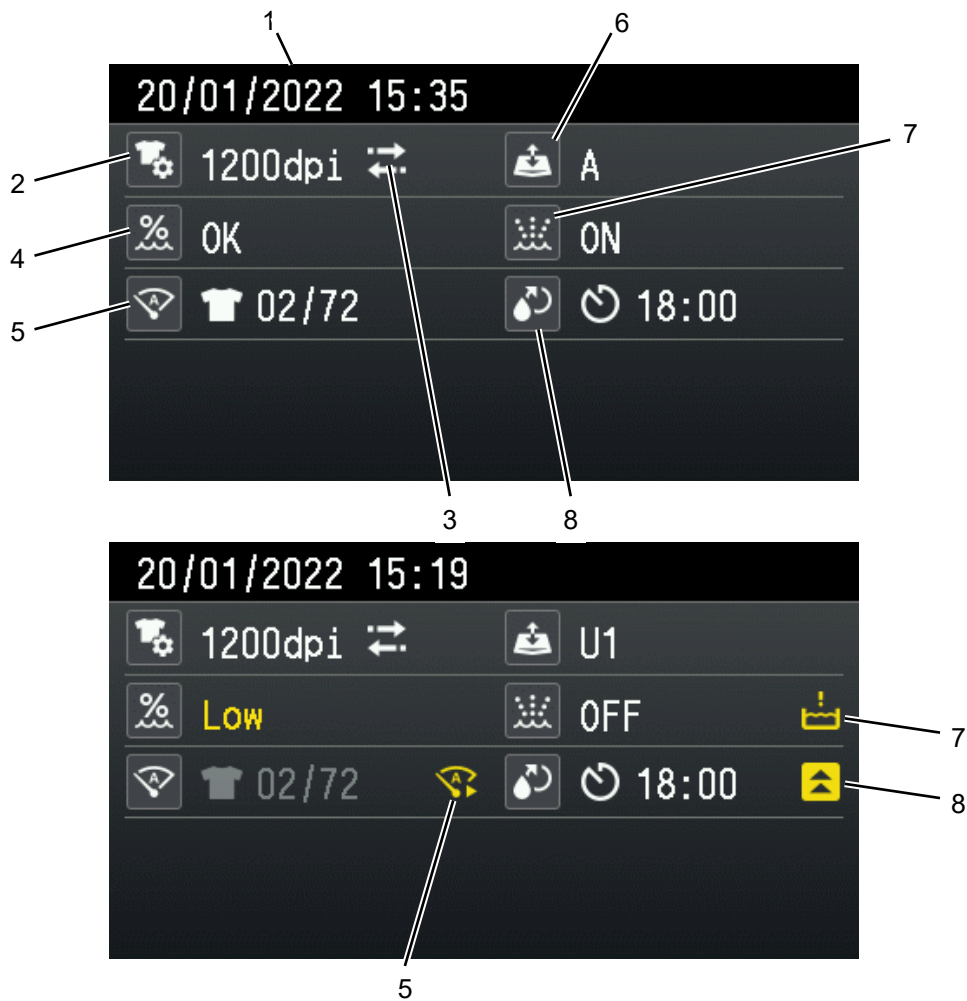
When receiving print data, press the left arrow button on the screen to switch it over to the following screen to display print information.



No.	Indications	Function
1	Time/Date	Displays the current date and time.
2	Resolution icon	The printing resolution of received print data is displayed here.
3	Print direction icon	The print direction is displayed here in the form of either bi-directional or the uni-directional icon.
4	Humidity display	The humidifier operates to keep the humidity of the unit between 65% and 75%. "Suitable" will be displayed if the humidity is appropriate, and "Low" will be displayed if it is less than 65%RH.
5	Auto-Cleaning	Head cleaning is automatically performed every time a predetermined number of sheets are printed in order to provide stable printing quality. At the next print,  will be displayed on the right side if auto cleaning is activated before or after printing. (The conditions for performing auto cleaning will change as appropriate depending on changes in temperature and humidity, the length of printing intervals, etc. Therefore, the presence or absence of auto cleaning may differ at the time of actual printing.)
6	Platen position	The current platen position is displayed.
7	Humidifier ON/OFF	The humidifier runs automatically. Therefore, you can see if it is currently running.  will be displayed on the right side when the waste water tank is filled with water.

No.	Indications	Function
8	White ink circulation time	The time of the next white ink circulation is displayed. The time set by the maintenance tool is displayed. The reinforced circulation of white ink will be performed if  is displayed.

## 1-5. About the humidifier

The humidifier works to maintain the image quality and keeps the humidity of the unit properly. Furthermore, the water accumulated inside the humidifier will be regularly discarded for hygiene control.

### <IMPORTANT>

- If the humidity inside the printer is low, the amount of ink consumed will increase to maintain the functionality of the printer.
- If excessive water is supplied to the humidifier, the water will be released through the hose on the lower right front side of the printer. Do not connect power cords on the floor near the printer. Doing so may result in electric shock.

### <TIPS>

- The humidifier will not operate if the ambient humidity is high and the humidity inside the unit is sufficiently high.

### 1-5-1. About the water used

Use pure water.

### <IMPORTANT>

- If non-pure water, such as tap water, is used, white powdery impurities will adhere to the inside of the unit, causing damage to the printer and heads.

### 1-5-2. Water supply

Select the water supply to the printer from the following two methods. Please refer to the Setup Manual for how to connect to the printer.

#### Optional items

- Water tank supply ASSY
- Water T6040 15M
- L-shaped fitting 06-06

#### Commercially available item

- Regulator
- Pure water equipment

#### Supply from a water pipe

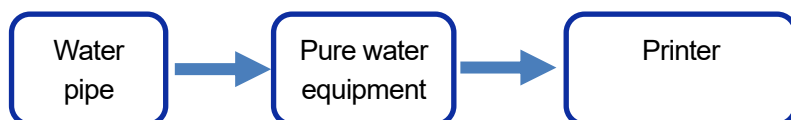

### <NOTE>

- If supplying water from a water pipe, perform piping according to the applicable laws and regulations.
- If necessary, use a regulator so that the supply pressure will be 0.2 MPa or less.



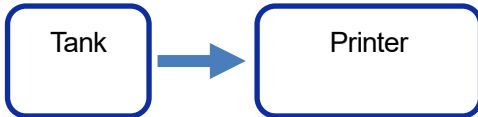





## Supply from a tank



### <IMPORTANT>

- Fill the tank with pure water.
- Use a clean container to supply water to the tank.
- Install the tank about 31.5 in. (80 cm) above the installation location of the printer.  
If the height is insufficient, water may not be supplied to the printer.
- The tube should be laid on the floor, and the length should be 49.2 ft. (15 m) or less. Piping should be done so that the height difference between the tubes is about 5.9 in. (15 cm).
- Limit the number of L-shaped fittings to three per flow path.
- Be sure to mount a cable cover with sufficient strength to the tube.  
Water will not be supplied and may leak to the floor if the tube is broken or cut off.
- Lay the tube so that the bending radius is 2.0 in. (5 cm) or more.  
If the bending radius is small, the tube may break.
- If the tube is broken during laying, do not use the broken part.
- Do not use the optional humidifier water supply tube to connect to tap water piping.
- Loosen the tank's cap during use.
- Verify that the faucet is in the closed position before inserting or removing the tube. Failure to do so could allow the water to flow out of the tank.
- Check inside the water supply tank once a month. Clean inside the tank if you notice any bad odor or discoloration.

## On-screen menu manipulation

What to do	How to operate
Start	Pressing  in the wait state causes the current screen to move to the menu selection screen.
Select / Acknowledge	<p>By means of  / , change a menu item to another menu item to be displayed.</p> <p>Pressing  causes the current menu to change to another menu item which is one level lower in the menu layer.</p> <p>Pressing  causes the currently displayed menu to be acknowledged.</p>
Return to previous menu in upper menu layer	Pressing  causes the current menu to change to another menu item which is one level higher in the menu layer.
Exit	<ul style="list-style-type: none"> <li>• If you press  when a menu in the uppermost menu layer remains displayed, the menu will exit and the system will return to a standby state.</li> <li>• If you press  when an optional menu remains displayed, the menu will exit and the system will return to a standby state.</li> </ul>

## Menu list

1st layer	2nd layer	3rd layer	Description
[Platen height adjustment]	[Position A]		This menu item is used to set the platen height.
	[Position B]		
	[Position C]		
	[Position D]		
	[Position E]		
	[Position F]		
	[Position G]		
	[Position H]		
	[User settings 1]		
	[User settings 2]		
[Head Cleaning]	[Normal Cleaning]	[All Colors]	In the event that no ink-jet droplets are ejected, this menu item enables you to perform cleaning of all the nozzles of the color heads.
		[All Whites]	In the event that no ink-jet droplets are ejected, this menu item enables you to perform cleaning of all the nozzles of the white heads.
		[All Print Heads]	In the event that no ink-jet droplets are ejected, this menu item enables you to perform cleaning of the nozzles of all the print heads.
	[Powerful Cleaning]	[All Colors]	In the event that the poor ejection of ink-jet droplets is not improved by means of the normal cleaning, use this menu item.
		[All Whites]	
		[All Print Heads]	
	[Super Cleaning]	[All Colors]	In the event that the poor ejection of ink-jet droplets is not improved by means of the powerful cleaning, use this menu item.
		[All Whites]	
		[All Print Heads]	



1st layer	2nd layer	Description
[Test Print]	[Nozzle Check CMYK]	This is the test pattern to check to see if ink-jet droplets are ejected from the color heads properly or not.
	[Nozzle Check White]	This is the test pattern to check to see if ink-jet droplets are ejected from the white head(s) properly or not.
[Ink refill]	[Black]	Use when refilling the ink.
	[Yellow]	
	[Cyan]	
	[Magenta]	
	[White]	
	[Cleaning solution]	
[Print Data Load]		Any print data stored in a USB flash memory (ARX6, ARXP, or ARX4 file) is loaded into the system with this menu item.
[Receiving History]		By selecting this menu item, you can display any print data received in the order in which they are sorted from the newest to the oldest ones, and you can select any one of them.
[Maintenance]	[Maintenance Part Clean/Replace]	Use when performing printer maintenance.
	[White Ink Circulation]	
	[White Ink Tank Agitation]	
	[Humidification]	
	[Humidifier Water Replacement]	
	[Humidifier Initial Water Supply]	
	[Waste Ink Tank Disposal]	
	[Humidifier Drain Tank Disposal]	
	[Tank remaining volume sensor correction]	
	[Wiper Cleaning Tank Operation]	
	[Head Replacement]	
	[Install Ink after Replacing Head]	
	[Initial Ink Installation]	
	[Tube air bleed]	
	[Cap pump check]	
	[Log copy to USB]	

1st layer	2nd layer	Description
[Printer Setting]	[Print Direction]	Use when configuring the printer.
	[Back Light]	
	[Auto Screen Erase Time]	
	[Menu TimeOut Setting]	
	[Speaker Volume]	
	[Temperature]	
	[Preview display settings]	
	[File name display setting]	
	[Platen Setting]	
	[Low Temperature Mode]	
	[Low Humidity Mode]	
	[Post-circulation Auto Cleaning]	
	[Auto Cleaning Setting]	
	[Auto Cleaning Start Timing]	
	[Auto Multiple Pass Setting]	
	[Flushing Interval Setting]	
	[Flushing Volume Setting]	
	[Auto Job Delete]	
[Network filtering]		
[IP Address Set]		
[Shortcut button setting]		
[Total Print]		Use when needed.
[Temperature/Humidity Info]		
[Confirm network setting]	[IP Address]	
	[Subnet Mask]	
	[Default Gateway]	
	[Host name]	
	[MAC address]	
[Check circulation schedule]		
[Check humidification schedule]		
[Language]		
[Prepare Power OFF]		
[Version]	[Firm Version]	
	[Data Info]	
	[Serial No.]	
	[Head information]	

Be sure to use the printer after making correct setting in accordance with the instructions described in this chapter.

## WARNING



Do not set up the printer in a dusty environment. If dust collects inside the printer, it may cause fire or electric shocks or problems with correct operation.



Be sure to connect the ground. If the ground connection is not secure, you run a high risk of receiving a serious electric shock, and problems with correct operation may also occur.



Do not bend the cords excessively or fasten them too hard with staples or anything similar to secure cords. Otherwise it may cause fire or electric shocks.



## CAUTION



The printer machine weighs 730 kg (1609 lb). Transporting and setting up of the printer should be held in the proper way. Otherwise, the printer may topple over and cause injury.



Unplug the printer and contact the dealer where you purchased the printer or a trained technician if the printer topples over. If you continue to use it, it may result in fire or electric shocks or poor printing quality.



Do not set up the printer in a place where it will be affected by vibration. Otherwise the printing quality may be degraded or the printer may topple over, which causes injury or results in failure of the printer.



Do not connect the power cord until installation is complete. The printer may operate if the power switch is turned on by mistake, which could result in injury.



Do not climb onto the printer or place heavy objects on top of it. You may get injured if it becomes unbalanced and tips over.

### 3-1. Installation of printer

Please refer to the Setup Manual included with the printer, for details of unpacking procedures and installation procedures of accessories.

For an installation site of the printer, please bear the following points in mind:

- When installing the printer, avoid any place that presents direct sunlight or a large amount of dust.
- The size is 66.5 in. (width) x 69.3 in. (depth) x 63.0 in. (height) (169 cm (width) x 176 cm (depth) x 160 cm (height)). The main unit weighs 730 kg (1609 lb).
- Do not use any extension cable.
- Keep a minimum workspace of 31.5 in. (80 cm) in front and on the left and right sides of the printer. Also, keep 15.7 in. (40 cm) or wider clearance at the back of the printer. Keep 17.7 in. (45 cm) or wider space free above the unit as well. If this space is not secured, you will have to move peripherals or the printer when making a repair.
- When installing the printer, place a level gage on the top surface of the platen to make adjustments so that the main unit is set horizontally level.

Printer installation dimensions

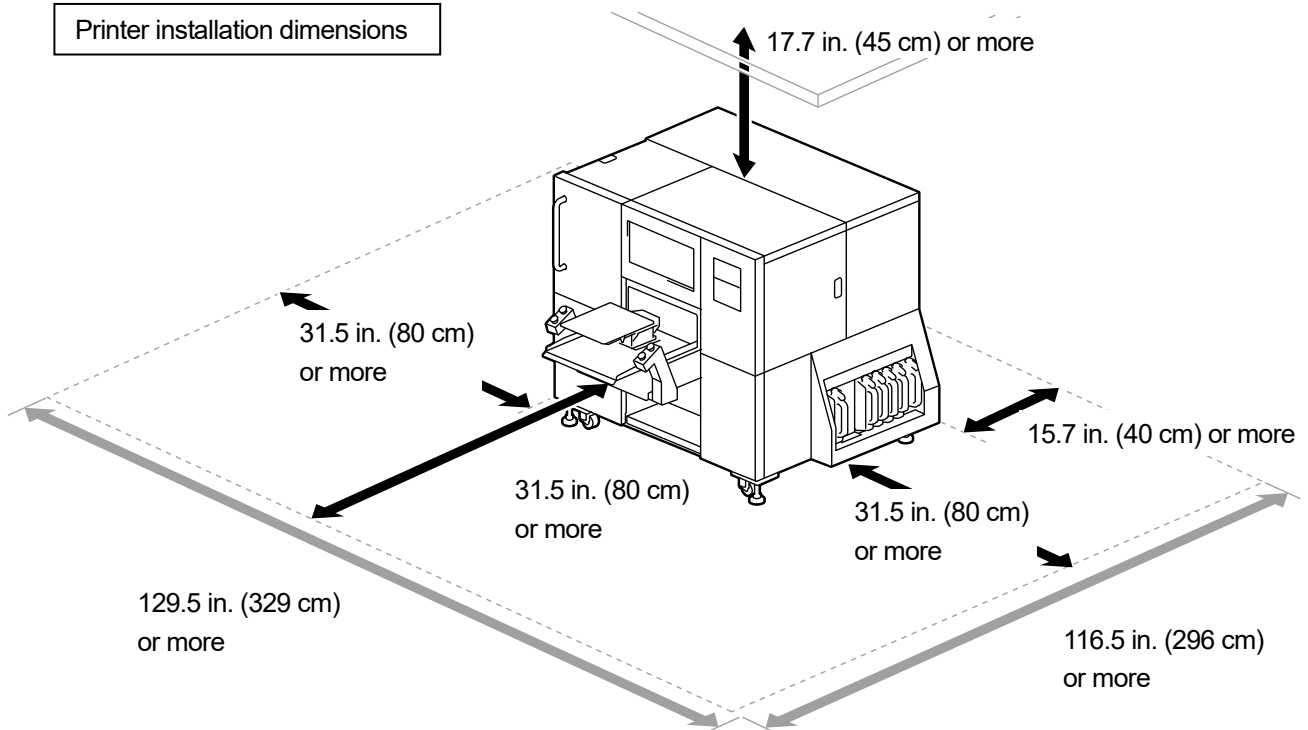

X1008

## 3-2. Initial installation of printer

Please refer to the Setup Manual for the following initial installation procedures:

- Main tank unit
- Print switch
- Waste ink tank/Waste water tank
- Humidifier pipe
- Carriage belt tension adjustment
- Humidifier water supply tube
- Water supply tank (optional item)
- Turning on the power

### 3-2-1. Level adjustment

Prepare a level gage and a 1.4-in. (35-mm) wrench.

- (1) On the operation panel, press , and move the platen toward the front of the printer.
- (2) Place a level gage on the top surface of the platen.

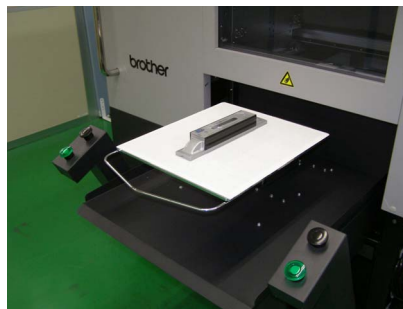
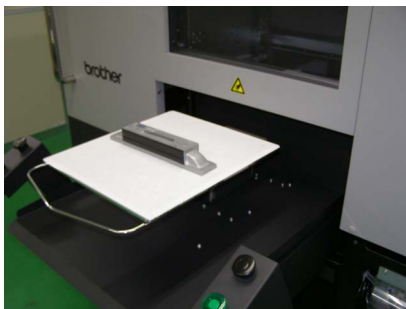

- (3) Adjust the level by rotating the lower nuts that secure the legs (4 points) so that the main unit is set horizontally level while checking the level gage.

<IMPORTANT>

- Adjust so that the adjusters protrude 4.9 in. (125 mm) or less from the bottom of the frame.

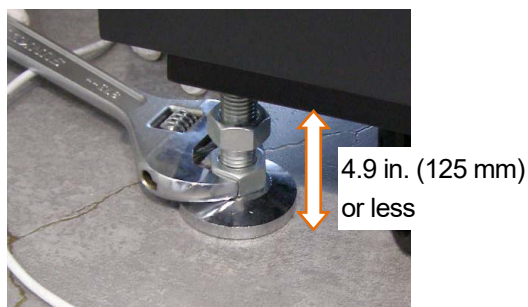

- (4) Tighten the upper nuts on the lefts (4 points) upwards after adjusting the level.



<IMPORTANT>

- Check the level again with a level gage after fixing everything.

### 3-3. Power supply of printer

Even when the printer is placed in standby mode, such maintenance as white ink circulation is performed automatically.  
**PLEASE LEAVE THE PRINTER POWERED ON 24 HOURS A DAY.**

#### <IMPORTANT>

- Do not turn off the power because if you do so, the machine may fail because necessary maintenance operations are not performed.

#### 3-3-1. Turning on the power

Please refer to the Setup Manual, after the unpacking procedures and installation procedures are completed.  
 Please check the following points, before connecting the power cord to the printer:

- Ascertain whether the ink tube is connected to the print head correctly.
- Ascertain whether the waste ink tube is inserted into the waste ink tank and waste water tank that have been made available.
- Ascertain whether at least about 31.5 in. (80 cm) of space required for the platen is secured.

#### <IMPORTANT>

- Turn on the power before you refill the ink.

- (1) Connect the power cord to the power cord insertion port.
- (2) Insert the power plug into an electric outlet.
- (3) Make sure that the printer's earth terminal is properly grounded.
- (4) Turn on the printer power switch with each door and cover closed.

#### <IMPORTANT>

- Never power off the printer while it is in operation. Otherwise, the printer may be damaged.
- Do not activate the printer with the ink tube not connected to the print head. Otherwise, the printer may be damaged.
- Make sure that no flushing foam extends off the outboard end portions of the flushing foam. If it sticks out of the end portions, it may interfere with any nozzles and may result in non-ejection of ink-jet droplets.

#### <TIPS>

- If the printer is activated after having been off for a long time, the maintenance operation including white ink agitation will be performed for up to 4 hours, depending on how long the power was off.

Power switch

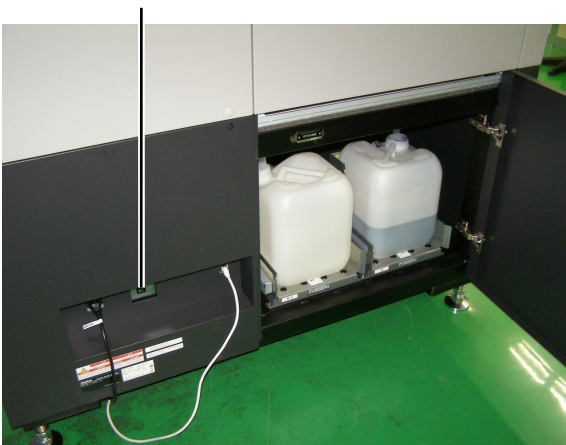

## 3-3-2. Turning off the power

---

### When you need to turn off the power

Turn off the power in the following cases.

- When moving the printer elsewhere.
- In the event that the power supply interruption is anticipated in advance, including the case where a planned power outage is scheduled.

### How to turn off the power

- (1) From the menu, select [Prepare Power OFF] and press  .

If the printer is operating, wait for it to finish.

- (2) Cleaning will start at the end of the print job.

Follow the instructions on the panel and turn off the power.

#### <IMPORTANT>

- No cleaning will be performed at the end of the print job to keep the print heads in good condition if you turn the power off or disconnect the AC power cable before the operation of [Prepare Power OFF] is completed. In these cases, the print heads may fail to eject ink-jet droplets. For this reason, be sure to activate the printer once again and perform the head cleaning after activation.



### 3-3-3. When there is no prospect of electric power recovery for a while due to power outage

Print head capping will be performed to prevent the print heads from drying out if there is a power failure while the printer is operating and no prospect of recovery for a while.

<IMPORTANT>

- Be sure to turn off the power switch before starting work.

<TIPS>

- Perform the work specified below when no print heads are capped, e.g., when a power failure occurs during printing. The specified work is not required if the print heads are capped.

- (1) Unlock the upper left-hand-side cover and top cover and open them.

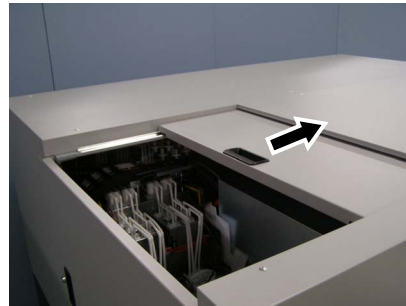
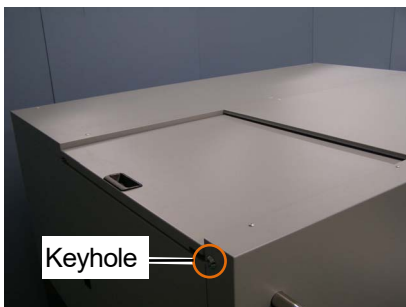

- (2) Remove two screws to remove the cover.

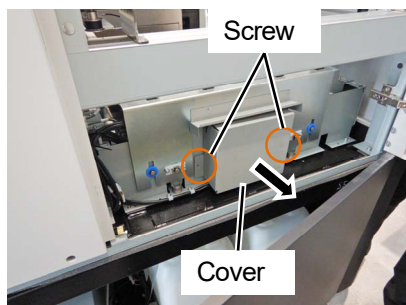

- (3) Place the cap fixing plate stored on the lower right side of the maintenance unit on the frame, and move the carriage toward you until the carriage comes in contact with the cap fixing plate.

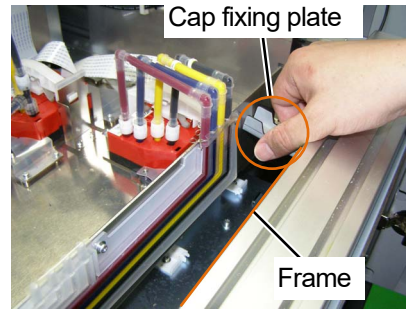
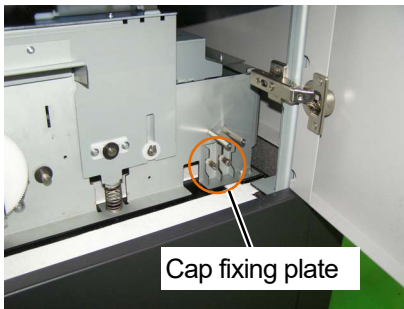

<IMPORTANT>

- Be careful not to let the carriage come in contact with the protrusion on the cap.
- Return the parts to the storage position.

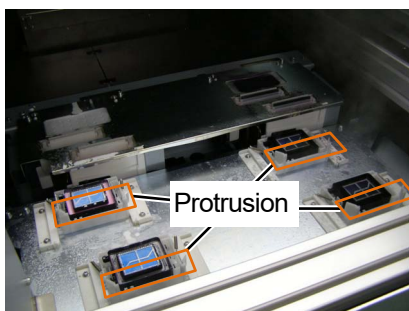

- (4) Insert the two pins stored on the lower right side of the maintenance unit into the holes marked A and B, respectively.

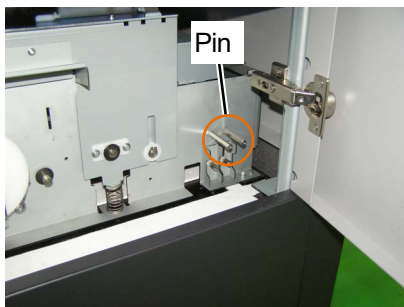

- (5) Turn the lever clockwise until it comes in contact with the pin inserted in A.

<IMPORTANT>

- If any print head rises, unlock and reinstall the print head.

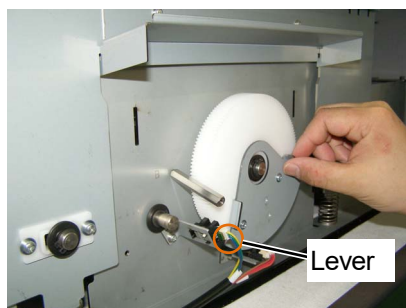

- (6) Push the carriage in the maintenance direction after the carriage comes in contact with the lever.

<IMPORTANT>

- Make sure that the protrusion on the cap touches the side of the print heads when pressing the carriage in the maintenance direction. Non-ejection may occur if the carriage comes in contact with the nozzle surface of a print head.

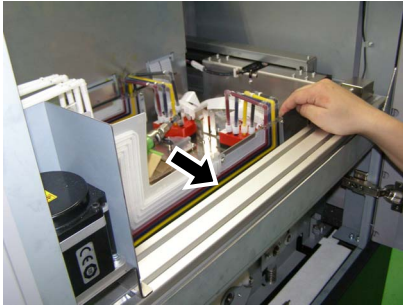

- (7) Pull out the pin inserted in A and turn the lever clockwise until the lever comes in contact with the pin inserted in B.

Print head capping will be performed correctly in this state.

<IMPORTANT>

- Make sure that the lever will not come in contact with the nozzle surfaces of the print heads when turning the lever.
- A print head may rise if you press the protruding part of the cap strongly against the nozzle surface of a print head. Do not forcibly turn the lever in that case, and start over the work from the beginning.



- (8) Pull out the pin inserted in B and attach the cover with the two screws.

<TIPS>

- Return the pins to the storage position.

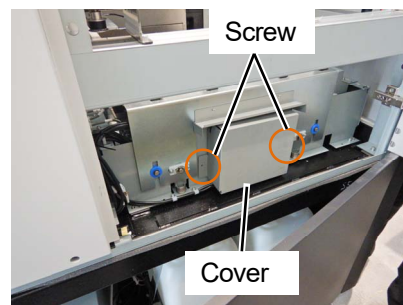

- (9) Turn on the power and restart the printer as soon as the power failure is restored.

<IMPORTANT>

- For this reason, be sure to restart the printer and perform the head cleaning after activation.

### 3-4. Connection between Printer and PC (for Windows)

This chapter provides information about the procedures to install the GTX-6 printer driver onto your PC and connection method of the printer to PC.

Proceed with the next step while checking each procedural step.

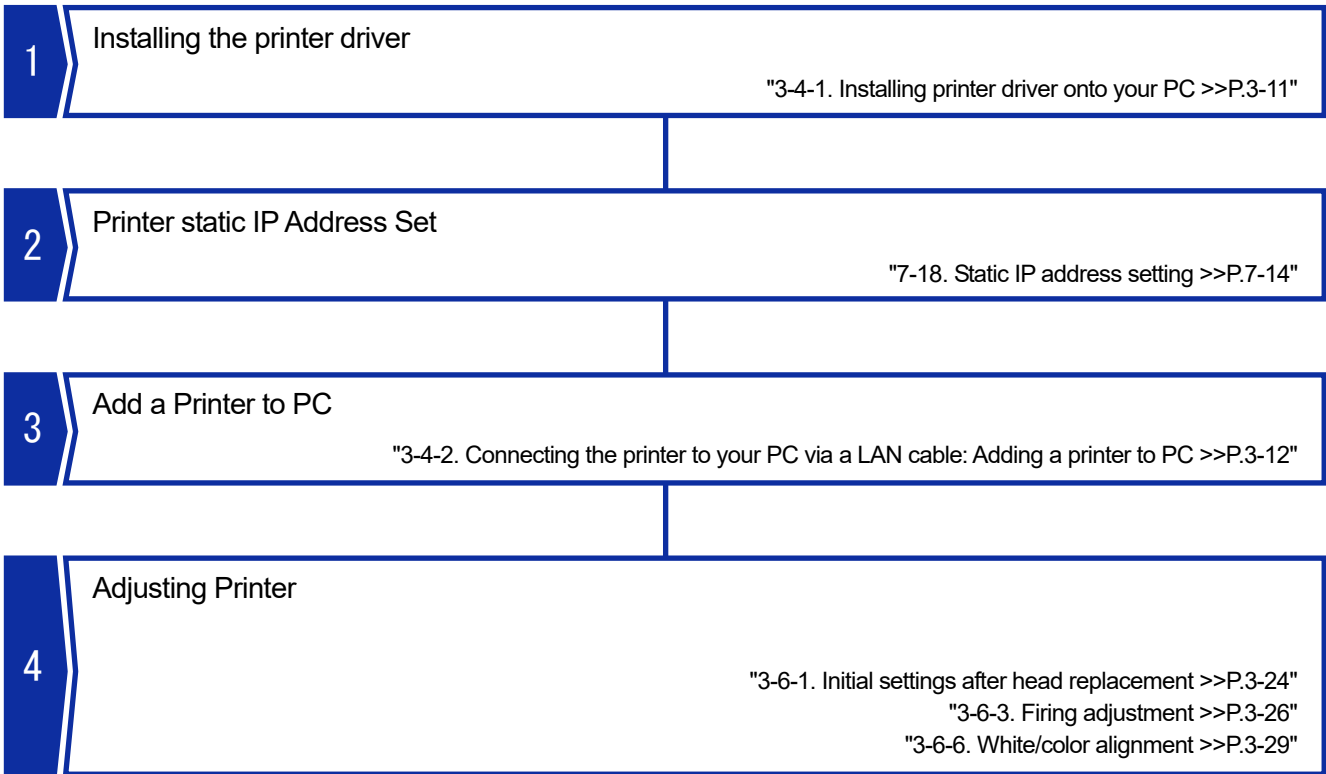

X1062

### 3-4-1. Installing printer driver onto your PC

To begin with, on your PC, install the printer driver for file output, "Brother GTX-6 FileOutput".  
At this stage, do not connect the printer to the PC yet.

<TIPS>

- You must log into your PC with administrator privileges.

- (1) Activate the PC.
- (2) Complete all of the current sessions.
- (3) Double-click on the "setup.exe" to execute the installer.
- (4) Then, the installation procedures will begin. Follow the on-screen instructions to complete the installation.
- (5) When the dialog box shown below appears, click [Install].

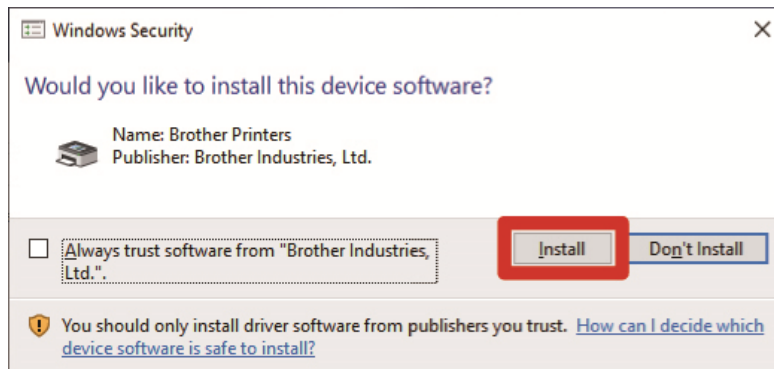

- (6) After the installation is completed, reactivate the PC.

### 3-4-2. Connecting the printer to your PC via a LAN cable: Adding a printer to PC

Before connecting via LAN, refer to "7-18. Static IP address setting >>P.7-14" and set the IP address for the printer. Then, add the printer to your PC according to the procedure specified below.

- (1) Connect your PC with the printer by means of the LAN cable to make a network connection, and power on the printer.

<TIPS>

- For this connection of the LAN cable, secure it in place by means of the cable clamp as required.

- (2) Select [Settings] > [Devices] > [Devices and Printers].
- (3) Click the [Add a printer].

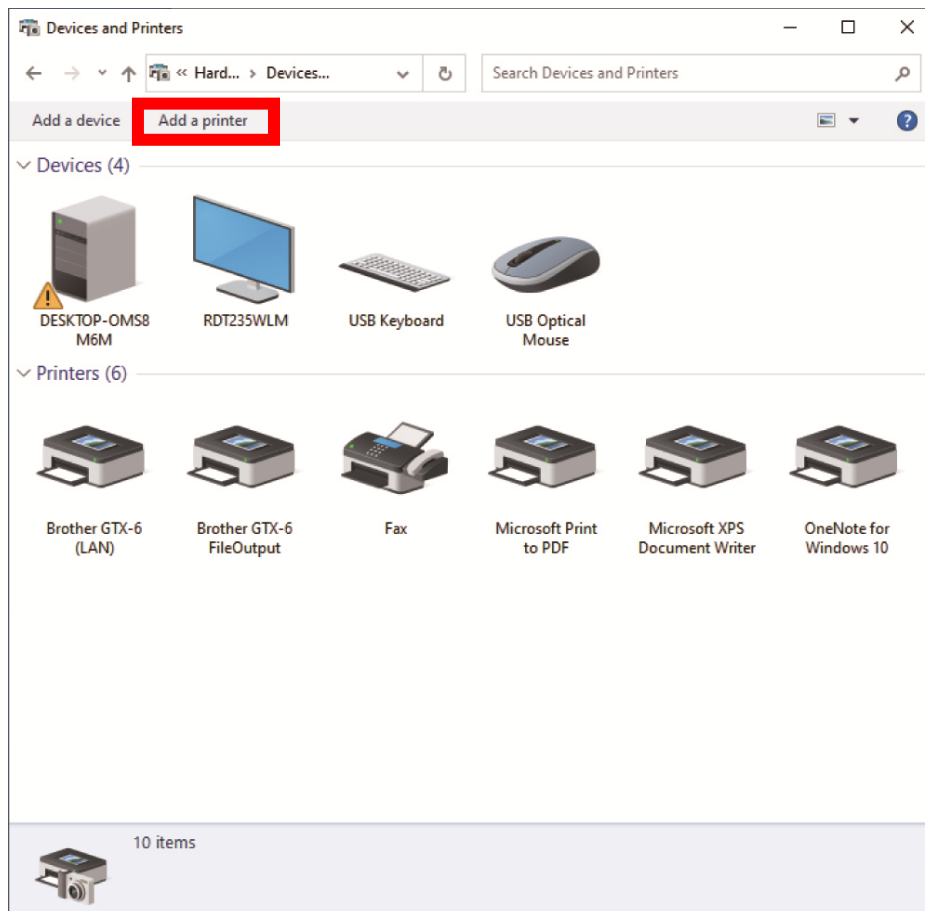

- (4) Select [The printer that I want isn't listed].

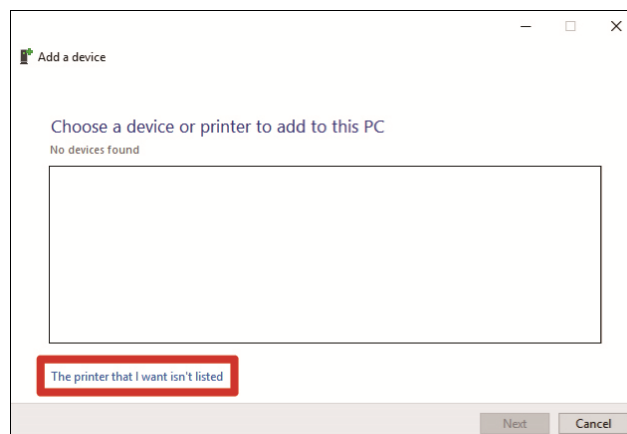

- (5) Select [Add a local printer or network printer with manual settings], then click [Next].

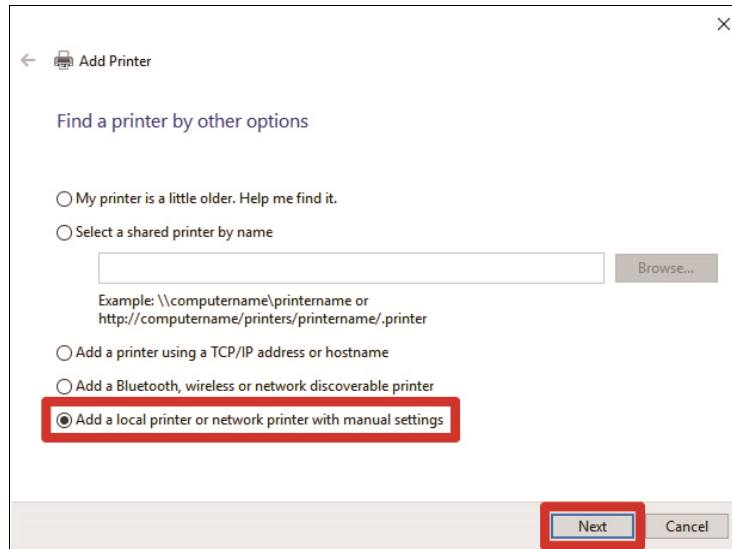

- (6) Select the [Create a new port], then select [Standard TCP/IP Port] for [Type of port], and finally click [Next].

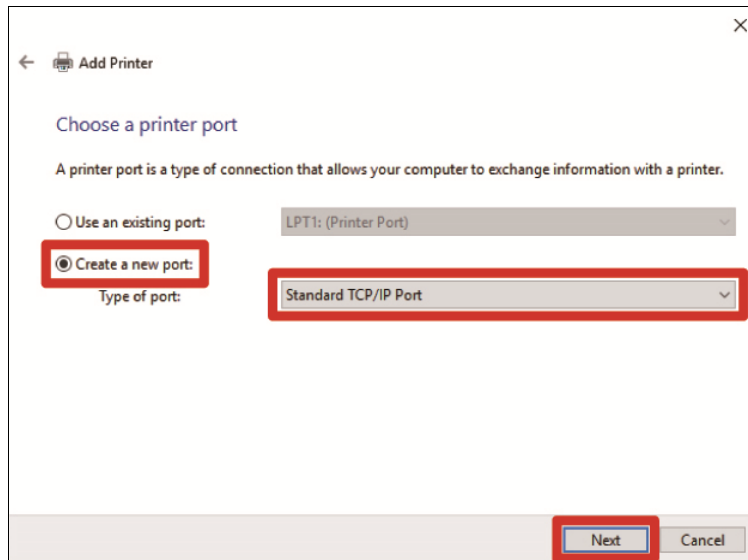

- (7) In the [Hostname or IP address] field, enter the already-setup static IP address of the printer, make sure that [Query the printer and automatically select the driver to use] is checked, and click [Next]. (One instance of each value is cited as shown in the window below.)

The screenshot shows the 'Add Printer' window with the following details:

- Title: Add Printer
- Instruction: Type a printer hostname or IP address
- Device type: TCP/IP Device
- Hostname or IP address: 192.168.0.2
- Port name: 192.168.0.2
- Checkbox:  Query the printer and automatically select the driver to use
- Buttons: Next, Cancel

#### <TIPS>

- You can omit steps (8) through (13) if the printer driver to use is automatically selected. Follow the steps if it cannot be selected automatically.
- If you set the printer's IP address by automatic acquisition, you must check the IP address of the printer in advance. You can confirm the IP address by selecting [Confirm network setting] -> [IP Address] from the menu. ④"7-22. Confirm network setting >>P.7-17"
- If you are using a DNS server, you can use a host name and domain name instead of the IP address. Enter the host name of your choice. ④"7-22. Confirm network setting >>P.7-17" As for the domain name, check with your network administrator.

- (8) Then, the detection window of TCP/IP port appears, and the current window will automatically go to the additional port information window after the detection is completed.
- (9) After the window shown below appears, select the [Custom] in the [Device Type], and click [Settings].

The screenshot shows the 'Add Printer' window with the following details:

- Title: Add Printer
- Section: Additional port information required
- Message: The device is not found on the network. Be sure that:
- List:
  1. The device is turned on.
  2. The network is connected.
  3. The device is properly configured.
  4. The address on the previous page is correct.
- Text: If you think the address is not correct, click Back to return to the previous page. Then correct the address and perform another search on the network. If you are sure the address is correct, select the device type below.
- Device Type:
  - Standard
  - Generic Network Card
  - Custom (Selected)
- Buttons: Settings..., Next, Cancel



(10) In the [Protocol], select the [LPR], enter "BINARY\_P1" in [Queue Name] of the [LPR Settings], and click [OK].

When the current screen goes back to the previous screen, click [Next].

Configure Standard TCP/IP Port Monitor

Port Settings

Port Name: 192.168.0.2

Printer Name or IP Address: 192.168.0.2

Protocol

Raw  LPR

Raw Settings

Port Number: 9100

LPR Settings

Queue Name: BINARY\_P1

LPR Byte Counting Enabled

SNMP Status Enabled

Community Name: public

SNMP Device Index: 1

OK Cancel

(11) After the window shown below appears, click the [Have Disk].

Add Printer

Install the printer driver

Choose your printer from the list. Click Windows Update to see more models.  
To install the driver from an installation CD, click Have Disk.

Manufacturer

Printers

Brother GTX-6

This driver has an Authenticode(tm) signature. [Tell me why driver signing is important](#)

Windows Update Have Disk...

Next Cancel

- (12) Click the [Browse], select the "64bit\_OS" folder in the installer according to the PC's OS (64 bit version).

After the file path appears, click [OK].

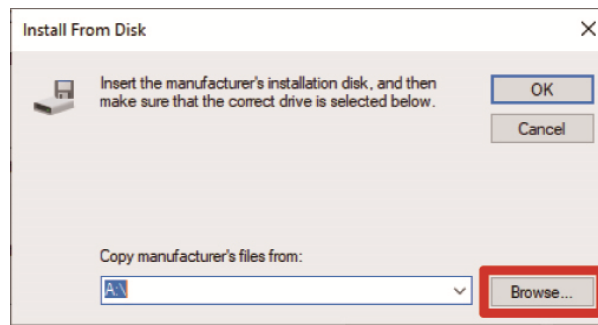

- (13) Make sure that a list of printer drivers is shown for the selected folder.

After that, click [Next].

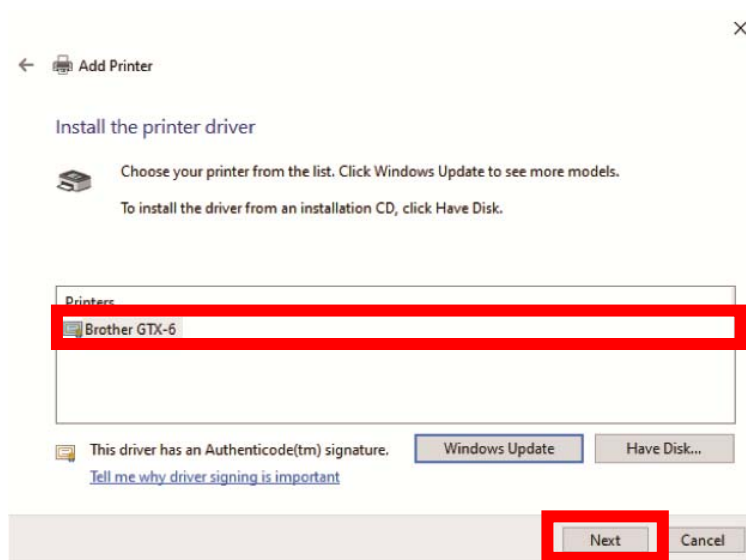

- (14) After the window shown below appears, select the [Replace the current driver], and click [Next].

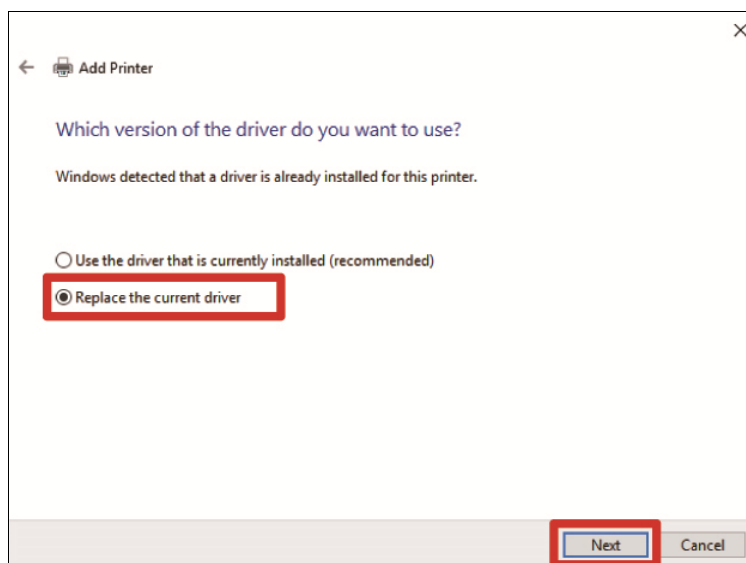

(15) Enter [Printer name], and click [Next].

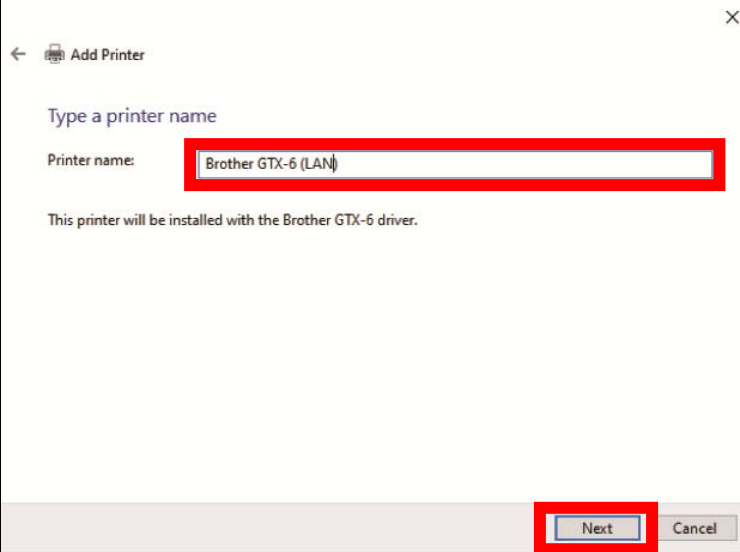

The screenshot shows a Windows 'Add Printer' dialog box. The title bar reads 'Add Printer'. Below the title bar, there is a back arrow and a printer icon. The main text says 'Type a printer name'. Underneath, the 'Printer name:' label is followed by a text input field containing 'Brother GTX-6 (LAN)'. Below the input field, it says 'This printer will be installed with the Brother GTX-6 driver.' At the bottom right, there are two buttons: 'Next' and 'Cancel'. Both the input field and the 'Next' button are highlighted with a red rectangular box.

(16) Then, the specified printer will be added to the system, following which the window shown below appears, select the [Do not share this printer], and click [Next].

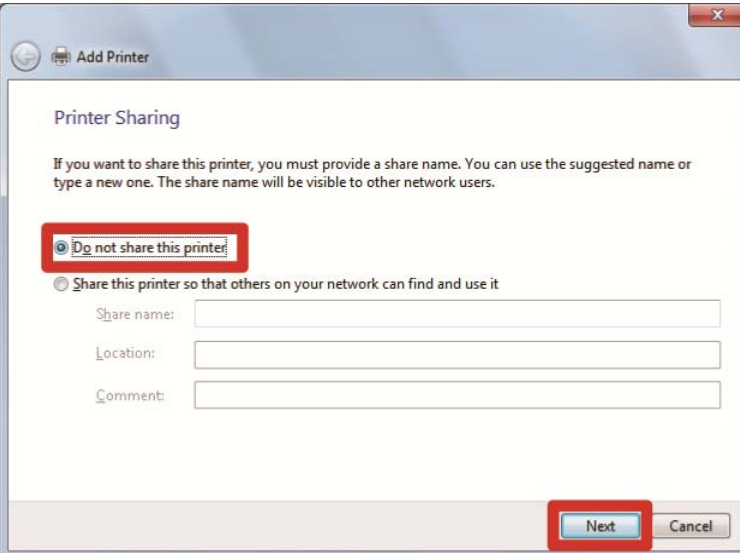

The screenshot shows a Windows 'Printer Sharing' dialog box. The title bar reads 'Add Printer'. Below the title bar, there is a back arrow and a printer icon. The main text says 'Printer Sharing'. Below that, it says 'If you want to share this printer, you must provide a share name. You can use the suggested name or type a new one. The share name will be visible to other network users.' There are two radio button options: 'Do not share this printer' (which is selected and highlighted with a red box) and 'Share this printer so that others on your network can find and use it'. Below the second option, there are three text input fields labeled 'Share name:', 'Location:', and 'Comment:'. At the bottom right, there are two buttons: 'Next' and 'Cancel'. The 'Next' button is highlighted with a red rectangular box.

(17) Click [Finish]. This exits the setting for the PC.

<TIPS>

- If the PC cannot recognize the Printer, a correct static IP address might not be assigned. Consult your administrator.

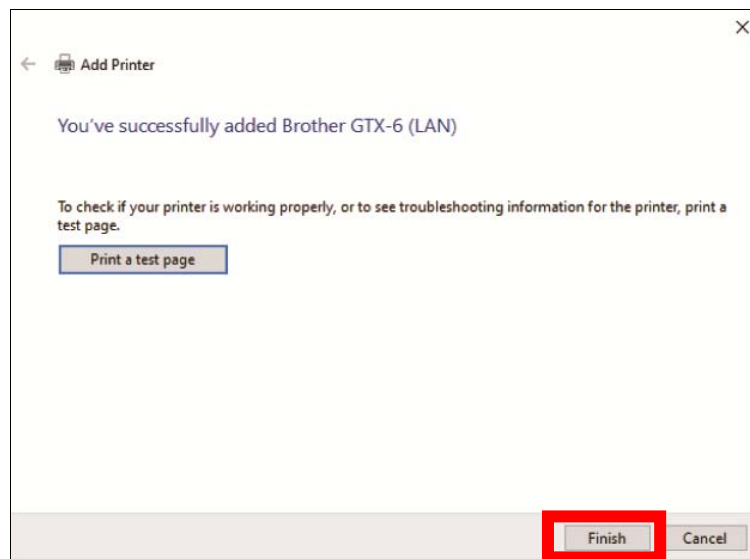

(18) Then adjust the printer using "GTX-6 Maintenance".

## 3-5. Connection between Printer and PC (for Macintosh)

This chapter provides information about the procedures to install the GTX-6 printer driver onto your PC and connection method of the printer to PC.

### 3-5-1. Installing printer driver onto your PC

---

To begin with, on your PC, install the printer driver for file output, "Brother GTX-6 FileOutput".

At this stage, do not connect the printer to your PC yet.

<TIPS>

- You must log into your PC with administrator privileges.

- (1) Activate the PC.
- (2) Complete all of the current sessions.
- (3) Double-click on "BrotherGTX-6\_ver\*\*\*.pkg" to execute the installer.
- (4) Then, the installation procedures will begin. Follow the on-screen instructions to complete the installation.
- (5) After the installation is completed, reactivate the PC.

### 3-5-2. Connecting the printer to your PC via a LAN cable

Before connecting via LAN, refer to ["7-18. Static IP address setting >>P.7-14"](#) and set the IP address for the printer. Then, add the printer to your PC according to the procedure specified below.

- (1) Connect your PC with the printer by means of the LAN cable to make a network connection, and power on the printer.

<TIPS>

- For this connection of the LAN cable, secure it in place by means of the cable clamp as required.

- (2) Open [System Preferences] from the Apple menu and click [Printers & Scanners].



- (3) Click the + button at the bottom left.



- (4) Select [IP].

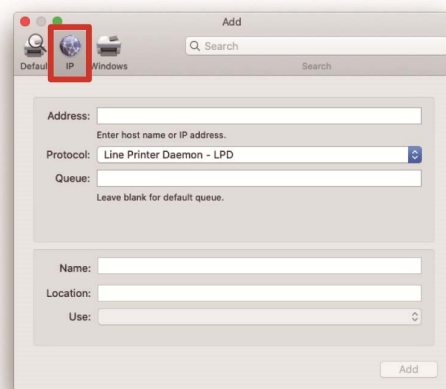

- Enter the IP address of the printer for [Address].  
Select [Line Printer Daemon - LPD] from [Protocol].  
Enter "BINARY\_P1" for [Queue].  
Enter the printer name for [Name].  
Select and click [Select Software...] under [Use].

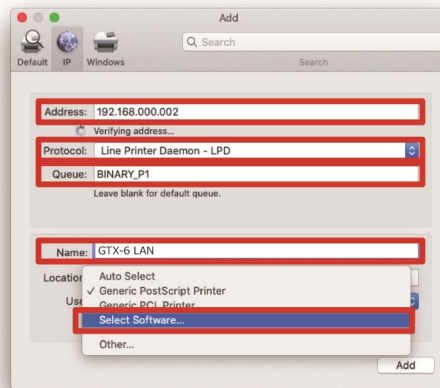

- Select [Brother GTX-6] and click [OK].

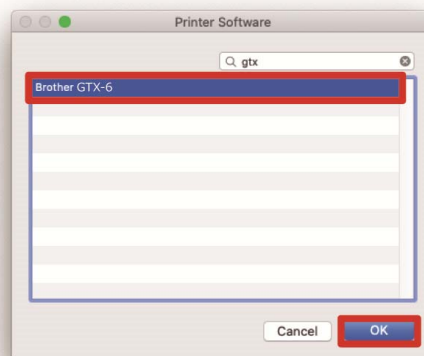

- Click [Add].

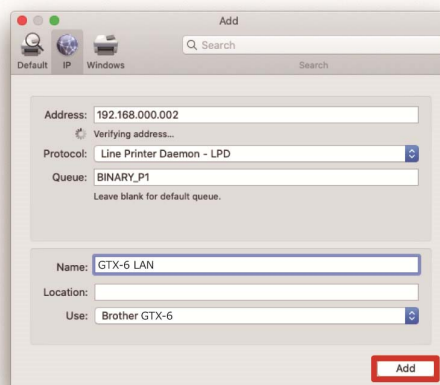

(8) The screen returns to the [Printers & Scanners] screen, and the GTX-6 printer (LAN) is added.

If necessary, select the GTX-6 printer under [Default Printer].

This exits the LAN settings.

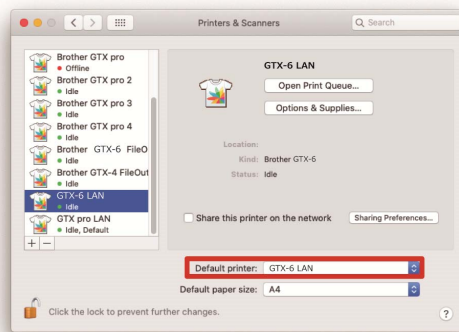



### 3-6. Adjustment

Adjust the printer using "GTX-6 Maintenance".

Menu name	Description	Things to prepare	See the operating procedure with GTX-6 Maintenance
[Initial settings after head replacement]	Make settings after print head replacement.	—	"3-6-1. Initial settings after head replacement >>P.3-24"
[Color adjustments between the two color heads]	Make adjustments after replacing the print head if the horizontal stripes (banding) in the picture are noticeable.	White paper	"3-6-2. Color adjustments between the two color heads >>P.3-25"
[Firing Adjustment]	Make adjustments after print head replacement if the print is blurred and the printed result appears too granular.	Black paper or transparent sheet (such as OHP sheet) White paper	"3-6-3. Firing adjustment >>P.3-26"
[2 same color heads position adjustment]	Make adjustments if misalignment occurs in white-only or color-only printing.	Black paper or transparent sheet (such as OHP sheet) White paper	"3-6-4. 2 same color heads position adjustment >>P.3-27"
[Platen-rolling adjustment]	Make adjustments if the horizontal stripes (banding) in the picture are noticeable after printing.	White paper	"3-6-5. Platen-rolling adjustment >>P.3-28"
[White/Color Alignment]	Make adjustments if the white and color images are out of position.	Black paper or pretreated black or dark color T-shirt	"3-6-6. White/color alignment >>P.3-29"
[Setting of the time displayed on the nozzle check pattern]	No settings are required if scheduled time settings for white ink circulation have been made.	—	"3-6-7. Setting of the time displayed on the nozzle check pattern >>P.3-30"
[Set the scheduled time for white ink circulation]	Make settings when making a time reservation for white ink circulation or canceling the reservation.	—	"3-6-8. Set the scheduled time for white ink circulation >>P.3-32"
[Humidification Schedule Settings]	Set the start time and end time for humidification.	—	"3-6-9. Humidification Schedule Settings >>P.3-35"

### 3-6-1. Initial settings after head replacement

Set V-rating after replacing the print head or completing the setup procedure.

- (1) Make sure that the printer and PC are connected via a LAN cable.
- (2) On the PC, from [All Programs] in the Start menu, select the "GTX-6 Maintenance" from "Brother GTX-6 Tools".
- (3) After the window shown below appears, select [Initial settings after head replacement] and click [Next].

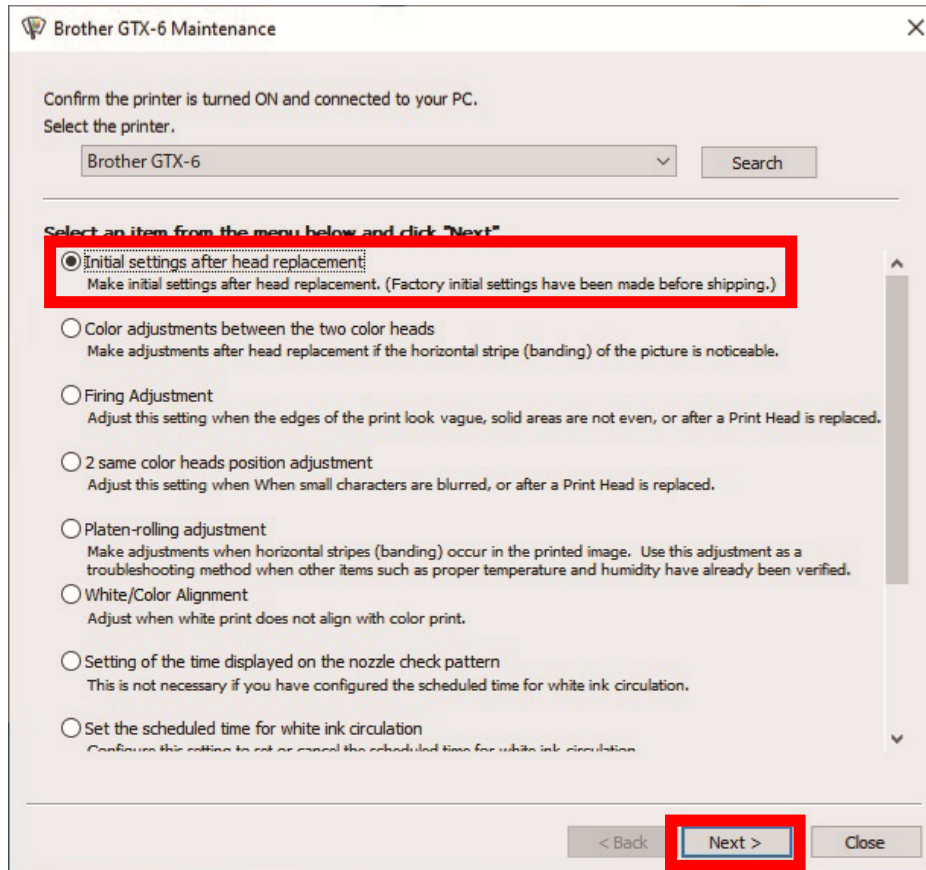

- (4) Perform the required operation by following the on-screen instructions in the dialog box. After the adjustment is completed, the currently displayed screen will go back to the window mentioned above.

### 3-6-2. Color adjustments between the two color heads

Make adjustments after replacing the print head or completing the setup procedure, or if horizontal stripes appear in the printing.

If you want to make adjustments after replacing the print head, configure the initial settings after print head replacement and adjust the firing timing before you do so.

- (1) Make several sheets of A4-size or letter-size white paper available for use.
- (2) Make sure that the printer and PC are connected via a LAN cable.
- (3) On the PC, select "GTX-6 Maintenance" under "Brother GTX-6 Tools" from [All Programs] in the Start menu.
- (4) When the window shown below is displayed, select [Color adjustments between the two color heads] and click [Next].

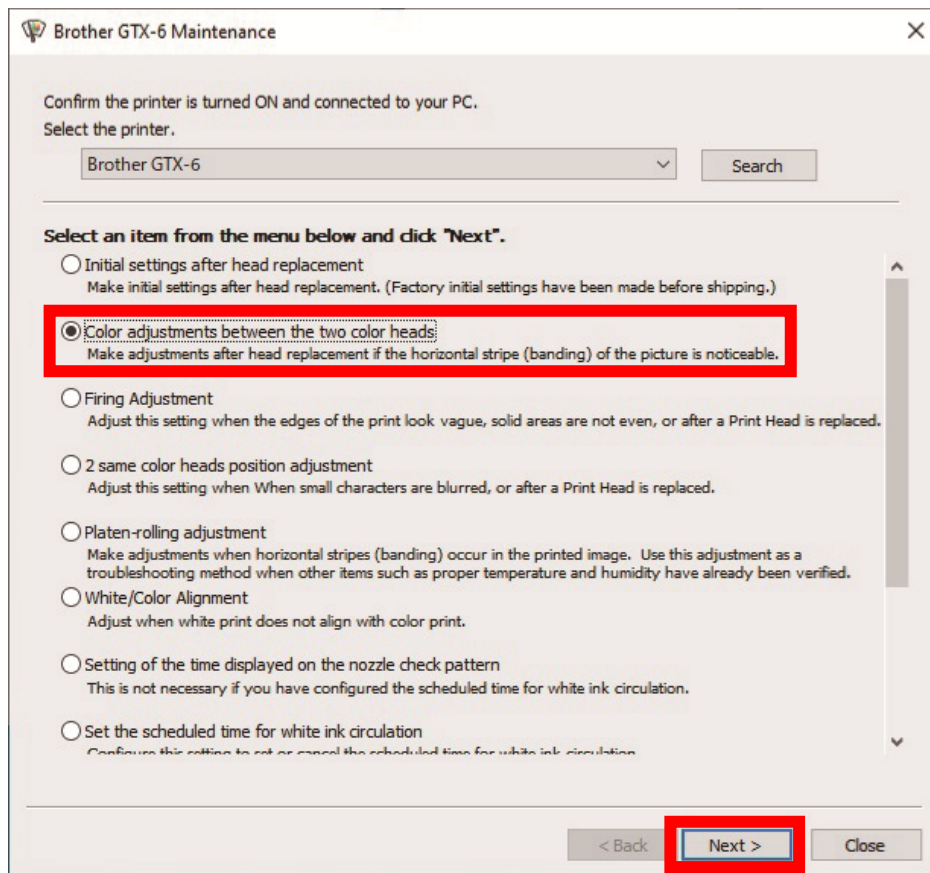

- (5) Follow the instructions in the dialog box that appears on the screen.  
After the adjustment is completed, the currently displayed screen will go back to the window mentioned above.

### 3-6-3. Firing adjustment

Because the ejection timing varies depending on the platen's height and properties of each print head, this function is provided to adjust the ejection timing for each print head when any print head is replaced with a new one or after the completion of the setup procedure, for instance. If you want to make adjustments after replacing the print head, configure the initial settings after print head replacement before you do so.

- (1) Make several sheets of A4-size or letter-size paper (black paper or transparent sheet such as OHP sheet, and white paper) available for use.
- (2) Make sure that the printer and PC are connected via a LAN cable.
- (3) On the PC, from [All Programs] in the Start menu, select the "GTX-6 Maintenance" from "Brother GTX-6 Tools".
- (4) After the window shown below appears, select [Firing Adjustment] and click [Next].

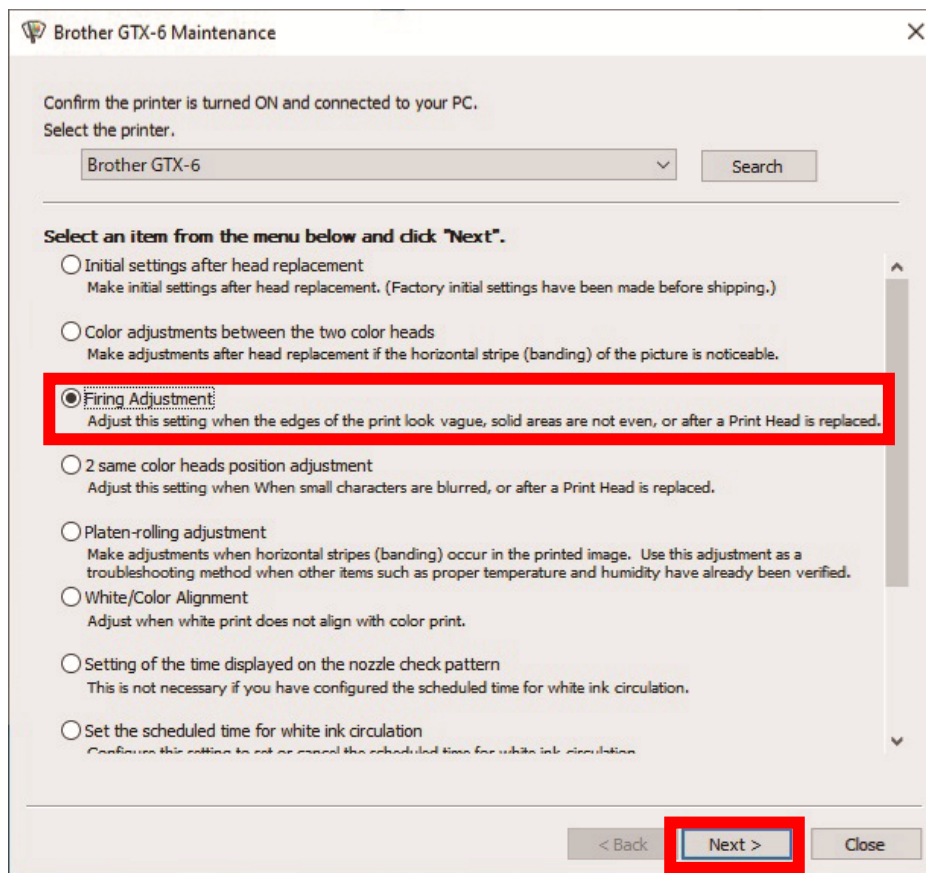

- (5) Perform the required operation by following the on-screen instructions in the dialog box. After the adjustment is completed, the currently displayed screen will go back to the window mentioned above.

### 3-6-4. 2 same color heads position adjustment

This is the adjustment function to align the print position on the white side with the print position on the color side. Make adjustments after replacing a print head or completing the setup procedure.

If you want to make adjustments after replacing the print head, configure the initial settings after print head replacement and adjust the firing timing before you do so.

- (1) Make several sheets of A4-size or letter-size paper (black paper sheets or transparent sheets, such as OHP sheets, along with white paper sheets) available for use.
- (2) Make sure that the printer and PC are connected via a LAN cable.
- (3) On the PC, select "GTX-6 Maintenance" under "Brother GTX-6 Tools" from [All Programs] in the Start menu.
- (4) When the window shown below is displayed, select [2 same color heads position adjustment] and click [Next].

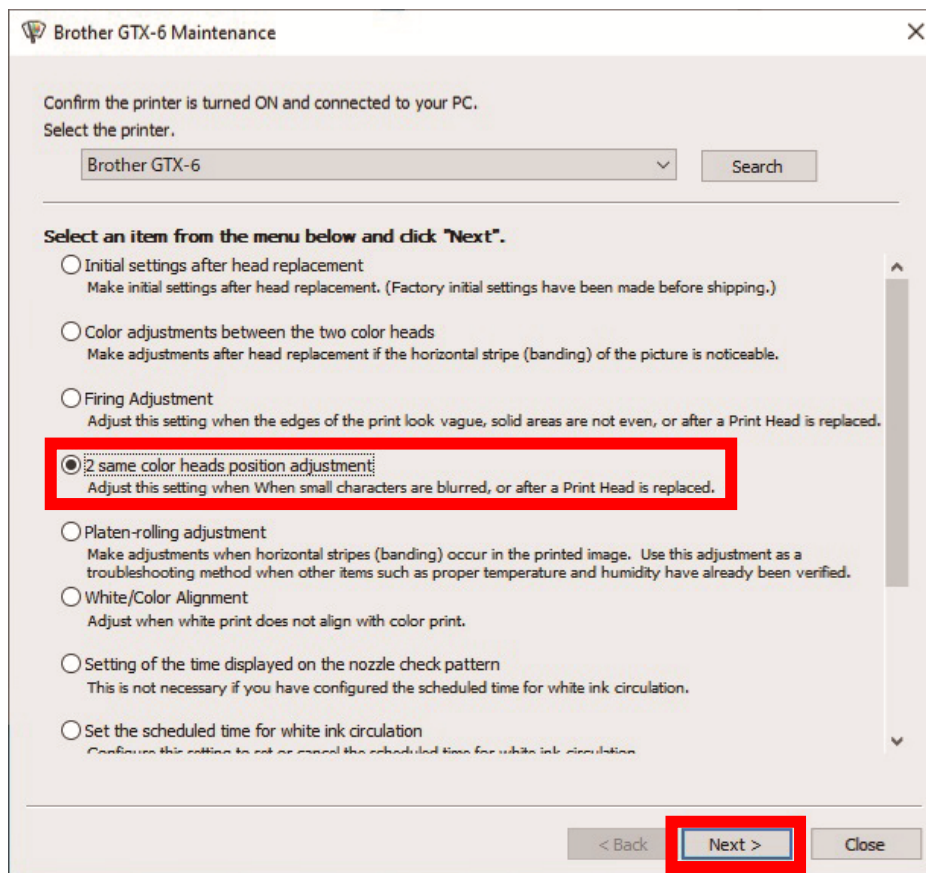

- (5) Follow the instructions in the dialog box that appears on the screen.  
After the adjustment is completed, the currently displayed screen will go back to the window mentioned above.



### 3-6-5. Platen-rolling adjustment

Make adjustments after replacing the print head or completing the setup procedure, or if horizontal streaks appear in the printing.

If you want to make adjustments after replacing the print head, configure the initial settings after print head replacement and adjust the firing timing before you do so.

- (1) Make several sheets of A4-size or letter-size white paper available for use.
- (2) Make sure that the printer and PC are connected via a LAN cable.
- (3) On the PC, select "GTX-6 Maintenance" under "Brother GTX-6 Tools" from [All Programs] in the Start menu.
- (4) When the window shown below is displayed, select [Platen-rolling adjustment] and click [Next].

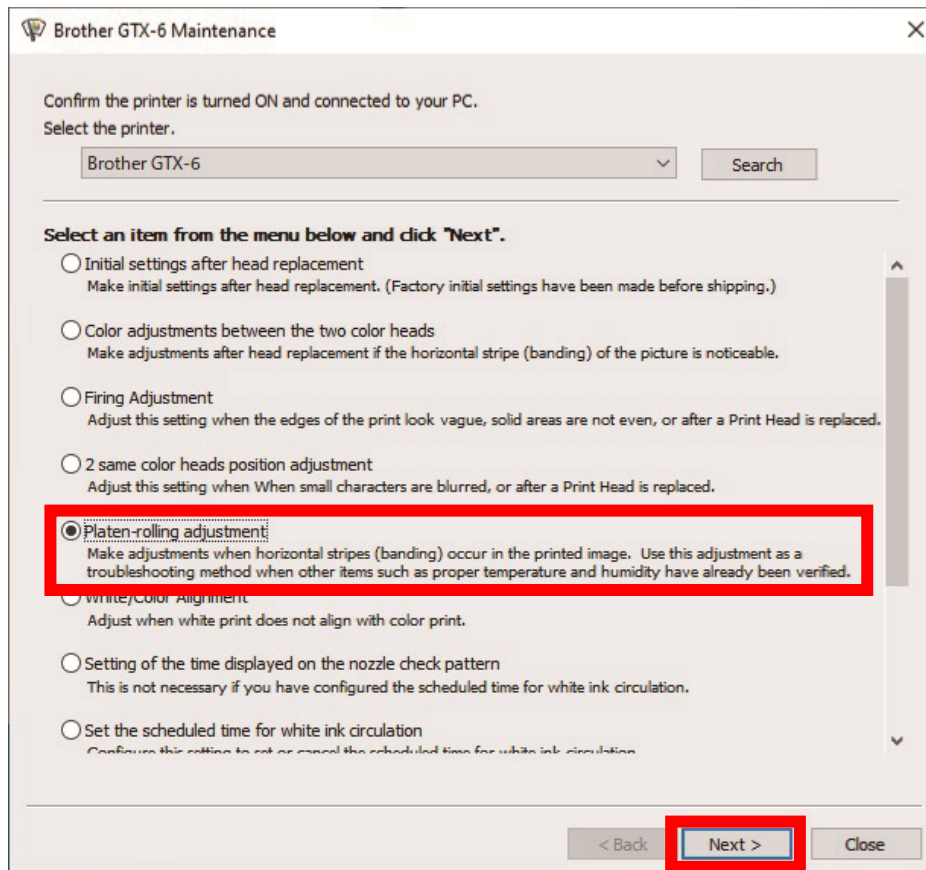

- (5) Follow the instructions in the dialog box that appears on the screen.  
After the adjustment is completed, the currently displayed screen will go back to the window mentioned above.

### 3-6-6. White/color alignment

This is the adjustment function to align the print position on the white side with the print position on the color side. Adjust white/color alignment after replacing a print head or completing the setup procedure.

If you want to make adjustments after replacing the print head, configure the initial settings after print head replacement and adjust the firing timing before you do so.

- (1) Prepare a sheet of black paper or a pretreated black or dark color T-shirt.
- (2) Make sure that the printer and PC are connected via a LAN cable.
- (3) On the PC, from [All Programs] in the Start menu, select the "GTX-6 Maintenance" from "Brother GTX-6 Tools".
- (4) After the window shown below appears, select the [White/Color Alignment] and click [Next].

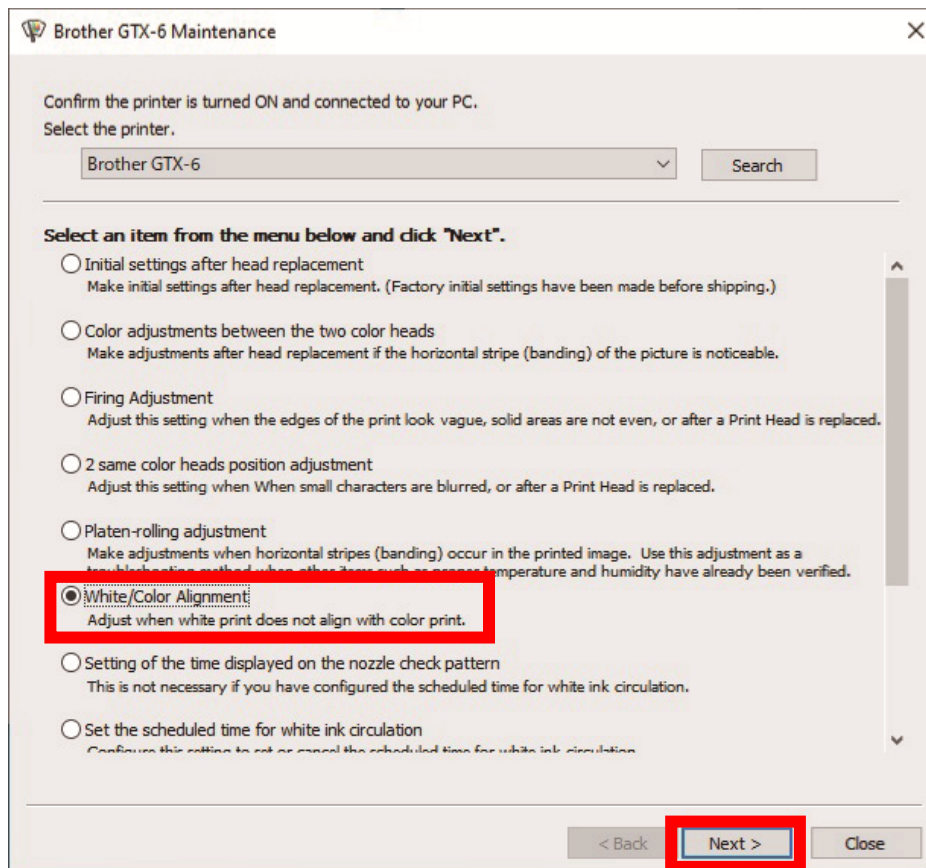

- (5) Perform the required operation by following the on-screen instructions in the dialog box.  
After the adjustment is completed, the currently displayed screen will go back to the window mentioned above.

### 3-6-7. Setting of the time displayed on the nozzle check pattern

Set the time displayed on the nozzle check pattern.

- (1) Make sure that the printer and PC are connected via a LAN cable.
- (2) On the PC, from [All Programs] in the Start menu, select the "GTX-6 Maintenance" from "Brother GTX-6 Tools".
- (3) After the window shown below appears, select [Setting of the time displayed on the nozzle check pattern] and click [Next].

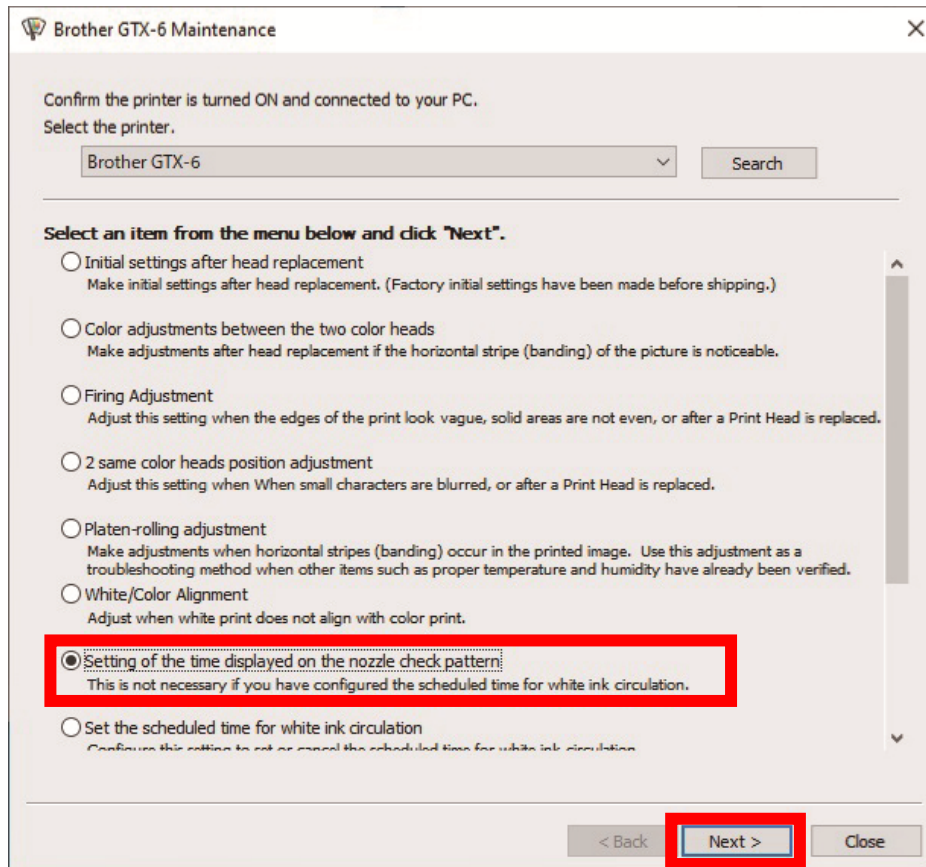



- (4) Perform the required operation by following the on-screen instructions in the dialog box.

<CAUTION>

- Confirm that the date and time of your PC are set correctly, and continue.

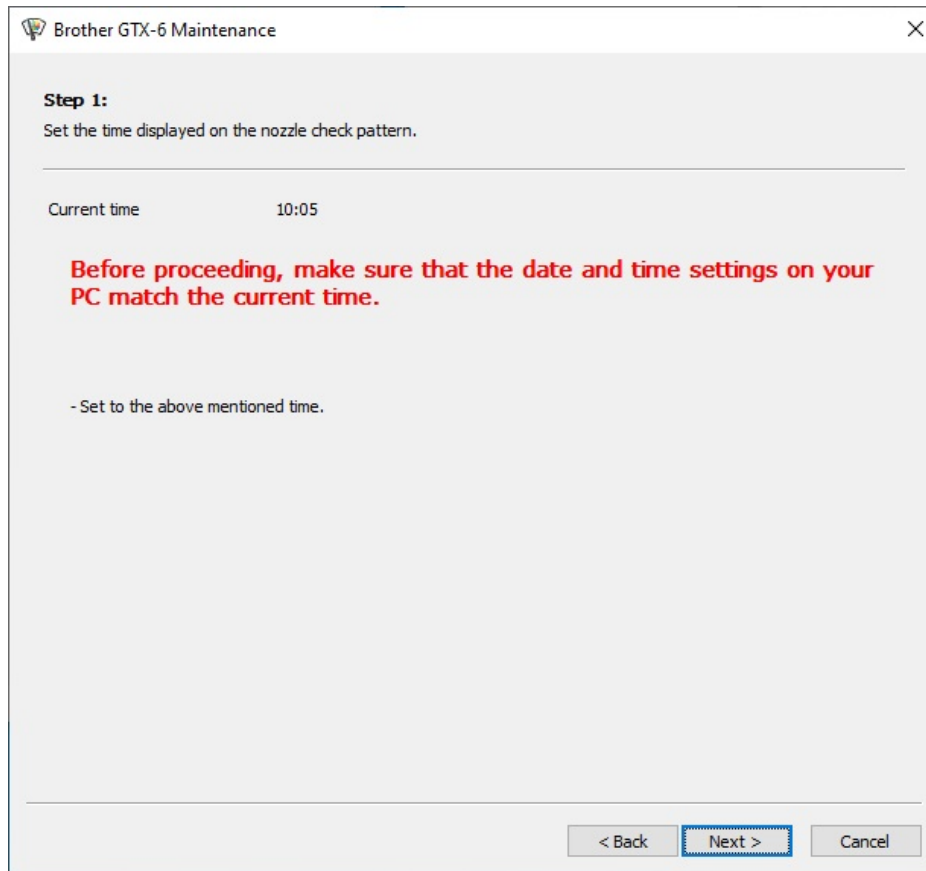

- (5) After the setting is completed, the currently displayed screen will go back to the Main screen.



### 3-6-8. Set the scheduled time for white ink circulation

White ink circulation can be performed at a specified time. If not set, white ink circulation will be performed automatically every four hours.

- (1) Make sure that the printer and PC are connected via a LAN cable.
- (2) On the PC, from [All Programs] in the Start menu, select the "GTX-6 Maintenance" from "Brother GTX-6 Tools".
- (3) After the window shown below appears, select [Set the scheduled time for white ink circulation] and click [Next].

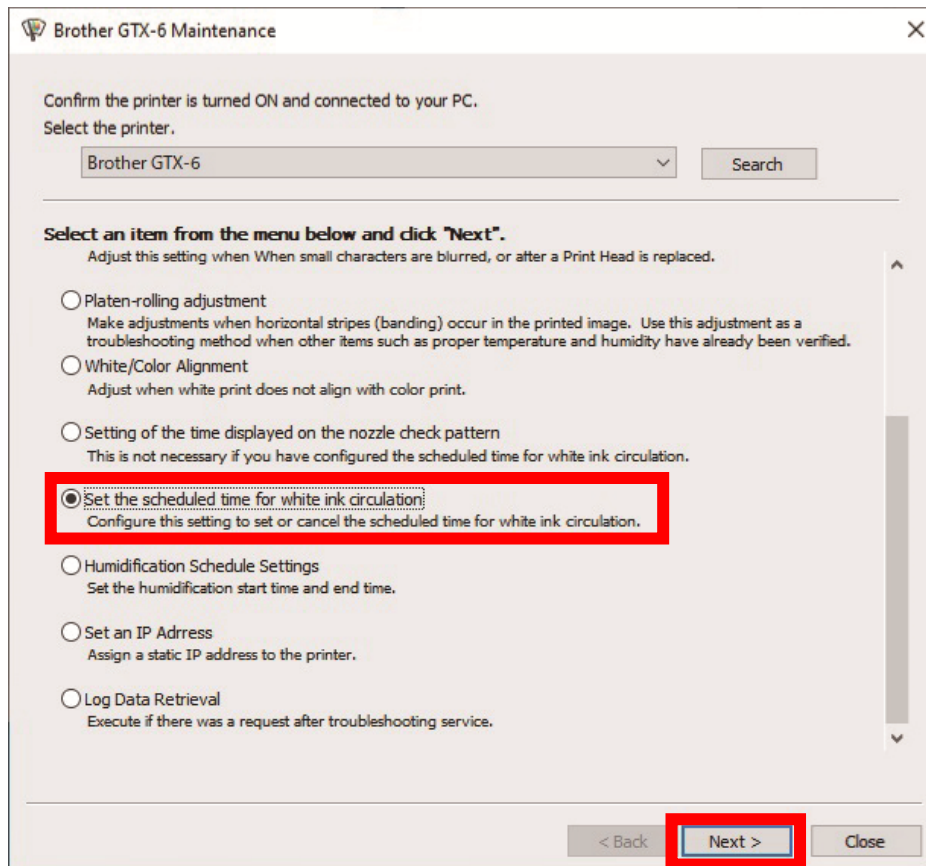

- (4) After the next window appears, select [Set the scheduled time for white ink circulation.]. Then, click [Next].

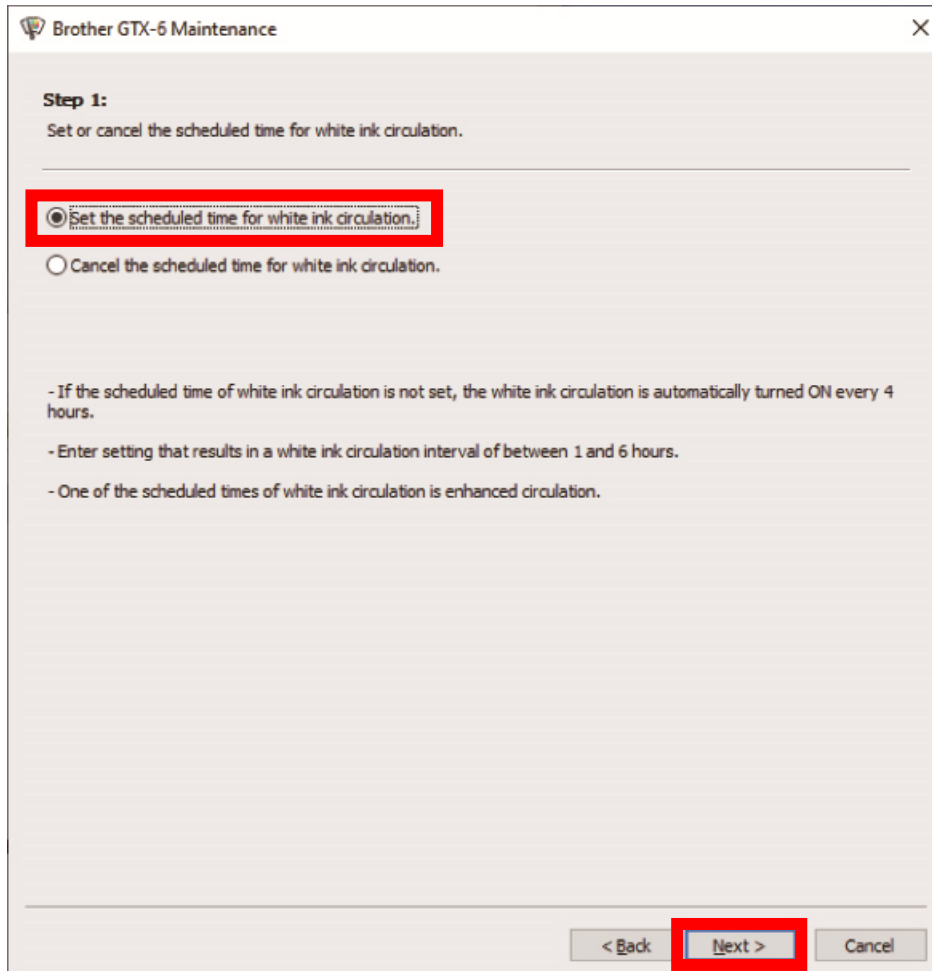

- (5) Set the scheduled time for white ink circulation and click [Next].

<CAUTION>

- Confirm that the date and time of your PC are set correctly, and continue.
- Enter at least six start-time settings.
- Set the white ink circulation interval to be between one hour and six hours.
- Input a time range of "0:00" to 23:59".

<TIPS>

- You can check on the main unit the scheduled time you set. ☞"7-23. Check circulation schedule >>P.7-18".

Brother GTX-6 Maintenance

**Step 2:**  
Set the scheduled time for white ink circulation.

Current time 13:37

Start time for white ink circulation

[1]   [2]   [3]   [4]

[5]   [6]   [7]   [8]

**Before proceeding, make sure that the date and time settings on your PC match the current time.**

- Enter the start time for white ink circulation.
- Input a time range of "0:00" to "23:59".  
For example, when setting the time "8:00," either "800" or "8:00" can be input.
- Enter at least 6 start times.
- Enter setting that results in a white ink circulation interval of between 1 and 6 hours.
- Select the time to start the enhanced white ink circulation with the corresponding radio button.

< Back **Next >** Cancel

### 3-6-9. Humidification Schedule Settings

Make settings when reserving the operation schedule of the humidifier.

- (1) Make sure that the printer and PC are connected via a LAN cable.
- (2) On the PC, from [All Programs] in the Start menu, select the "GTX-6 Maintenance" from "Brother GTX-6 Tools".
- (3) After the window shown below appears, select [Humidification Schedule Settings] and click [Next].

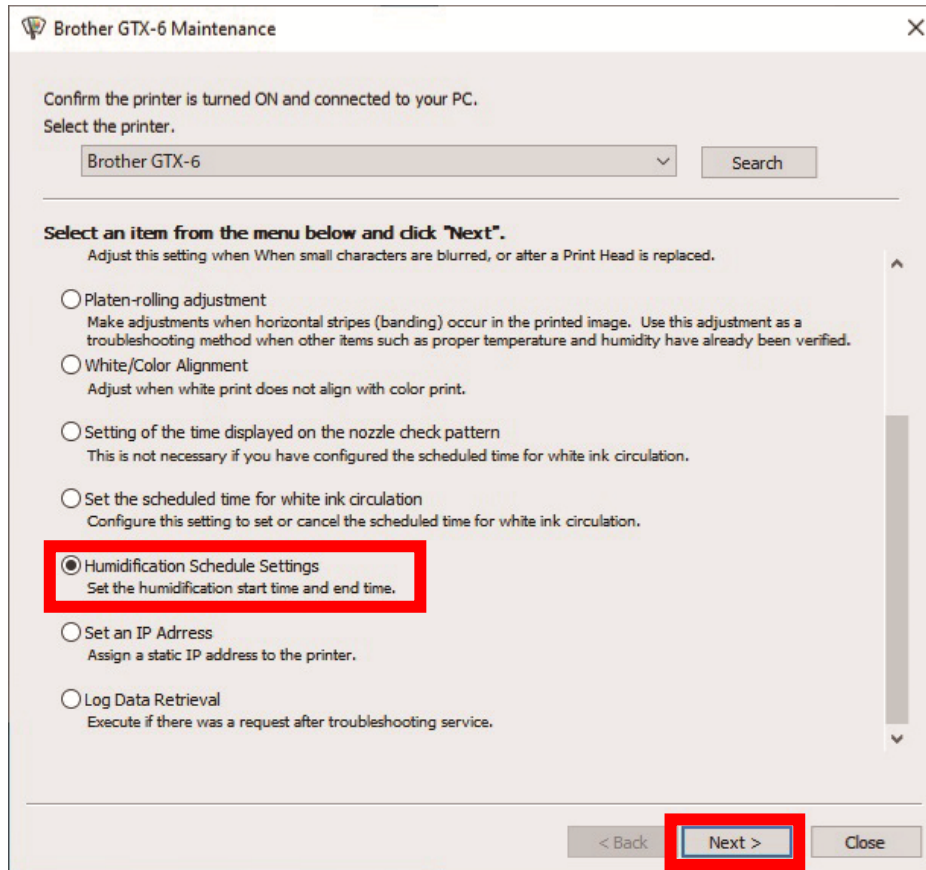

- (4) After the window shown below appears, click the [Set the scheduled time for humidification]. Then, click [Next].

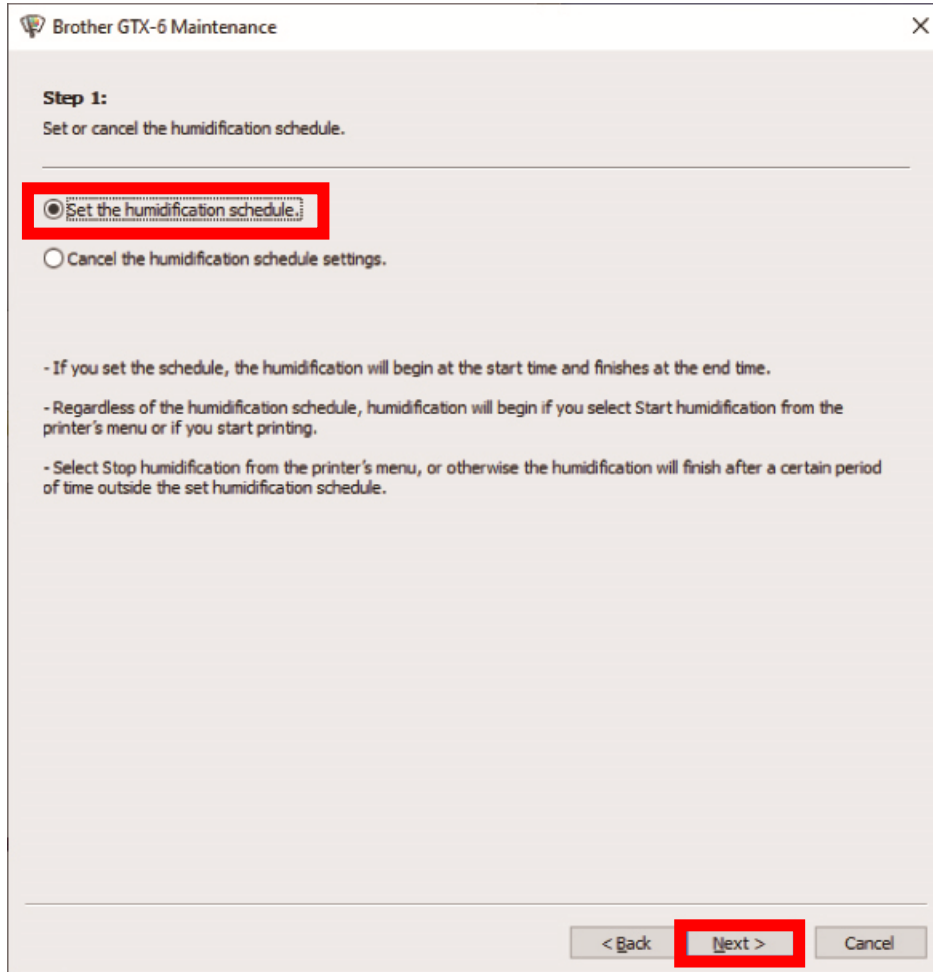

- (5) Set the start time and end time for humidification and click [Next].

<CAUTION>

- Confirm that the date and time of your PC are set correctly, and continue.
- You can enter the start time and end time if you check the day of the week. Humidification will not start or end in time on days that are not checked.
- Humidification will start at the start time. Specify one hour before printing. Insufficient humidification can affect print quality. Waste liquid increases to prevent the printer from malfunctioning.

<TIPS>

- You can check on the main unit the scheduled time you set.

Brother GTX-6 Maintenance

**Step 2:**  
Enter the start time and end time of humidification.

Current time 13:39

Day of the	Start time	End time
<input type="checkbox"/> Sun.		
<input checked="" type="checkbox"/> Mon.	09:00	17:59
<input type="checkbox"/> Tue.		
<input checked="" type="checkbox"/> Wed.	09:00	17:59
<input type="checkbox"/> Thu.		
<input type="checkbox"/> Fri.		
<input type="checkbox"/> Sat.		

- When you check a day of the week, you can enter the start time and end time. If the day of the week is unchecked, humidification will not start automatically.

- Humidification will start when the humidification time comes. Set about one hour before printing for the time. Insufficient humidification may affect the print quality and speed.

- The humidification will stop at the end time.

**Before proceeding, make sure that the date and time settings on your PC match the current time.**

< Back **Next >** Cancel

(6) Select the elapsed time to finish humidification and click [Next].

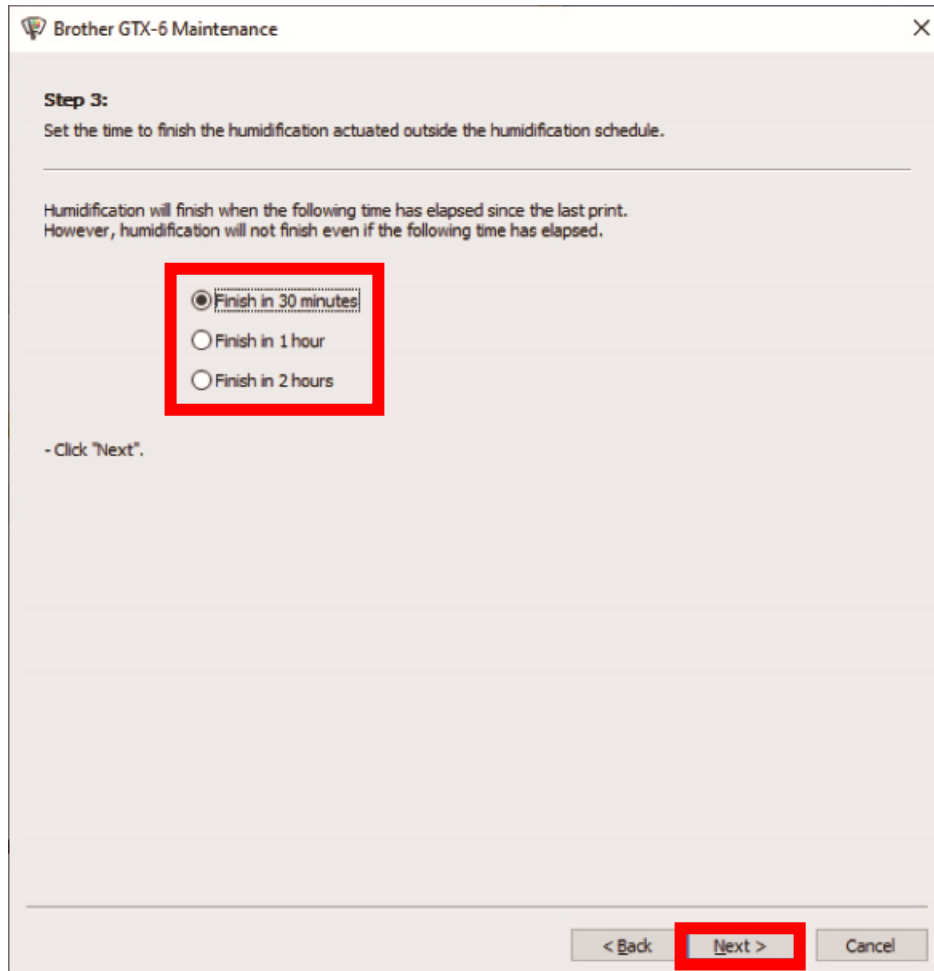



### 3-7. Moving the printer

When moving the printer elsewhere, please contact your dealer.

## 4-1. Types of applications

You can create print data by either "using Brother products" or "using other applications". Select applications to use depending on your needs.

You are recommended to use Brother product applications as far as possible. If you want to use other applications, however, you are recommended to use one of the three recommended applications to achieve high-quality print results. This chapter describes the procedures for using other applications.

### Using Brother products

Applications to use	Reference
GTX Graphics Lab	Graphics Lab Instruction Manual

### When using other applications

Applications to use	Reference
CorelDRAW (2020/2021)	"4-3-1. When using CorelDRAW >>P.4-4"
Adobe Photoshop CC	"4-3-2. When using Adobe Photoshop >>P.4-11"
Adobe Illustrator CC	"4-3-3. When using Adobe Illustrator >>P.4-16"

#### <TIPS>

- Make proper settings, such as color settings and printing conditions, of each application, in accordance with the setting contents of the application.
- In this chapter, the value RGB=(254,254,254) is described as "RGB=254", and the value RGB=(255,255,255) is described as "RGB=255".

## About color mode (color space)

The GTX-6 printer is a printer of RGB type.

Be sure to create image data in RGB mode, and always set the color space (input) you use for such data to sRGB (sRGB IEC61966-2.1).

### <TIPS>

- When such application as Adobe and Corel is used, there are instances in which an image in CMYK mode cannot reproduce the color that is intended.
- Even for an image in RGB mode, a similar color reproduction failure occurs when other color space than the specified one, such as Adobe RGB, is used.

## About print layout

Specify the platen size that uses the paper size specified in the Print menu, and confirm the print layout.

Moreover, use the "Brother GTX-6 FileOutput" printer driver for file output, then display and check the print preview.

### <TIPS>

- For a print image to be oriented properly at all times, it is advisable to set the GTX-6 printer to the [Set as default printer] for the PC.

## How to create white data

When creating print data with [Color + White Ink] or [White Ink Only], RGB=255 is treated as "Transparent color", ejecting no ink.

For an image that you want to print pure white color with white ink, make sure that the white areas are set to RGB=254.

### <TIPS>

- The treatment of RGB=255 varies depending on the applications.  
Configure the settings appropriately.

## About ARX6 file

Use the "Brother GTX-6 FileOutput" printer driver for file output in order to save your print data in the ARX6 format.

When your print data is saved in the ARX6 format, its information and the amount of used ink will be able to be reviewed.

### <TIPS>

- When performing file output, be sure to use the printer driver, "Brother GTX-6 FileOutput". If file output is performed using [Print to file] command that is supplied with each application, there may be some cases where the file extension cannot be saved as .arx6, or the file destination cannot be specified.
- ARX4 files created with the GTX-4 and ARXP files created with the GTX pro can be printed with the GTX-6.
- The GTX-6 printer cannot print out the print data that has been created for the GT-541/GT-782/ GT-3 series.
- If you make a printer driver setting from the Control Panel of your PC, such setting sometimes will not take effect in each application. For this reason, verify that your printer driver has been set up properly before you begin printing.

## 4-2. Sending print data using Brother GTX-6 FileOutput (for Macintosh only)

### Saving print data to a file

Check that the "GTX-6 File Viewer" is running when saving print data to a file using the "Brother GTX-6 FileOutput" printer.

The error shown below will occur, and you will not be able to save the data if you output without "GTX-6 FileViewer" running.

<TIPS>

- Depending on the application, the following error may or may not appear. Try again with the "GTX-6 FileViewer" running.



<TIPS>

- The procedure for outputting a file from "Brother GTX-6 FileOutput" is the same as that for a Windows PC.

### Sending print data

Follow the procedure below to send print data to the printer if the print data has been saved using the "Brother GTX-6 FileOutput" printer.

<TIPS>

- The procedure for sending print data is the same as that for a Windows PC.

- (1) Double-click the file with the extension .arx6 saved using the "Brother GTX-6 FileOutput" printer.
- (2) "GTX-6 FileViewer" will be launched, and the file will be sent when you click [Send to Printer].

## 4-3. Using other applications

### 4-3-1. When using CoreIDRAW

First of all, perform the following procedures:

- Color setting
- Print size

As required, perform the following procedures:

- Create print data (ARX6 file).
- Use the color palette in Useful Tools.
- Convert data to bitmap image data.
- Replace RGB=255 in bitmap image data with RGB=254.

#### <TIPS>

- For this printer, it is recommendable to use CoreIDRAW 2020/2021. The display screen is described assuming CoreIDRAW 2019.

### Color management settings

- (1) In the menu bar, select [Tools] > [Color Management].
- (2) Establish the settings in [Color management settings] as follows:
  - [RGB Profile]: [sRGB IEC61966-2.1]
  - [Primary color mode]: [RGB]
  - [Rendering intent]: [Relative colorimetric]

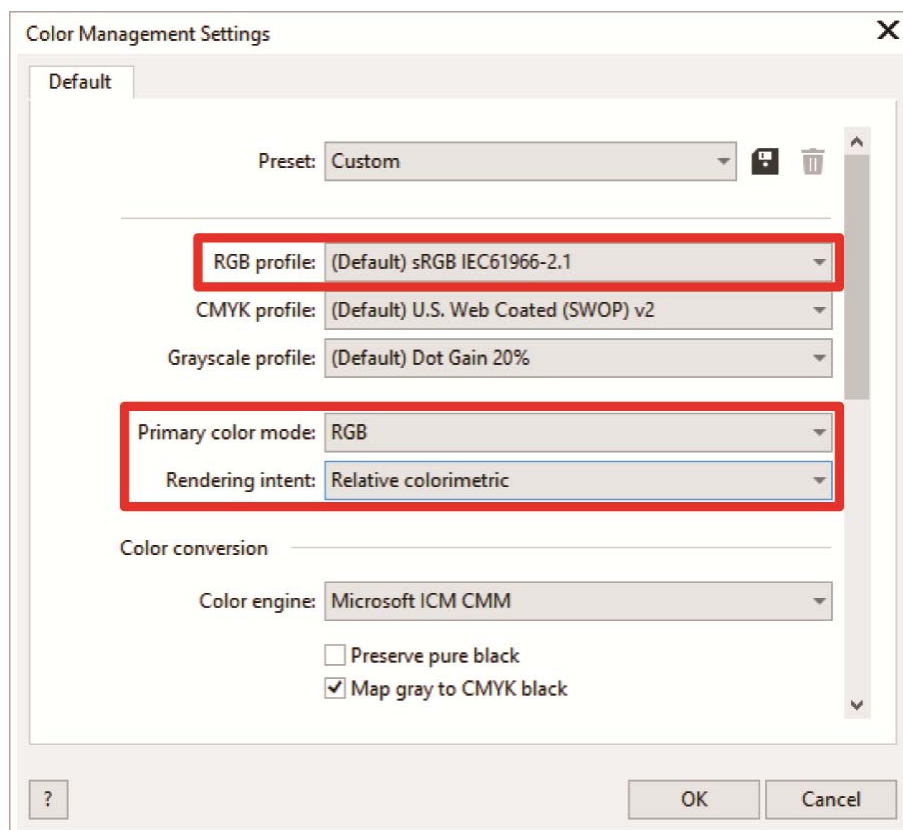

## Print size

- (1) In the menu bar, select [File] > [Print].
- (2) Set the [Printer] to either "Brother GTX-6" or "Brother GTX-6 FileOutput", click on [Apply], and close the [Print] dialog box.

### <TIPS>

- If [Printer] is set to "Brother GTX-6", the print data at the time of printing will be sent to the printer.  
If [Printer] is set to "Brother GTX-6 FileOutput", the print data at the time of printing will be saved as an ARX6 file.

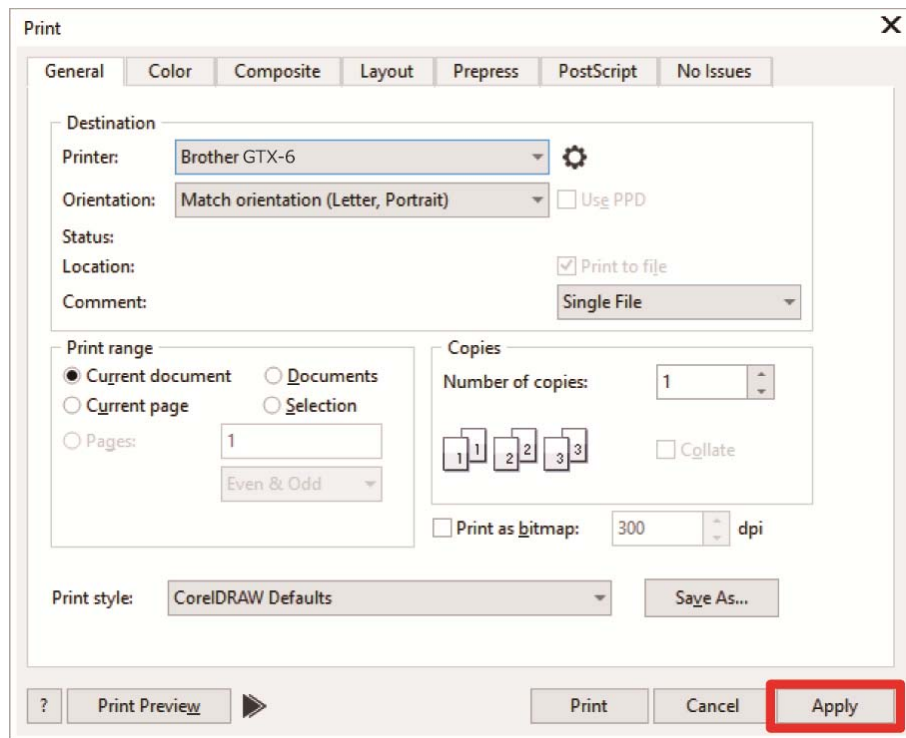



- (3) In the menu bar, select [Layout] > [Page Layout].

**(4)** Make the following settings in the [Page Size] window:

- [Size]: [Custom]
- [Width]: 14.6 in. (370 mm)
- [Height]: 16.5 in. (420 mm)
- Page orientation: Portrait

## &lt;TIPS&gt;

- Set the width and height to the size of platen to be used. The above size is the standard 14X16 platen size.
  - In the case of print data using white ink  "4-4-2. Select the platen size >>P.4-24"
  - In the case of print data using color ink and black ink only  "4-5-2. Select the platen size >>P.4-41"

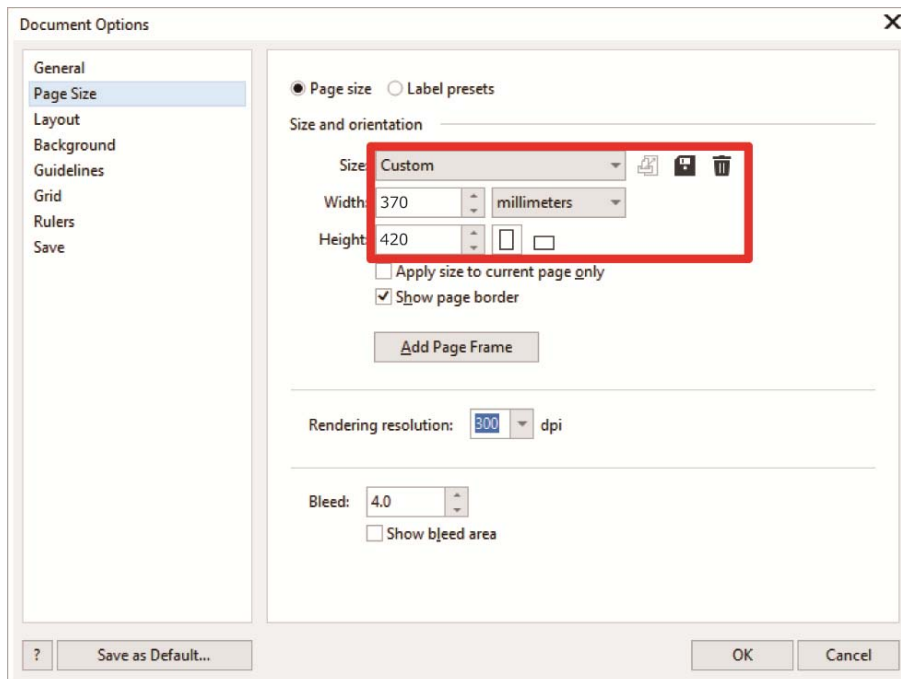

## Create print data (ARX6 file)

Save the image data and print settings as a set of print data in ARX6 file format.

The following will be made available if the print data is converted into an ARX6 file:

- Image data and print settings can be put together and stored.
- Without connection to a PC, the printing can be performed directly from a USB flash memory.

### <TIPS>

- Image editing is unavailable for any ARX6 file. As such, save your image data for an editing purpose in advance.
- For file output, there are some cases where neither file output destination nor extension cannot be specified by the [Print to file] command. Be sure to use the printer driver "Brother GTX-6 FileOutput".
- For details of directly sending data to the printer from an application, see "5-6-2. Sending print data from applications >>P.5-24"

(1) In the menu bar, select [File] > [Print].

(2) Open the [Color] tab, and make the following settings:

- Place a checkmark in the [Document color] checkbox.
- [Color conversions]: "Brother GTX-6" or "Brother GTX-6 FileOutput"
- [Color Profile]: [sRGB IEC61966-2.1]
- [Rendering intent]: [Relative colorimetric]

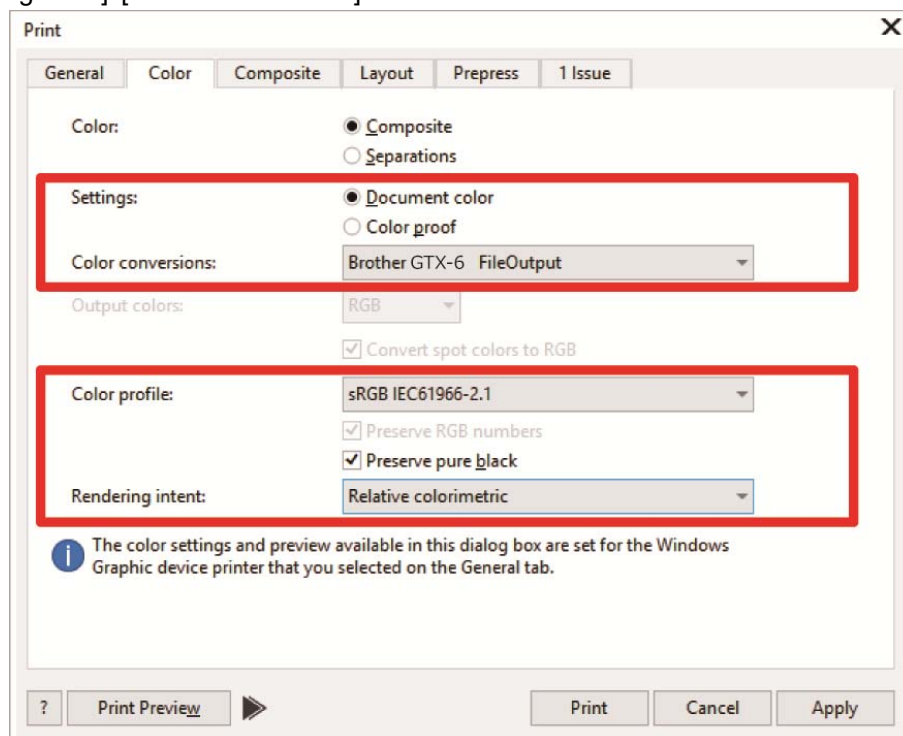

(3) On [General] tab, select [Printer] and select "Brother GTX-6 FileOutput" for file output.

### <TIPS>

- If the specified [Printer] is set to "Brother GTX-6", the print data will be sent to the printer.  
If the specified [Printer] is set to "Brother GTX-6 FileOutput", the print data will be saved as an ARX6 file.

(4) On [Preferences], create your settings of printer driver.

- In the case of print data using white ink see "4-4-1. Setting up the printer driver >>P.4-22"
- In the case of print data using color ink and black ink only see "4-5-1. Setting up the printer driver >>P.4-39"



- (5) When you press [OK] in the [Print] dialog box, the dialog box shown below will be displayed. After that, click [Save].

<TIPS>

- There may be cases where this saving process takes several minutes.

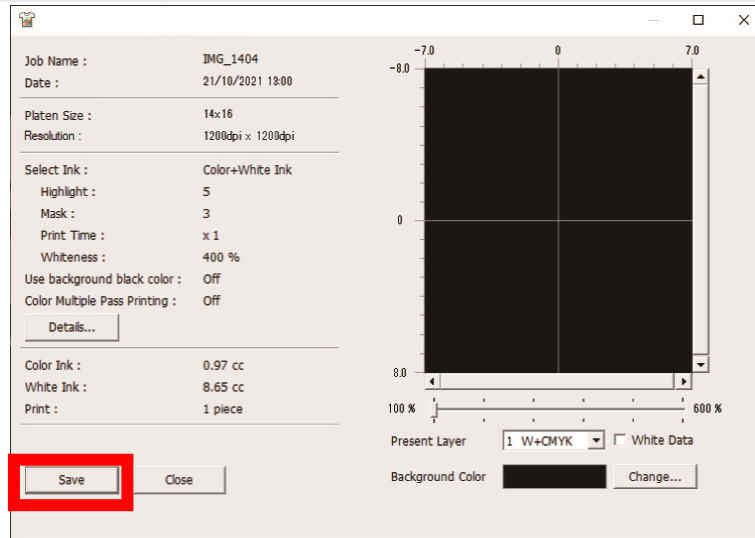

- (6) Specify the [Save In] and [File name] first, and then click [Save] to save the ARX6 file to your PC.

### Use the color palette in Useful Tools.

- (1) Save the color pallet files for CorelDRAW, "GT\_Colors.xml" and "GT\_Tshirts.xml", on your PC, following the instructions on screen.
- (2) In the menu bar, select [Window] > [Color Palettes] > [Open Palette].
- (3) Select the files having such filename as "GT\_Colors.xml" and "GT\_Tshirts.xml", respectively.

<TIPS>

- Do not use any color from the color sample palette, such as HKS and Pantone. Otherwise, an on-screen color may differ from the resulting print color.

## Convert data to bitmap image data

- (1) In the menu bar, select [Bitmaps] > [Convert To Bitmap].
- (2) Set the [Color mode] to [RGB Color].

### <TIPS>

- When the white ink is used for performing the printing, unmark the [Anti-aliasing] checkbox.

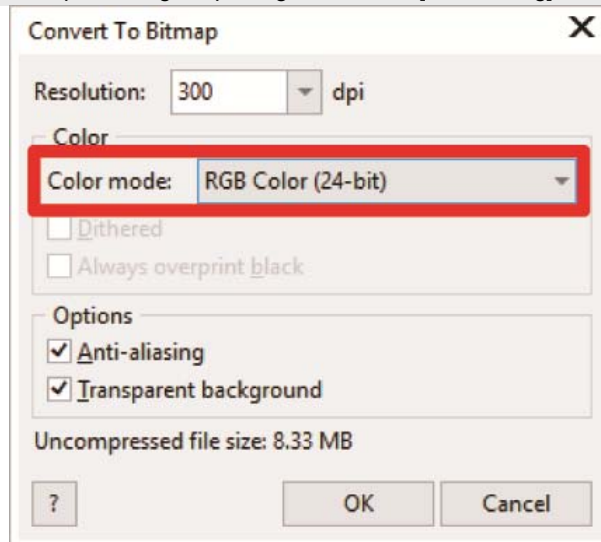

### <TIPS>

- Even when the platen size to be used has been selected from the printer driver, the current setting in [Page Layout] may change to [Settings from printer].  
In the [Page Layout], be sure to change the width and the height according to the size of the platen.

## Replace RGB=255 in bitmap image data with RGB=254

RGB=255 is identified as a transparent color. To a portion where RGB=255 is contained, no ink will be ejected. In order for the white ink to be printed, select an area for RGB=255, and replace it with RGB=254. To make such replacement, use the method mentioned below.

- (1) In the menu bar, select [Effects] > [Adjust] > [Replace Colors].
- (2) From the [Original] pull-down menu, set RGB=255 in [Replace Colors].

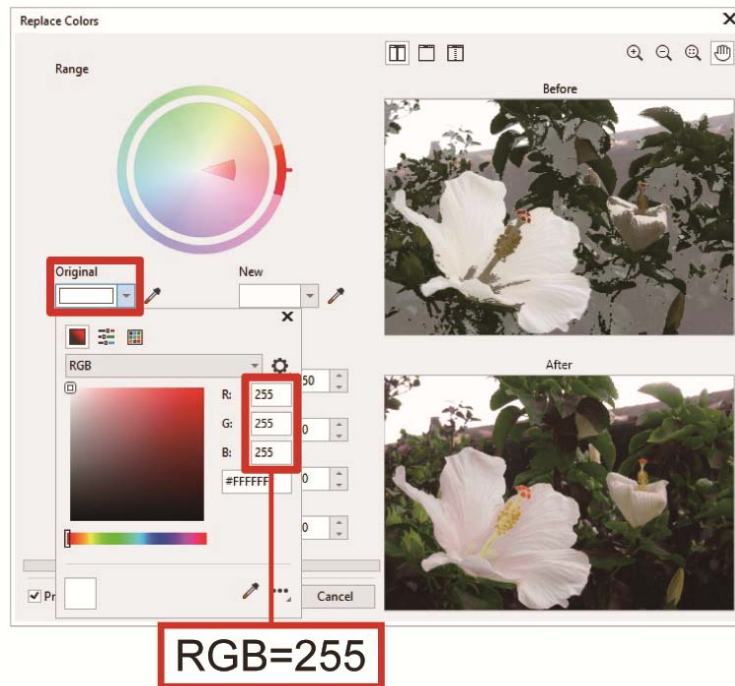

- (3) In the same manner, set [New color] to RGB=254.
- (4) Check the [Single Color] check box, and click on the [OK] button.

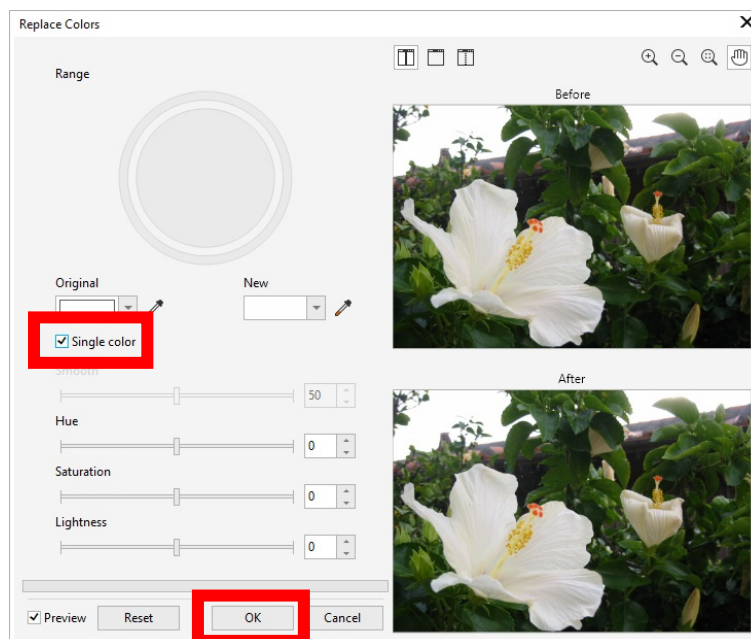

### <TIPS>

- For the vector data, change the fill color to RGB=254.

## 4-3-2. When using Adobe Photoshop

In Photoshop, configure the settings mentioned below:

- Color setting

As required, perform the following procedures:

- Create print data (ARX6 file)
- Use the color palette in Useful Tools.
- Replace RGB=255 with RGB=254

### <TIPS>

- For an image created in the CMYK color mode, select [Image] > [Mode] in the menu bar, and change the color to the RGB color (sRGB). In order to edit an image, select [Image] > [Adjustments] in the menu bar and edit it, or edit it by means of the image quality improvement of the printer driver.
  - In the case of print data using white ink "4-4-10. Set up the image quality >>P.4-36"
  - In the case of print data using color ink and black ink only "4-5-6. Set up the image quality >>P.4-46"
- For this printer, it is recommended to use Photoshop CC. The display screen is described in Photoshop CC.

## Color setting

(1) In the menu bar, select [Edit] > [Color Settings].

(2) Establish the settings of [Color Settings] as follows:

[Working Spaces]

- [RGB]: [sRGB IEC61966-2.1]

[Conversion Options]

- [Engine]: [Adobe(ACE)]
- [Intent]: [Relative Colorimetric]

[Color Management Policies]

- [RGB]: [Convert to Working RGB]
- [CMYK]: [Convert to Working CMYK]
- [Gray]: [Convert to Working Gray]
- [Profile Mismatches]: Mark the [Ask When Opening] and [Ask When Pasting] checkboxes.
- [Missing profiles]: Mark the [Ask When Opening] checkbox.

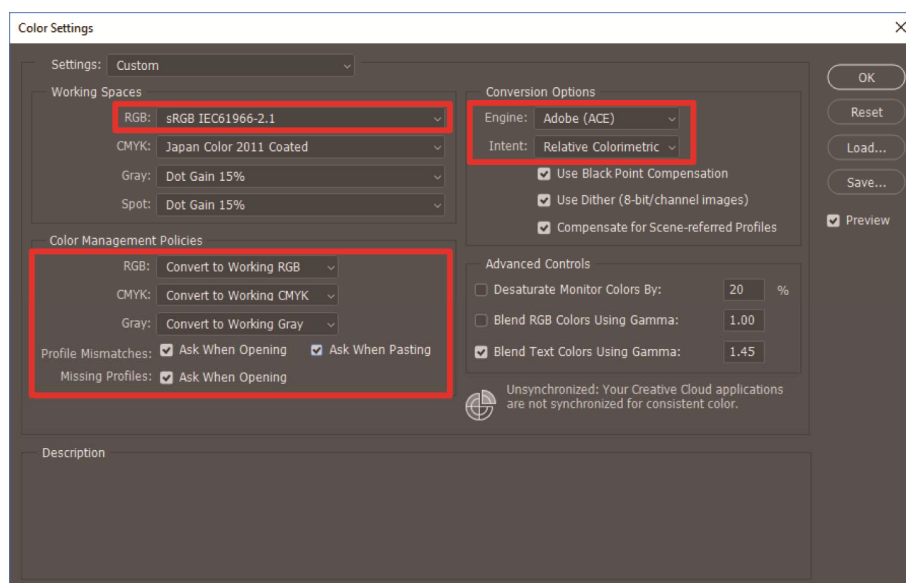

## Create print data (ARX6 file)

Save the image data and print settings as a set of print data in ARX6 file format.

The following will be made available if the print data is converted into an ARX6 file:

- Image data and print settings can be put together and stored.
- Without connection to a PC, the printing can be performed directly from a USB flash memory.

### <TIPS>

- Image editing is unavailable for any ARX6 file. As such, save your image data for an editing purpose in advance.
- For file output, there are some cases where neither file output destination nor extension cannot be specified by the [Print to file] command. Be sure to use the printer driver "Brother GTX-6 FileOutput".
- For details of directly sending data to the printer from an application, see "5-6-2. Sending print data from applications >>P.5-24"

(1) In the menu bar, select [File] > [Print]. If the PC's default printer is either "Brother GTX-6" or "Brother GTX-6 FileOutput", the layout is set to the platen size.

(2) Make the settings as follows:

- [Color Handling]: [Printer Manages Colors]
- [Rendering Intent]: [Relative Colorimetric]

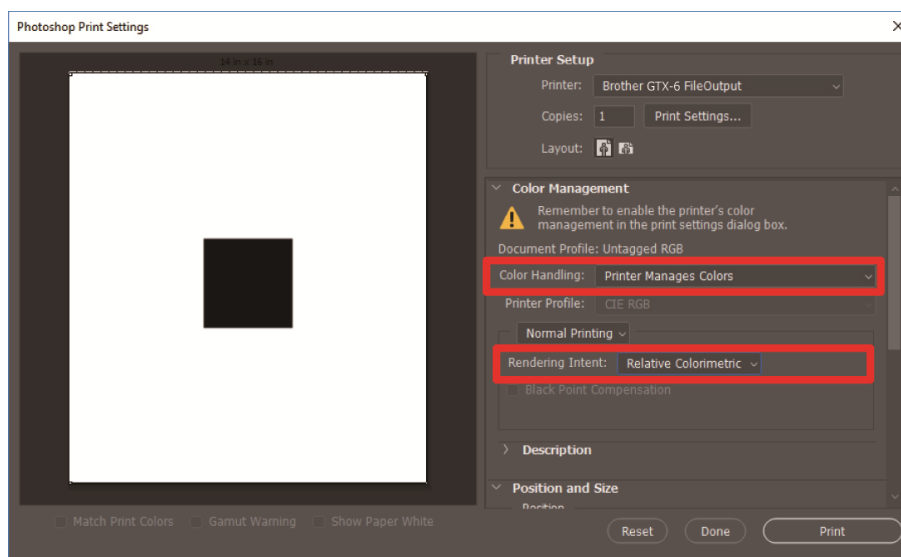

(3) From [Printer], select "Brother GTX-6 FileOutput" for file output.

### <TIPS>

- If [Printer] is set to "Brother GTX-6", the print data will be sent to the printer.  
If [Printer] is set to "Brother GTX-6 FileOutput", the print data will be saved as an ARX6 file.

(4) On [Print Settings], make your settings for the printer driver.

- In the case of print data using white ink see "4-4-1. Setting up the printer driver >>P.4-22"
- In the case of print data using color ink and black ink only see "4-5-1. Setting up the printer driver >>P.4-39"

- (5) When you press [Print], the dialog box shown below will be displayed on the screen. After that, click [Save].

<TIPS>

- There may be cases where this saving process takes several minutes.

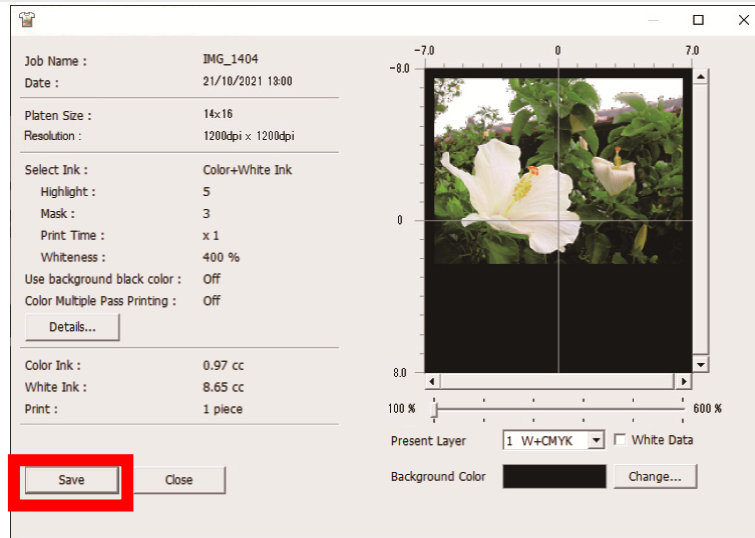

- (6) Specify the [Save In] and [File name] first, and then click [Save] to save the ARX6 file to your PC.

### Use the color palette in Useful Tools.

- (1) Save the color pallet file for Photoshop, "GT\_Colors\_T.ase", on your PC, following the instructions on screen.
- (2) In the menu bar, select [Window] > [Swatches].
- (3) Click on  to open the submenu.

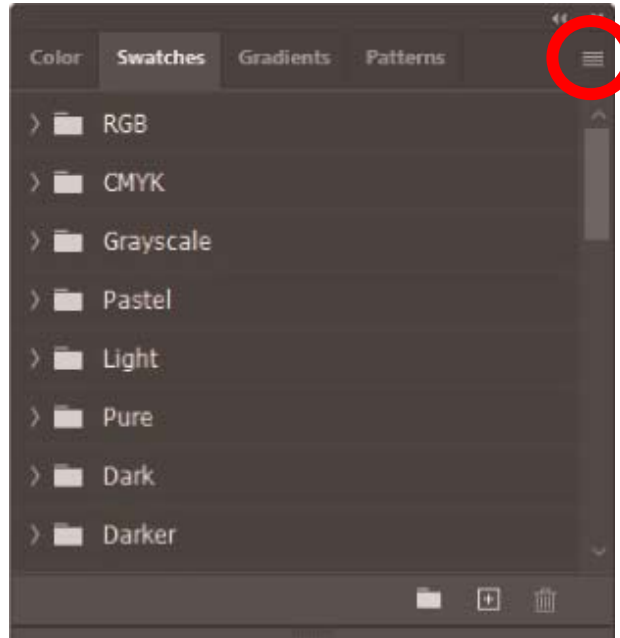

- (4) From [Read Swatches], select [Swatch Exchange (\*.ASE)] for the type of file and then select the file name [GT\_Colors\_T.ase].

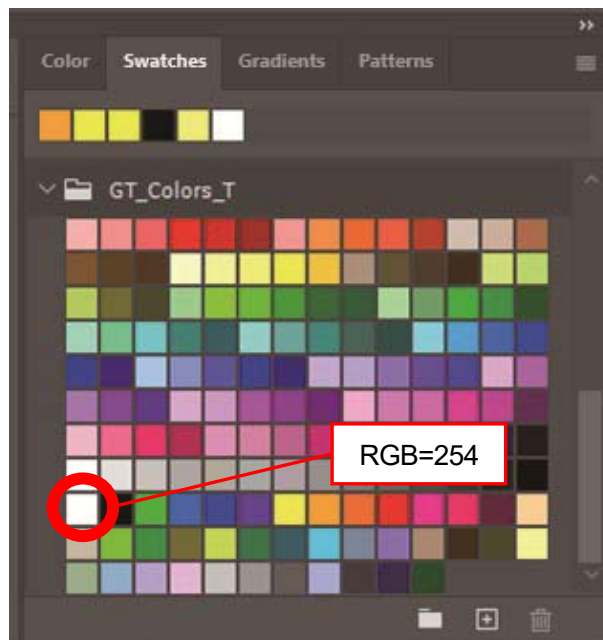

#### <TIPS>

- Do not use any color from the color sample palette, such as HKS and Pantone. Otherwise, an on-screen color may differ from the resulting print color.

## What to do when replacing RGB=255 with RGB=254

RGB=255 is identified as a transparent color. To a portion where RGB=255 is contained, no ink will be ejected. In order for the white ink to be printed, select an area for RGB=255, and replace it with RGB=254. To make such replacement, use the method mentioned below.

- (1) On the menu bar, select [Layer] > [New Adjustment Layer] > [Selective Color], and create a new layer.
- (2) Set the opacity to 20%, and click [OK].

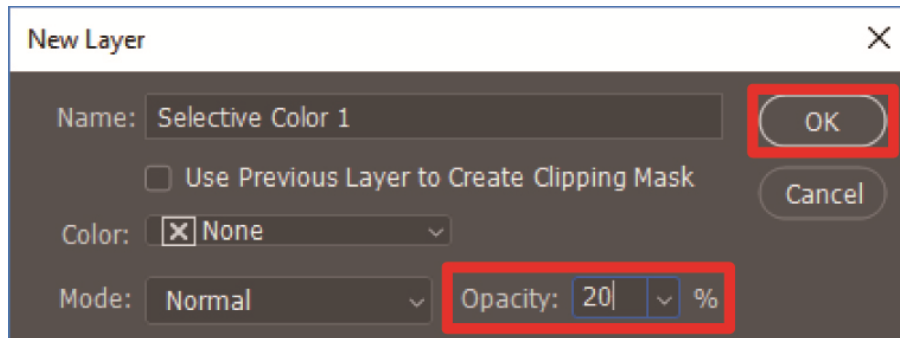

- (3) From the [Selective Color], make the following settings:
  - [Colors]: [Whites]
  - [Black]: 1%
  - Mark the [Absolute] option

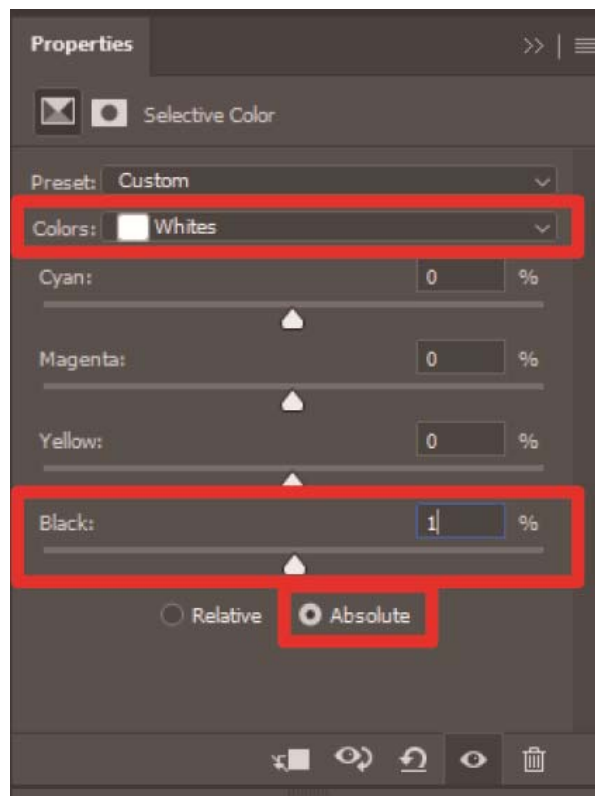

### <TIPS>

- The method to replace RGB=255 with RGB=254 as shown above can be used only when the [Color mode] is set to [8 bit] of [RGB Color].
- For Photoshop, the action file "SolidWhite.atn" is made available in Useful Tools, which changes RGB=255 to RGB=254 (☞ "4-6-2. Replace RGB=255 with RGB=254 (for Photoshop only) >>P.4-49"). For how to use it, refer to the Help feature that Photoshop is provided with.



### 4-3-3. When using Adobe Illustrator

---



In Illustrator, perform the required procedures mentioned below:

- Color setting
- Open a new file

As required, perform the following procedures:

- Create print data (ARX6 file).
- Use the color palette in Useful Tools.

#### <TIPS>

- Take one of the actions mentioned below, in order to avoid such troubles that no image data is inserted into the print range or part of image data is cut off.
  - Before start-up, specify the PC's default printer as the "Brother GTX-6" or the "Brother GTX-6 FileOutput".
  - Use the "Brother GTX-6 FileOutput" printer driver to output a file, then display and check the print preview.
- For an image created in CMYK color mode, load the image into Photoshop, select [Image] > [Mode] in the menu bar, and change the color to the RGB color (sRGB). In order to edit an image, load the image into Photoshop, edit it in the form of bitmap data, or edit it by means of image quality improvements in the printer driver.
  - In the case of print data using white ink  "4-4-10. Set up the image quality >>P.4-36"
  - In the case of print data using color ink and black ink only  "4-5-6. Set up the image quality >>P.4-46"
- For this printer, it is recommended to use Illustrator CC. The display screen is described in Illustrator CC.

## Color setting

- (1) In the menu bar, select [Edit] > [Color Settings].
- (2) Click on the [More Options].
- (3) Ensure selection of the settings as mentioned below, and click [OK].
  - [Settings]: [Custom]
 [Working Spaces]
  - [RGB]: [sRGB IEC61966-2.1]
 [Color Management Policies]
  - [RGB]: [Convert to Working Space]
  - [CMYK]: [Convert to Working Space]
  - [Profile Mismatches]: Mark the [Ask When Opening] and [Ask When Pasting] checkboxes.
  - [Missing profiles]: Mark the [Ask When Opening] checkbox.
 [Conversion Options]
  - [Engine]: [Adobe(ACE)]
  - [Intent]: [Relative Colorimetric]

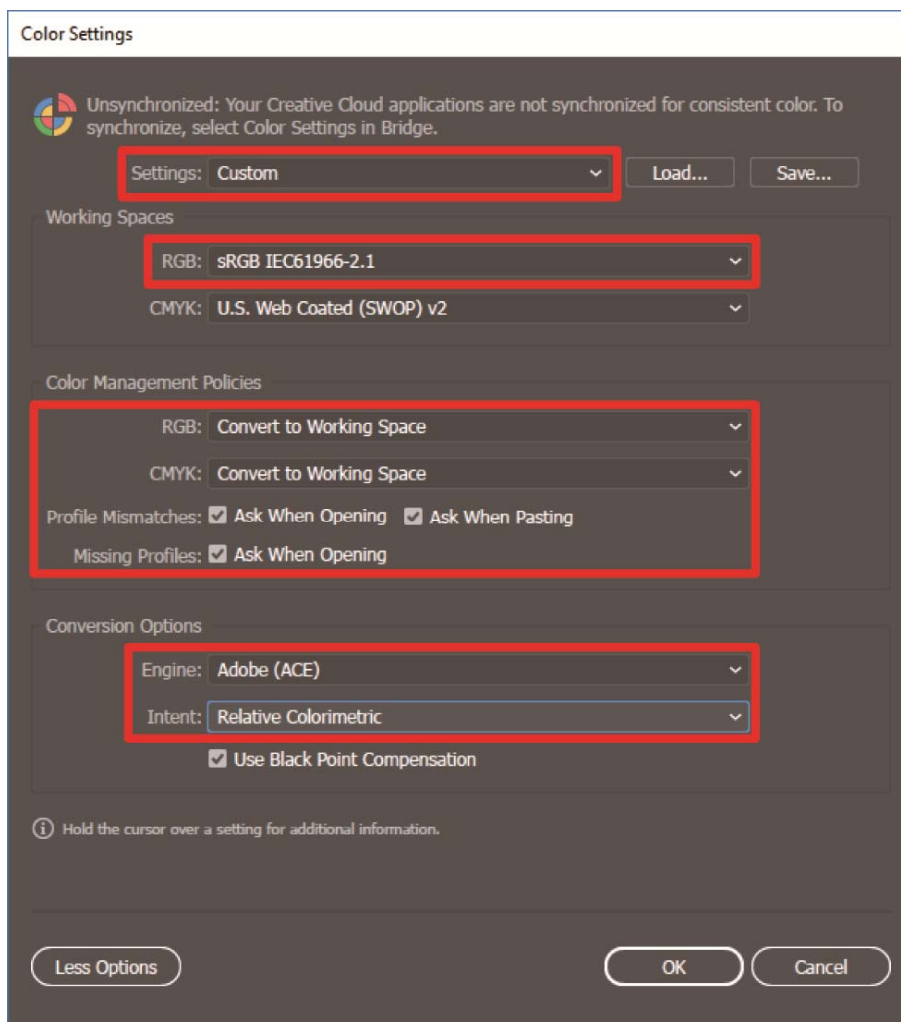



## Open a new file

(1) Set up a new document as follows:

- [Width]: 14.6 in. (370 mm)
- [Height]: 16.5 in. (420 mm)
- [Orientation]: Portrait
- [Color Mode]: [RGB]

### <TIPS>

- Set the width and height to the size of platen to be used. The above size is the standard 14×16 platen size.
  - In the case of print data using white ink  "4-4-2. Select the platen size >>P.4-24"
  - In the case of print data using color ink and black ink only  "4-5-2. Select the platen size >>P.4-41"

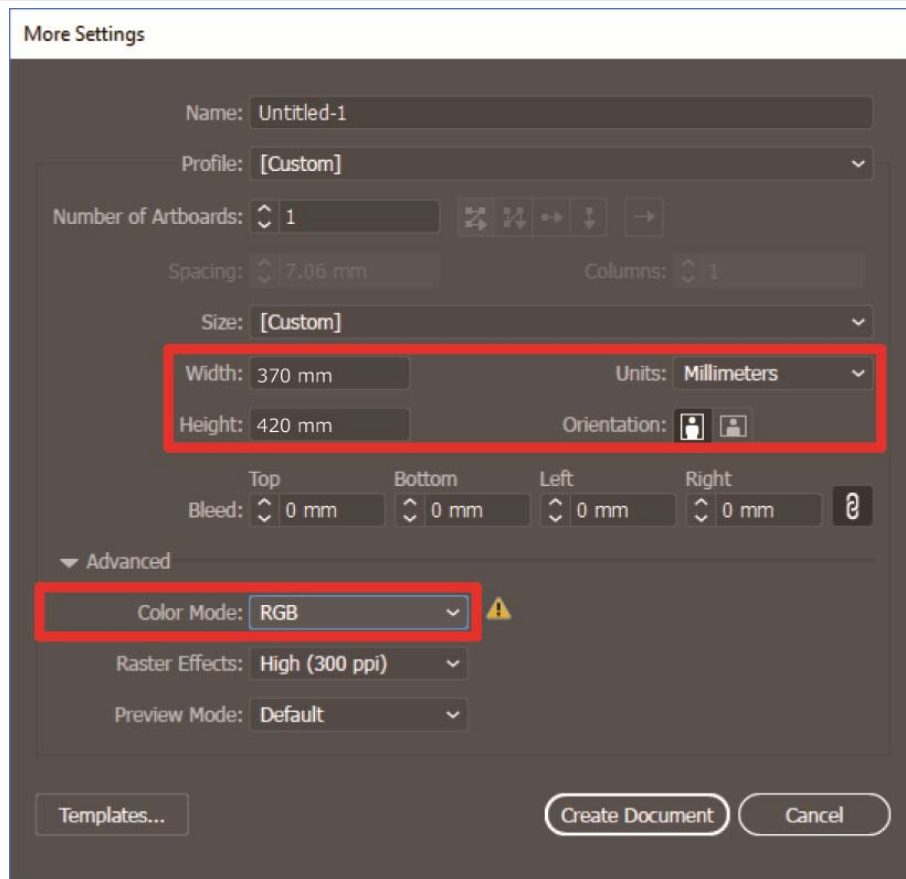

## Create print data (ARX6 file)

Save the image data and print settings as a set of print data in ARX6 file format.

The following will be made available if the print data is converted into an ARX6 file:

- Image data and print settings can be put together and stored.
- Without connection to a PC, the printing can be performed directly from a USB flash memory.

### <TIPS>

- Image editing is unavailable for any ARX6 file. As such, save your image data for an editing purpose in advance.
- For file output, there are some cases where neither file output destination nor extension cannot be specified by the [Print to file] command. Be sure to use the printer driver "Brother GTX-6 FileOutput".
- For details of directly sending data to the printer from an application, see "5-6-2. Sending print data from applications >>P.5-24"

(1) In the menu bar, select [File] > [Print] > [Color Management].

(2) Make the settings as follows:

- [Document Profile]: [sRGB IEC61966-2.1]
- [Color Handling]: [Let Illustrator determine colors]
- [Printer Profile]: [sRGB IEC61966-2.1]
- [Rendering Intent]: [Relative Colorimetric]

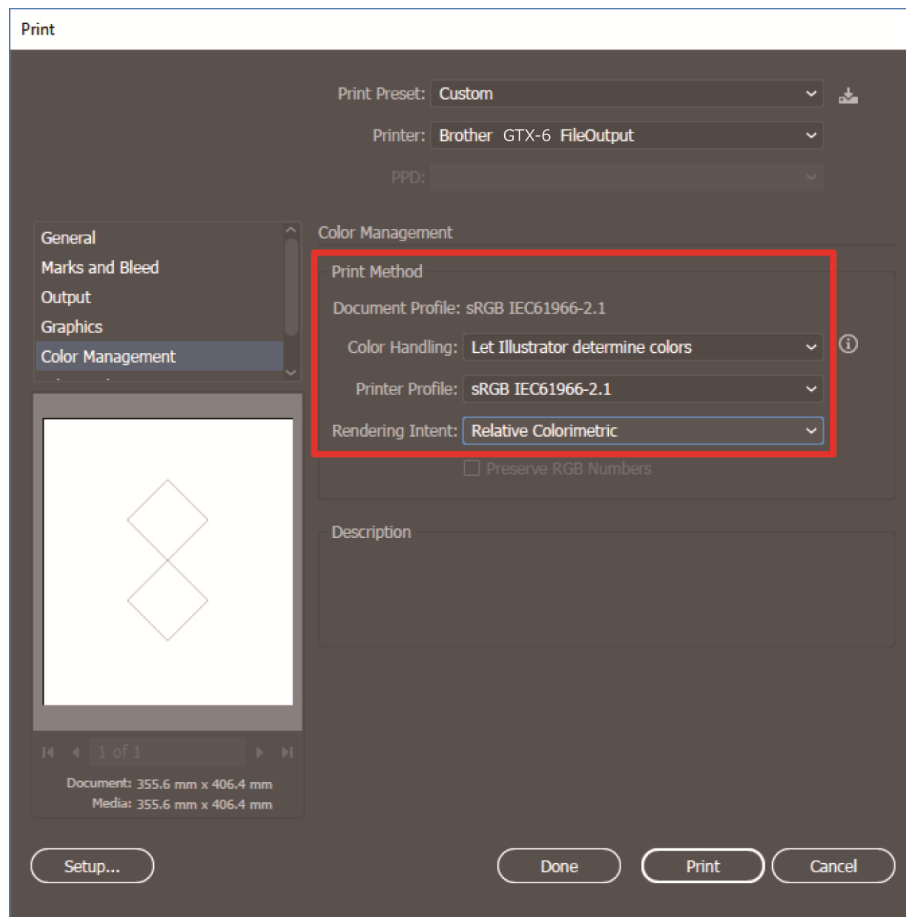

- (3) From [Printer], select "Brother GTX-6 FileOutput" for file output.

<TIPS>

- If [Printer] is set to "Brother GTX-6", the print data will be sent to the printer.  
If [Printer] is set to "Brother GTX-6 FileOutput", the print data will be saved as an ARX6 file.

- (4) On the [Advanced], make your settings for the printer driver.

- In the case of print data using white ink ⇨"4-4-1. Setting up the printer driver >>P.4-22"
- In the case of print data using color ink and black ink only ⇨"4-5-1. Setting up the printer driver >>P.4-39"

<CAUTION>

- For Adobe Illustrator, set the platen size for the paper size in the Print dialog box in the application.  
The size or placement of the image may not be set correctly if you make settings in the Print Settings dialog.

- (5) When you press [Print], the dialog box shown below will be displayed on the screen. After that, click [Save].

<TIPS>

- There may be cases where this saving process takes several minutes.



- (6) Specify the [Save In] and [File name] first, and then click [Save] to save the ARX6 file to your PC.

## Use the color palette in Useful Tools.

- (1) Save the color pallet file for Illustrator, "GT\_Colors\_T.ase", on your PC, following the instructions on screen.
- (2) In the menu bar, select [Window] > [Swatches].
- (3) Click on , and select [Open Swatch Library] from the submenu.
- (4) Select [Other Library].

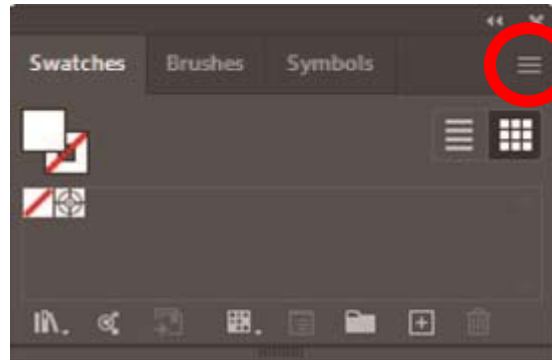

- (5) On the [Open] screen, select the file having such filename as "GT\_Colors\_T.ase".

<TIPS>

- Unlike the Photoshop or CorelDRAW, this Swatch needs to be selected each time a file is opened. However, you can fix the Swatch library in the following method to display the screen automatically whenever you start the application if you are using Illustrator CC.

Click  on the top right corner of the Swatch library and select [Fix] from the submenu.

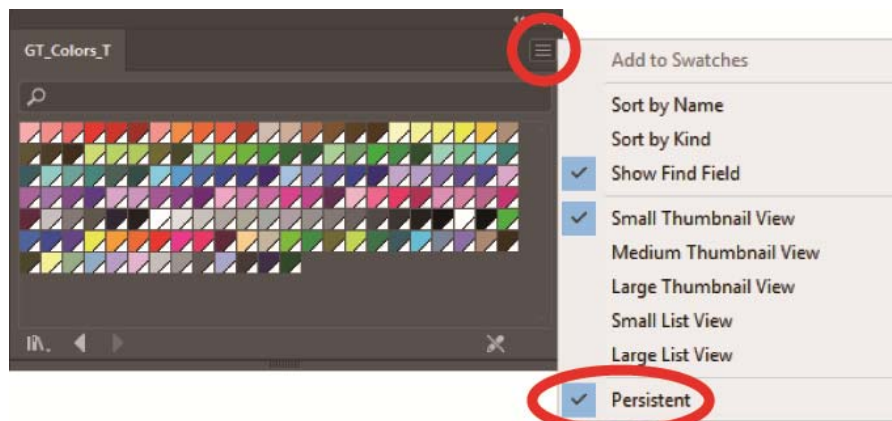

## 4-4. Driver settings for print data using white ink

### 4-4-1. Setting up the printer driver

#### <TIPS>

- The GTX-6 printer driver treats RGB=255 as "Transparent color" and does not eject the ink. For such an image that you wish to print out in pure white color with white ink, make such a setting as RGB=254.
- For the color replacement method, refer to a relevant page (→"4-3. Using other applications >>P.4-4") or help menu of each application software.

- (1) By following the printing procedures of each application software, open the print setup dialog box of the printer driver.

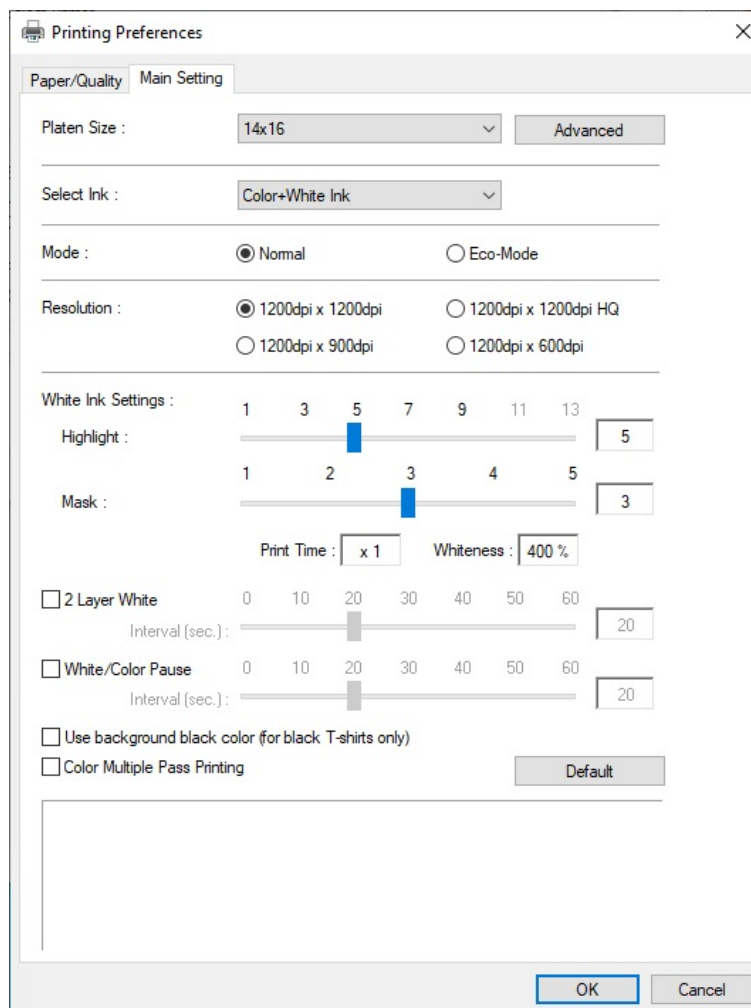

**(2)** In the dialog box for setting the printer driver, configure required settings.

If you click on the [Advanced], [White Ink Settings], [Color Processing], [Color Balance] and [Uni-Directional Printing] can be configured.

**<TIPS>**

- Depending on the settings you have made in the [Select Ink:] option or the like, setup items that appear on the screen vary.
- The rollover help is displayed in the square portion at the bottom of dialog box. Place the mouse pointer over it to browse the help feature.
- For the detailed description of setup items, refer to each chapter mentioned below.

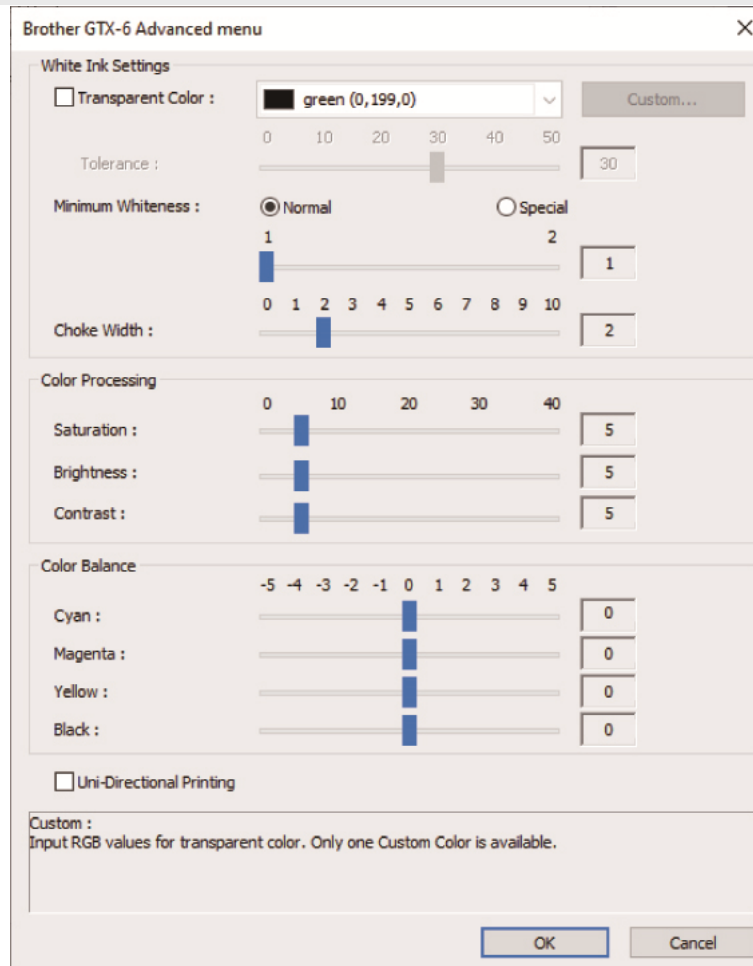
**(3)** After your settings are completed, click [OK].**<TIPS>**

- You can refer to each value you have set up here by opening an ARX6 file from the "GTX-6 FileViewer".



### 4-4-2. Select the platen size

From the pull-down menu of [Platen Size:], select a platen size for print area.

<TIPS>

- The platen size is equivalent to the paper size.

Setup item	Platen to be used	Size
[24×24]	24×24 platen	24.2 in. x 24.2 in. (615 mm x 615 mm)
[18×22]	18×22 platen	18.2 in. x 22.2 in. (463 mm x 565 mm)
[16X18]	16X18 platen	16.5 in. x 18.5 in. (420 mm x 470 mm)
[14X16]	14X16 platen	14.6 in. x 16.5 in. (370 mm x 420 mm)
[10X12]	10X12 platen	10.6 in. x 12.6 in. (270 mm x 320 mm)
[7X8]	7X8 platen	7.3 in. x 9.1 in. (185 mm x 230 mm)

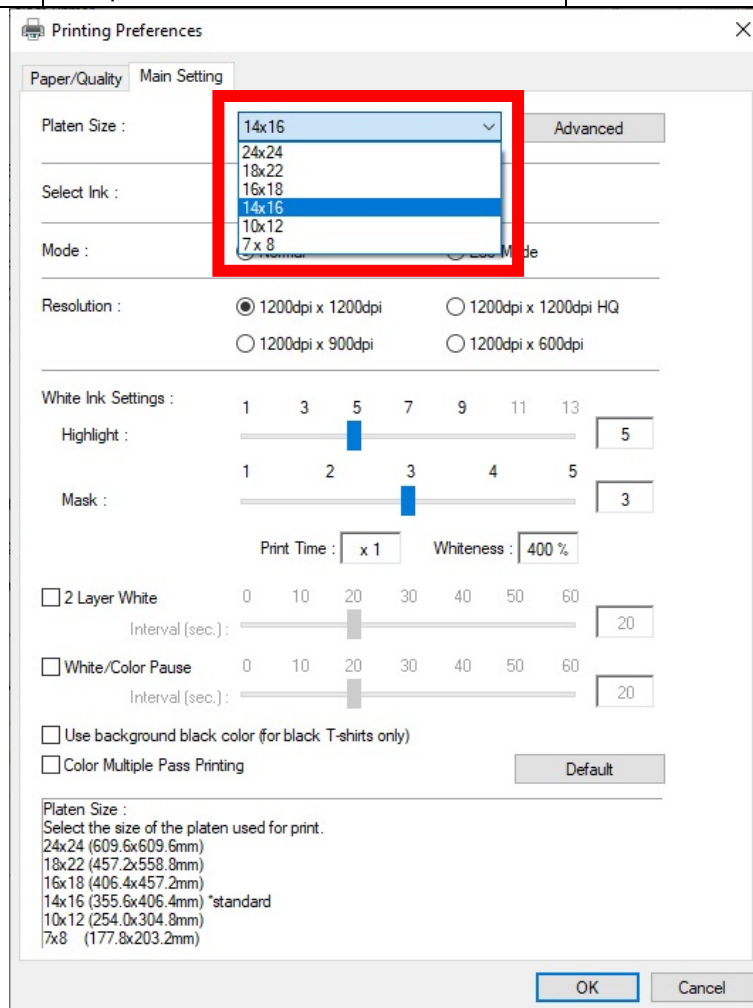

### 4-4-3. Select the ink type

From the [Select Ink:] option, select a combination of inks to be used.

Setup item	Description
[Color+White Ink]	This option enables a color image to be printed out on the mask layer of white ink.
[White Ink Only]	This option enables the white ink only to be used for printing out a monochrome image.
[Color Ink Only]	This option enables a color image to be printed out on a white background or lighter and pale color background.
[Black Ink Only]	This option enables the black ink only to be used for printing out monochrome image.

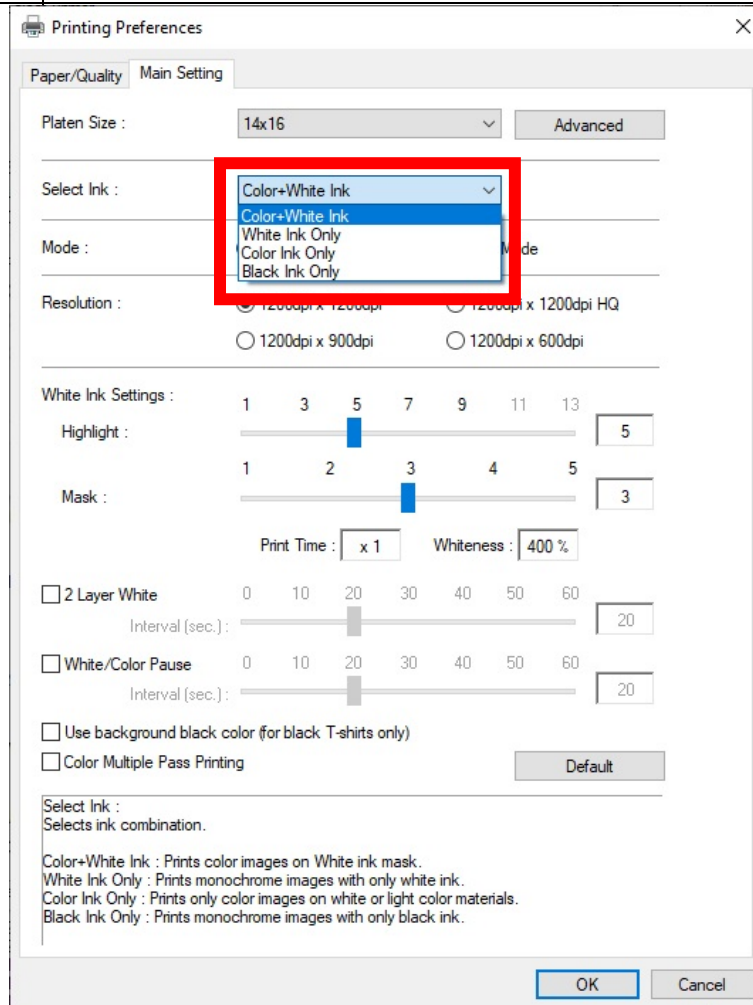

#### 4-4-4. Select the mode

If you set [Mode:] to [Eco-Mode], the white ink volume serving as the background is automatically adjusted to reduce the overall ink consumption.

<TIPS>

- The luminance on the finished print may be slightly reduced depending on the color.

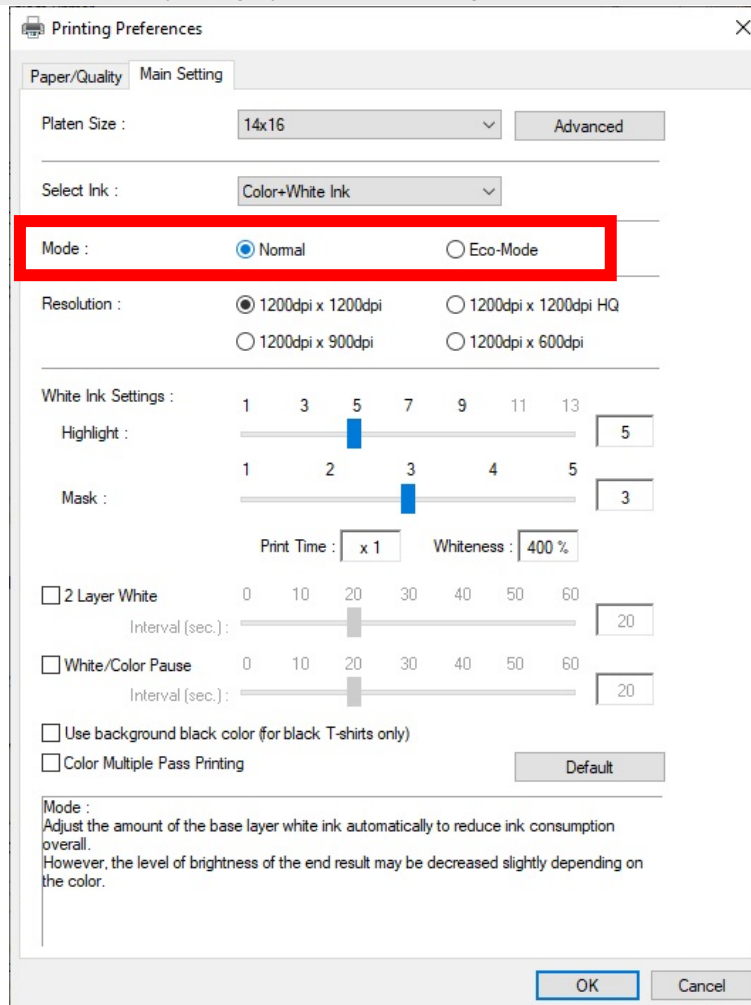

### 4-4-5. Select the resolution

The range that can be set for highlighting will change, and the printing time will also differ, depending on the resolution selected in [Resolution:].

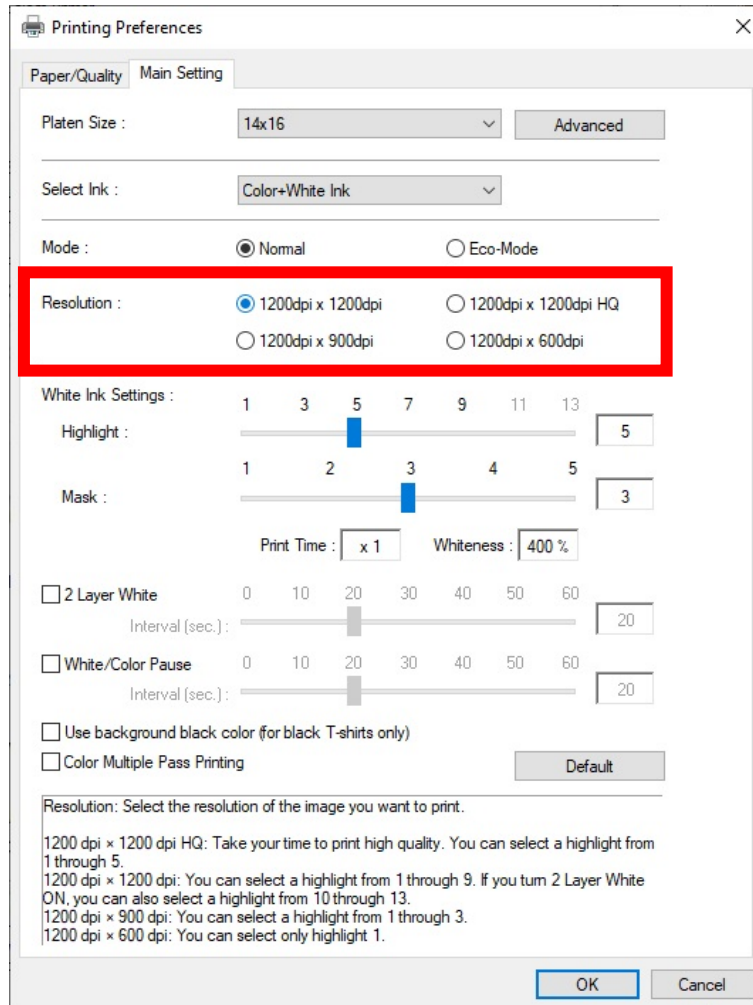

#### Resolution

Resolution	Description
1200dpi × 1200dpi	Prints at 1200 dpi × 1200 dpi.
1200dpi × 1200dpi HQ	Prints at 1200 dpi × 1200 dpi (High Quality Mode). Valid for white + color ink and white ink only.
1200dpi × 900dpi	Prints at 1200 dpi × 900 dpi.
1200dpi × 600dpi	Prints at 1200 dpi × 600 dpi.

#### <TIPS>

- Depending on the settings of [Resolution:], [Print Time:] will change.
- Actual ink consumption depends on the actual colors used in the original image. As such, use this number as a reference for ink consumption.

#### 4-4-6. Set up the white ink

If you have selected [Color+White Ink] or [White Ink Only] in the [Select Ink:], the setup items for [White Ink Settings:] will appear.

Adjust the white ink volume separately in the [Highlight:] (visible white ink volume) and in the [Mask:] (white ink volume to cover the background color).

Also, set the white ink time in the [2 Layer White] and [White/Color Pause].

Printing Preferences

Paper/Quality Main Setting

Platen Size : 14x16 Advanced

Select Ink : Color+White Ink

Mode :  Normal  Eco-Mode

Resolution :  1200dpi x 1200dpi  1200dpi x 1200dpi HQ  
 1200dpi x 900dpi  1200dpi x 600dpi

White Ink Settings :

Highlight : 1 3 5 7 9 11 13 5

Mask : 1 2 3 4 5 3

Print Time : x1 Whiteness : 400 %

2 Layer White 0 10 20 30 40 50 60 Interval (sec.) : 20

White/Color Pause 0 10 20 30 40 50 60 Interval (sec.) : 20

Use background black color (for black + white only)

Color Multiple Pass Printing Default

White Ink Settings :  
 You can set "Highlight" and "Mask" when "Color+White Ink" or "White Ink Only" is selected.

OK Cancel

## Highlight

This enables you to select whiteness (thickness) of RGB=254 in such nine levels as [1] to [13]. When you increase this value, the White ink volume will increase.

You can specify [10] to [13] only if [2 Layer White] is enabled.

Highlight setpoints	Ink volume
[1]	White ink volume 200%
[2]	White ink volume 250%
[3]	White ink volume 300%
[4]	White ink volume 350%
[5]	White ink volume 400%
[6]	White ink volume 450%
[7]	White ink volume 500%
[8]	White ink volume 550%
[9]	White ink volume 600%
[10]	White ink volume 650%
[11]	White ink volume 700%
[12]	White ink volume 750%
[13]	White ink volume 800%

### <TIPS>

- Appropriate highlight setting value depends on color or material of the T-shirt. It is recommended to consider and decide on an appropriate highlight setting value before creating print data. Perform a highlight check pattern print and select an appropriate setting value. ☞"4-6-6. Print out of highlight check pattern/mask check pattern >>P.4-53"
- Depending on the settings of [Highlight:], [2 Layer White], [White/Color Pause], and [Color Multiple Pass Printing], the [Print Time:] and [Whiteness:] will change accordingly.
- [Print Time:] will be set to [×1] if the setup value of [Highlight:] is [5], and [2 Layer White], [White/Color Pause] and [Color Multiple Pass Printing] are turned OFF. With this [X1] serving as a reference value, how many times relates to how long the print time will take when printing.
- Actual ink consumption depends on the actual colors used in the original image. As such, use this number as a reference for ink consumption.

## Mask

This enables you to select the volume of white ink which is used as background color for color inks in such five levels as [1] to [5].

Setup value	Description
[1] or [2]	These setup values are suitable for such lighter and pale background colors as pale pink, ash and cream.
[3]	This is the default value. This value will reproduce the most smooth white-gray-black gradation.
[4]	This value is suitable for vivid background colors, e.g., red, purple, and green. It suppresses the influence of the color of the fabric.
[5]	This value enables the printing with the largest amount of white ink under all colors except darker color areas.

### <TIPS>

- Perform a mask check pattern print and select an appropriate setting value. ☞"4-6-6. Print out of highlight check pattern/mask check pattern >>P.4-53"

## 2 Layer White

You can make highlight settings at a level of [1] to [13] when 2 Layer White is enabled.

Set 0-60 seconds for the time from the start of printing the first white ink layer to the start of printing the second white ink layer.

If you set a time shorter than the time it takes to print the first layer, the additional waiting time will be set to 0 seconds.

### <TIPS>

- Only if you have selected [Color+White Ink] or [White Ink Only] in the [Select Ink:] settings, this setting menu will be enabled.

## White/Color Pause

Set 0-60 seconds for the time from the start of printing the previous white ink layer to the start of printing the color ink layer.

If you set a time shorter than the time it takes to print the previous white ink layer, the additional waiting time will be set to 0 seconds.

### <TIPS>

- Only if you have selected [Color+White Ink] in the [Select Ink:] settings, this setting menu will be enabled.
- Check this checkbox to activate it when you print a tiny image.
- Tiny images may become black when printed. When that occurs, print a white layer first and wait for a while (waiting time) to print the color layers.

#### 4-4-7. Specify whether or not to use the background black color

If you have selected [Color+White Ink] in the [Select Ink:], the setup items of [Use background black color (for black T-shirts only)] will appear.

In the event that you wish to print a black T-shirt making use of the T-shirt's background black color, mark the [Use background black color (for black T-shirts only)] checkbox.

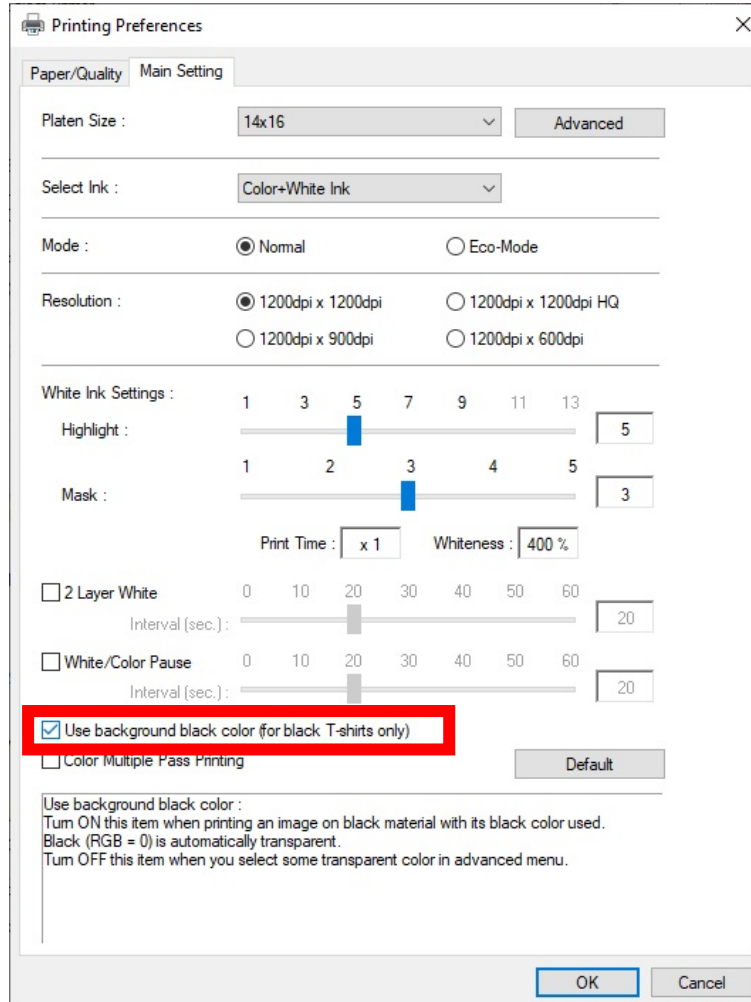



#### 4-4-8. Specify whether or not to perform Multiple Pass Printing

The setup items for [Color Multiple Pass Printing] will appear if you have selected the [Color+White Ink], [Color Ink Only], or [Black Ink Only] in the [Select Ink:].

In cases where small and horizontal stripes are noticeable in the print result, mark the [Color Multiple Pass Printing] checkbox.

##### <TIPS>

- Even if the [Color Multiple Pass Printing] checkbox is marked, the amount of ink to be consumed will remain unchanged.
- It takes longer to complete the print when the [Color Multiple Pass Printing] checkbox is marked. For a typical print time, refer to [Print Time:].

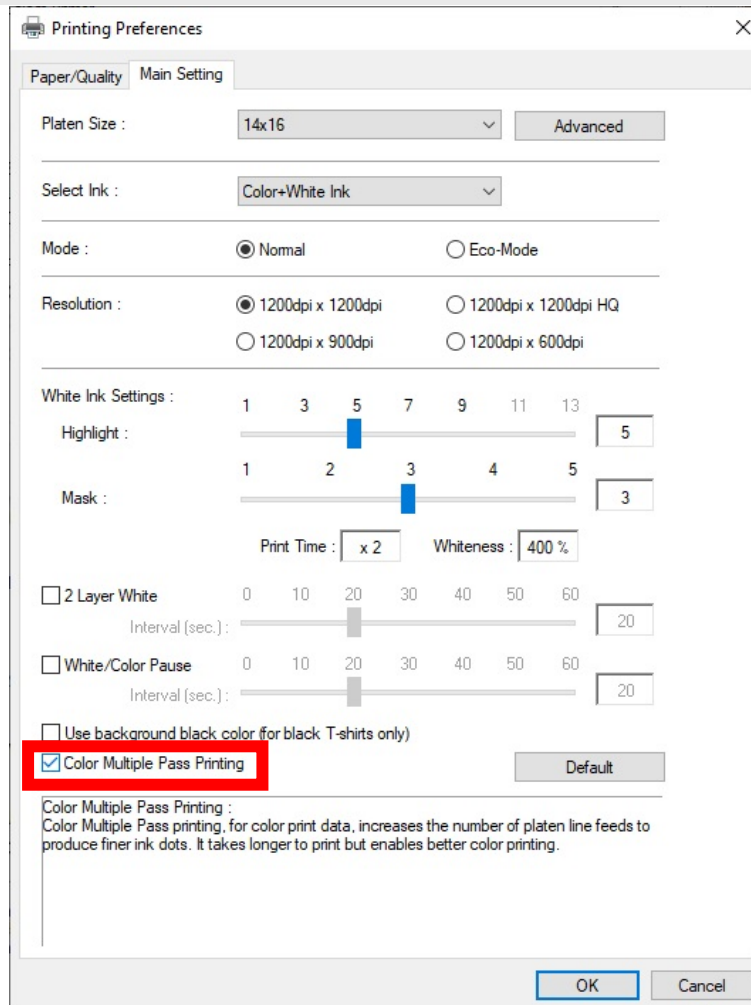

#### 4-4-9. Set up the white ink

If you have selected [Color+White Ink] or [White Ink Only] in the [Select Ink:], this setting menu will be enabled. When you click on the [Advanced] in the [Printing Preferences] dialog box, the setup items of [White Ink Settings] appear.

In the [White Ink Settings], you can make settings for [Transparent Color:], [Tolerance:], [Minimum Whiteness:], and [Choke Width:].

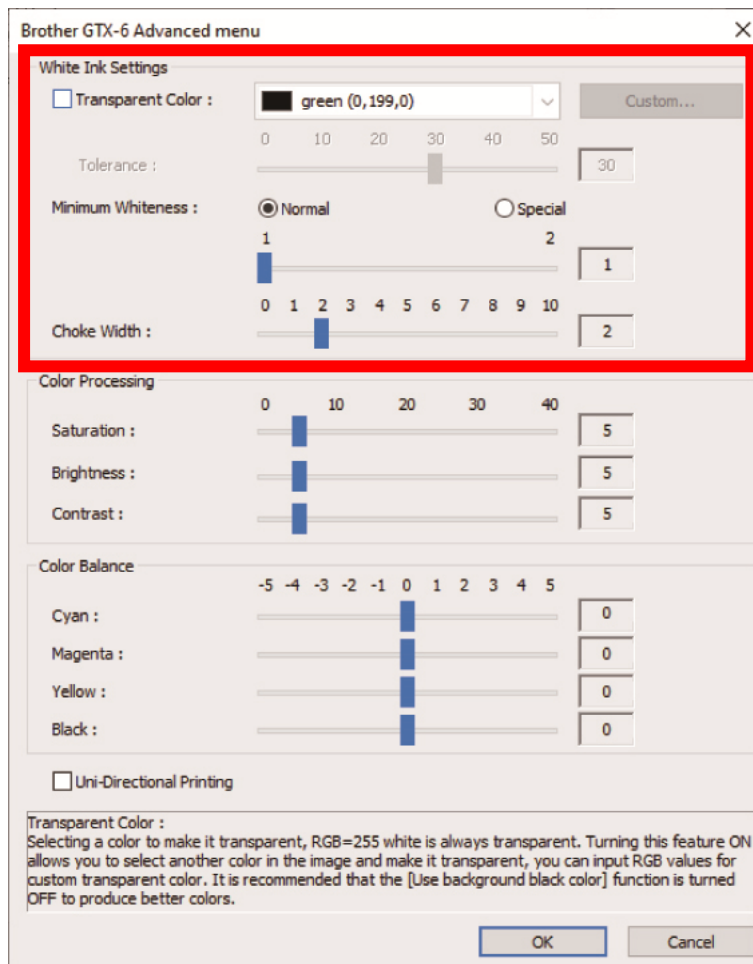

## Transparent color

With this option, specify a color which is treated as a transparent color without using any color during the printing process. If you want to specify other colors excluding the RGB=255 as "Transparent color", perform the following procedures to make your setting.

### <TIPS>

- The RGB=255 is treated as a "Transparent color" (non-printing color).
- You would be better off making [Use background black color (for black T-shirts only)] OFF to produce better colors.

- (1) Click the [Transparent Color:] checkbox.  
Then, the pull-down menu for color selection becomes active.
- (2) In the pull-down menu, select a color which serves as a background color of T-shirt, or click on the [Custom...] to specify a RGB value.

### <TIPS>

- This custom color you have specified is valid only for one color which is specified immediately before. This color cannot be saved in the list.

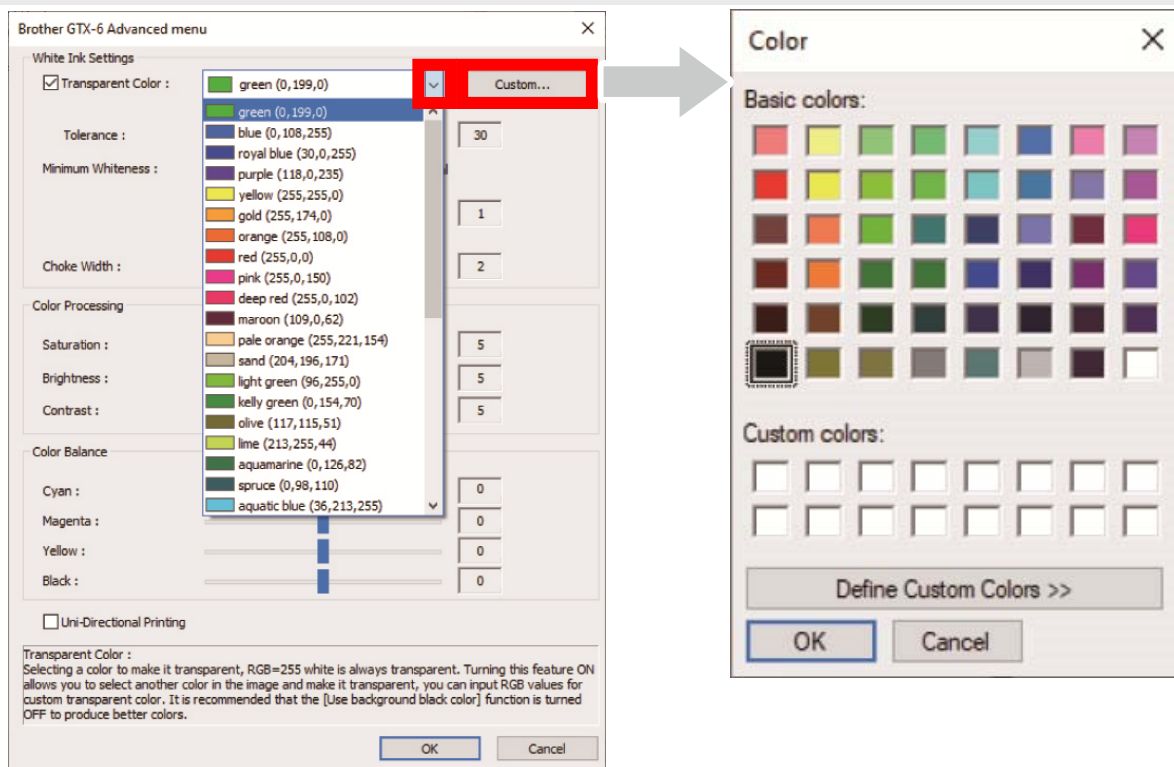

## Tolerance

Specify the gradation range (RGB values) to smoothly connect the zone between "Unprinted color" and "Printed color" to be gradually changed in tone.

### <TIPS>

- If this value is increased, the gradation range in which the mask white is generated from a state in which no mask white exists will increase.
- The gradation's image quality depends on image data. For this reason, it is advisable to perform a test printing beforehand.

### Minimum white ink volume

When printing with [Color+White Ink], the volume of background white color ink for dark or black color ink can be controlled.

When printing with [Color+White Ink], you can increase the amount of the white ink volume used as the base in a dark area by specifying a larger value.

Selecting [Special] allows you to select a value of [3] or higher.

<TIPS>

- The larger the value is, the more likely that blurring occurs.

### White Ink Choke Width

This enables you to select the white ink choke width in such ten levels as [1] to [10]. When you increase this value, the choke width increases. By decreasing the print range of white ink, the white ink will be prevented from extending off from under the color inks.

<TIPS>

- Check the original image if white lines and/or dots are seen around the image, this may be caused by "Anti-alias" bitmap.
- There are instances in which fine lines (characters or photographs) will disappear if this level is increased. For this reason, it is advisable to perform a test printing beforehand.

#### 4-4-10. Set up the image quality

When you click on the [Advanced] in the [Printing Preferences] dialog box, the setup items of [Color Processing] appear. In the [Color Processing] option, you can make settings for [Saturation:], [Brightness:] and [Contrast:]. Make adjustments to increase vividness, brightness and clarity of an image without using any functions of application software.

Setup item	Description
[Saturation:]	The more vivid the color is, the higher its value.
[Brightness:]	The brighter the color is, the higher its value.
[Contrast:]	Contrast makes the image lighter for lighter colors and darker for darker colors if its value increases.

<TIPS>

- If a value of [Contrast:] is increased, there may be some cases in which fine lines will disappear.
- For this reason, it is advisable to perform a test printing beforehand when you specify a higher value.

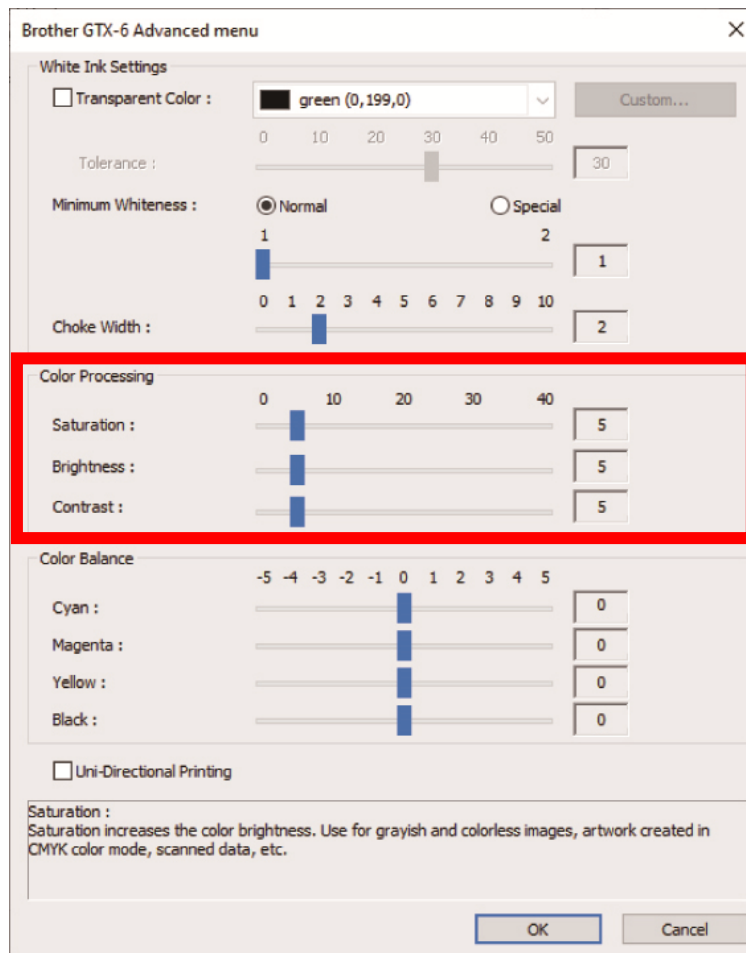

### 4-4-11. Set up the color balance

When you click on the [Advanced] in the [Printing Preferences] dialog box, the setup items of [Color Balance] appear. In the [Color Balance], you can make settings for [Cyan:], [Magenta:], [Yellow:], and [Black:].

You can adjust the color in 11 gradations, -5 to +5.

**<TIPS>**

- If you select [Black Ink Only] for ink selection, you can adjust [Black:] only.

Setup item	Description
[Cyan:]	Adjust the cyan ink volume. If you increase its value, the color becomes light bluish overall. If you decrease its value, the color becomes reddish overall.
[Magenta:]	Adjust the magenta ink volume. If you increase its value, the color becomes reddish-purple overall. If you decrease its value, the color becomes greenish overall.
[Yellow:]	Adjust the yellow ink volume. If you increase its value, the color becomes yellowish overall. If you decrease its value, the color becomes bluish overall.
[Black:]	Adjust the black ink volume. If you increase its value, the color becomes blackish overall. If you decrease its value, the color becomes whitish overall.

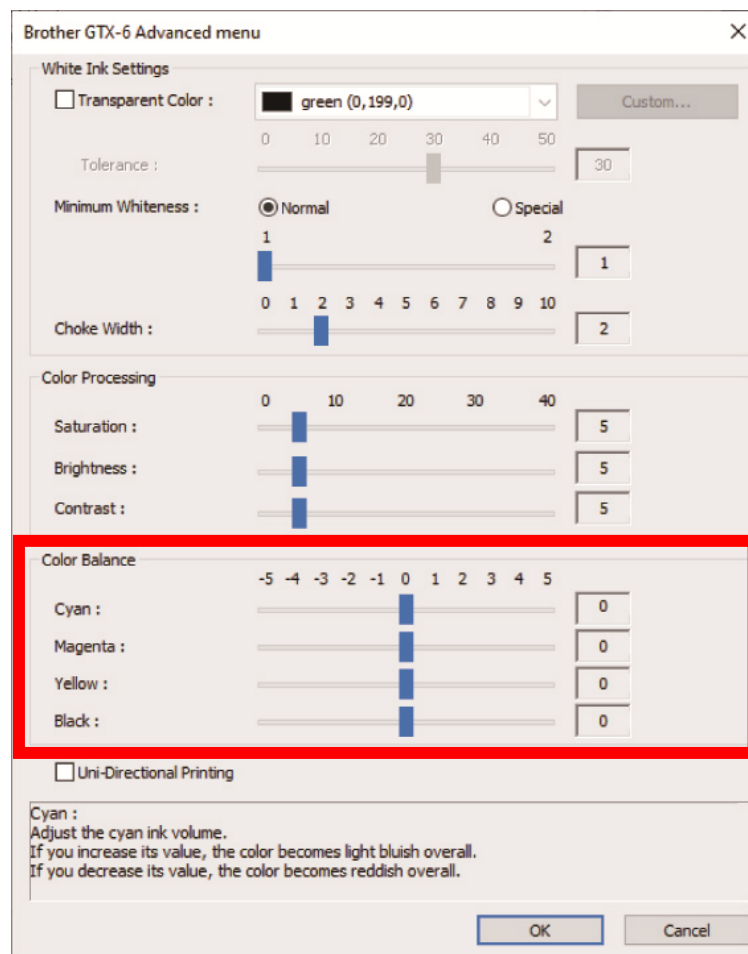

#### 4-4-12. Specify the print direction

When you click on the [Advanced] in the [Printing Preferences] dialog box, you can make the settings for [Uni-Directional Printing].

##### <TIPS>

- What you have specified on the printer's operation panel are prioritized, and this option becomes active only when the print direction specified on the printer side is set to [Auto].
- Print time will be doubled.

Brother GTX-6 Advanced menu

White Ink Settings

Transparent Color : green (0,199,0) Custom...

Tolerance : 0 10 20 30 40 50 [30]

Minimum Whiteness :  Normal  Special

1 2 [1]

Choke Width : 0 1 2 3 4 5 6 7 8 9 10 [2]

Color Processing

Saturation : 0 10 20 30 40 [5]

Brightness : [5]

Contrast : [5]

Color Balance

-5 -4 -3 -2 -1 0 1 2 3 4 5

Cyan : [0]

Magenta : [0]

Yellow : [0]

Black : [0]

Uni-Directional Printing

Uni-Directional Printing :  
Makes the print uni-directional.  
The value of Print Direction set by the Panel has priority. This is available only if [Auto] is selected in Print Direction through the Control Panel.

OK Cancel

## 4-5. Driver settings for print data using color ink and black ink only

### 4-5-1. Setting up the printer driver

#### <TIPS>

- The GTX-6 printer driver treats RGB=255 as "Transparent color" and does not eject the ink. For such an image that you wish to print out in pure white color with white ink, make such a setting as RGB=254.
- For the color replacement method, refer to a relevant page (→"4-3. Using other applications >>P.4-4") or help menu of each application software.

- (1) By following the printing procedures of each application software, open the print setup dialog box of the printer driver.

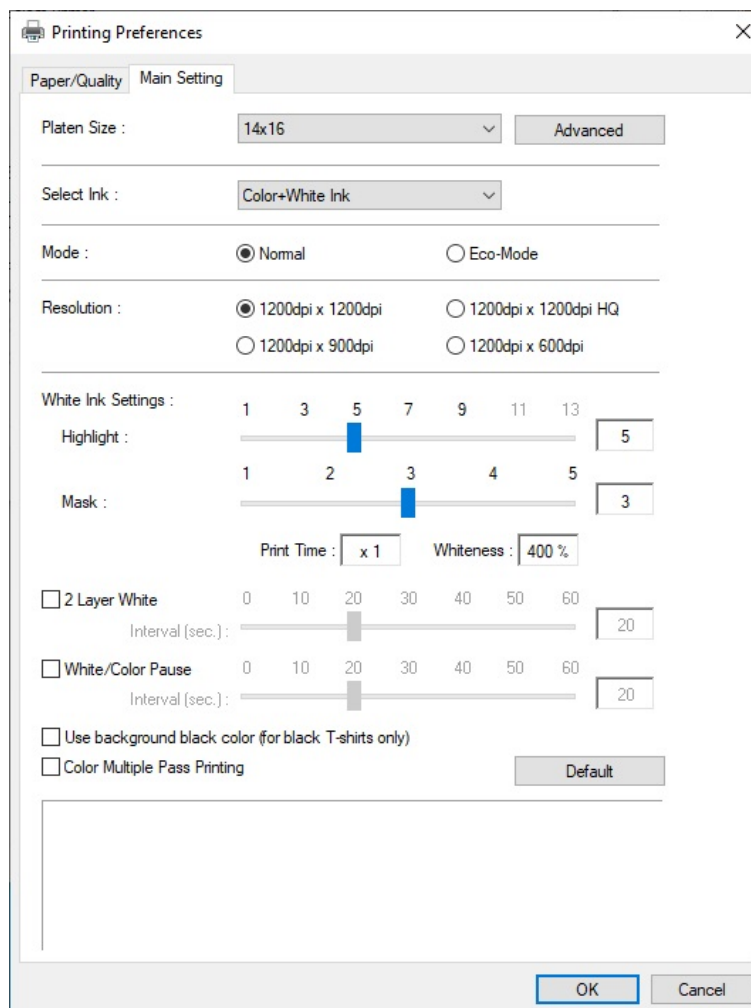



**(2)** In the dialog box for setting the printer driver, configure required settings.

If you click on the [Advanced], [White Ink Settings], [Color Processing], [Color Balance] and [Uni-Directional Printing] can be configured.

**<TIPS>**

- Depending on the settings you have made in the [Select Ink:] option or the like, setup items that appear on the screen vary.
- The rollover help is displayed in the square portion at the bottom of dialog box. Place the mouse pointer over it to browse the help feature.
- For the detailed description of setup items, refer to each chapter mentioned below.

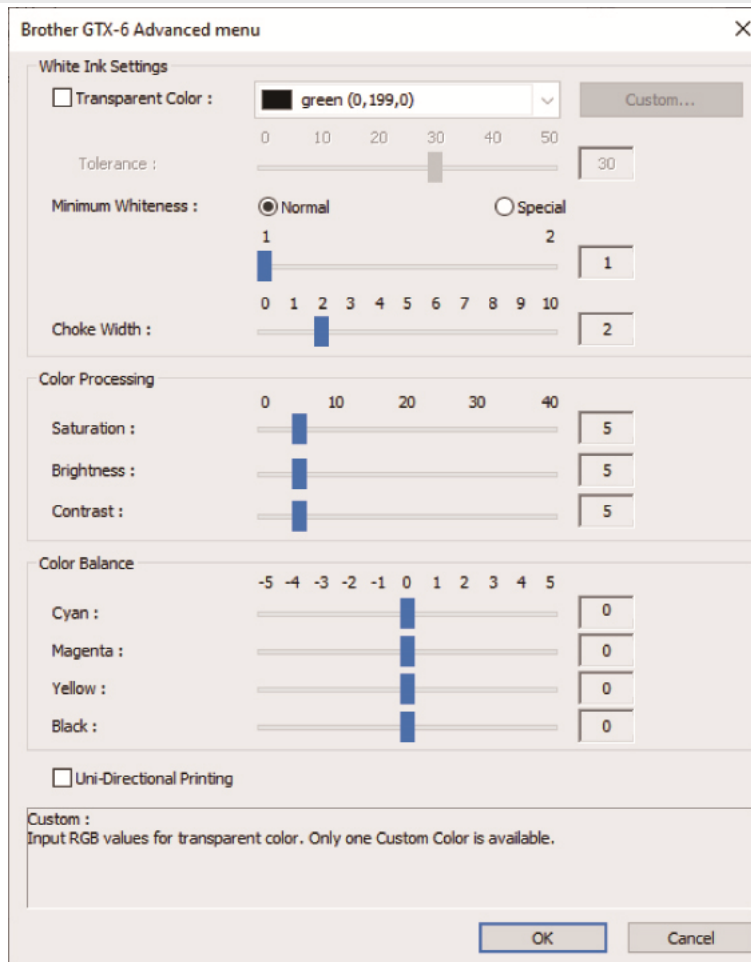
**(3)** After your settings are completed, click [OK].**<TIPS>**

- You can refer to each value you have set up here by opening an ARX6 file from the "GTX-6 FileViewer".

### 4-5-2. Select the platen size

From the pull-down menu of [Platen Size:], select a platen size for print area.

<TIPS>

- The platen size is equivalent to the paper size.

Setup item	Platen to be used	Size
[24×24]	24×24 platen	24.2 in. x 24.2 in. (615 mm x 615 mm)
[18×22]	18×22 platen	18.2 in. x 22.2 in. (463 mm x 565 mm)
[16X18]	16X18 platen	16.5 in. x 18.5 in. (420 mm x 470 mm)
[14X16]	14X16 platen	14.6 in. x 16.5 in. (370 mm x 420 mm)
[10X12]	10X12 platen	10.6 in. x 12.6 in. (270 mm x 320 mm)
[7X8]	7X8 platen	7.3 in. x 9.1 in. (185 mm x 230 mm)

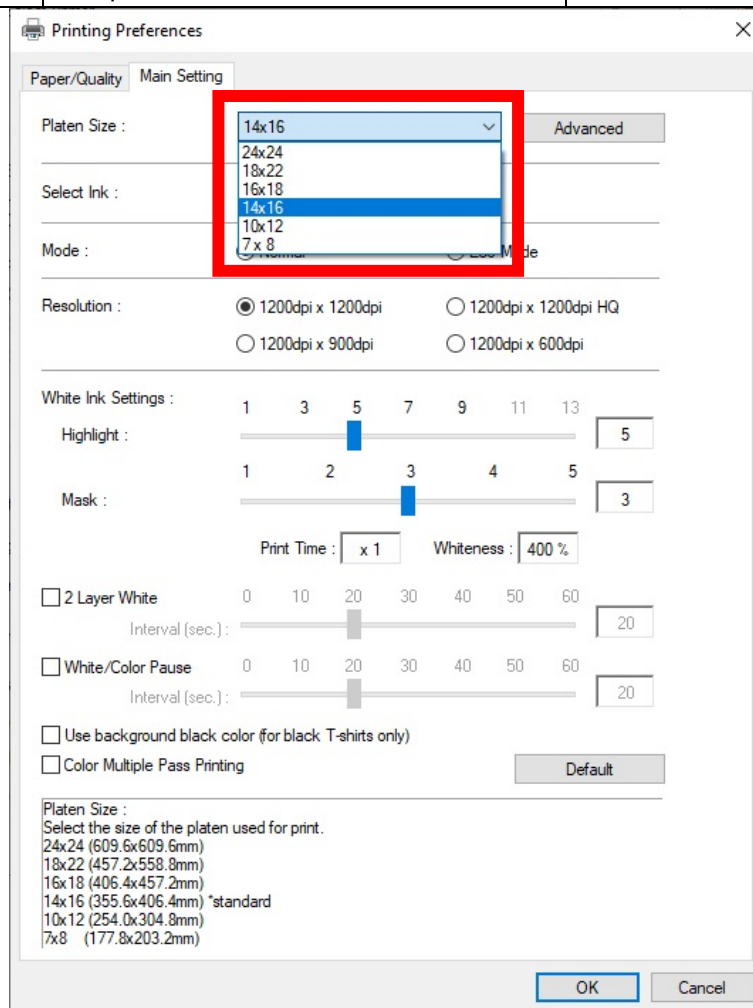

### 4-5-3. Select the ink type

From the [Select Ink:] option, select a combination of inks to be used.

Setup item	Description
[Color+White Ink]	This option enables a color image to be printed out on the mask layer of white ink.
[White Ink Only]	This option enables the white ink only to be used for printing out a monochrome image.
[Color Ink Only]	This option enables a color image to be printed out on a white background or lighter and pale color background.
[Black Ink Only]	This option enables the black ink only to be used for printing out monochrome image.

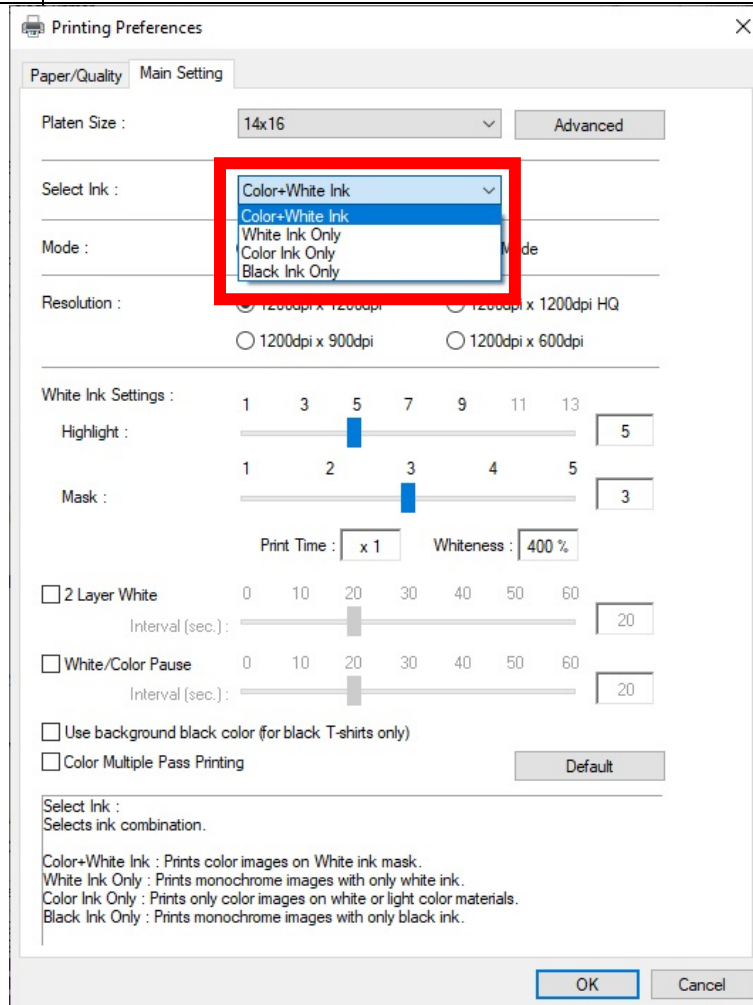

#### 4-5-4. Specify whether or not to perform Multiple Pass Printing

The setup items for [Color Multiple Pass Printing] will appear if you have selected the [Color+White Ink], [Color Ink Only], or [Black Ink Only] in the [Select Ink:].

In cases where small and horizontal stripes are noticeable in the print result, mark the [Color Multiple Pass Printing] checkbox.

##### <TIPS>

- Even if the [Color Multiple Pass Printing] checkbox is marked, the amount of ink to be consumed will remain unchanged.
- It takes longer to complete the print when the [Color Multiple Pass Printing] checkbox is marked. For a typical print time, refer to [Print Time:].

Printing Preferences

Paper/Quality Main Setting

Platen Size : 14x16 Advanced

Select Ink : Color+White Ink

Mode :  Normal  Eco-Mode

Resolution :  1200dpi x 1200dpi  1200dpi x 1200dpi HQ  
 1200dpi x 900dpi  1200dpi x 600dpi

White Ink Settings :

Highlight : 1 3 5 7 9 11 13 5

Mask : 1 2 3 4 5 3

Print Time : x 2 Whiteness : 400 %

2 Layer White 0 10 20 30 40 50 60 Interval (sec.): 20

White/Color Pause 0 10 20 30 40 50 60 Interval (sec.): 20

Use background black color (for black T-shirts only)

Color Multiple Pass Printing Default

Color Multiple Pass Printing :  
 Color Multiple Pass printing, for color print data, increases the number of platen line feeds to produce finer ink dots. It takes longer to print but enables better color printing.

OK Cancel

#### 4-5-5. Set up the color ink

If you have selected [Color Ink Only] or [Black Ink Only] in the [Select Ink:], the setup items of [Color Ink Settings:] will appear.

You can make your setting from the [Ink Volume:] or [Double Printing:] option in the [Color Ink Settings:] window.

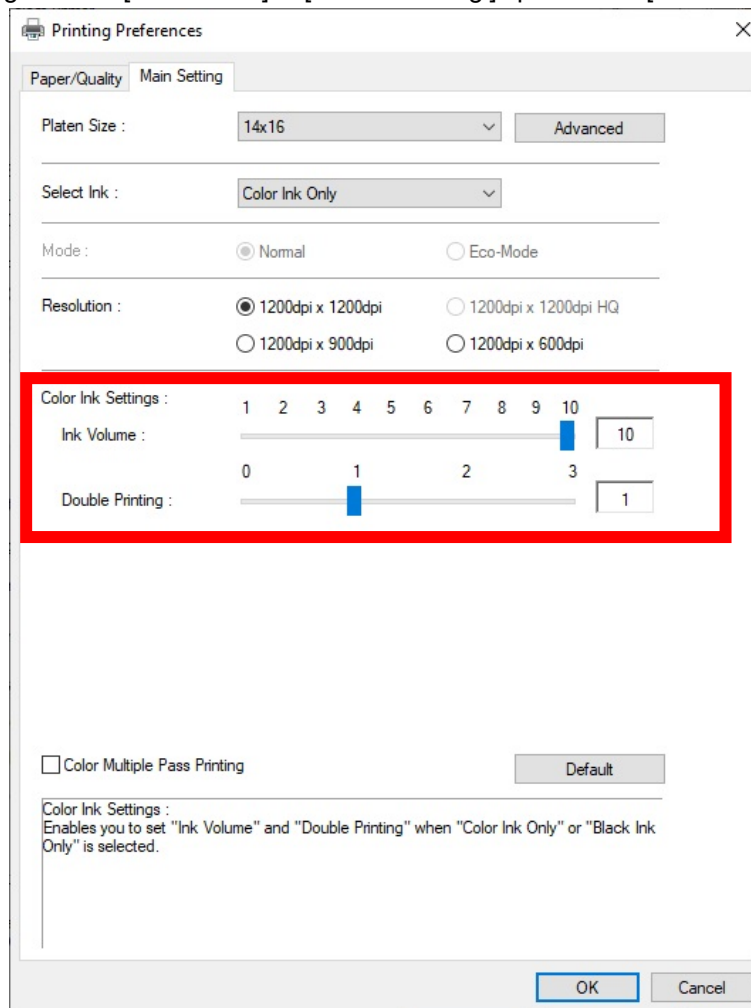

#### Ink volume

This enables you to select the ink volume in such ten levels as [1] to [10].

Setup value	Description
[10]	This is the default value. This value corresponds to 100%-cotton fabrics as well as for blended yarn fabrics (hemp 50%/polyester 50% or cotton 50%/polyester 50%).
[9] to [7]	These values correspond to a thinner T-shirt, thick towel, and cotton products woven with twill fabrics.
[6] to [4]	These values correspond to thin and plain fabrics as well as for blended yarn fabrics that consist of cotton, polyester and polyurethane.
[3] to [1]	These values correspond to polyester jerseys and synthetic fabrics that have no water absorbency.

#### <TIPS>

- When you print other clothes than a thick T-shirt, check on the actual blurring first, then adjust a value in the [Ink Volume:] option.

## Double Printing

Performing the print cycle two times separately will make the printed color stand out more.

Setup value	Description
[0]	No separate processes
[1]	Separate processes (wait time between the 1st and 2nd print cycle)
[2]	Separate processes (longer wait time than the case with setting [1] between the 1st and 2nd print cycle)
[3]	Separate processes (longer wait time than the case with setting [2] between the 1st and 2nd print cycle)

### <TIPS>

- For the options [1] to [3], the platen will reciprocate two times.
- The higher the setpoint is, the longer the print time will be.

### 4-5-6. Set up the image quality

When you click on the [Advanced] in the [Printing Preferences] dialog box, the setup items of [Color Processing] appear. In the [Color Processing] option, you can make settings for [Saturation:], [Brightness:] and [Contrast:]. Make adjustments to increase vividness, brightness and clarity of an image without using any functions of application software.

Setup item	Description
[Saturation:]	The more vivid the color is, the higher its value.
[Brightness:]	The brighter the color is, the higher its value.
[Contrast:]	Contrast makes the image lighter for lighter colors and darker for darker colors if its value increases.

<TIPS>

- If a value of [Contrast:] is increased, there may be some cases in which fine lines will disappear.
- For this reason, it is advisable to perform a test printing beforehand when you specify a higher value.

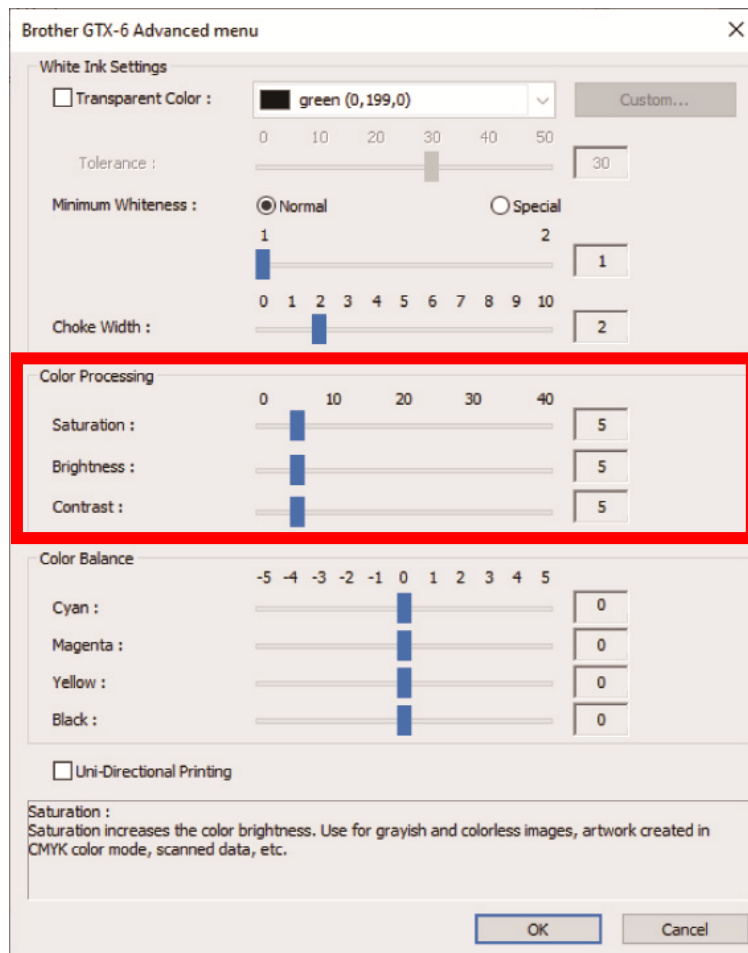

### 4-5-7. Set up the color balance

When you click on the [Advanced] in the [Printing Preferences] dialog box, the setup items of [Color Balance] appear. In the [Color Balance], you can make settings for [Cyan:], [Magenta:], [Yellow:], and [Black:].

You can adjust the color in 11 gradations, -5 to +5.

<TIPS>

- If you select [Black Ink Only] for ink selection, you can adjust [Black:] only.

Setup item	Description
[Cyan:]	Adjust the cyan ink volume. If you increase its value, the color becomes light bluish overall. If you decrease its value, the color becomes reddish overall.
[Magenta:]	Adjust the magenta ink volume. If you increase its value, the color becomes reddish-purple overall. If you decrease its value, the color becomes greenish overall.
[Yellow:]	Adjust the yellow ink volume. If you increase its value, the color becomes yellowish overall. If you decrease its value, the color becomes bluish overall.
[Black:]	Adjust the black ink volume. If you increase its value, the color becomes blackish overall. If you decrease its value, the color becomes whitish overall.

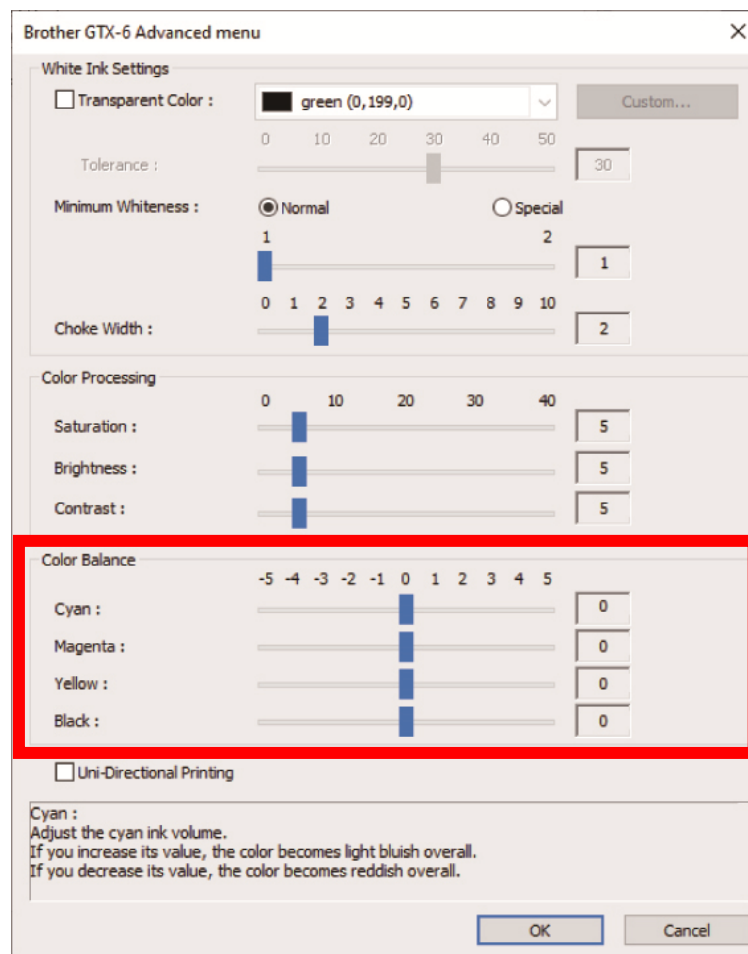



## 4-5-8. Specify the print direction

When you click on the [Advanced] in the [Printing Preferences] dialog box, you can make the settings for [Uni-Directional Printing].

### <TIPS>

- What you have specified on the printer's operation panel are prioritized, and this option becomes active only when the print direction specified on the printer side is set to [Auto].
- Print time will be doubled.

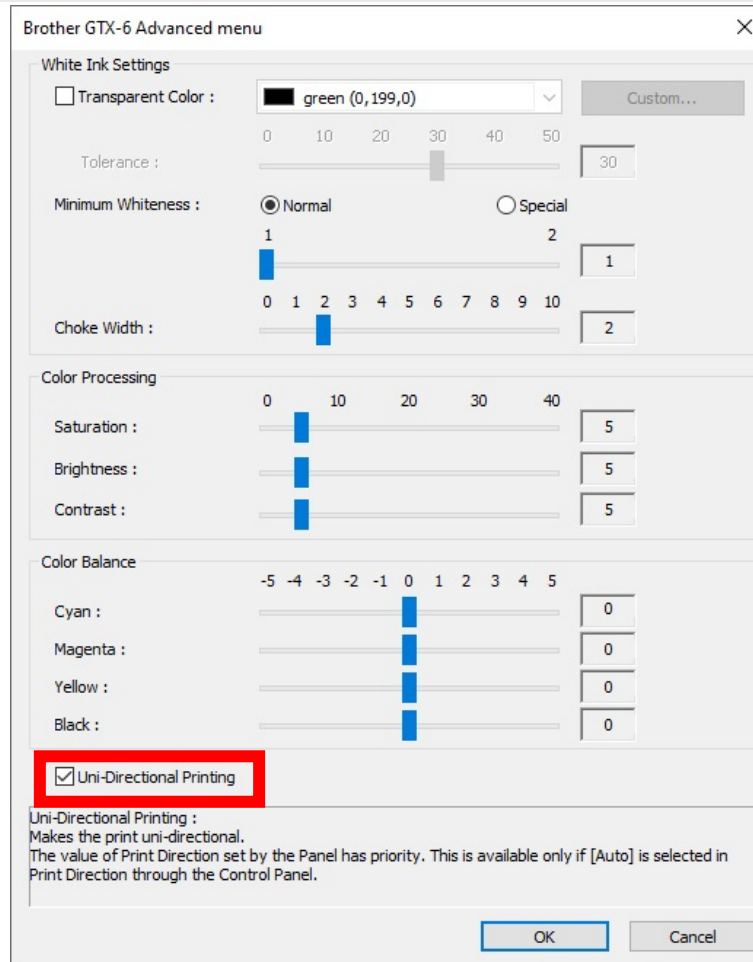

## 4-6. Using Useful Tools

Useful tools and print data are provided for adjusting colors or searching for an appropriate print setting. The "Useful Tools" will be installed onto the subdirectory under the "Brother GTX-6 Tools" of your PC. For the details of each tool, please refer to the chapters described later.

### 4-6-1. Use the color palette

The different color palettes are available for each software application as follows:

- Adobe Photoshop/Illustrator: "GT\_Colors\_T.ase"
- CorelDRAW: "GT\_Colors.xml" and "GT\_Tshirts.xml"

For more information, refer to a relevant page (☞"4-3. Using other applications >>P.4-4") or help menu of each application software.

#### <TIPS>

- When using the printer driver by default, use one of them as a color sample to check color reproduction and create/edit the image data. (Because CorelDRAW cannot contain identical color in the same palette, the color palette is divided into two files.)

### 4-6-2. Replace RGB=255 with RGB=254 (for Photoshop only)

For Photoshop, use this to change RGB=255 to RGB=254.

- (1) From the "Useful Tools", click "SolidWhite.atn", and follow the on-screen instructions to save the file on your PC.
- (2) In the menu bar of Photoshop, select [Window] > [Action file].
- (3) Click on  to open the submenu.
- (4) From the [Load Actions], select "SolidWhite.atn" saved on your PC.

#### <TIPS>

- For information on using action files, refer to the Help feature that Photoshop is provided with.
- "SolidWhite.atn" can be used only when the [Color mode] is set to [8 bit] of [RGB Color].

### 4-6-3. Check the color sample

Use when checking the color sample.

Please use this color chart as a color sample like the one that is commonly provided by an ink maker, for the print data (ARX6 file) you created using your desired printer driver setting.

<TIPS>

- Make use of this color chart when you perform the printing after changing the settings of the printer driver.



(1) From the "Useful Tools", click a required file name to download the data. The following files are provided as color samples.

- GT\_Blues.pdf
- GT\_Greens.pdf
- GT\_Oranges.pdf
- GT\_Reds.pdf
- GT\_ColorChart.pdf

(2) Configure the printer driver and create print data.

<TIPS>

- For details of the printer driver's setting procedures.
  - In the case of print data using white ink ☞"4-4-1. Setting up the printer driver >>P.4-22"
  - In the case of print data using color ink and black ink only ☞"4-5-1. Setting up the printer driver >>P.4-39"
- For information on creating print data, ☞"4-3. Using other applications >>P.4-4"

(3) Send the created print data to the printer and perform printing. ☞"5. Basic printing procedures >>P.5-1"

<TIPS>

- Check the print result and adjust the printer driver's settings.

#### 4-6-4. Print a grid pattern on the platen sheet

You can print a grid pattern onto a new platen sheet.

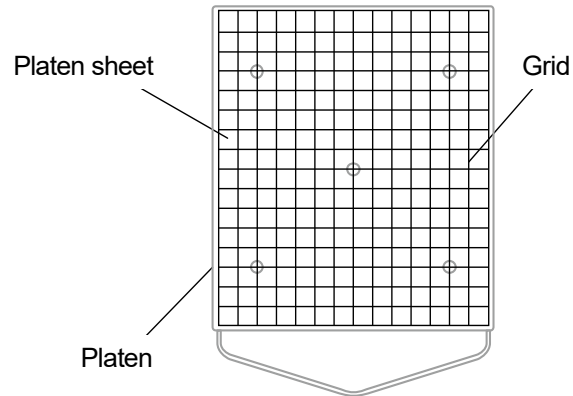

X0163

- (1) From the "Useful Tools", open such an ARX6 file (for example, Grid14×16.arx6) that has a grid size suitable to the platen size.
- (2) Send the print data of grid pattern to the printer.
- (3) Without putting a T-shirt in place, print the grid pattern directly onto the platen sheet.

##### <TIPS>

- After the printing is completed, press down the printed surface lightly with a dry cloth or a sheet of paper to dry the ink.

#### 4-6-5. Adjust the ink volume

Set an optimum setting for [Ink Volume:] of the printer driver.

Download the data from "Useful Tools" and perform printing (☞"5. Basic printing procedures >>P.5-1") to check the blurring beforehand.

<TIPS>

- Appropriate ink volume setting value depends on color or material of the T-shirt. It is recommended to consider and decide on an appropriate ink volume setting value before creating print data.
- There are four types of ink volume printing data. Select the ink volume print data to match the [Double Printing:] setting for the printer driver.

- (1) Select the desired file from "Ink Volume SinglePrint.arx6", "Ink Volume DoublePrint1.arx6", "Ink Volume DoublePrint2.arx6", and "Ink Volume DoublePrint3.arx6" from the "Useful Tools" to download data.
- (2) Send the data to the printer and perform printing.
- (3) Check the print result and adjust the value for [Ink Volume:] of the printer driver.

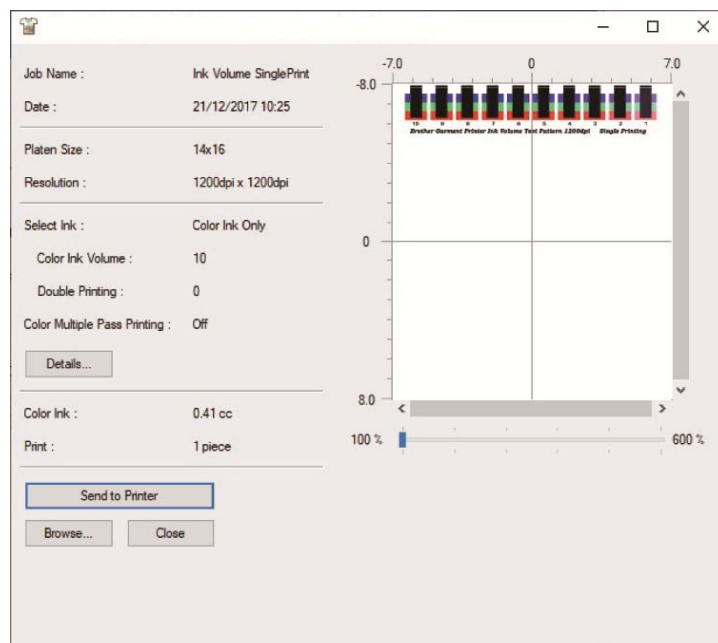

### 4-6-6. Print out of highlight check pattern/mask check pattern

Set an optimum setting for [Highlight:] of the printer driver.

Download the data from "Useful Tools" and print the highlight check pattern for checking whiteness, background hiding level, and blurring beforehand.

<TIPS>

- Please print on a pretreated T-shirt. ☞"5. Basic printing procedures >>P.5-1"
- Appropriate highlight setting value depends on color or material of the T-shirt. It is recommended to consider and decide on an appropriate highlight setting value before creating print data.

(1) From the "Useful Tools", click "Highlight-Mask Check at MW1.zip" or "Highlight-Mask Check at MW2.zip" to download data.

<TIPS>

- The file you should select differs depending on whether "Minimum Whiteness:" is set to [1] or [2].  
Check the number at the end of the file name before downloading the file.

(2) Unzip the file and the following print data will be displayed.

- "HighlightCheckPattern"
- "MaskCheckPattern" at each highlight

(3) Print "HighlightCheckPattern" and select the optimum highlight setting.

(4) Print "MaskCheckPattern" for the optimum highlight setting and select the optimum mask setting.

(5) Check the print result and adjust the values for [Highlight:] and [Mask:] of the printer driver.

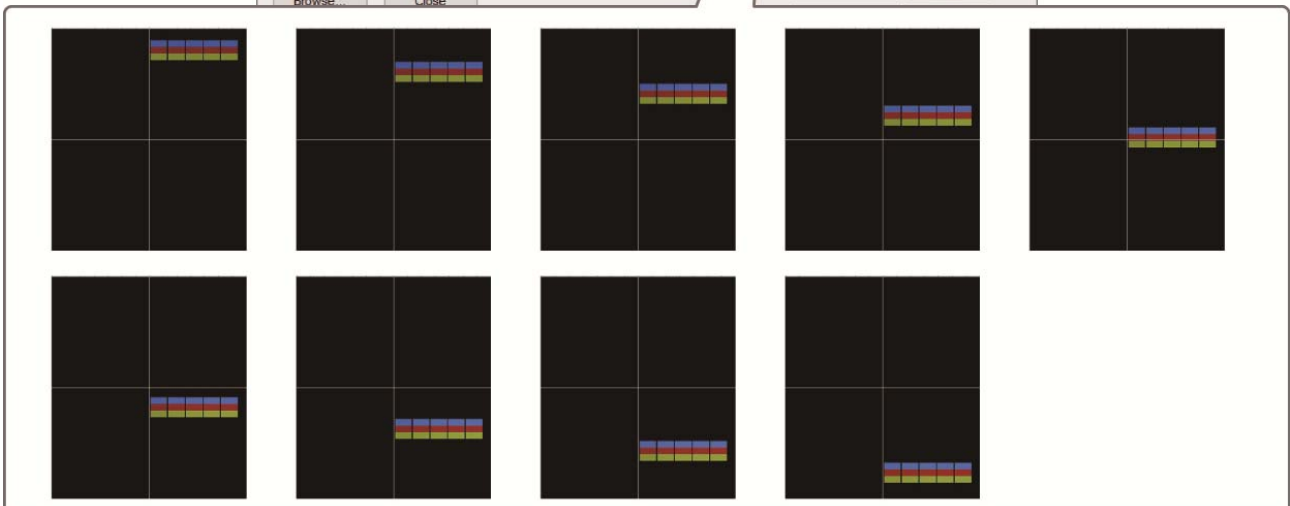
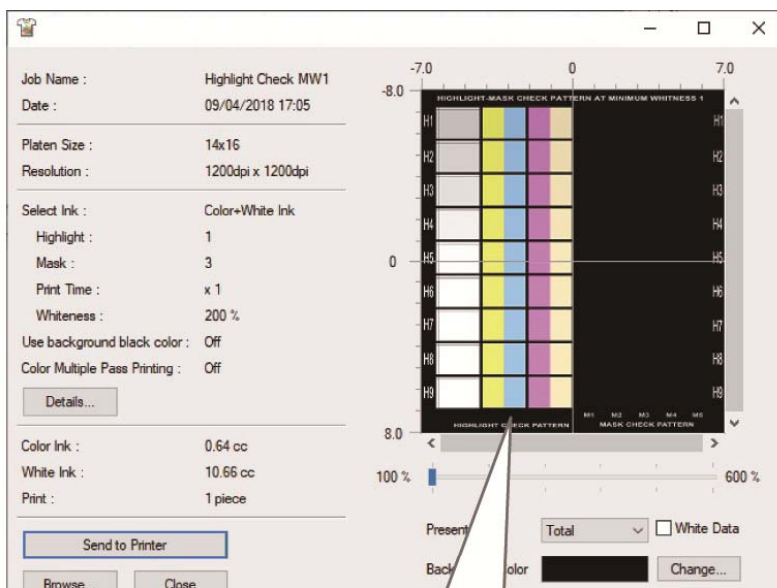

### 4-6-7. Color adjustment for 2 color heads

Check the color adjustment of the color-side heads.

- (1) From the "Useful Tools," click "COLOR ADJUSTMENT.arx6" to download data.
- (2) Send the data to the printer and perform printing.
- (3) Check the print result to make sure the color adjustment has been set correctly.

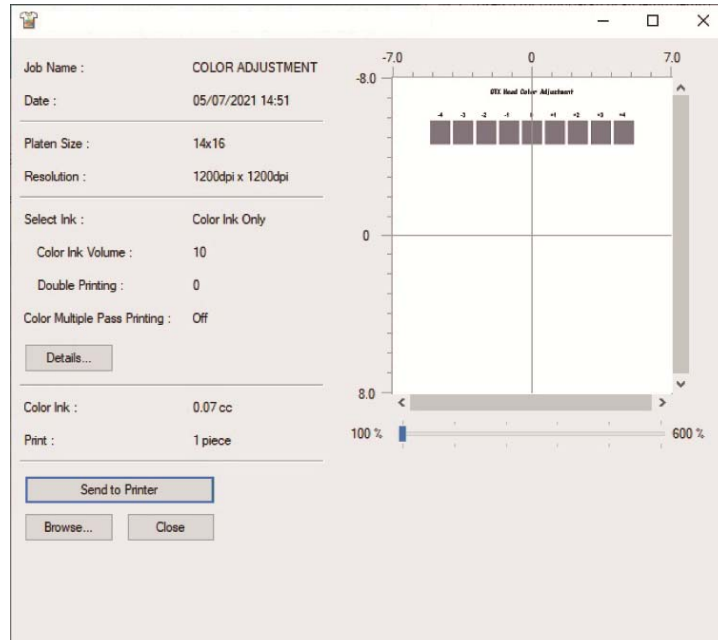

### 4-6-8. Check the ejection timing

Check whether or not the ejection timing is correct.

- (1) From the "Useful Tools", click "FIRING CHK COLOR A.arx6" or "FIRING CHK COLOR B.arx6" or "FIRING CHK WHITE A.arx6" or "FIRING CHK WHITE B.arx6" to download data.
- (2) Send the data to the printer and perform printing.
- (3) Check the print result to make sure the ejection timing has been set correctly.

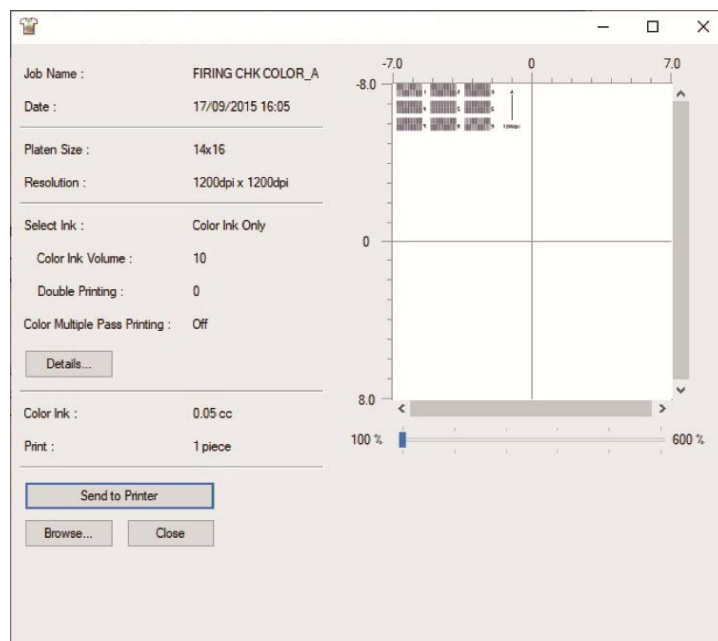

#### 4-6-9. Position adjustment for the 2 heads of the same color

Check the position of the print head.

- (1) From the "Useful Tools," click "HEAD POSITION ADJUSTMENT\_C.arx6" or "HEAD POSITION ADJUSTMENT\_W.arx6" to download data.
- (2) Send the data to the printer and perform printing.
- (3) Check the print result to make sure the position adjustment has been set correctly.

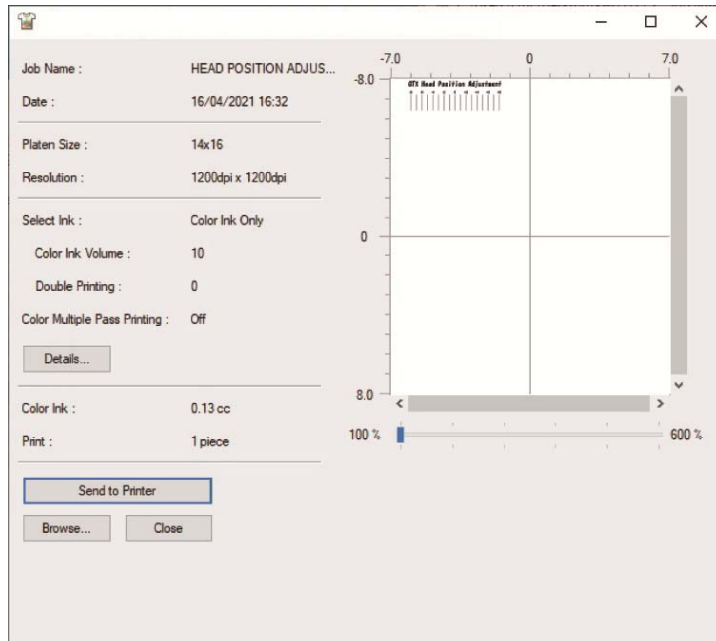

#### 4-6-10. Platen feed adjustment

Check whether or not the platen feed adjustment is appropriate.

- (1) From the "Useful Tools", click "FEEDING PATTERN(1).arx6" to download data.
- (2) Send the data to the printer and perform printing.
- (3) Check the print result to make sure the platen feed adjustment has been set correctly.

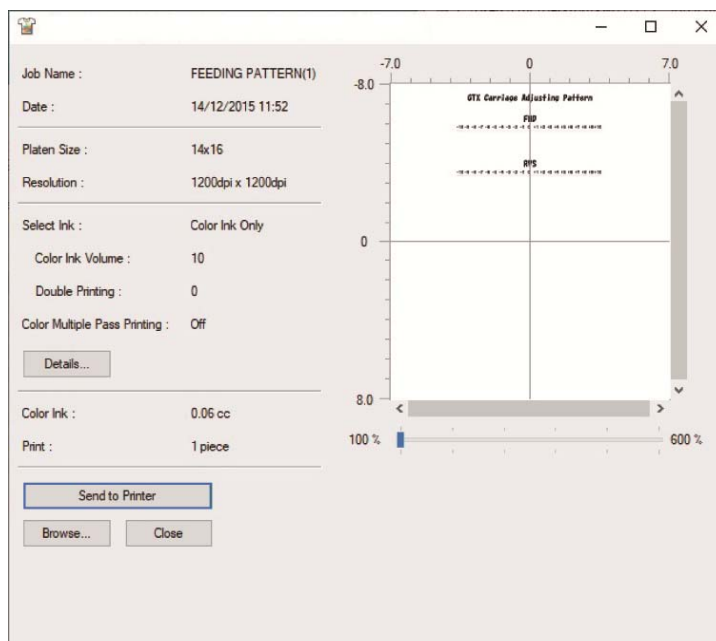



#### 4-6-11. Check the print position

Check the alignment of the print position on the white side with the print position on the color side.

- (1) From the "Useful Tools", click "ALIGN CHK.arx6" to download data.
- (2) Send the data to the printer and perform printing.
- (3) Check the print result to make sure the print position on the white side has been aligned with the print position on the color side correctly.

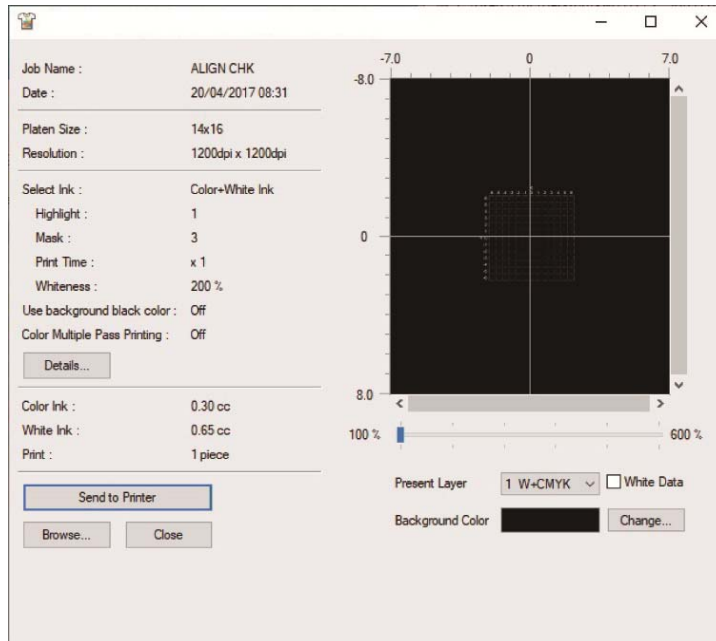

## ! WARNING



If a foreign object gets inside the printer, immediately turn off the power, disconnect the power cord, and contact the place of purchase or a qualified technician. If you continue to use the printer while there is a foreign object inside, it may result in fire or electric shocks or problems with correct operation.



Do not allow the printer to come into contact with liquids. Otherwise it may cause fire or electric shocks or problems with correct operation.



If any liquid gets inside the printer, immediately turn off the power, disconnect the power cord, and contact the place of purchase or a qualified technician.



Do not use the printer when smoke or a bad odor is coming from the printer. Otherwise it may cause fire or electric shocks or problems with correct operation. Immediately turn off the power, disconnect the power cord, and contact the place of purchase or a qualified technician.



Keep your finger or any body part away from the rotating fan. Otherwise it will be caught up, which results in injuries.

Turn off the power when you approach the fan.

## ! CAUTION



This printer should only be used by operators who are appropriately trained in its safe operation.



Ensure there is adequate space left in front of the printer and avoid placing any objects. Otherwise your hand may get caught between the platen and an object, which may result in injury.



Do not handle the platen while printing. If your hand gets caught between the platen or the T-shirt tray and the covers, it may be injured.



Do not put your hands inside the covers while the printer's power is turned on. Otherwise your hands may touch against moving parts and this may result in injury.



Do not drink liquids such as the ink, maintenance solution, cleaning solution, pretreatment, or waste. They may cause diarrhea or vomiting.

When handling liquids, such as the ink, maintenance solution, cleaning solution, pretreatment, and waste ink, use protective glasses and gloves to avoid causing your eyes and skin to contact the liquids. It may cause inflammation. In case of contact with eyes, do not rub but immediately rinse the eyes with water.

Keep the liquids out of the reach of children.



When the pretreatment is applied to printed objects (like a T-shirt) with a spray or pretreatment applicator, sprayed mist is generated. So wear a pair of plastic gloves, a mask and protective glasses (or goggles) designed to shield against liquid splash, and fully take care of the air ventilation when you are working with it.



When a problem occurs with the operation of the printer, contact the place of purchase or a qualified technician.

**((!)) IMPORTANT**



Do not move the platen by hand. Otherwise the printer may be mechanically and electrically damaged.



Ensure there is adequate space left in front of the printer and avoid placing any objects. The platen may be hit and damaged.

## 5-1. Basic printing process flow

What are described below are the basic work flows before the start and after the completion of print process.

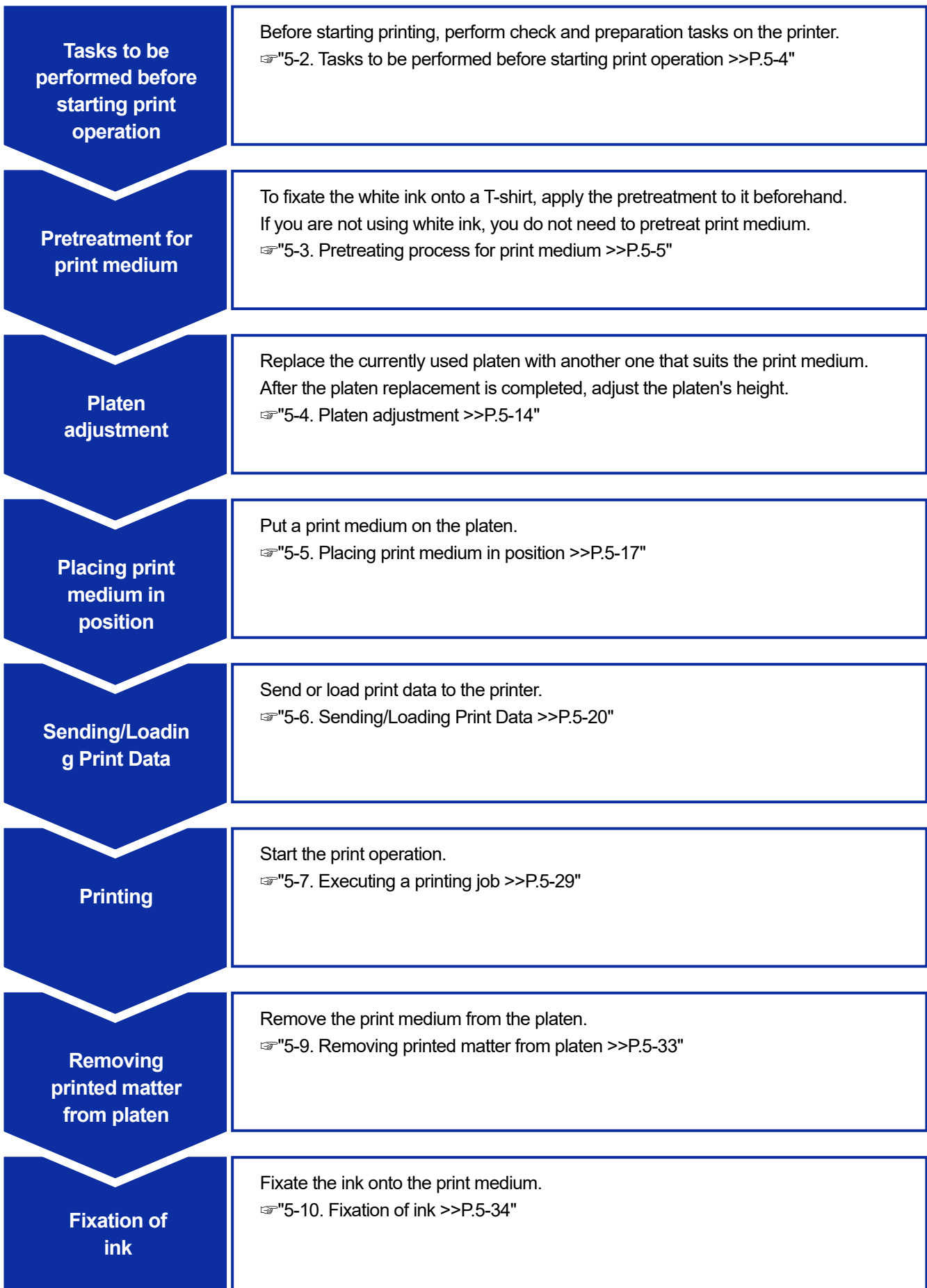

## 5-2. Tasks to be performed before starting print operation

### 5-2-1. Checking the ejection from the head

If a message prompting you to check the ejection from the head is displayed before work, print out a nozzle check pattern.

☞"6-1-17. Print out the nozzle check pattern (checking on the print heads) >>P.6-44"

<TIPS>

- There is no need to agitate the white ink tank manually. However, it is necessary to check the ejection from the head periodically.

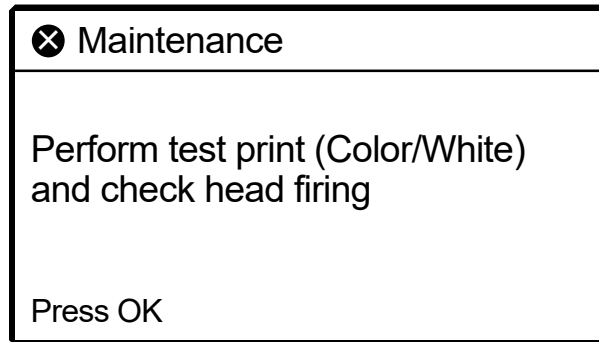

### 5-2-2. Confirmation of Water Supply Tank

Before starting the work, check that the water supply tank has water in it.

### 5-3. Pretreating process for print medium

To fixate the white ink onto the surface of fabric of a T-shirt, apply the pretreatment to it beforehand. If you are not using white ink, you do not need to pretreat print medium.

#### Workflow of pretreating process

Step	Item	Detailed description
1	Dilution of pretreatment	Put the pretreatment into a polypropylene container or the like, and dilute it with pure water.
2	Application of diluted pretreatment	By means of a spray, apply the diluted pretreatment onto the print medium.
3	Fixation of pretreatment	Fixate the pretreatment by using the heat press to apply heat and pressure onto the print medium.

#### 5-3-1. Provisions for pretreatment

##### Items to be prepared

With reference to the table below, make what you need available in advance.

○: What you need △: Useful items, if any
---

Items to be prepared	
Pretreatment	○
Pretreatment	○
Weighing instrument	○
Spray	○
Heat press	○
Peel-off sheet	△
Silicone foam (of open-cell structure)	△
Adhesive roller	△

- Pretreatment

It is the white liquid that is needed for pretreating process for printing with white ink. If a print medium is not coated with this agent, no color development of white ink takes place, and the whiteness becomes insufficient. Also, no color will be produced from the color inks that are applied onto the white ink. Use a spray to apply the pretreatment onto a T-shirt and the heat press to fixate it.

##### <CAUTION>

- Be sure to wear a pair of plastic gloves, a mask and protective glasses during the work operation.
- For information on handling of the pretreatment, see the Material Safety Data Sheet issued by us.  
<http://sds.brother.co.jp/sdsapp/index.html>

- Pretreatment

It refers to distilled water, purified water, etc. which is used to dilute the pretreatment with it.

- Spray (Commercial product)

This is used to apply the pretreatment onto a T-shirt. Use a spray (preferably of an electrically-operated type) that can emit fine spray. A spray allows for easy and even coating and reduces non-uniform coating, while it requires a special space for using it.

In addition to a spray, a pretreatment applicator (commercial product) is available that can apply the pretreatment onto a T-shirt automatically. As required, make them available for use separately.

<CAUTION>

- Fully take care of the air ventilation when you are in operation that generates mist, such as spray application.
- Be sure to wear a pair of plastic gloves, a mask and protective glasses (or goggles) designed to shield against liquid splash during the work operation.
- For information on handling of the pretreatment, see the Material Safety Data Sheet issued by us.  
<http://sds.brother.co.jp/sdsapp/index.html>

<IMPORTANT>

- If you are using an electric spray to apply the pretreatment, perform the work at a place as far as possible from the printer. Otherwise, it may cause failure of print heads.

- Heat press

It must deliver the performance through which the print range of the platen can be covered and 180°C (356°F) can be kept for 35 seconds or more. At a fixing stage of the pretreatment, be sure to use the heat press, but not an oven, to smoothen the surface.

- Peel-off sheet

When using the heat press, place this sheet on a T-shirt so that neither inks nor pretreatment can be attached to the press surface of the heat press. As a peel-off sheet, use a silicone-coated paper or a fluororesin sheet.

There is a tendency to bring the print result to an almost matte finish if a silicone-coated paper is used at the ink fixation stage. There is a tendency to bring the print result to an almost bright finish if a fluororesin sheet is used at the ink fixation stage.

- Silicone foam (of open-cell structure)

It is the foamed mattress which is made of silicone that resists heat. When fixating the inks or pretreatment by means of the heat press, use this foam to ventilate steam with ease.

- Adhesive roller

Use these to remove lint from a T-shirt or debris from its surface.

- T-shirt (printing medium)

100%-cotton fabric or polyester blended yarn fabric (cotton 50% or more)

<TIPS>

- Although it is advisable to use a 100% cotton T-shirt, some textiles cannot necessarily guarantee good printing quality even if they are made of 100% cotton or blended yarn. In particular, for a T-shirt made of new material, perform a printing test on it beforehand.
- Some textiles may leave noticeable imprints of the pretreatment after it is fixated. In that case, wash them away with water.
- Perform a printing test beforehand. Then, the following phenomena may occur:
  - The textiles may be discolored by the pretreatment and cannot be restored to the original color even if they are washed.
  - A deep-colored polyester blended yarn fabric dissolves dye, which may cause the white ink to change to a slightly different color.
  - It is likely that a textile may become yellowish in color after the pretreatment is fixated.

### 5-3-2. Dilution of pretreatment

Be sure to use the pretreatment after diluting it with pure water.

#### <CAUTION>

- Be sure to wear a pair of plastic gloves and protective glasses during the work operation.
- For information on handling of the pretreatment, see the Material Safety Data Sheet issued by us.

<http://sds.brother.co.jp/sdsapp/index.html>

#### Dilution ratio

Use within the ratio range of x3 (Pretreatment:Pure water=1:2) (Volume ratio).

#### Dilution method

##### <TIPS>

- The figure below is based on the pretreatment (20 kg (44 lb)). When using the pretreatment (5 kg (11 lb)), remove the cap and pour the agent into the container, and dilute it with pure water, referring to step (4) and the subsequent steps. Dilution ratio is the same.

- (1) Unpack the pretreatment container from the shipping carton by cutting off the perforated paper along the perforated tear-off line to open the carton.

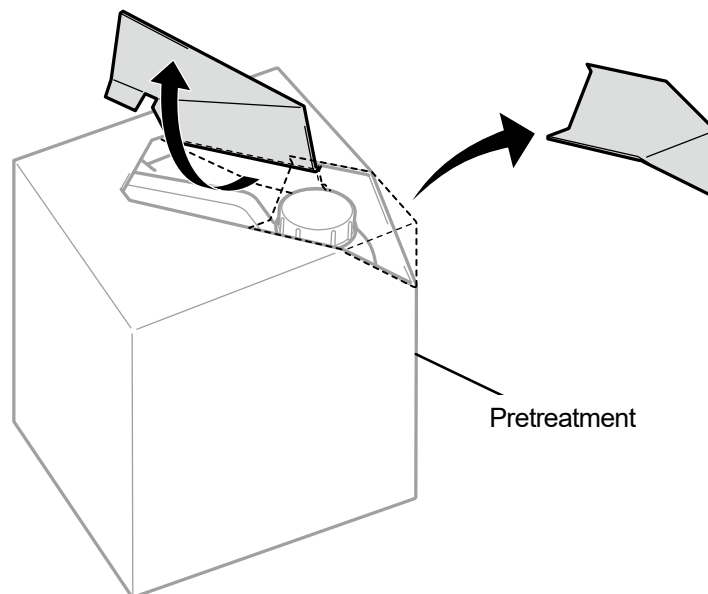

X0079

- (2) Remove the cap, and place the cap in position.

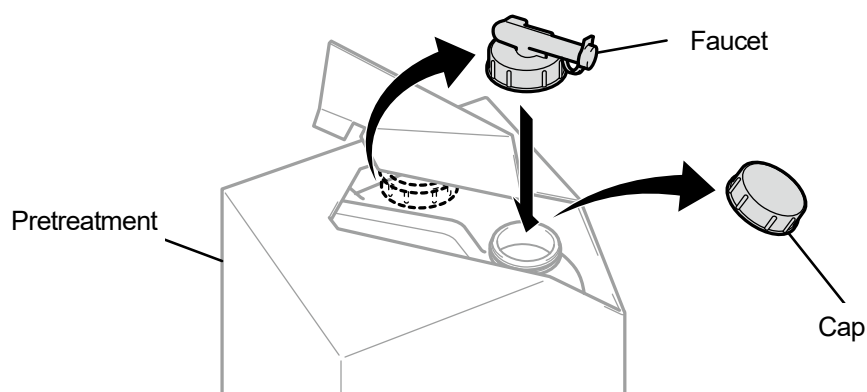

X0080



- (3) Orient the pour spout of faucet in the position as shown in the figure below.

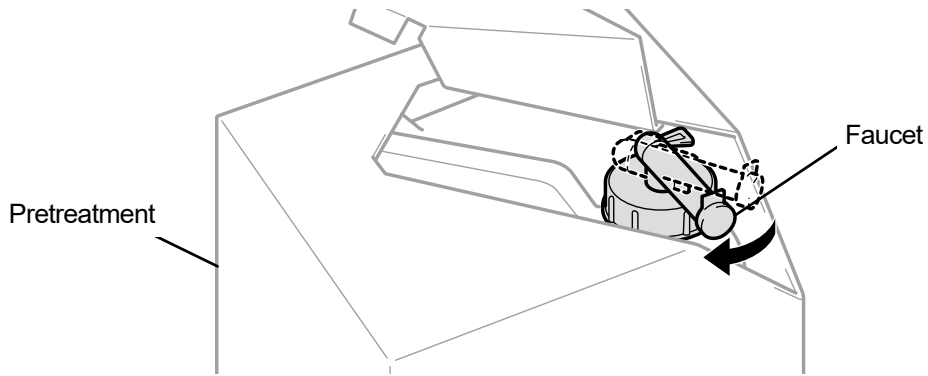

X0081

- (4) Pour the pretreatment with the carton into the container for dilution and dilute the pretreatment with pure water.

<IMPORTANT>

- Dilute the pretreatment three times (pretreatment with pure water at the ratio of 1:2 by volume).
- Close the lid of the container for dilution and stir the content well to make the concentration uniform.

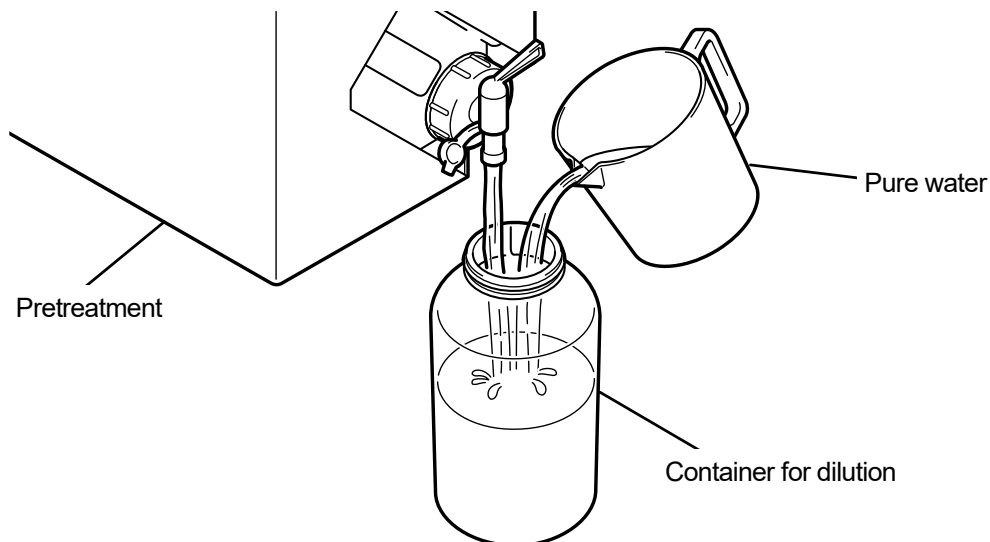

X0082

- (5) To provide safekeeping for the pretreatment, close the faucet, place the pretreatment with the faucet part facing upward, and store the entire carton in a safe place.

### 5-3-3. Application of pretreatment

In order for the pretreated portions to be printed with inks, apply the pretreatment evenly to a wider area than the print range.

#### <CAUTION>

- Fully take care of the air ventilation when you are in operation that generates mist, such as spray application.
- Be sure to wear a pair of plastic gloves, a mask and protective glasses (or goggles) designed to shield against liquid splash during the work operation.
- For information on handling of the pretreatment, see the Material Safety Data Sheet issued by us.  
<http://sds.brother.co.jp/sdsapp/index.html>

#### <IMPORTANT>

- Some T-shirts may leave distinct imprints of the pretreatment after it is fixated. Wash away any imprint of the pretreatment with water, if any.  
Also, some T-shirts may be discolored by the pretreatment and cannot be restored to the original color even if they are washed. When performing the printing for the first time, do that after applying the agent to an unnoticeable area on trial.
- If you are using an electric spray to apply the pretreatment, perform the work at a place as far as possible from the printer. Otherwise, it may cause failure of print heads.

#### Reference guide for amount of coating of pretreatment

Determine a coating area and amount of coating according to a platen size. When your coating area differs from what are shown in the table below, calculate the amount of coating based on the area ratio.

#### <IMPORTANT>

- Depending on the type of fabric, the print quality cannot be guaranteed with the amount of coating of pretreatment shown below. It is therefore necessary to conduct sufficient print tests and adjust the amount of coating.
- If the amount of coating of pretreatment is too small, imprints of the pretreatment may become less noticeable after it is fixated, whereas color reproduction of the white ink and color inks on the white ink will deteriorate.
- Meanwhile, if the amount of coating of pretreatment is too large, imprints of the pretreatment may become noticeable, the printed surface may be cracked or discoloring may occur after washing.

Platen Size	Amount of coating of pretreatment
24 x 24	77 g (3 oz)
18 x 22	53 g (2 oz)
16 x 18	39 g (1 oz)
14 x 16	30 g (1 oz)
10 x 12	16 g (1 oz)
7 x 8	8 g (0.5 oz)
Letter size/A4-size	15 g (1 oz)
Pocket size (3.9 in. x 3.9 in. (10 cm x 10 cm))	3 g (0.5 oz)

**For coating with a pretreatment applicator (commercial product: preferably of an electrically-operated type)**

- (1) Fill the pretreatment applicator with the diluted pretreatment.

<TIPS>

- Please use a pretreatment applicator (preferably of an electrically-operated type) that can emit fine spray.

- (2) Set the T-shirt on the pretreatment applicator, and apply the pretreatment evenly onto the print surface.

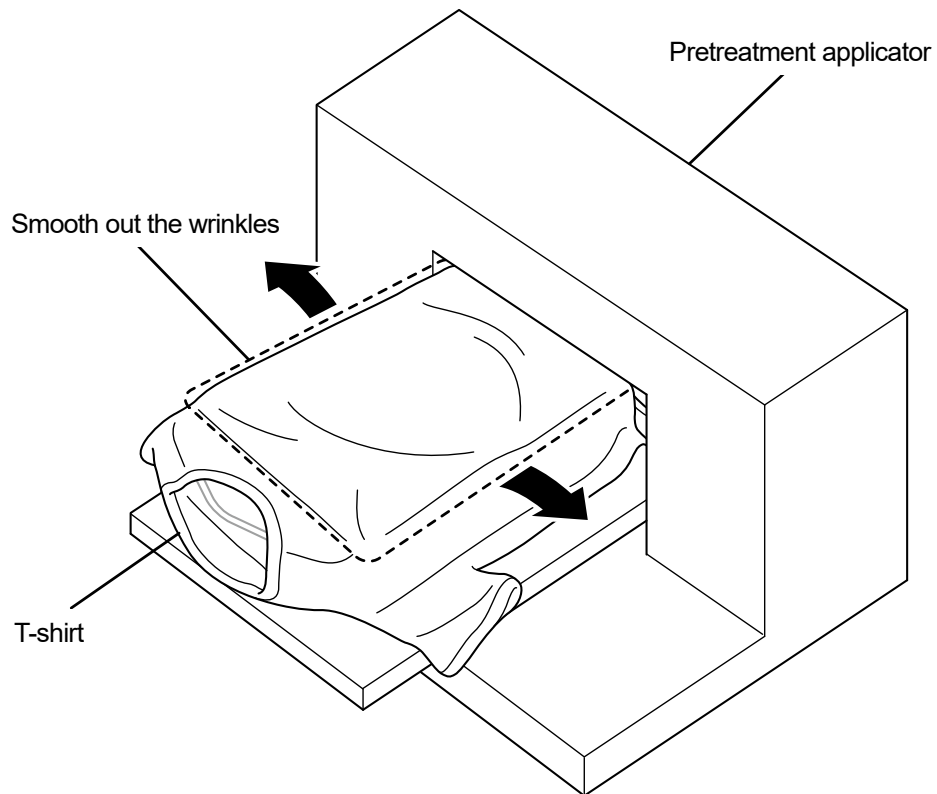

X1039

## For coating with a spray (commercial product: preferably of an electrically-operated type)

- (1) Fill the spray with the diluted pretreatment.

### <TIPS>

- Please use a spray (preferably of an electrically-operated type) that can emit fine spray.

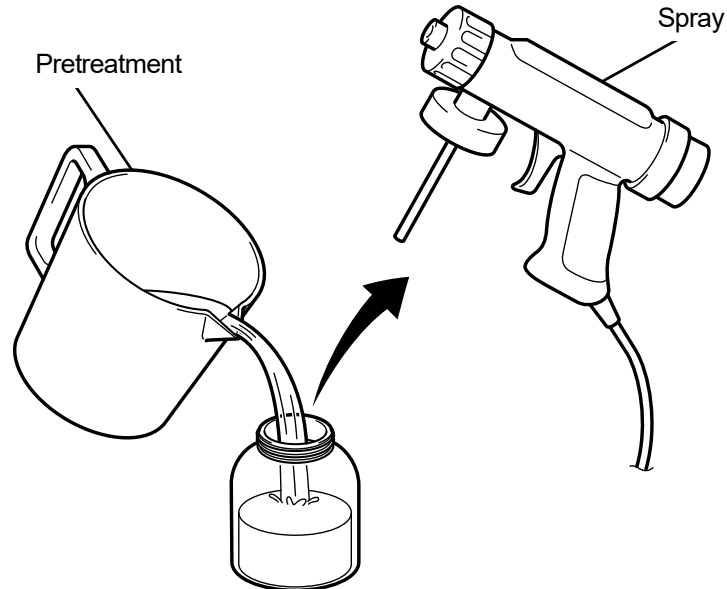

X0083

- (2) Put a T-shirt flatly on a flat surface or lean it back against wall, and apply the pretreatment evenly onto it with a spray.

### <CAUTION>

- Fully take care of the air ventilation when you are in operation that generates mist, such as spray application.
- Be sure to wear a pair of plastic gloves, a mask and protective glasses (or goggles) designed to shield against liquid splash during the work operation.
- For information on handling of the pretreatment, see the Material Safety Data Sheet issued by us.  
<http://sds.brother.co.jp/sdsapp/index.html>

### <IMPORTANT>

- If you are using an electric spray to apply the pretreatment, perform the work at a place as far as possible from the printer. Otherwise, it may cause failure of print heads.

### <TIPS>

- Note that pretreatment will not soak into the back (reverse) side of a T-shirt if you put an intermediate plate in the T-shirt. Remove the intermediate plate from the T-shirt before the pressing stage.
- When you are still unaccustomed to the spray coating, perform it while measuring the amount of coating by means of a weighing instrument.

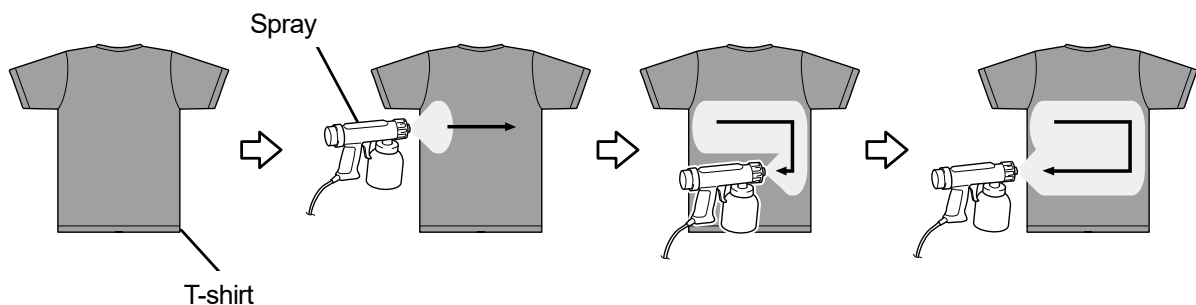

X0084

### 5-3-4. Fixation of pretreatment

#### <CAUTION>

- As the operation will generate mist, fully take care of the air ventilation.
- Be sure to wear a pair of plastic gloves, a mask and protective glasses (or goggles) designed to shield against liquid splash during the work operation.
- For information on handling of the pretreatment, see the Material Safety Data Sheet issued by us.  
<http://sds.brother.co.jp/sdsapp/index.html>

#### <TIPS>

- Because the pretreatment will not work best if it is dried through oven-based drying or air drying, be sure to use the heat press. As the oven does not bind fuzziness, the agent may be applied unevenly on white print.
- When you put a T-shirt on the heat press, set it so as to flatten the T-shirt's surface, place a peel-off sheet on the entire press area, and apply pressure.
- Note that any area in which the pretreatment is fixated may cause its effect to deteriorate or could cause the agent to be coated there unevenly if such area gets wet once.
- Do not touch the treated area with your hand after the pretreatment is fixated.
- After the pretreatment is fixated, do not touch or place the T-shirts on top of each other.
- Avoid leaving the pretreatment as it is in any highly humid areas.
- If the agent is left unchecked for a long time, use the heat press to apply pressure to a T-shirt immediately before the printing in order to dry it well.

#### Guidelines on fixation conditions of pretreatment

The undermentioned fixation temperature/time serve as guidelines only, and optimum conditions vary with your heat press. Be sure to perform the fixation after checking on the temperature and fixation results beforehand.

#### <TIPS>

- Prior to and during a fixation process, check the heat press's temperature. If the fixation is performed continuously, the heat press's temperature will decrease, resulting in improper fixation of the pretreatment. In this case, the whiteness cannot be reproduced because the white ink soaks into the fabric of a T-shirt.
- Such a pressure is required that is adequate enough to flatten the surface. As the fixation conditions differ by heat press, check the ink fixation result in advance and adjust the pressure.
- If it is not dry enough after pressing for 35 seconds, extend the time while checking the dried condition of the pretreatment.
- The following values should be regarded as guidelines only, for the optimum fixation conditions depend on the amount of coating of pretreatment.

Temperature	Time
180°C (356°F)	35 seconds

- (1) Place the silicone foam, T-shirt and peel-off sheet in position under the heat press first, and fixate the pretreatment properly.

## &lt;TIPS&gt;

- Water droplets are generated around the heat press to evaporate water content of the pretreatment by the heat of heat press. Keep your working space clean so that the surface to be coated with the agent will not get wet.
- A peel-off sheet should be used if needed, depending on the heat press you use.

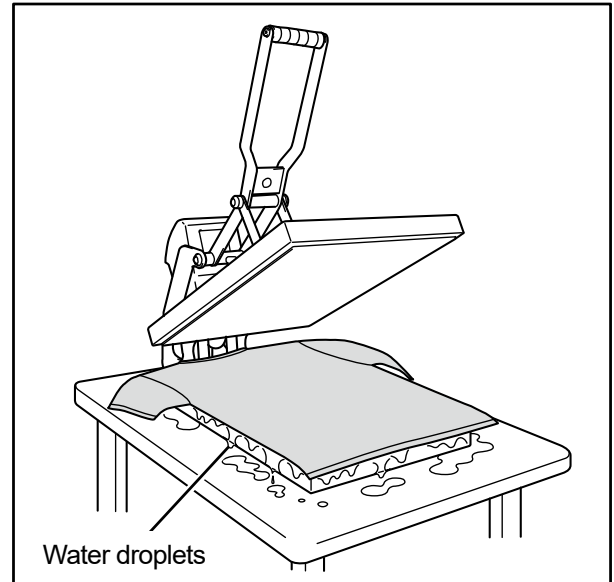
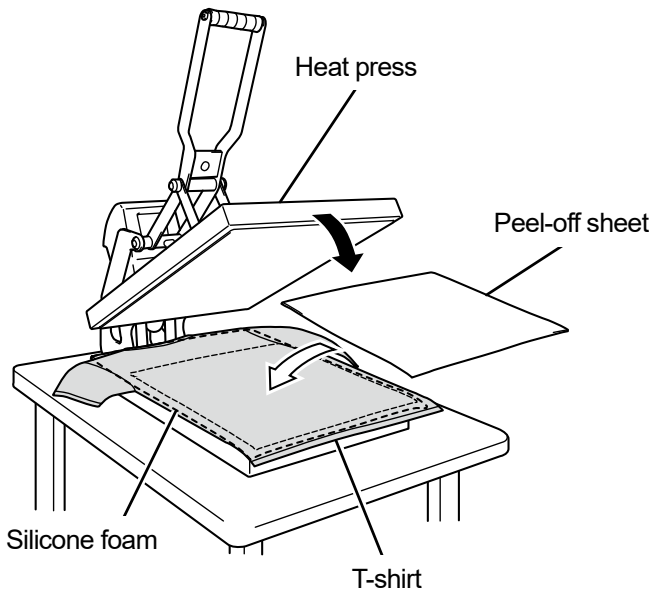

X0096

- (2) Remove the T-shirt from the heat press so that the steamy heat will escape from it.

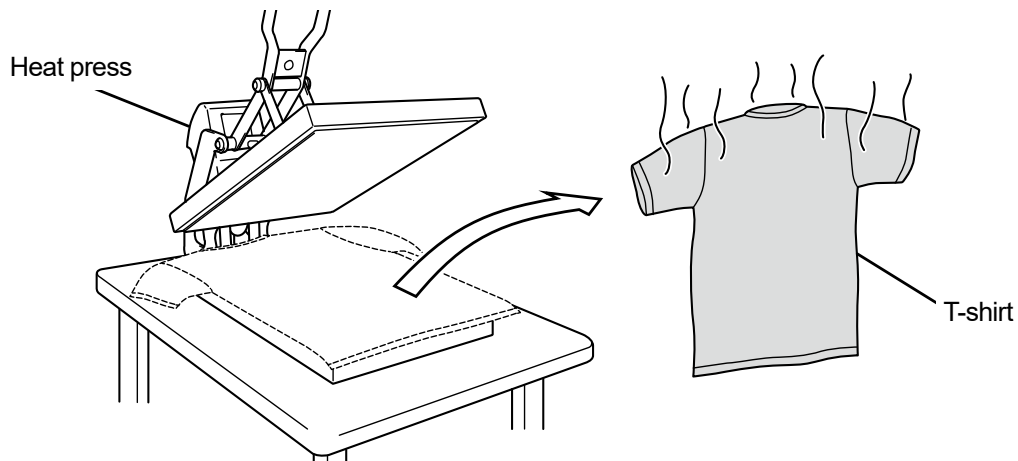

X0097

## 5-4. Platen adjustment

Replace the currently used platen with another one that suits the medium to be printed.

### <CAUTION>

- Hold the platen with both hands and be careful not to drop the platen at the time of platen replacement.

### <TIPS>

- In cases where such an optionally sized platen as 10X12 platen is used, ascertain that a proper "Platen size" has been selected in the printer driver's setting menu.
  - For print data using white ink, ☞"4-4-2. Select the platen size >>P.4-24"
  - For print data using color ink and black ink only, ☞"4-5-2. Select the platen size >>P.4-41"

### 5-4-1. Replacing the currently used platen with another one

- (1) On the operation panel, press , and move the platen toward the front of the printer.

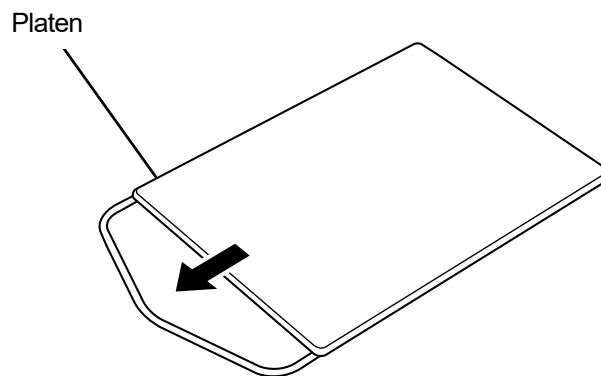

X1038

- (2) Loosen the platen fixing handle by rotating it one to three turns.

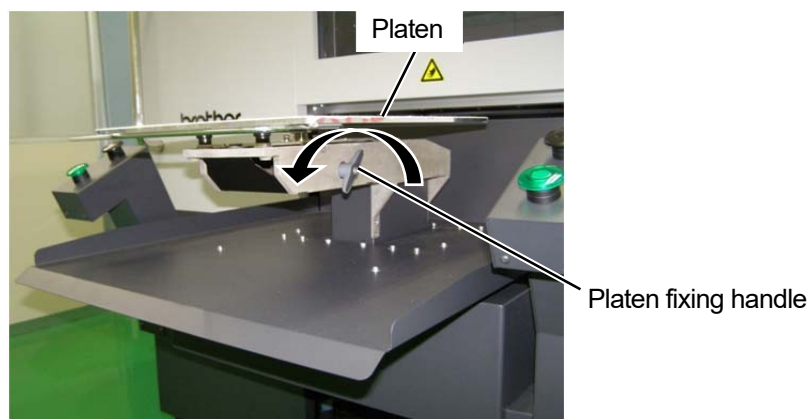

- (3) Remove the platen moving it straight upwards by holding both ends of it.

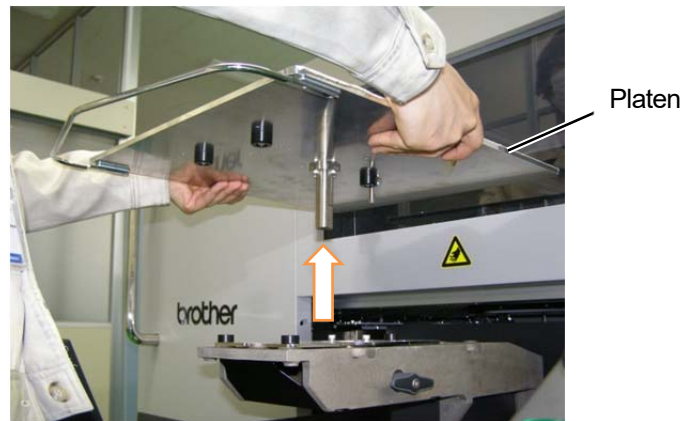

- (4) Put another platen to be used in position directly from above.



- (5) Tighten the platen fixing handle.

<TIPS>

- Place the platen fixing handle sideways so that the platen fixing handle will not come in contact when setting the platen or T-shirt.  
If the platen fixing handle is in portrait orientation, pull the platen fixing handle sideways and turn it in landscape orientation.

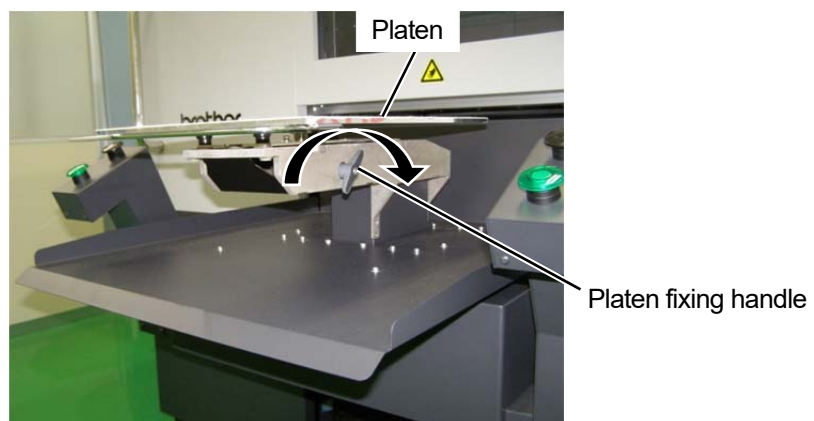



## 5-4-2. Platen height adjustment

Select a proper position of the platen corresponding to the print medium.

- (1) Select [Platen Height Adjustment] from the menu, and select an appropriate position from [Position A] to [Position H].

### <IMPORTANT>

- Do not handle the platen while printing. Injury may result if your hand gets caught between the platen or T-shirt tray and a door or cover.
- Be careful not to put your hands in the clearance of the cover of the lifting up/down mechanism. Doing so may cause injury. Otherwise, the operator may get injured.

### <TIPS>

- There are custom positions that can be set to any height.  
You can set the height from the menu by selecting [Printer Setting] > [Platen Setting] > [Height User Setting].  "7-9-1. User settings for height >>P.7-7"

### Printer Setting

Platen Height Adjustment  
Head Cleaning  
Test Print  
Ink Refill  
Print Data Load

### Platen Height Adjustment

Position A  
Position B  
Position C  
Position D  
Position E

### Platen Height Adjustment

Position F  
Position G  
Position H  
User setting 1  
User setting 2

## 5-5. Placing print medium in position

In order to provide an optimum printing image quality when a print medium is placed in position, you need to adjust the platen's height in accordance with the thickness of the T-shirt or other print medium.

### <CAUTION>

- Ensure there is adequate space left in front of the printer and avoid placing any objects. The platen moves forward while operating and it can strike/damage anything set in its path of movement.
- Do not handle the platen while printing. If your hand gets caught between the platen or the T-shirt tray and the covers, it may be injured.

### <IMPORTANT>

- Do not move the platen by hand. Otherwise the printer may be mechanically and electrically damaged.

### <TIPS>

- Adjust the height of the platen corresponding to the print medium before using it. As a rough indication, adjust the height so that it is lowered by one step from the limit height detected by the obstacle sensor, and check that the platen is not detected by the sensor.

In the event that the platen's height is lowered excessively, ink mist will be scattered inside the printer, which may result in staining of the printing surface, blurring of the printed image, and malfunction of the sensor and the main unit.

- Use Uni-Directional Printing in the case where the platen's height needs to be lowered to avoid a hemmed (edge) and seam.

☞"7-1. Setting the print direction >>P.7-3"

- (1) If the platen has not been moved forward, press  on the operation panel.

- (2) Adjust the platen's height.

### <TIPS>

- Set the platen height to [Position A] or in the neighborhood for a T-shirt, and to [Position C] or in the neighborhood for thick material, such as a sweatshirt.
- If the platen's height is lowered too much, the printing quality may deteriorate, the main unit may be soiled with ink mist and so on.

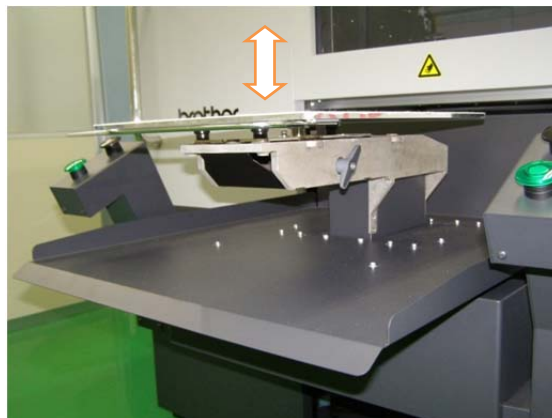

**(3)** Put a T-shirt onto the platen, with its printing side facing upward.

## &lt;TIPS&gt;

- For the position alignment of white or pale-colored T-shirts, a grid to be printed out on the platen sheet is available from [All Programs] in the Start menu, by selecting "Brother GTX-6 Tools" > "Useful Tools".  
☞"4-6-4. Print a grid pattern on the platen sheet >>P.4-51"

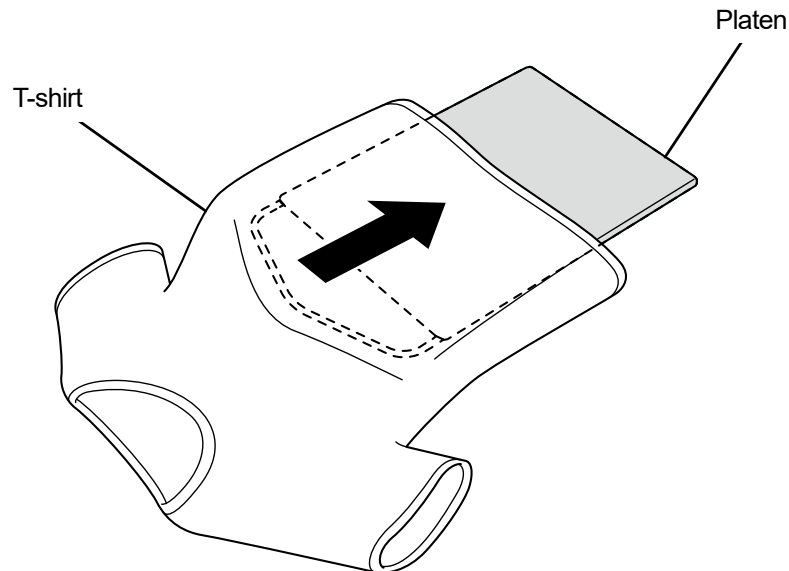

X1040

**(4)** Smooth down the creases in the T-shirt and remove lint and dust from it.

## &lt;TIPS&gt;

- Seams on a hemmed (edge), neck portion, armhole, tucks and sleeves or the like are easily detected by the obstacle sensor.
- In particular, both ends of the T-shirt tend to be raised easily during the printing operation if not flattened properly and detected by the obstacle sensor.
- Touching on the fixated pretreated surface should be avoided during the work.
- Do not pull the T-shirt with the pretreatment applied. Instead, flatten it in such a way that it will fit onto the platen surface well.
- When the surface of the T-shirt does not remain flattened properly, the obstacle sensor detects it.
- In the event that any T-shirt is placed on the platen by pulling it outward forcibly, there are instances in which ejection areas of the white and color inks are misaligned and the white ink extends off its specified printing area. In particular, be careful not to stretch a thin T-shirt outward on the platen.

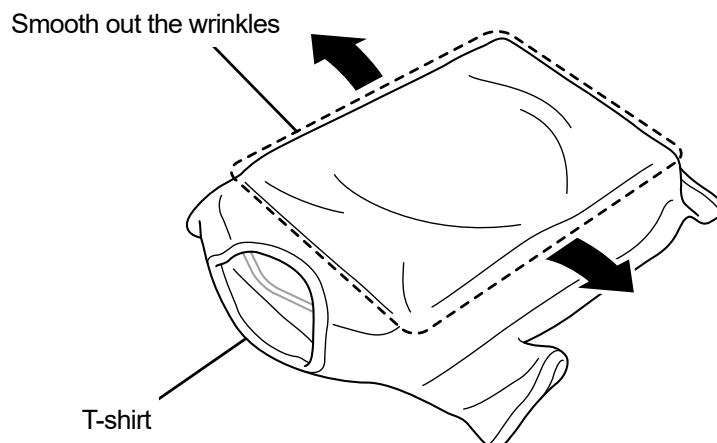

X1041

- (5) The T-shirt should be placed on the T-shirt tray, trying not to draw the excessive parts like sleeves and hems into the printer.

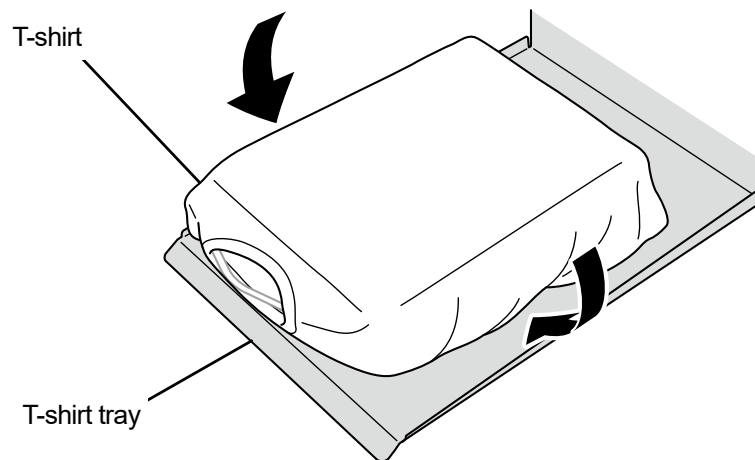

X1042

- (6) On the operation panel, press , and move the platen toward the rear of the printer.

Try moving the platen, and check on the gap between the T-shirt surface and the obstacle sensor over the entire print area.

<TIPS>

- If this gap is too wide, adjust the platen height.
- Adjust the height so that it is lowered by one step from the limit height detected by the obstacle sensor, and check that the platen is not detected by the sensor.
- If the platen's height is too high, a print medium will strike against the print head during the printing process, which in turn results in ink stains or malfunction.

- (7) On the operation panel, press , and move the platen toward the front of the printer.

<TIPS>

- Repeat the height adjustment until the platen will be positioned at a proper height.
- After your desired height is determined, start the printing operation.  "5-7. Executing a printing job >>P.5-29"

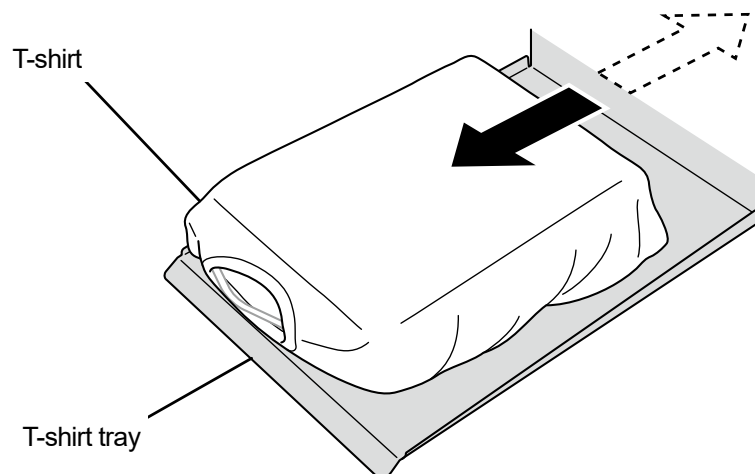

X1043

## 5-6. Sending/Loading Print Data

Print data can be loaded into the printer in the following ways:

- Receive the print data from the PC connected with the LAN cable.
- Load the print data from the USB flash memory.

For details, please refer to the chapters described later.

### 5-6-1. Sending print data from ARX6 file preview

- (1) Open an ARX6 file.

<TIPS>

- Double click on the ARX6 file, or select [All Programs] > "Brother GTX-6 Tools" > "GTX-6 File Viewer", to select and open the ARX6 file. You can also load ARXP and ARX4 files.

- (2) The file's printing conditions and preview window will be displayed.

<TIPS>

- If you have selected [Color+White Ink] or [White Ink Only] in the Select Ink operation, the preview window will be displayed against a "Black" background or a "Transparent color" background which has been specified in the Advanced settings.
- If you have selected [Color Ink Only] in the Select Ink operation, the preview window will be displayed against a "White" background.
- When you press the Details button, those items that have been specified in the Advanced setting window of the printer driver appear.

- When [Color+White Ink] or [White Ink Only] is selected

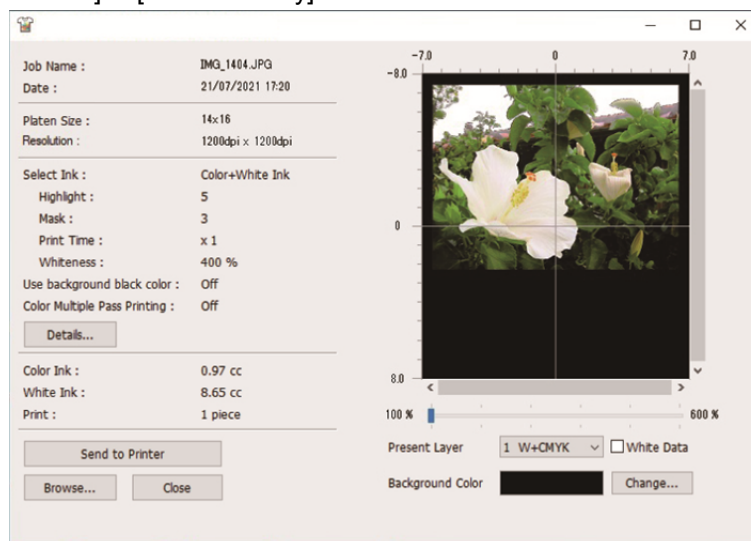

- When [Color Ink Only] is selected

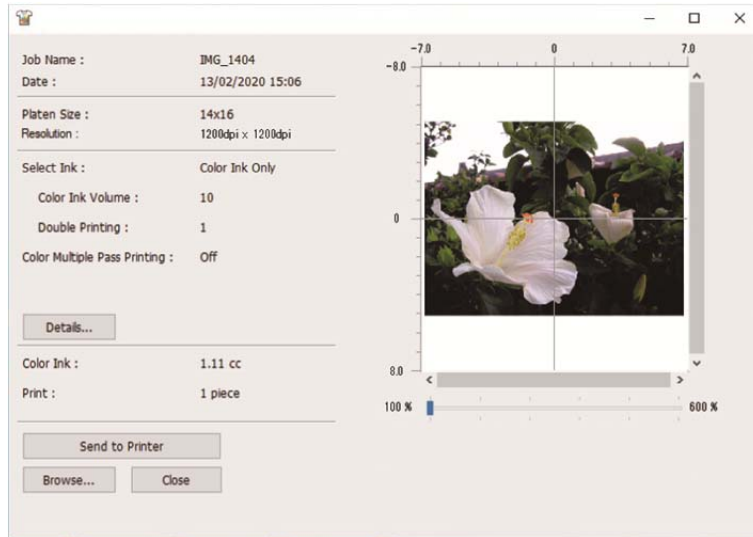

- [Details]

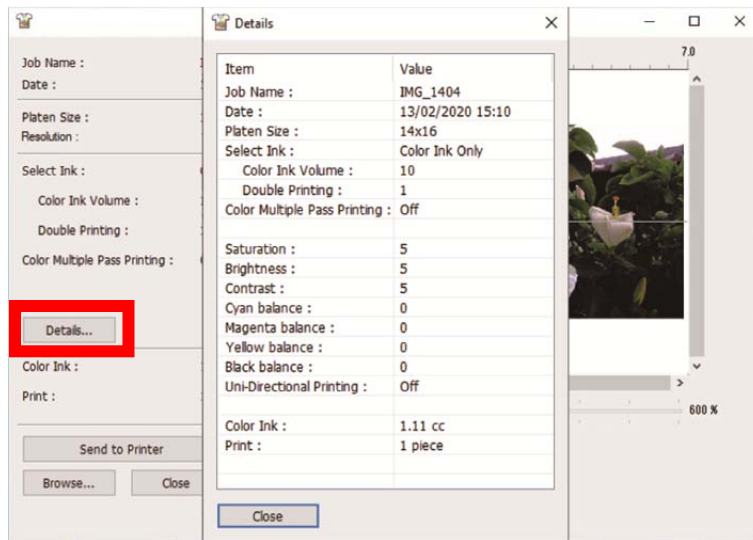

- (3) If you have selected [Color+White Ink] or [White Ink Only] in the Select Ink operation, you can change the background color of the preview window and preview the print image. Select [Change...] > [Define Custom Colors], and enter RGB value.

## &lt;TIPS&gt;

- When the [White Data] checkbox is marked, the preview window for white ink only will be displayed.

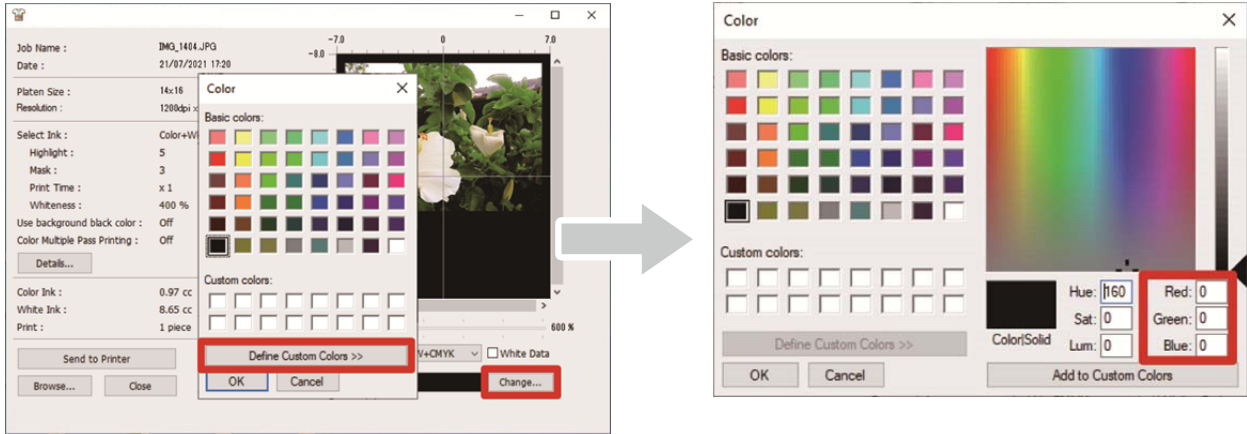

"Example: Preview window for printing an image on a brown (R=128, G=64, B=64) T-shirt"

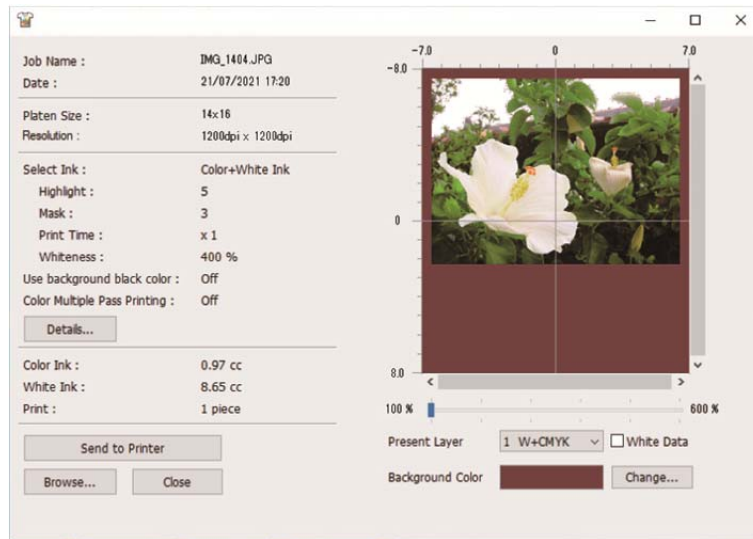

- (4) For the print data that requires multiple cycles of platen reciprocate movement, print data of each layer can be verified separately by selecting the desired layer to be displayed. From the [Present Layer], select a layer that you want to bring into the view.

## &lt;TIPS&gt;

- In the layer that is shown as [Total], the preview window of the final print result is displayed.
- When the [White Data] checkbox is marked, the preview window for white ink only will be displayed.

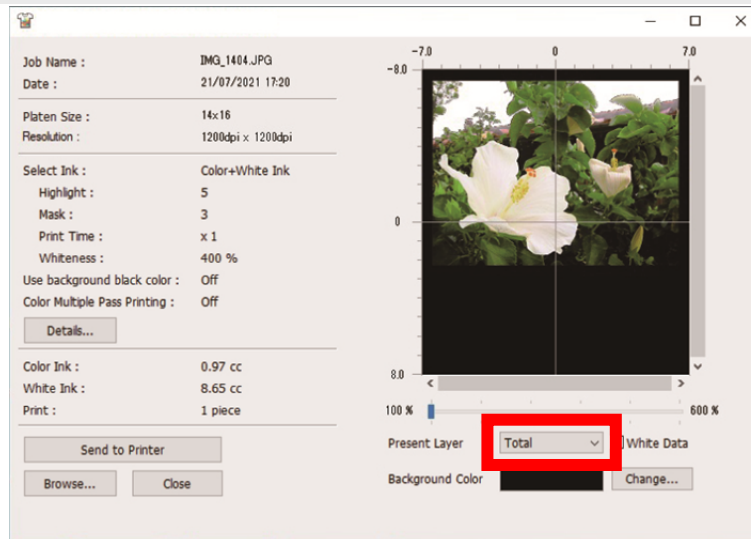

- (5) Check the printing conditions and preview window, and click on [Send to Printer]. Then, the ARX6 file is sent to the printer.

## &lt;TIPS&gt;

- Make sure that the PC and printer are connected via a LAN cable.
- In the event that two or more GTX-6 printer drivers have been installed on your PC, select one of them as the destination of data transmission and click [OK].

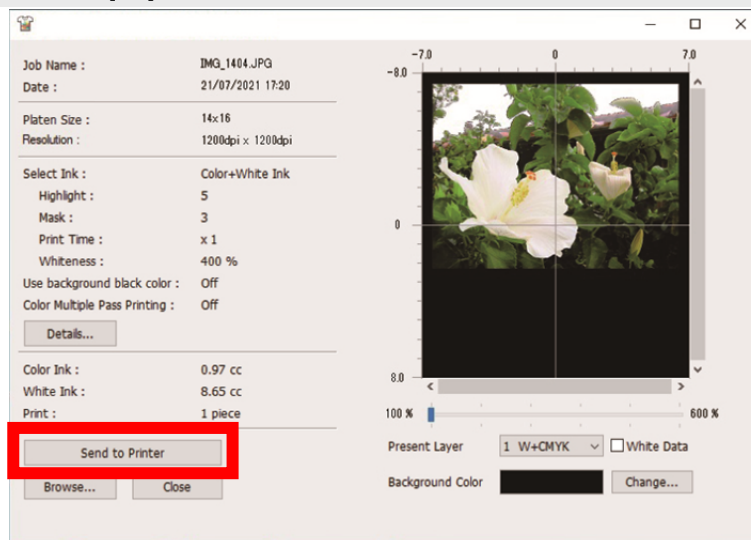



## 5-6-2. Sending print data from applications

### CoreIDRAW

- (1) In the menu bar, select [File] > [Print].
- (2) Open the [Color] tab, and make the following settings:
  - Place a checkmark in the [Document color] checkbox.
  - [Color conversions]: "Brother GTX-6" or "Brother GTX-6 FileOutput"
  - [Color Profile]: [sRGB IEC61966-2.1]
  - [Rendering intent]: [Relative colorimetric]

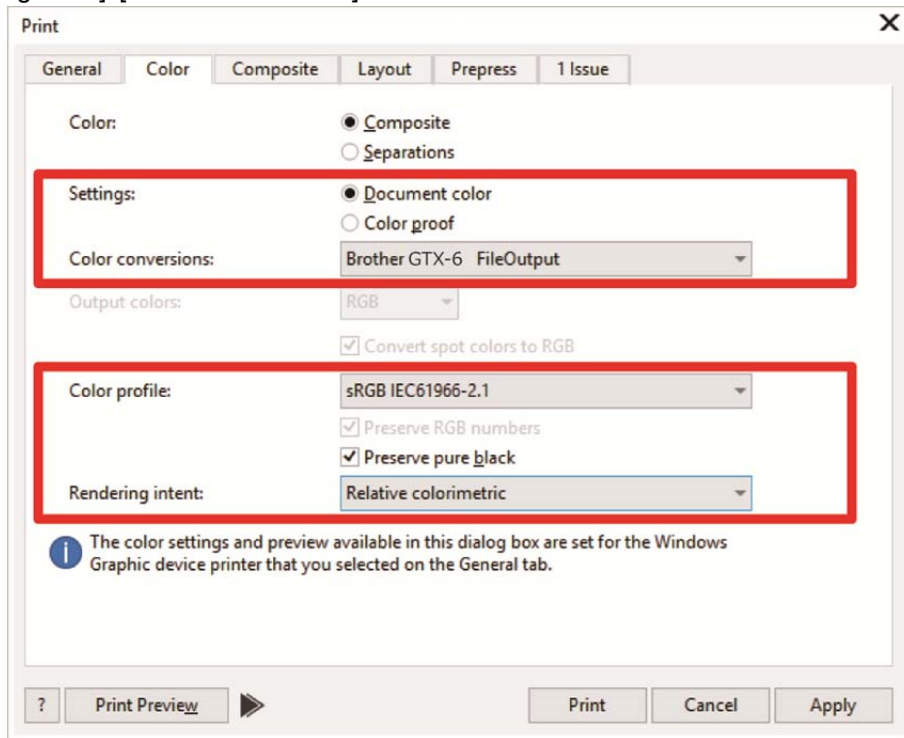

- (3) Open [General] tab and select "Brother GTX-6" from [Printer].

#### <TIPS>

- If the specified [Printer] is set to "Brother GTX-6", the print data will be sent to the printer.  
If the specified [Printer] is set to "Brother GTX-6 FileOutput", the print data will be saved as an ARX6 file.

- (4) On [Preferences], set up the printer driver and send the print data by clicking [OK] in the [Print] dialog box.

#### <TIPS>

- How to set the printer driver
  - For print data using white ink, [☞"4-4-1. Setting up the printer driver >> P.4-22"](#)
  - For print data using color ink and black ink only, [☞"4-5-1. Setting up the printer driver >> P.4-39"](#)
- Clicking on [OK] will not start the print operation of the printer itself. The print button of the printer should be pressed to start the printing operation.

## Adobe Photoshop

- (1) In the menu bar, select [File] > [Print]. If the PC's default printer is either "Brother GTX-6" or "Brother GTX-6 FileOutput", the layout is set to the platen size.
- (2) Make the settings as follows:
  - [Color Handling]: [Printer Manages Colors]
  - [Rendering Intent]: [Relative Colorimetric]

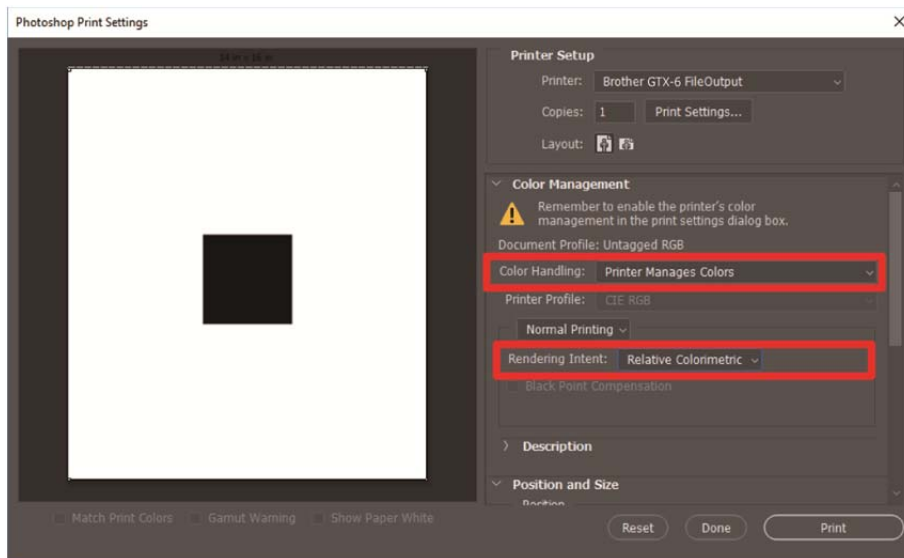

- (3) From [Printer], select "Brother GTX-6".

### <TIPS>

- If [Printer] is set to "Brother GTX-6", the print data will be sent to the printer.  
If [Printer] is set to "Brother GTX-6 FileOutput", the print data will be saved as an ARX6 file.

- (4) In the [Print Settings], set up the printer driver, and send the print data by clicking [Print].

### <TIPS>

- How to set the printer driver
  - For print data using white ink, see "4-4-1. Setting up the printer driver >> P.4-22"
  - For print data using color ink and black ink only, see "4-5-1. Setting up the printer driver >> P.4-39"
- Clicking on [Print] will not start the print operation of the printer itself. The print button of the printer should be pressed to start the printing operation.

## Adobe Illustrator

- (1) In the menu bar, select [File] > [Print] > [Color Management].
- (2) Make the settings as follows:
  - [Document Profile]: [sRGB IEC61966-2.1]
  - [Color Handling]: [Let Illustrator determine colors]
  - [Printer Profile]: [sRGB IEC61966-2.1]
  - [Rendering Intent]: [Relative Colorimetric]

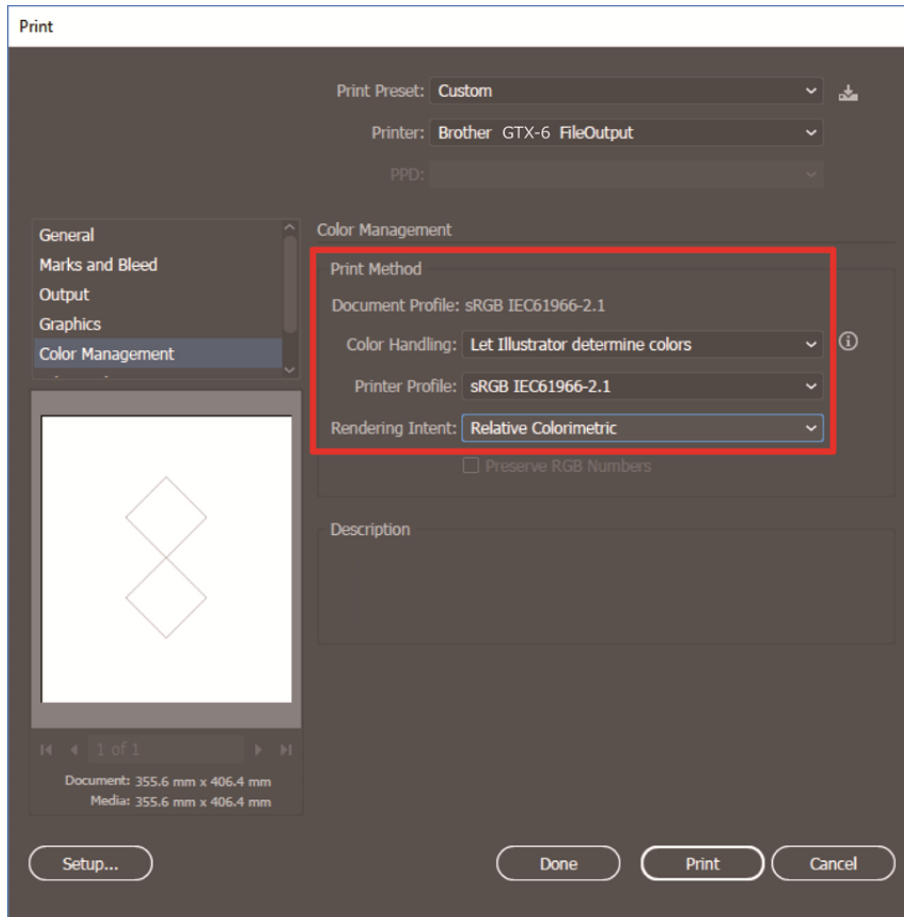

- (3) From [Printer], select "Brother GTX-6".

### <TIPS>

- If [Printer] is set to "Brother GTX-6", the print data will be sent to the printer.  
If [Printer] is set to "Brother GTX-6 FileOutput", the print data will be saved as an ARX6 file.

- (4) In the [Advanced], set up the printer driver, and send the print data by clicking [Print].

### <TIPS>

- How to set the printer driver
  - For print data using white ink, 4-4-1. Setting up the printer driver >> P.4-22"
  - For print data using color ink and black ink only, 4-5-1. Setting up the printer driver >> P.4-39"
- Clicking on [Print] will not start the print operation of the printer itself. The print button of the printer should be pressed to start the printing operation.

### 5-6-3. Loading print data (ARX6 file) from USB flash memory

- (1) Insert a USB flash memory into the insertion slot in front of the operation panel of the printer.

<IMPORTANT>

- Do not apply undue force to the USB flash memory when you insert it into the slot. Otherwise, it could be damaged.

<TIPS>

- Please use a FAT32-formatted USB flash memory of which storage capacity is 2 GB to 32 GB in total. You cannot use a USB flash memory with security functions such as password lock function or beyond 32 GB.
- Note that the data which can be loaded from the USB flash memory is only the data in ARX6, ARXP, or ARX4 format.





USB flash memory  
insertion slot

- (2) From the menu, select [Print Data Load], and press .

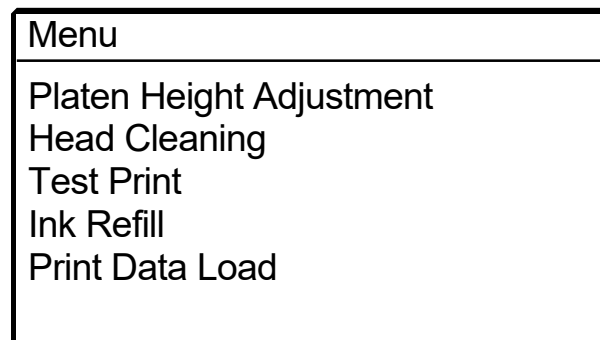

<TIPS>

- The information on file is shown on the liquid crystal panel.



- (3) Select a filename to be printed out, and press .

<TIPS>

- Selecting  will display the file stored in .
- Folders in the USB flash memory are shown down to the 3rd layer. Folders created in the 4th layer or below are not displayed.

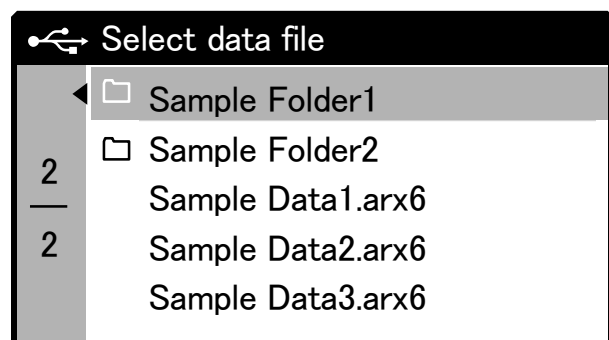
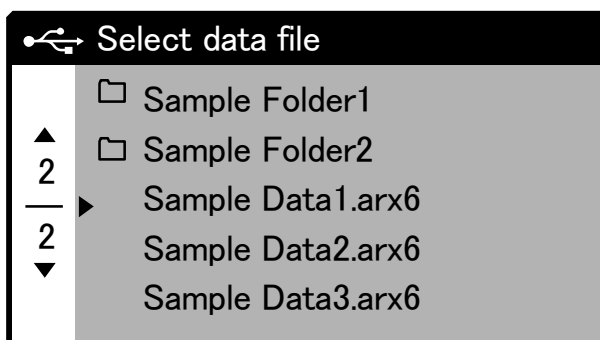

- (4) Check the print image displayed in the preview window, and press .

<IMPORTANT>

- Never touch the USB flash memory when the print button is blinking. Otherwise, any already-saved data may be corrupted.

<TIPS>

- Depending on data size, it may take several minutes before the loading process is completed.
- If any files of USB flash memory cannot be read out. [☞"8-1. Troubleshooting instructions">> P.8-2"](#)
- If a folder contains more than one print data item, use the ▲ / ▼ buttons to switch the preview window.

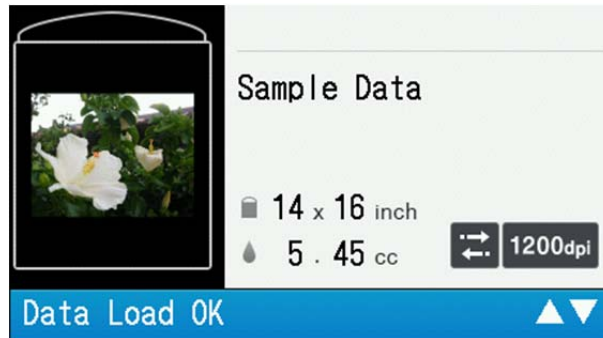

The print data loading will be completed when the print button stops blinking and remains lit, while the electric chime sounds.

## 5-7. Executing a printing job

### 5-7-1. Executing a print job once for a single print medium

(1) Receiving a print data file.

The print button blinks during reception of data. When the data reception is completed, an audible alarm is activated and the print button illuminates.

As there are two types of audible alarms, make sure the mounted platen matches the platen size of the print data.

<TIPS>

- When data of the same platen size as the previous one was received: A notice sound of "ping-pong" is output.
- When data of a different platen size from the previous one was received: A notice sound of "ping-pong pan-pong" is output.

(2) Make sure that the print data you want to print out is displayed on the liquid crystal panel, and press and hold the two print buttons at the same time to start printing. You will hear a sound each time you press the print buttons and after a certain period lapses.

When the printing is completed, the platen moves to the forward-most position and the sound of "pong" is heard.

<TIPS>

- If the print buttons are pressed when the platen has not moved toward the front, no print job will be started.
- Pressing  causes the printing to be canceled.
- The printer may shift to low temperature operation mode, when the room temperature is less than 18°C (64.4°F) and white ink is used.  
During low temperature mode, it may take a longer time for print operation and maintenance before starting the print. Change the low temperature operation setting as needed. ⌚"7-10. Print Operation Settings Under Low Temperature >>P.7-8"
- High-temperature and low-humidity environment may prolong the maintenance time after completion of printing. If any warning message about temperature and humidity is displayed, be sure to control the temperature and humidity promptly so as to conform with the print warranty scope. ⌚"10-1. Apparatus >>P.10-1"

## 5-7-2. Executing a print job several times for multiple print media

You can keep the identical print data and execute a print job several times for multiple print media.

### <TIPS>

- When the power is turned off, the retained print data is erased.

- (1) Make sure that the print data you want to print out is displayed on the liquid crystal panel, and press and hold the two print buttons at the same time to start printing. You will hear a sound each time you press the print buttons and after a certain period lapses.

When the printing is completed, the platen moves to the forward-most position and the sound of "pong" is heard.

### <TIPS>

- If the print buttons are pressed when the platen has not moved toward the front, no print job will be started.
- Pressing  causes the printing to be canceled.
- The number of print media of which printing is completed is shown on the liquid crystal panel.
- The printer may shift to low temperature operation mode, when the room temperature is less than 18°C (64.4°F) and white ink is used.  
During low temperature mode, it may take a longer time for print operation and maintenance before starting the print. Change the low temperature operation setting as needed. ⌘"7-10. Print Operation Settings Under Low Temperature >>P.7-8"
- High-temperature and low-humidity environment may prolong the maintenance time after completion of printing. If any warning message about temperature and humidity is displayed, be sure to control the temperature and humidity promptly so as to conform with the print warranty scope. ⌘"10-1. Apparatus >>P.10-1"

- (2) Replace the platen's printed medium (T-shirt) with the next one and repeat the procedure until the desired number of print jobs are completed.

### 5-7-3. Performing the printing from receiving history

You can print out such print data that you have received before.

<TIPS>

- The print data that can be retained are max. 100 pieces of them and 800 MB in total capacity, wherein each print data will be erased in the order from the oldest to the latest.
- When the power is turned off, the retained print data is erased.

- (1) From the menu, select a print data you want to print out in the [Receiving History].

<TIPS>

- Each of the pieces of print data is displayed in the order in which they are received from the newest to the oldest ones.

- (2) Make sure that the print data you want to print out is displayed on the liquid crystal panel, and press and hold the two print buttons at the same time to start printing. You will hear a sound each time you press the print buttons and after a certain period lapses.

When the printing is completed, the platen moves to the forward-most position and the sound of "pong" is heard.

<TIPS>

- If the print buttons are pressed when the platen has not moved toward the front, no print job will be started.
- Pressing  causes the printing to be canceled.
- The printer may shift to low temperature operation mode, when the room temperature is less than 18°C (64.4°F) and white ink is used.  
During low temperature mode, it may take a longer time for print operation and maintenance before starting the print. Change the low temperature operation setting as needed. [☞"7-10. Print Operation Settings Under Low Temperature >>P.7-8"](#)
- High-temperature and low-humidity environment may prolong the maintenance time after completion of printing. If any warning message about temperature and humidity is displayed, be sure to control the temperature and humidity promptly so as to conform with the print warranty scope. [☞"10-1. Apparatus >>P.10-1"](#)



## 5-8. Scheduling a print

Even if the printer is not in the standby state, this function allows you to schedule printing by pressing the Print button in advance so that the printer will start printing as soon as it becomes available.

### 5-8-1. When you can schedule printing

You can schedule printing by pressing the Print button in advance while the print data is being received, during the post-print processing, and during the circulation of white ink.

This is useful if the printer performs the post processing for the previous print job after you remove the printed T-shirt and set a new T-shirt to the platen.

#### <TIPS>

- Be sure to remove the printed T-shirt from the platen and set the next T-shirt to the platen before you press the Print button.
- You cannot press the Print button in advance if the printer is being operated from the menu or an error has occurred.

When you can schedule printing	Description
The printer is receiving print data	While the printer is receiving print data sent via the LAN cable
The printer is post-processing after a print	When a print job finishes and the platen is unloaded and while the printer is wiping, capping, cleaning the wiper, or performing an auto purge after a print job
During the white ink circulation	While the white ink is being circulated inside the printer at specified intervals or at a scheduled time for circulation

### 5-8-2. When a scheduled print begins

A scheduled print begins when each of the following conditions is true.

When you schedule printing	When the print begins
The printer is receiving print data	When the printer has completely received print data
The printer is post-processing after a print	When the printer has finished all the processes such as wiping, capping, cleaning the wiper, or an auto purge after a print job
During the white ink circulation	When the white ink circulation is completed

#### <TIPS>

- The Print button flashes fast during the period between when you schedule printing and when the printing begins.

### 5-8-3. When printing does not begin

A scheduled printing does not begin when each of the following conditions is true.

- If an error occurs when printing should begin. (For example, this is true if the ink is depleted in the previous print job.)
- If the data to print is missing from the printer when printing should begin.

### 5-8-4. Canceling scheduled printing

You can cancel scheduled printing by pressing the Cancel button during the period between when you schedule printing and when printing begins.

If you schedule a print during the white ink circulation and press the Cancel button, both the white ink circulation and the scheduled print are cancelled.

## 5-9. Removing printed matter from platen

- (1) Hold the shoulder portions of print medium with your hand, and pull it out slowly in the forward direction indicated.

<IMPORTANT>

- Because the printed surface is still wet with ink, avoid touching it.
- If any ink is attached to your hands, wash your hands with soap and water.
- Those inks that are attached to fabrics cannot be cleaned up, please handle the inks with utmost care.

<TIPS>

- The printed ink is not fixated at this point - therefore, handle the T-shirt with care to avoid the printed surface touching with other objects.

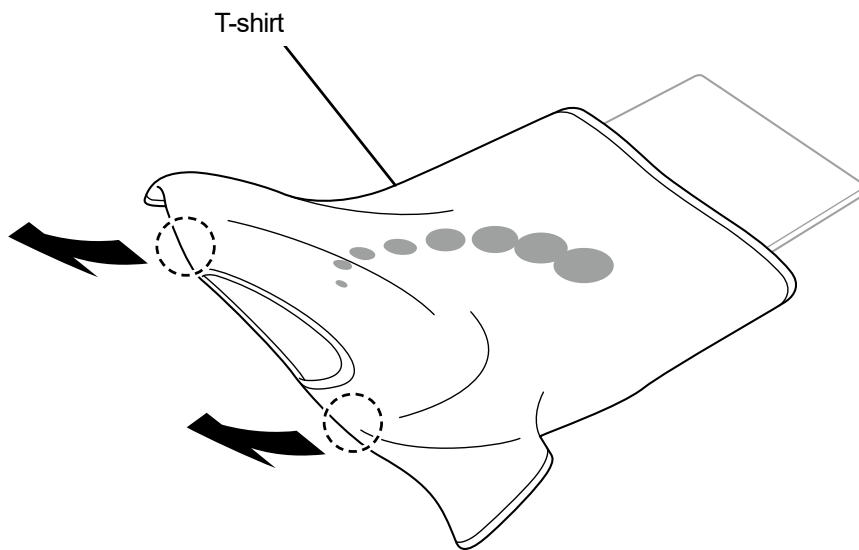

X1044

## 5-10. Fixation of ink

For fixation of ink, use the heat press or oven.

- Heat press
- It is useful because you can control its temperature and operating time with ease.
- Oven
- If the number of articles to be printed is high, it will improve the operational efficiency.

### <CAUTION>

- Please use the heat press and oven in a well-ventilated area. If your working area is not well ventilated, wear a protective mask.

### <TIPS>

- If the inks are fixated insufficiently, discoloring may occur due to washing and friction.
- Keep the fixation surface of heat press and peel-off sheet clean.  
Otherwise, the printing surface may be soiled with stains from the peel-off sheet.
- If a printed material is rubbed with vinyl-chloride-based white or light-colored synthetic leather, color transfer may occur.  
When a color-printed surface is rubbed strongly against a printed surface with only white ink, color transfer may occur in the same fashion.  
When a color transfer takes place, wipe the color-transferred area and clean off dirt with a soft and clean cloth or a toothbrush that is moistened with a small amount of mild detergent for home use and/or alcohol.
- Component of pretreatment remains on the T-shirt on which the ink was fixated after applying pretreatment. For this reason, it is advisable to wash such T-shirts with water before wearing them.

### Guidelines on fixation conditions of ink

The undermentioned fixation temperature/time serve as guidelines only, and optimum conditions vary with your heat press or oven. Be sure to perform the fixation after checking on the temperature and fixation results beforehand.

### <TIPS>

- Because optimum conditions vary depending on the type of your heat press or oven, use the fixation conditions as a reference guide. Be sure to adjust the conditions while checking on the temperature and ink fixation results beforehand.
- Because some print media easily get scorched, please carefully check and see how the surface actually looks like.  
In particular, the print media onto which the pretreatment has been applied will easily get scorched.
- When using the heat press, adjust the pressure while checking the ink fixation result.
- If it is not dry enough after processing for the period of the guideline, extend the time while checking the dried condition of the ink.

Device	Temperature	Time
Heat press	180°C (356°F)	35 seconds
Oven	Surface temperature: 160°C (320°F) <sup>*1</sup>	3 min. and 30 sec. to 5 min.

<sup>\*1</sup>: Because a T-shirt may be discolored if this temperature increases too high, great care should be taken to exercise temperature control.

## Ink fixation by means of heat press

- (1) Place the silicone foam, T-shirt and peel-off sheet in position under the heat press first, and fixate the ink properly.

### <TIPS>

- For the guidelines on fixation conditions of ink, refer to "5-10. Fixation of ink" on page P.5-34.
- For details, refer to the instruction manual of your heat press.
- There is a tendency to bring the print result to an almost matte finish if a silicone-coated paper is used as a peel-off sheet or to an almost bright finish if a fluororesin sheet is used as the same at the ink fixation stage. Selectively use either of them according to your desired finish.

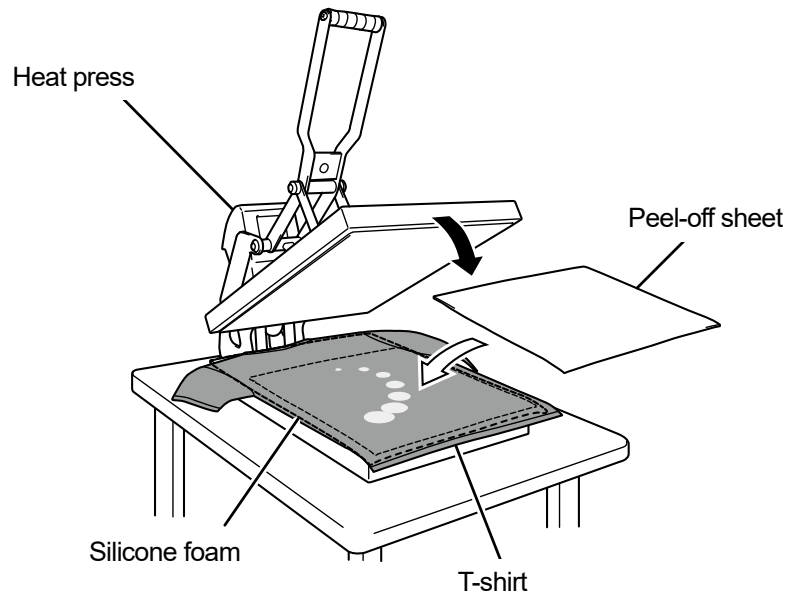

X0115

## Ink fixation by means of conveyor-type oven

- (2) Fixate inks onto a T-shirt by means of the conveyor-type oven.

### <TIPS>

- For the guidelines on fixation conditions of ink, refer to "5-10. Fixation of ink" on page P.5-34.
- For the conveyor-type oven, identify the oven's internal temperature, and check up on actual ink fixation result.
- For details, refer to the instruction manual of your conveyor-type oven.

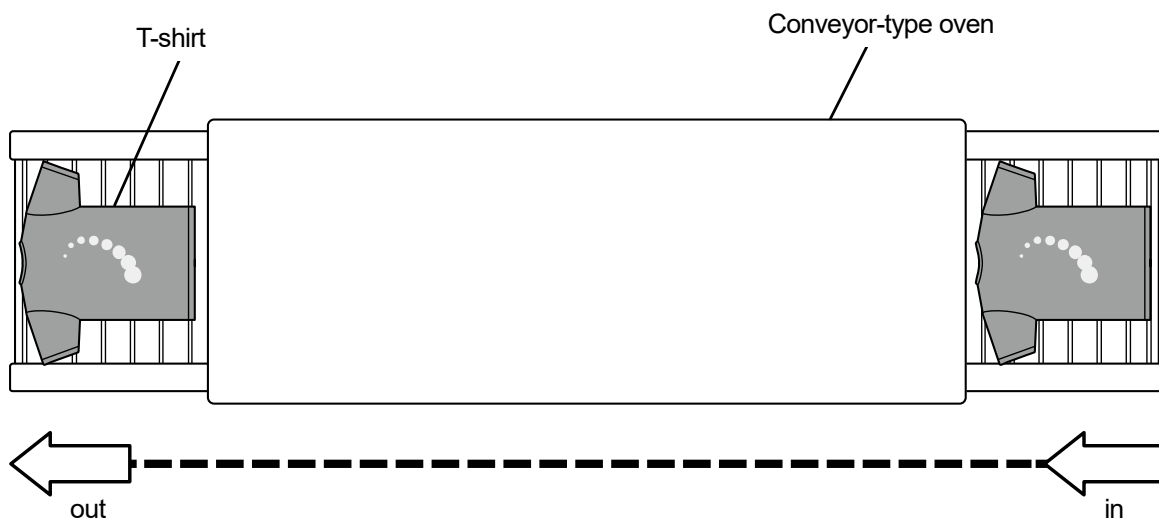

X0116

**⚠ DANGER**

Contact with high voltage sections may lead to a serious injury. Turn off the power, and remove the cover 5 minutes later.

**⚠ CAUTION**

Be careful not to pinch your fingers when closing each door and cover. You may get injured if you pinch your fingers.



Do not drink liquids such as the ink, maintenance solution, cleaning solution, pretreatment, or waste. They may cause diarrhea or vomiting.

When handling liquids, such as the ink, maintenance solution, cleaning solution, pretreatment, and waste ink, use protective glasses and gloves to avoid causing your eyes and skin to contact the liquids. It may cause inflammation. In case of contact with eyes, do not rub but immediately rinse the eyes with water.

Keep the liquids out of the reach of children.



Be sure to wear protective goggles and gloves when handling the grease, so that it does not get into your eyes or onto your skin.

It can cause inflammation.

Do not drink or eat the grease. It may cause diarrhea or vomiting.

Keep the liquids out of the reach of children.



When replacing parts and installing optional accessories, be sure to use only genuine Brother parts. Brother will not be held responsible for any accidents or problems resulting from the use of non-genuine parts.



When replacing parts or installing optional accessories, be sure to follow the procedures described in the Instruction Manual. Incorrect procedures could cause injuries or problems.

**((!))IMPORTANT**

Do not move the platen by hand. Otherwise the printer may be mechanically and electrically damaged.



Ensure there is adequate space left in front of the printer and avoid placing any objects. The platen may be hit and damaged.

## 6-1. Tasks to be performed regularly



### 6-1-1. Refilling color ink

If  is displayed in the remaining ink volume indication window on the operation panel screen, refill the ink.

#### <CAUTION>

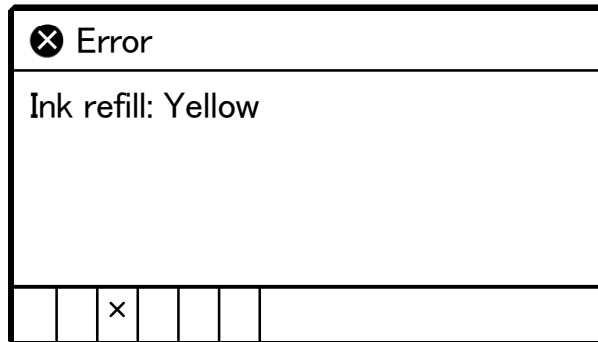
- Be sure to wear a pair of plastic gloves and protective glasses during the work operation.
- Take care not to lose the IC stick that comes standard with the ink bottle.
- Once you have refilled ink, you cannot print until you insert the IC stick.



- (1) From the menu, select [Ink refill] and press .
- (2) From [Black], [Yellow], [Cyan], and [Magenta], select the color with no ink and press .
- (3) Insert the IC stick of the same color as the refilled ink and press .

#### <TIPS>

- An error appears if you insert an IC stick of a different color from the depleted ink.



IC stick insertion slot

(4) Open the ink bottle and attach the supplied faucet.

<IMPORTANT>

- Protect the ink on the faucet in use with a plastic bag to prevent the ink from drying out.
- Do not use a non-standard funnel. Use the provided faucet. Otherwise, ink may be contaminated or deteriorated, possibly damaging the printer.

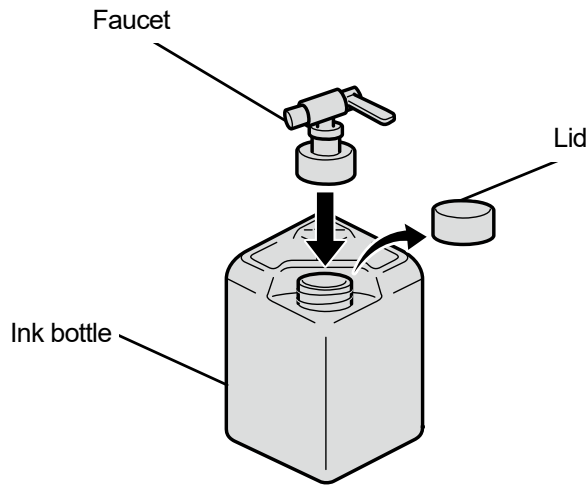

X1036

(5) Open the ink tank lid and refill ink up to above graduation mark 4.

<IMPORTANT>

- Take care not to exceed the graduation mark in 6.

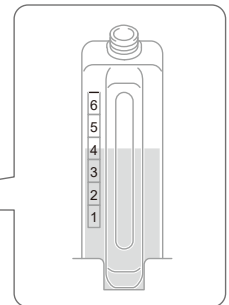

X1070

(6) Press **MENU OK** on the operation panel. Close the ink tank lid and press **MENU OK** again.

<IMPORTANT>

- Be sure to close the ink tank lid once you have refilled the ink.

(7) Remove the IC stick following the instructions on screen and press **MENU OK**.

<NOTE>

- Store the IC stick by attaching it to the handle of the ink bottle.
- Dispose of any waste resulting from the replacement in accordance with applicable laws and ordinances.

## 6-1-2. Refilling white ink

If  is displayed in the remaining ink volume indication window on the operation panel screen, refill the ink.

Agitate the white ink sufficiently to remove sediments before refilling it. Agitate the ink beforehand because it takes time.

### <IMPORTANT>

- Do not use ink not agitated sufficiently because doing so may deteriorate the durability of the printed matter or cause the head not to eject ink-jet droplets. In cases where the printer malfunctions due to the use of ink not agitated sufficiently, you may be liable for the cost of repairs even during the guarantee period.
- Agitate ink by shaking the ink bottle.
- Do not insert a bar or propeller into the ink bottle when agitating the ink because doing so causes foreign matter inclusion, possibly resulting in printer failure.

### <CAUTION>

- Be sure to wear a pair of plastic gloves and protective glasses during the work operation.
- Take care not to lose the IC stick that comes standard with the ink bottle.
- Once you have refilled ink, you cannot print until you insert the IC stick.

## Agitating white ink with an agitator

### <IMPORTANT>

- Be sure to install an agitator.  
To choose from many types of agitators available, consult your dealer.

### <TIPS>

- When agitating the white ink, remove the IC stick from the refill ink bottle to prevent it from falling off.

(1) Set the ink bottle to the agitator.

### <IMPORTANT>

- Securely fasten the ink bottle by means of a jig to prevent it from falling during agitation.

(2) Perform agitation with reference to the manual of your agitator.

### <TIPS>

- The recommended agitation time differs depending on the ink stationary period and agitator performance.



(3) Hold the ink bottle upside down and apply lighting to its side face to visually check sediments.

A dark shadow is seen on the bottom if sediments are remaining, so repeat steps (1) and (2) until such a dark shadow disappears.

<TIPS>

- Use bright lighting and darken the surrounding area to make the sediments more visible.

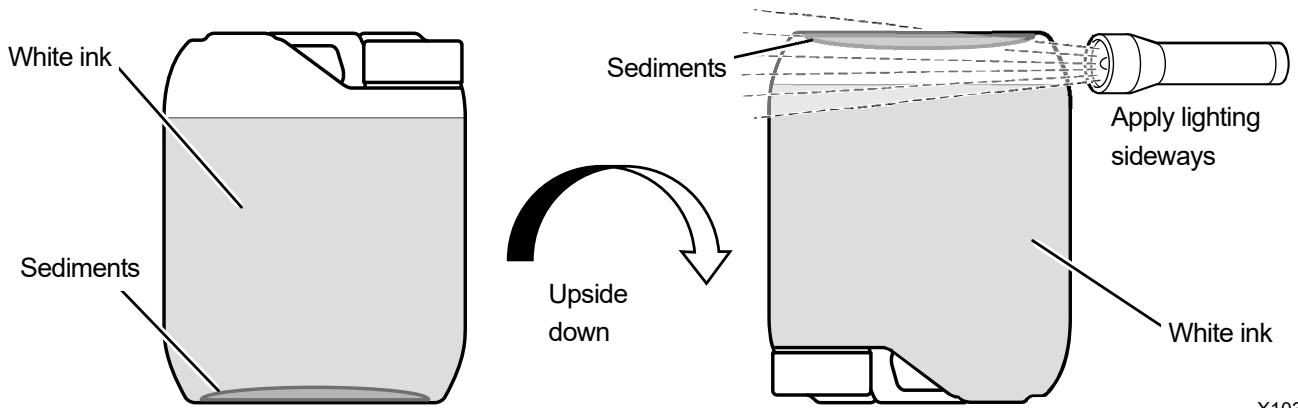

Agitated state

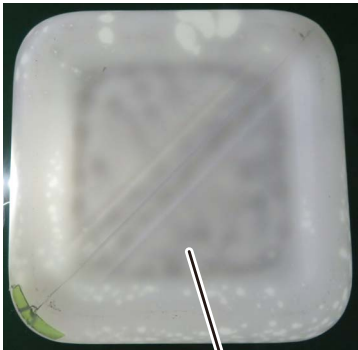
With sediments	Without sediments
 <p data-bbox="560 1402 683 1435">Sediments</p>	 <p data-bbox="1171 1402 1267 1435">Bubbles</p>

X1045

<TIPS>

- The shadows of bubbles may be confusing with sediments after the white ink agitation, so leave the bottle until bubbles disappear before checking for sediments.  
To distinguish between bubbles and sediments, lightly shake the ink bottle. The shadows of bubbles move, but the shadows of sediments do not move.

## How to refill white ink

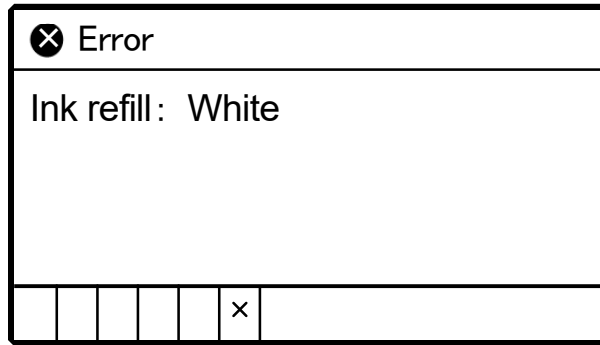

(1) From the menu, select [Ink refill] and press .

(2) Select [White] and press .

(3) Insert the white IC stick and press .

### <TIPS>

- An error appears if you insert an IC stick of a different color from the depleted ink.



IC stick insertion slot

(4) Open the ink bottle and attach the supplied faucet.

<IMPORTANT>

- Protect the ink on the faucet in use with a plastic bag to prevent the ink from drying out.
- Do not use a non-standard funnel. Use the provided faucet. Otherwise, ink may be contaminated or deteriorated, possibly damaging the printer.

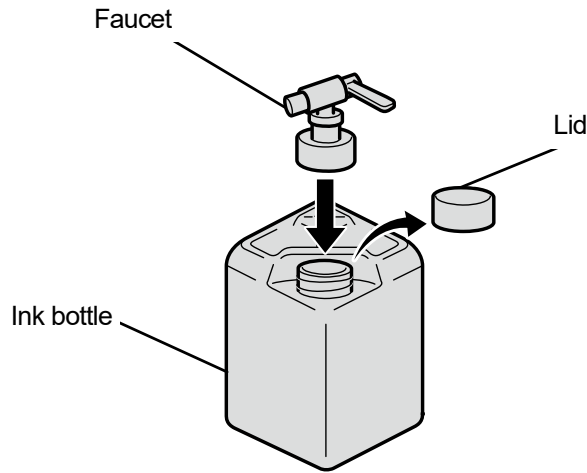

X1036

(5) Open the ink tank lid and refill ink up to above graduation mark 6.

<IMPORTANT>

- Take care not to exceed the graduation mark in 6.

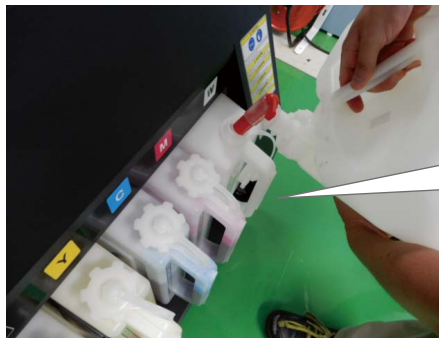

X1071

(6) Press **MENU OK** on the operation panel. Close the ink tank lid and press **MENU OK** again.

<IMPORTANT>

- Be sure to close the ink tank lid once you have refilled the ink.

(7) Remove the IC stick following the instructions on screen and press **MENU OK**.

<NOTE>

- Store the IC stick by attaching it to the handle of the ink bottle.
- Dispose of any waste resulting from the replacement in accordance with applicable laws and ordinances.

### 6-1-3. Refilling the cleaning solution

If  is displayed in the remaining ink volume indication window on the operation panel screen, refill the ink.



<CAUTION>

- Be sure to wear a pair of plastic gloves and protective glasses while working.

<TIPS>

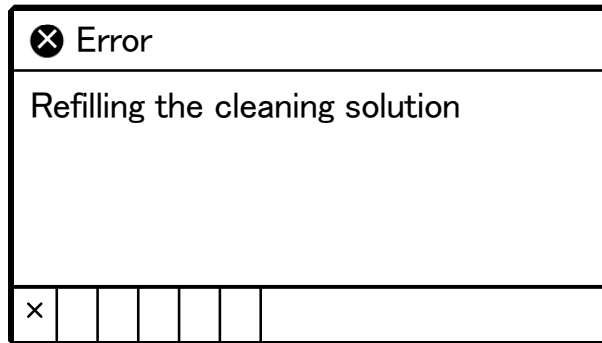
- Also check to see if the cleaning solution is kept at a proper liquid level in the cleaning solution tank and refill the tank with the solution if its amount is insufficient.



- (1) From the menu, select [Refill Ink] and press .
- (2) Select [Cleaning solution] and press .
- (3) Open the cleaning solution bottle and attach the supplied faucet.

<IMPORTANT>

- Protect the ink on the faucet in use with a plastic bag to prevent the ink from drying out.
- Do not use a non-standard funnel. Use the provided faucet. Otherwise, the cleaning solution may be contaminated or deteriorated, possibly damaging the printer.

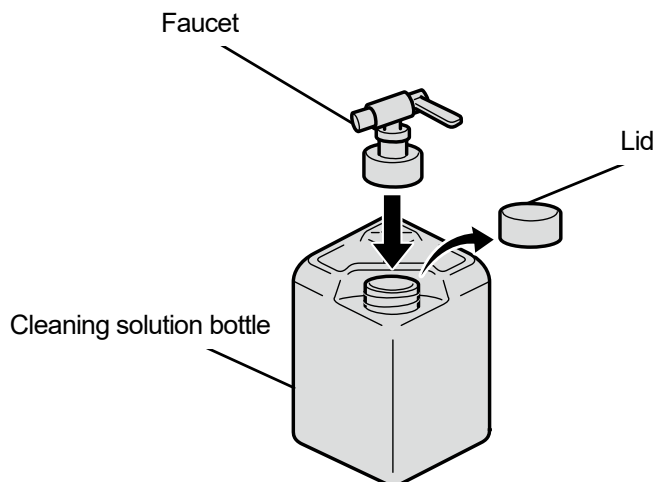

X1036



- (4) Open the cleaning solution tank lid and fill the tank with the cleaning solution up to above graduation mark 6.

<IMPORTANT>

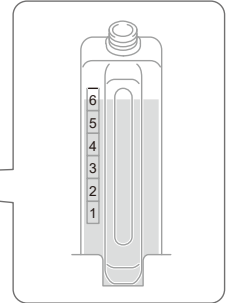
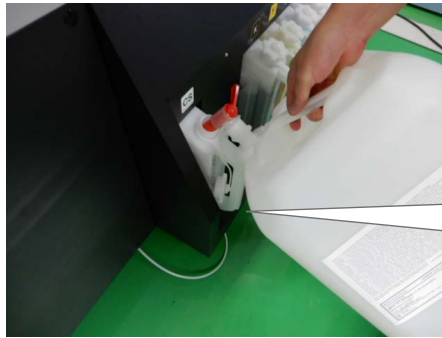
- Take care not to exceed graduation mark 6.



X1072

- (5) Press  on the operation panel. Close the cleaning solution tank lid and press  again.





<IMPORTANT>

- After filling the cleaning solution, be sure to close the cleaning solution tank lid.

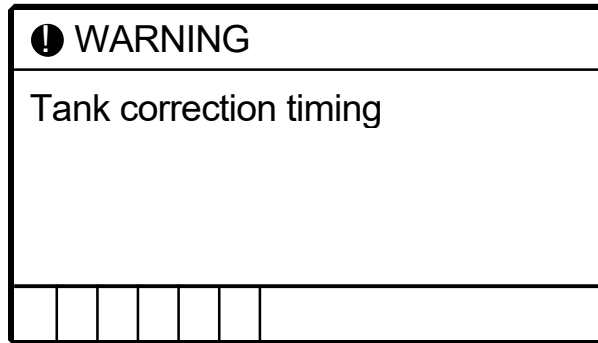
#### 6-1-4. Correcting the remaining ink level

When a warning message appears in the warning message window, correct the remaining ink level.



- (6) From the menu, select [Maintenance] > [Correct tank volume sensor], and press .
- (7) Press  / . Enter the scale for the ink level and press .

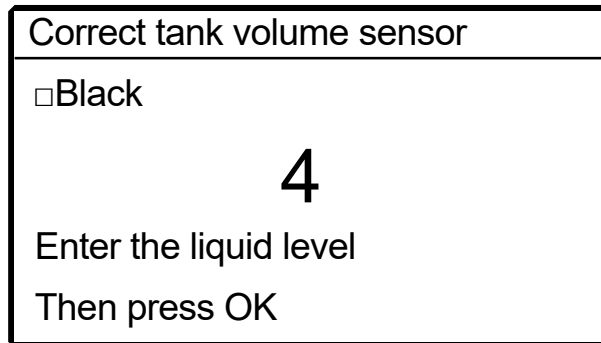

#### <TIPS>

- Check and correct the color scale displayed on the panel.
- If the level is between the scales, make a correction based on the lower value.

#### <CAUTION>

- If you enter an incorrect value, the remaining level may not be correctly recognized and the printer may be damaged.

### 6-1-5. Replacement of maintenance parts

When a warning message appears on the operation panel screen, replace each maintenance part.

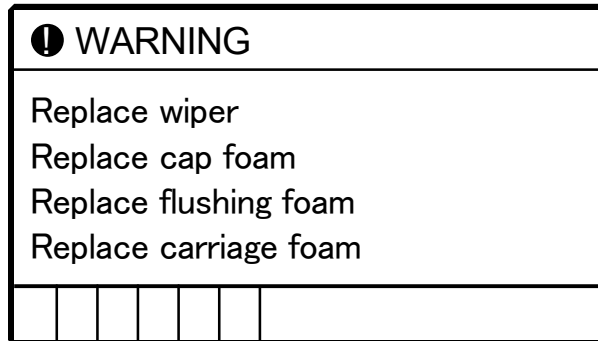

#### <TIPS>

- For the way to perform replacement, refer to the respective maintenance parts section.
  - ☞"6-1-6. Replacing the wiper >>P.6-12"
  - ☞"6-1-7. Replacing the cap chip and cap foam >>P.6-14"
  - ☞"6-1-8. Replacing the flushing foam >>P.6-17"
  - ☞"6-1-9. Replacing the carriage foam >>P.6-20"

## 6-1-6. Replacing the wiper

When a warning message appears on the operation panel screen, conduct replacement work.

<TIPS>

- Once you have selected [Maintenance Part Clean/Replace], you do not need to select it repeatedly in the case of replacing the wiper, flushing foam, cap tip, cap foam, and carriage foam in sequence.

(1) Have the supplied gloves and wiper ready.

(2) From the menu, select [Maintenance] > [Maintenance Part Clean/Replace] > [Maintenance Unit Part Replace], and press .

<IMPORTANT>

- If any other error or message is displayed on the operation panel or warning message window, follow the message to solve the problem, then perform the cleaning.
- Please complete the task within 15 minutes, in order to prevent the print heads from drying up.

<TIPS>

- Pressing  causes the platen to start moving. Do not put anything around the platen.

(3) Unlock the upper left-hand-side cover and top cover and open them.

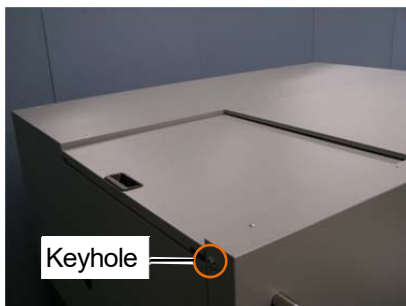



- (4) Remove the wiper from the maintenance unit by pushing up the latch on the left side of the wiper.

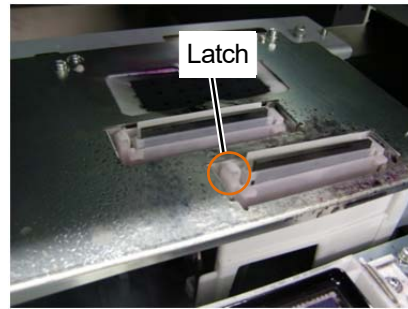
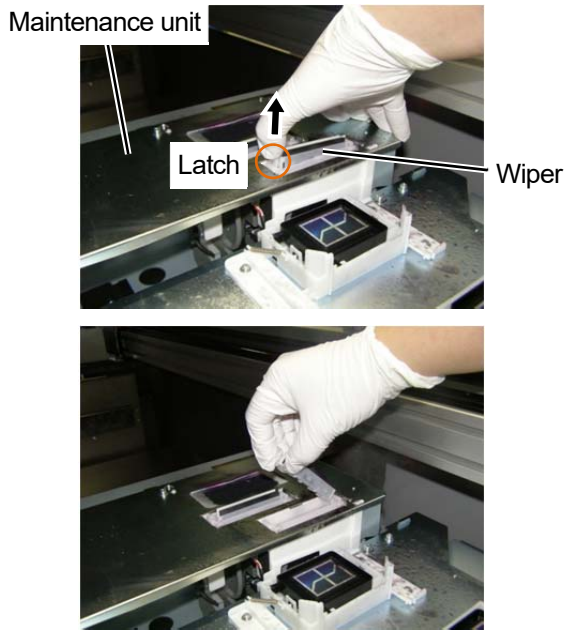

- (5) Hold the latch of the new wiper on the left-hand side and insert the new wiper into the maintenance unit from the right-hand side.

<IMPORTANT>

- Replace the wipers of the four locations at the same time.
- Make sure that each wiper is installed in the correct direction.
- Push the wiper in and make sure that the left and right protrusions are firmly fitted.

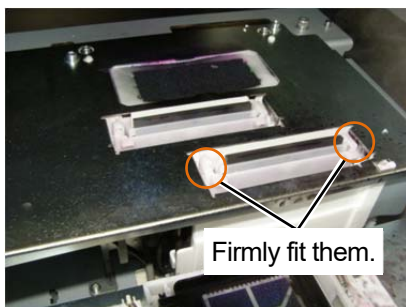
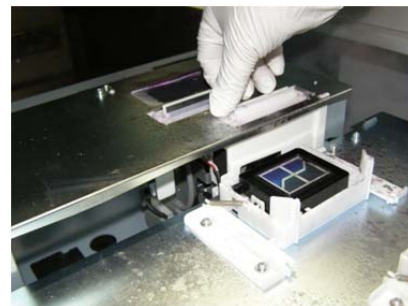
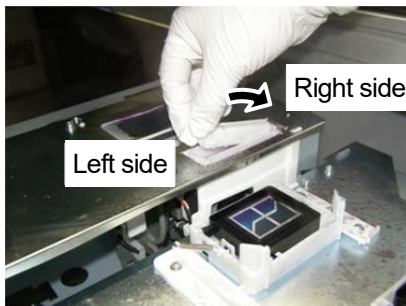

- (6) Close the upper left-hand-side cover and top cover.

<NOTE>

- Dispose of any waste resulting from the replacement in accordance with applicable laws and ordinances.
- Do not reuse the replaced wipers.

<TIPS>

- Then, the head cleaning will be performed to prevent any ink from drying up.

## 6-1-7. Replacing the cap chip and cap foam

When a warning message appears on the operation panel screen, conduct replacement work.

<TIPS>

- Once you have selected [Maintenance Part Clean/Replace], you do not need to select it repeatedly in the case of replacing the wiper, flushing foam, cap tip, cap foam, and carriage foam in sequence.
- When you replace the cap chip and cap foam, check the staining state inside the printer. If parts inside the printer are stained, perform cleaning. [☞"6-2-2. Cleaning and replacing maintenance parts >>P.6-56"](#)

(1) Prepare the gloves, cap chip, and cap foam.

(2) From the menu, select [Maintenance] > [Maintenance Part Clean/Replace] > [Maintenance Unit Part Replace], and press .

<IMPORTANT>

- If any other error or message is displayed on the operation panel or warning message window, follow the message to solve the problem, then perform the cleaning.
- Please complete the task within 15 minutes, in order to prevent the print heads from drying up.

<TIPS>

- Pressing  causes the platen to start moving. Do not put anything around the platen.

(3) Unlock the upper left-hand-side cover and top cover and open them.

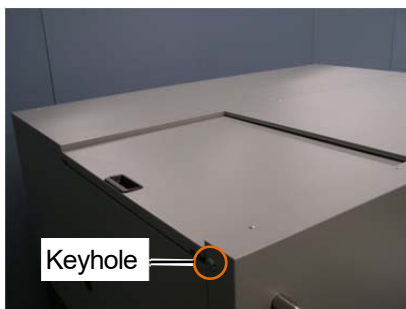

- (4) Remove the cap chip and cap foam from the maintenance unit.

<CAUTION>

- Do not use sharp objects, such as tweezers, and be sure to remove the cap chip and cap foam by hand.

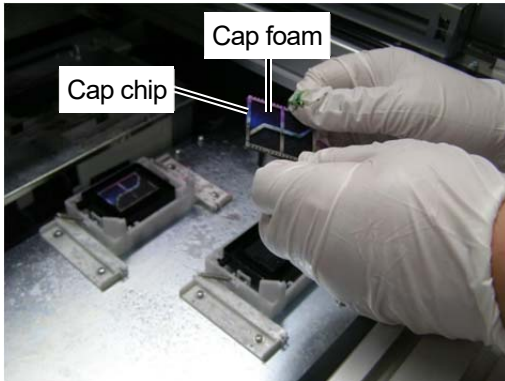

- (5) Wipe the gloves with a waste cloth.

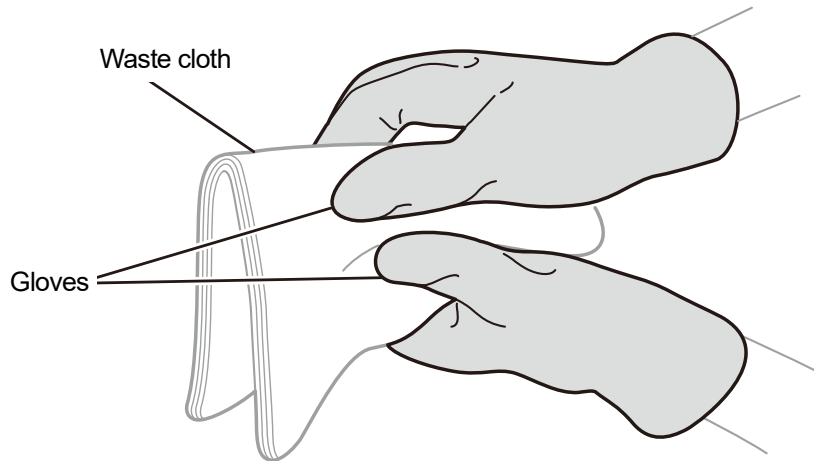

X0436

- (6) Set a new cap chip and cap foam.



<CAUTION>

- Set the cap foam by aligning the cap foam hole with the protrusion on the backside of the cap rubber.
- Be careful not to reverse the orientation of the cap foam.
- The cap chip has two sides. Be careful not to turn it upside down.
- Be careful not to turn the cap chip upside down when the cap chip and cap foam are assembled.

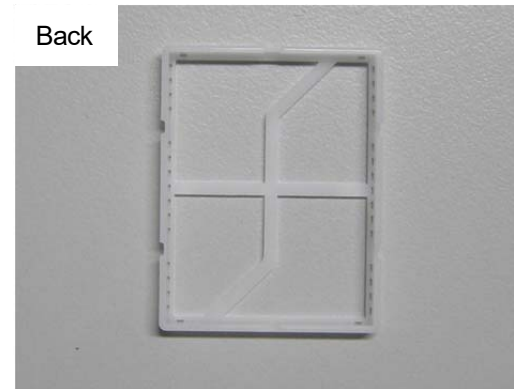
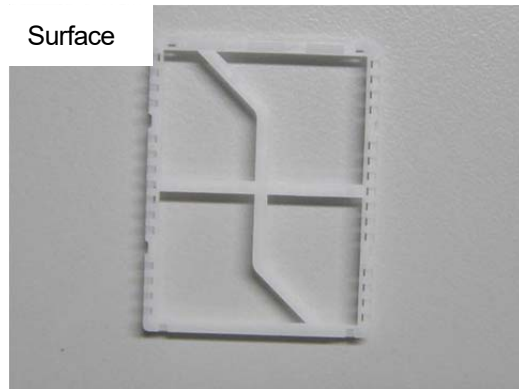
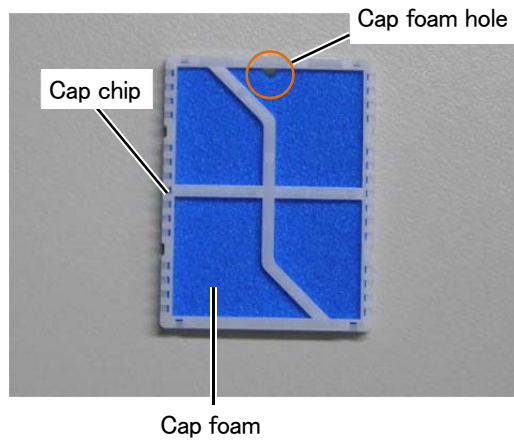
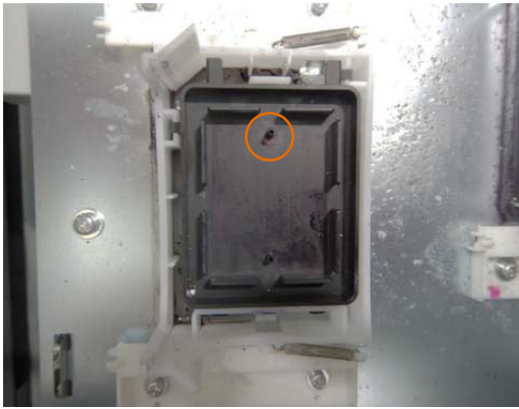

- (7) Close the upper left-hand-side cover and top cover.

<NOTE>

- Dispose of any waste resulting from the replacement in accordance with applicable laws and ordinances.

## 6-1-8. Replacing the flushing foam

When a warning message appears on the operation panel screen or in the warning message window, replace the specified flushing foam with a new one.

### <TIPS>

- Once you have selected [Maintenance Part Clean/Replace], you do not need to select it repeatedly in the case of replacing the wiper, flushing foam, cap tip, cap foam, and carriage foam in sequence.
- When you replace the flushing foam, check the staining state inside the printer. If parts inside the printer are stained, perform cleaning. ☞"6-2-2. Cleaning and replacing maintenance parts >>P.6-56"

(1) Prepare the gloves and flushing foam (consumable supplies).

(2) From the menu, select [Maintenance] > [Maintenance Part Clean/Replace] > [Maintenance Unit Part Replace], and press .

### <IMPORTANT>

- If any other error or message is displayed on the operation panel or warning message window, follow the message to solve the problem, then perform the cleaning.
- Please complete the task within 15 minutes, in order to prevent the print heads from drying up.
- Then, the head cleaning will be performed to prevent any ink from drying up.

### <TIPS>

- Pressing  causes the platen to start moving. Do not put anything around the platen.

(3) Unlock the upper left-hand-side cover and top cover and open them.

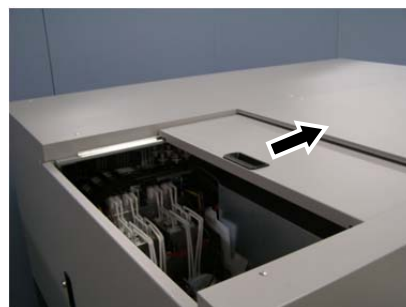
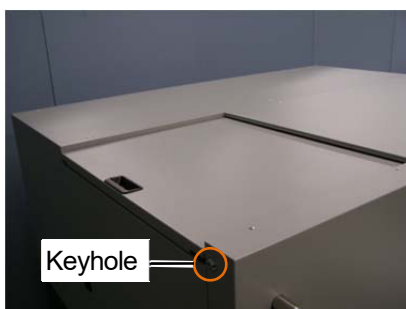

(4) Remove the flushing foam from the maintenance unit.

<IMPORTANT>

- Ink droplets will drop off from the hole in flushing foam. After removal, apply a waste cloth to the bottom face.

<NOTE>

- For a proper work operation, be sure to wear the printer-provided gloves.

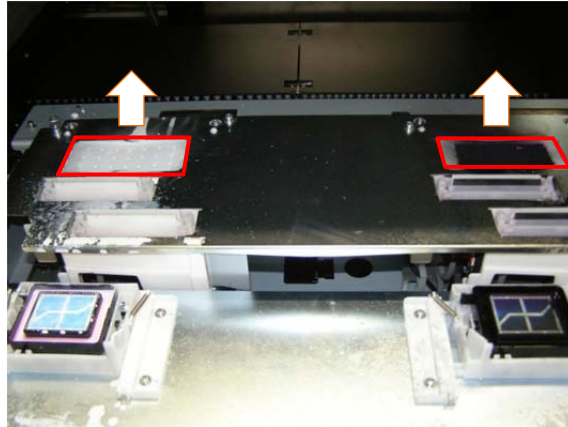

(5) Wipe the gloves with a waste cloth.

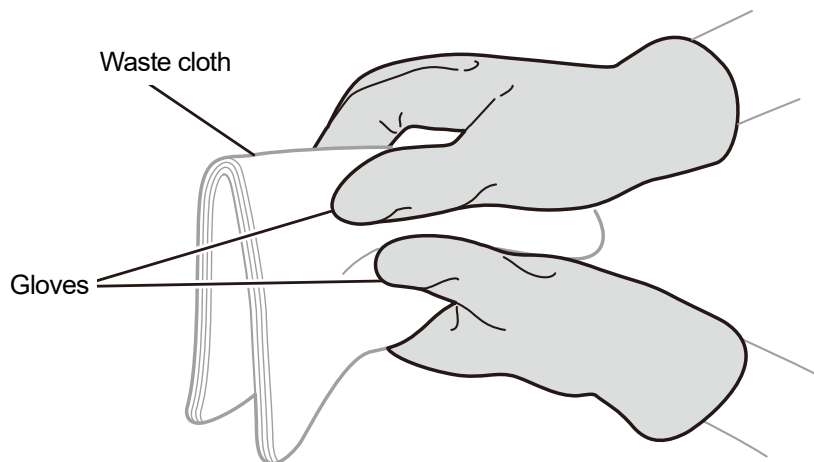

X0436



(6) Set the flushing foam in the maintenance unit.

<IMPORTANT>

- After this assembly process is completed, make sure that no flushing foam extends off the outboard end portions of the maintenance unit. If it sticks out of the end portions, it may interfere with any nozzles and may result in non-ejection of ink-jet droplets.

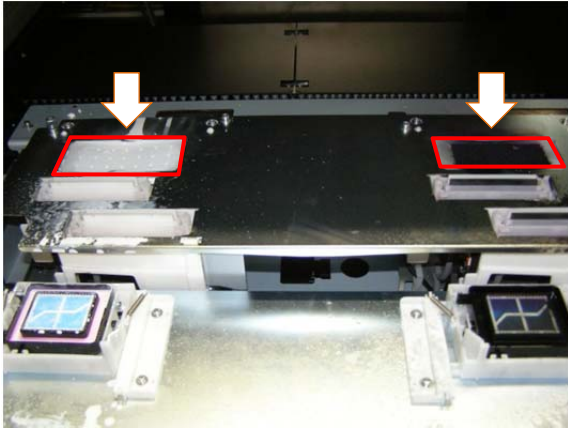

On the white side

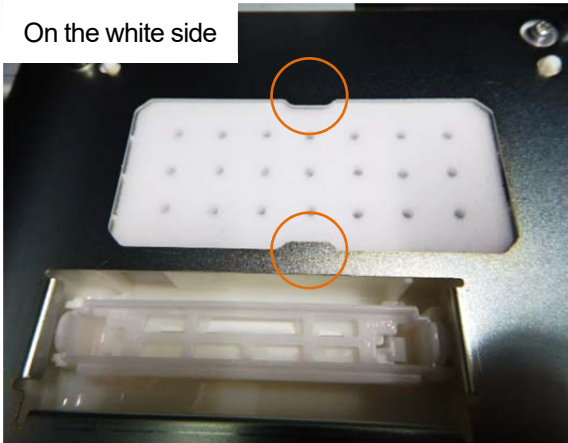

On the color side

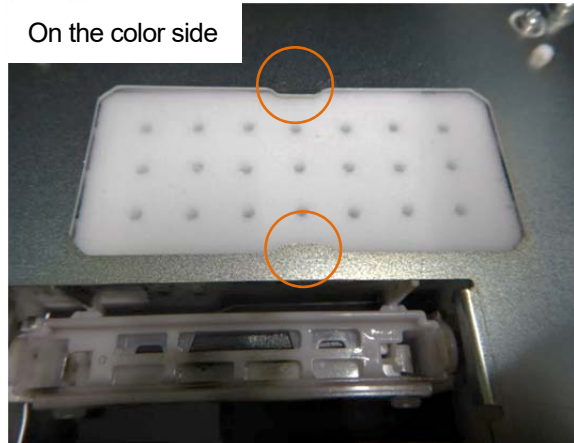

(7) Close the upper left-hand-side cover and top cover.

<NOTE>

- Dispose of any waste resulting from the replacement in accordance with applicable laws and ordinances.

<TIPS>



- The head cleaning will be performed to prevent ink from drying up.

## 6-1-9. Replacing the carriage foam

When a warning message appears in the warning message window, replace the specified carriage foam with a new one.

### <TIPS>

- Once you have selected [Maintenance Part Clean/Replace], you do not need to select it repeatedly in the case of replacing the wiper, flushing foam, and carriage foam in sequence.

- Prepare the gloves and carriage foam, which come standard with the printer.
- From the menu, select [Maintenance] > [Maintenance Part Clean/Replace] > [Maintenance Unit Part Replace], and press .
- Select [Replace carriage foam] and press .

### <IMPORTANT>

- If any other error or message is displayed on the operation panel or warning message window, follow the message to solve the problem, then replace the carriage foam.
- Please complete the task within 15 minutes, in order to prevent the print heads from drying up.
- There is a risk of damaging the nozzle surface of the head. Be careful not to damage the nozzle surface of the head.

- Unlock and open the right-hand-side cover.

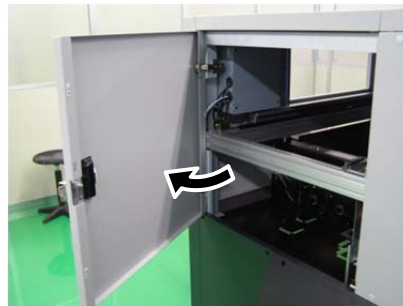

- Hold the end of the carriage foam and rotate the carriage foam downward to remove the carriage foam from the carriage magnet. Rotate the carriage foam until the carriage foam comes in contact with the sliding surface of the foam guide.

### <IMPORTANT>

- Be careful not to let the carriage foam come into contact with the nozzle surface of the head.
- Be careful when removing the carriage foam, which may come off suddenly.

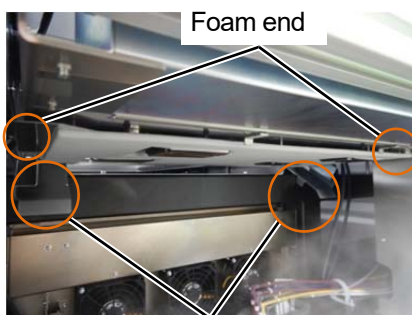

Sliding surface of foam guide





- (6) Pull and remove the carriage foam toward you along the sliding surface of the foam guide after making sure that the carriage foam is in contact with the surface of the foam guide.

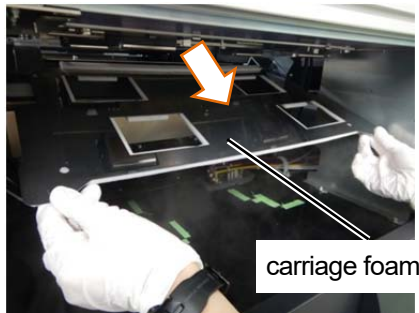

- (7) Put a proper amount of cleaning solution into the cleaning cup.  
(8) Moisten a new clean stick R with the cleaning solution.

<IMPORTANT>

- Use a new clean stick R when you start cleaning.
- Never touch the tip end of clean stick R with your hand. If any sebaceous matter is attached to the nozzle surface, it may malfunction the printer.
- Do not use other fluids (water, etc.), because they may damage the print heads.
- Do not return the cleaning solution which has been put in the cleaning cup to the cleaning solution bottle.
- Do not shed cleaning solution in the maintenance unit.

<NOTE>

- For a proper work operation, be sure to wear the printer-provided gloves.



X1000



(9) Clean the side of the print heads.

<TIPS>

- The use of a flashlight is recommended to make it easier to see when cleaning.
- It is not easy to see the rearward side of the nozzle guard. It is recommended to clean it while checking the cleaning condition with a mirror.

Nozzle guard side cleaning

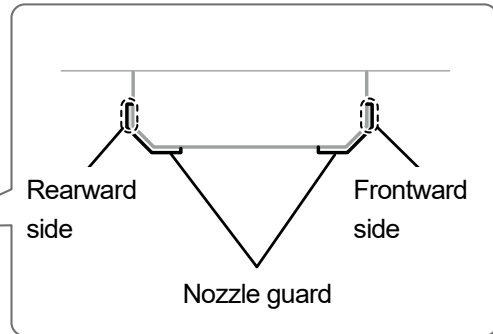
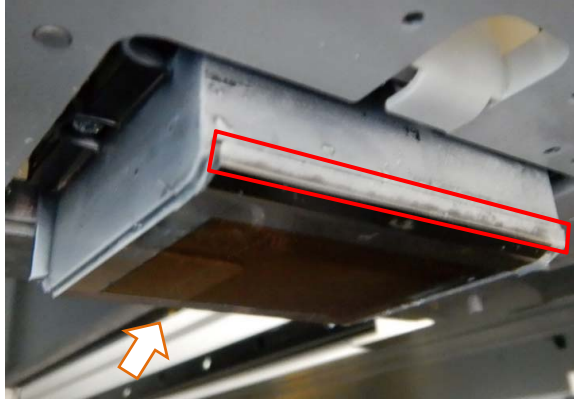

X1014

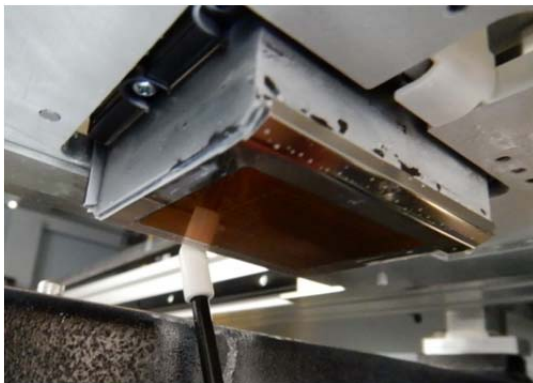

After nozzle guard side cleaning

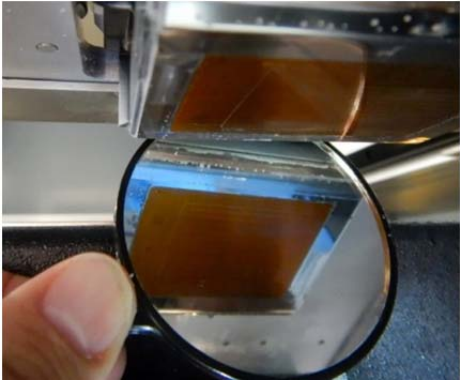
Head frontward side	Head rearward side
	

Head frontward and rearward cleaning

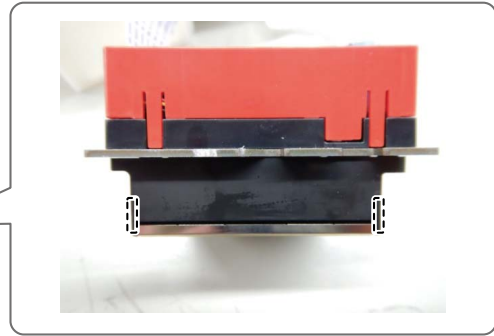
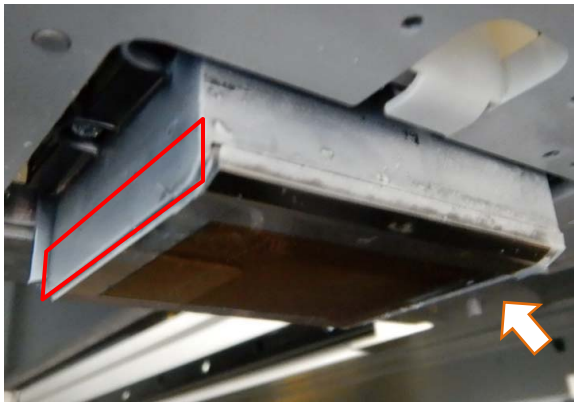

X1049



(10) Remove ink clots, if any, protruding from the nozzle surface on the underside of the carriage.

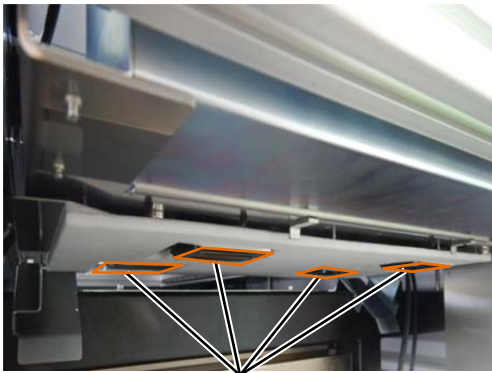

Nozzle surface

Ink clot example

<CAUTION>

- When removing ink clots, do not use hard objects like iron tweezers. The nozzle may be damaged, resulting in non-ejection if the objects touch the nozzle or other parts.  
Use gloves and remove ink clots by pinching them with a clean stick or your fingers.

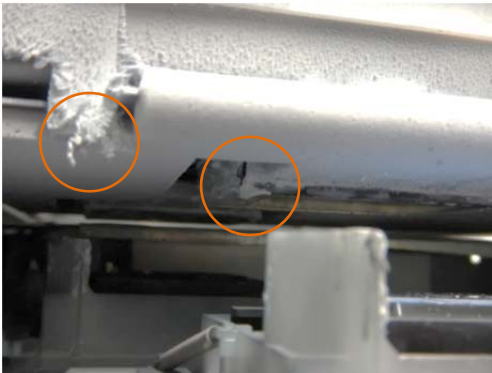

(11) Clean the top of the steel plate next to the flushing foam.

Cleaning location

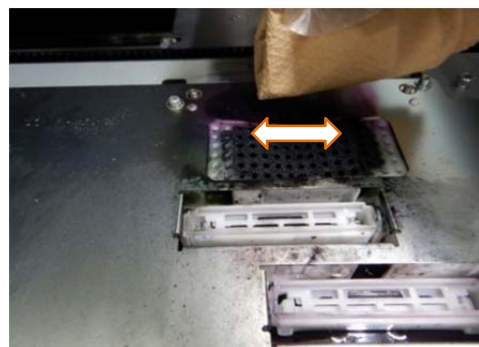
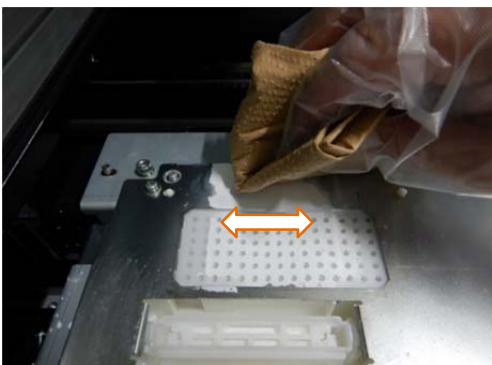
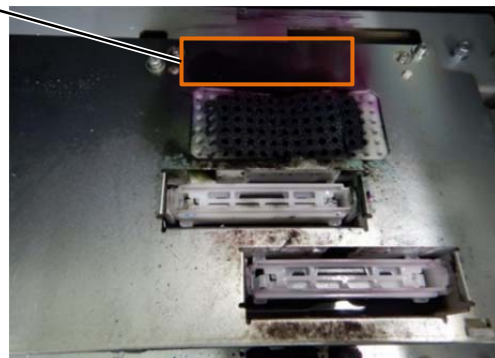
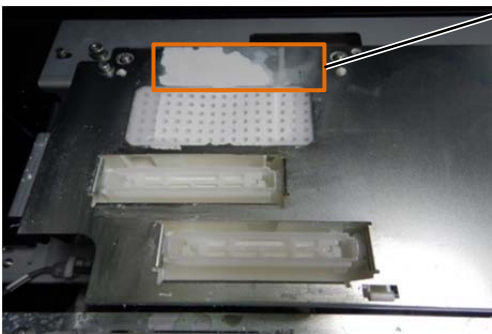





<CAUTION>

- Be sure to use a clean waste cloth. Using a waste cloth with pretreatment may lead to non-ejection.
- Do not rub the parts strongly. Doing so may damage the parts.
- Wipe in the direction of the arrow to prevent the peeled ink waste from entering the flushing foam and the wiper cleaning solution tank.

<TIPS>

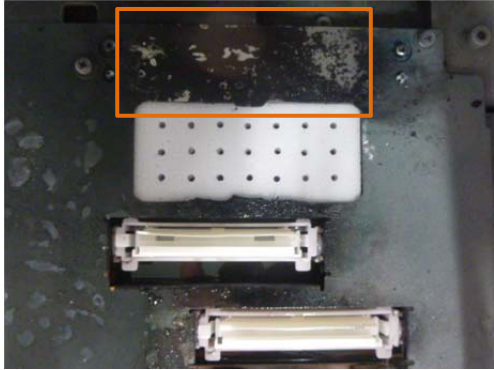
- If it is difficult to remove the ink built up, clean it with the cleaning solution for GTX-6 (GCX-6W09L/GCX-6W18L). When doing so, do not apply the cleaning solution directly to the top surface of the steel plate, but rather use a waste cloth soaked with the cleaning solution.

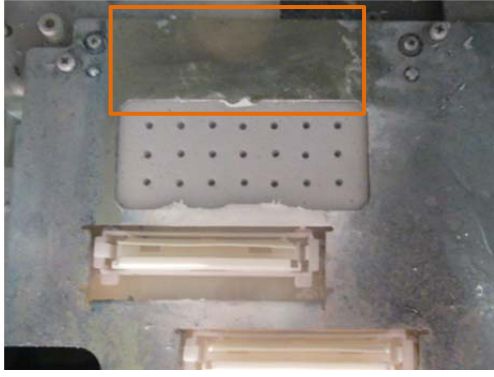
	Pre-cleaning state	Post-cleaning state
On the color side		
On the white side		

- (12) Place the tip of the new carriage foam on the sliding surface of the foam guide.
- (13) Move the foam along the sliding surface of the guide in the direction of the arrow, and move the carriage foam until it touches the two foam pads.

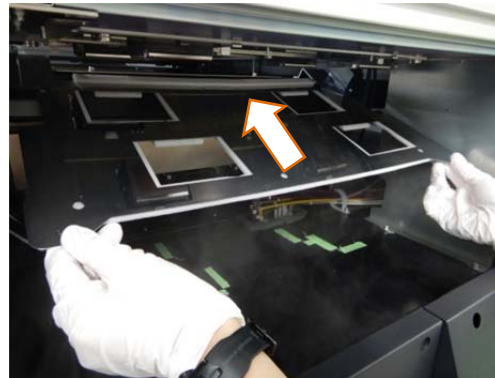
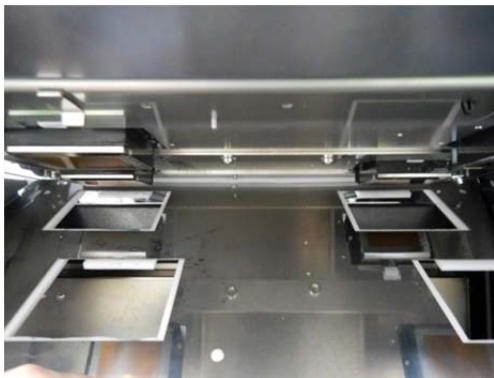
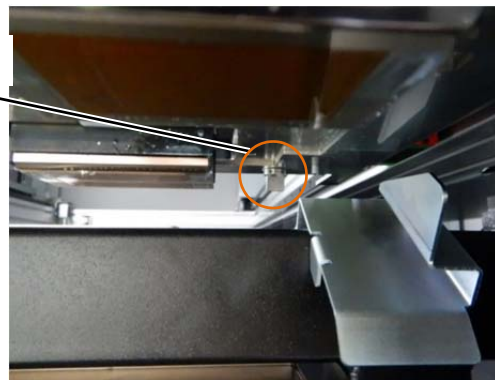
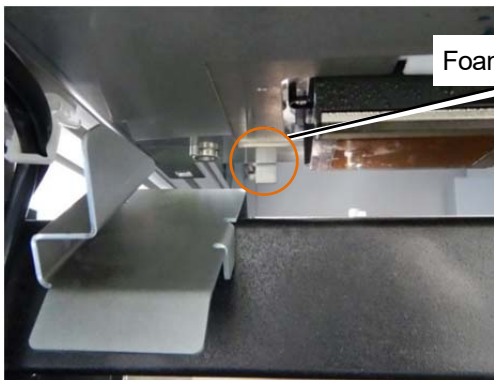
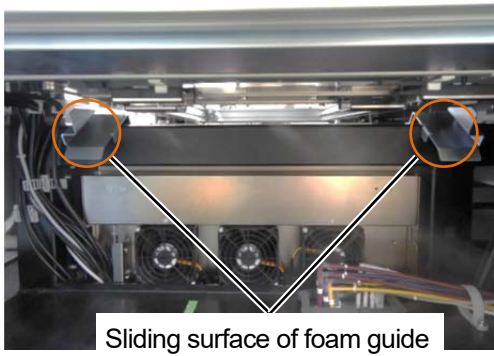

- (14) Rotate and assemble the foam to the magnet on the carriage.

Make sure that the carriage foam does not ride on the four foam pads.

<IMPORTANT>

- Be careful not to let the carriage foam come into contact with the nozzle surface of the head.

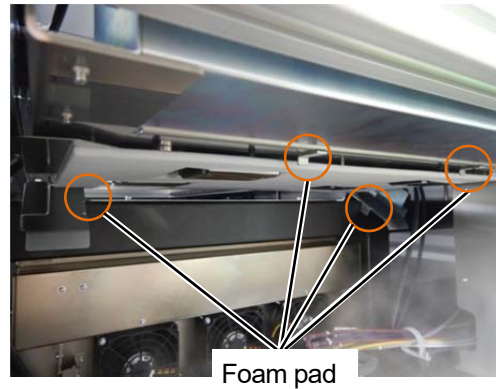

- (15) Make sure that the nozzle surface is below the bottom surface of the foam.

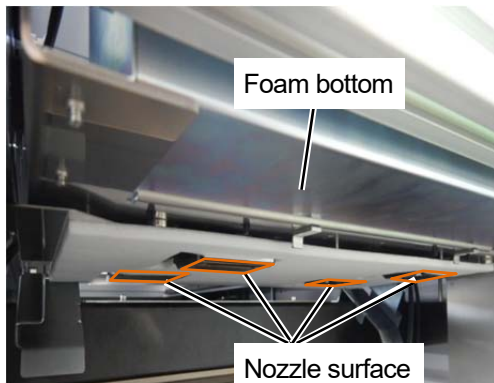



- (16) Close and lock the right-hand-side cover.

- (17) From the menu, select [Exit], and press .

## 6-1-10. Replacing the mist fan filter

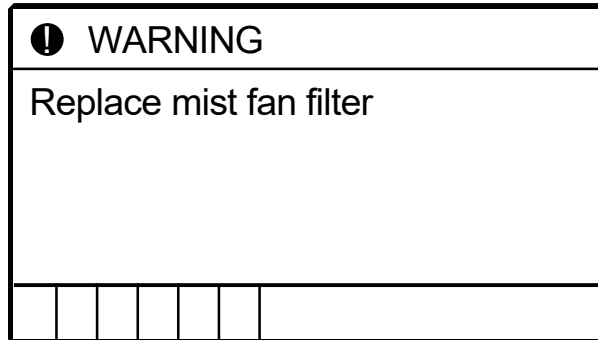
When a warning message appears in the warning message window, replace the mist fan filter with a new one. The inside of the main unit may become dirty with mist, which may cause a malfunction if you continue using the mist fan filter without replacement.



- (1) Prepare gloves and a new mist fan filter.
- (2) From the menu, select [Maintenance] > [Maintenance Part Clean/Replace] > [Clean nozzle guard and cap], and press .
- (3) Select [Replace mist fan filter], and press .

### <IMPORTANT>

- If any other error or message is displayed on the operation panel or warning message window, follow the message to solve the problem, then perform the cleaning.

### <TIPS>

- Pressing  causes the platen to start moving. Do not put anything around the platen.

- (4) Push in and open the mist fan door.

### <NOTE>

- For a proper work operation, be sure to wear the printer-provided gloves.





- (5) Hold the grip and remove the mist fan filter.

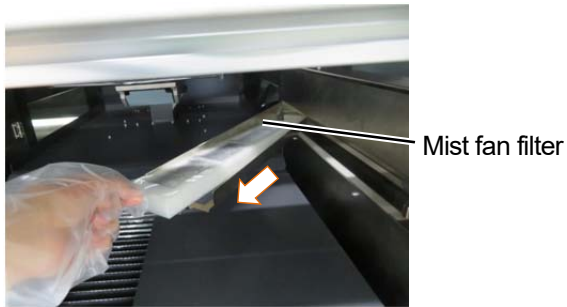

- (6) Insert a new mist fan filter and push in and close the mist fan door.

<CAUTION>

- Insert the mist fan filter completely, on the side with the grip facing upward.

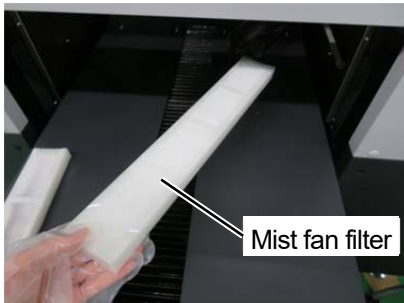

- (7) Replace the other one in the same way.

- (8) Press  by following the on-screen instructions to finish the work.

<NOTE>

- Dispose of any waste resulting from the replacement in accordance with applicable laws and ordinances.

## 6-1-11. Replacing the platen sheet

When the platen sheet gets soiled, replace it with a new one.

- (1) Remove the platen from the main unit of the printer. "5-4-1. Replacing the currently used platen with another one >>P.5-14"

- (2) Peel the platen sheet off the platen.

<TIPS>

- When it is hard to peel the platen sheet off, warm it using a hair dryer or the like and peel it off.

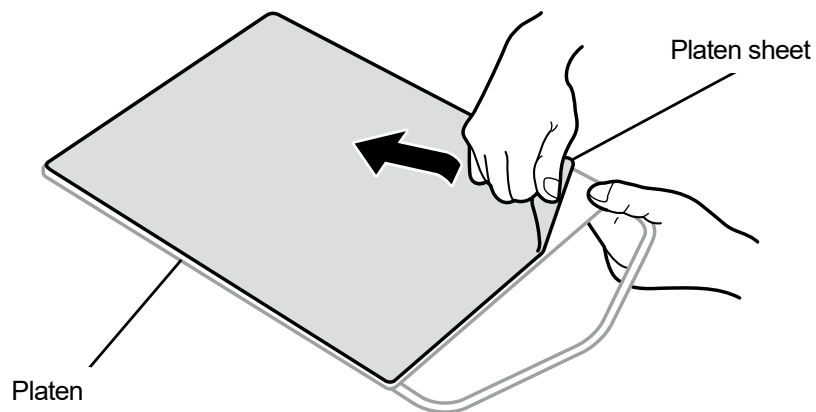

X1027

- (3) Wipe the surface of the platen with a clean cloth moistened with a mild detergent which is diluted with water, then wipe the platen clean with a dry and soft clean cloth.
- (4) Mount the platen in the main unit of the printer. "5-4-1. Replacing the currently used platen with another one >>P.5-14"
- (5) Peel the release paper (small in size) off a new platen sheet.

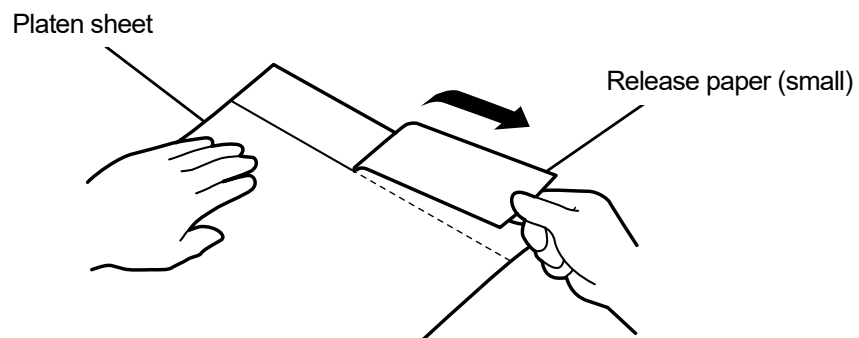

X1028

- (6) Position the platen sheet to match the platen surface, and onto the platen, stick the portion of the platen sheet where the release paper (small) was removed.

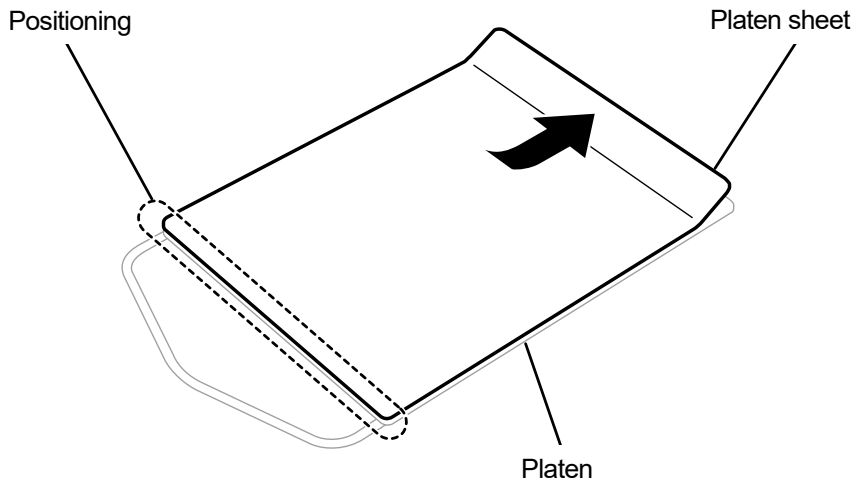

X1029

- (7) Peel off the rest of the release paper, and paste the whole platen sheet onto the entire platen.

<TIPS>

- Straighten the platen sheet, and stick it properly while pressing it with hands outward from the center to avoid making wrinkles.

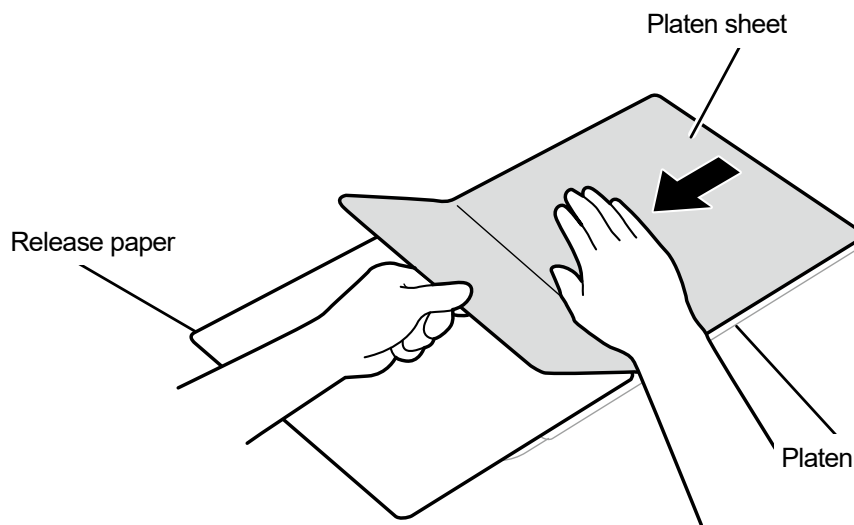

X1030

- (8) As required, print a grid pattern onto the new platen sheet. ☞"4-6-4. Print a grid pattern on the platen sheet

>>P.4-51"

<TIPS>

- After the printing is completed, press down the printed surface lightly with a dry cloth or a sheet of paper to dry the ink.

## 6-1-12. Replacement of print head

If a problem of non-ejection of ink-jet droplets is not cleared even after cleaning the head nozzle, replace a The print head with a new one.

Check the head position of the corresponding print head with the non-ejection of ink-jet droplets in the nozzle check pattern, and replace the print head by following the procedure. ☞"6-1-17. Print out the nozzle check pattern (checking on the print heads) >>P.6-44"

### <TIPS>

- Do not confuse the color side print head with the white side print head.  
Check the case color (red for the color side, white for the white side) and replace the case.
- Both color print head and white print head have side A and side B. Be sure to set them correctly.
- Ink needs to be re-installed after replacing the print head. If the ink level is low, refill ink.

(1) From the menu, select [Maintenance] > [Head Replacement] > [Corresponding print head], and press .

(2) Follow the on-screen message and turn off the power.

### <IMPORTANT>

- Please complete the task within 15 minutes, in order to prevent the print heads from drying up.

(3) Unlock the upper left-hand-side cover and top cover and open them.

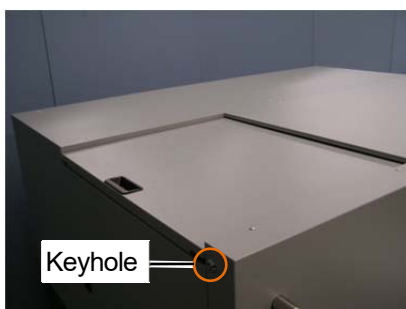

(4) Remove the upper case of a new print head.

(5) Remove four caps from the new print head.

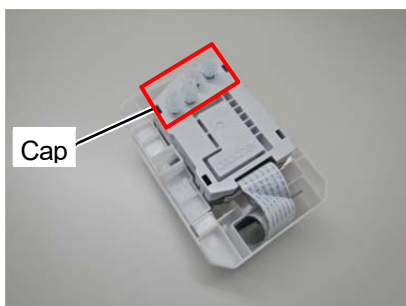

- (6) Remove each tube from the print head to be replaced with a new one. Then attach each of the new caps which are removed from a new print head to each tube, while exercising care to prevent any ink from being spilled.

<IMPORTANT>

- Care is needed in preventing any ink from being spilled from each tube. If the ink is dripping, wipe off the dripping ink.

<NOTE>

- For a proper work operation, be sure to wear the printer-provided gloves.

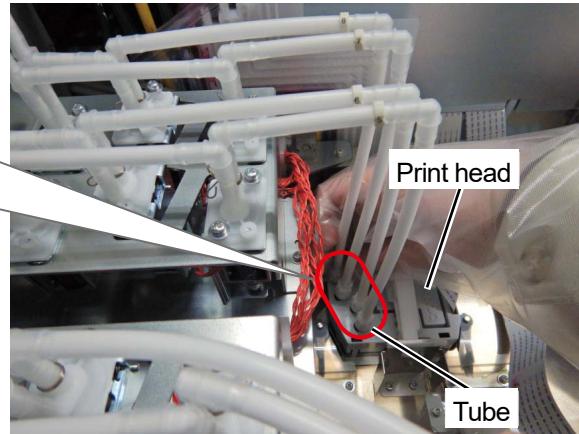
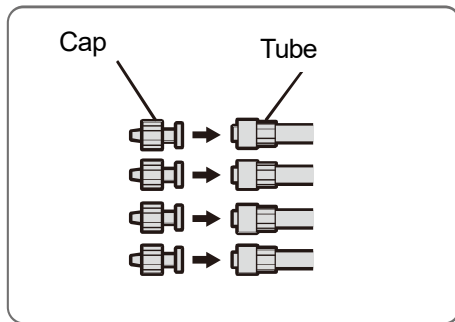

X1005

- (7) Remove the latch on the carriage board cover and open the cover.

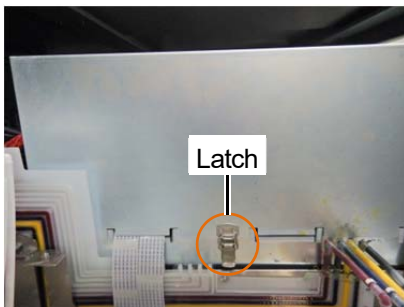

- (8) Remove the head board of the corresponding print head.

<CAUTION>

- Be sure not to touch other boards.

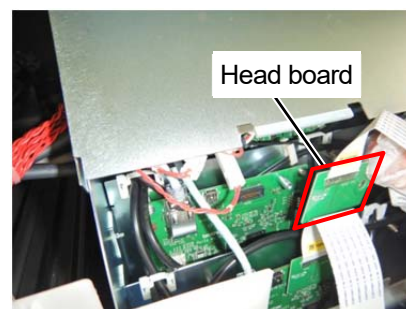
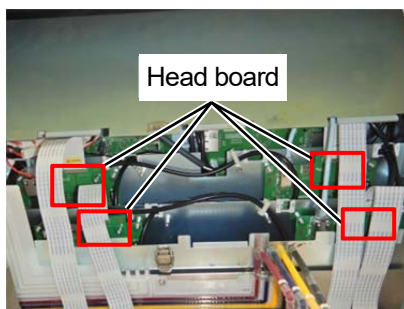

- (9) Remove the hook and clamp and disconnect the flat cable.

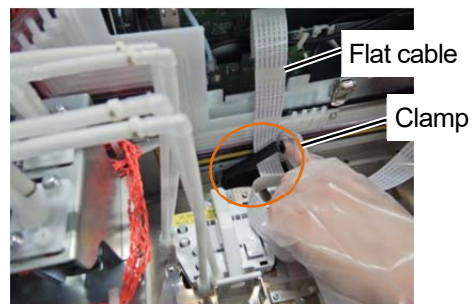
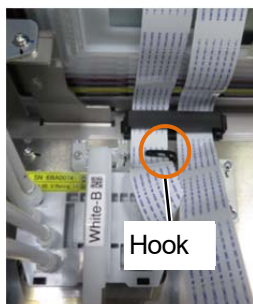

**(10)** Unlock the print head, and remove the print head.

<IMPORTANT>

- When removing the print head, be careful not to drip the ink on the carriage plate. If the ink is dripping, wipe off the dripping ink.

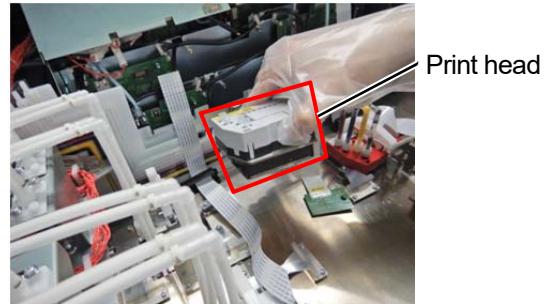
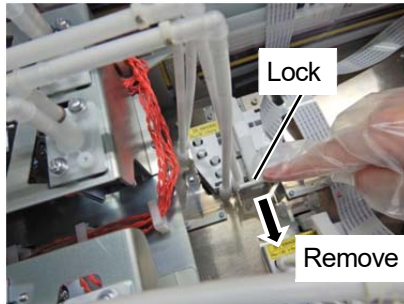

**(11)** Release the lock by pulling part (a) on the case to the left and take out the new print head from its case.

<IMPORTANT>

- When removing the print head, be careful not to touch the nozzle surface at the bottom of the head. Otherwise it may cause poor printing.

<TIPS>

- Sometimes, you may find it hard to remove the print head when you try to open the lock of (a) part. If it is hard, use both hands to remove it.

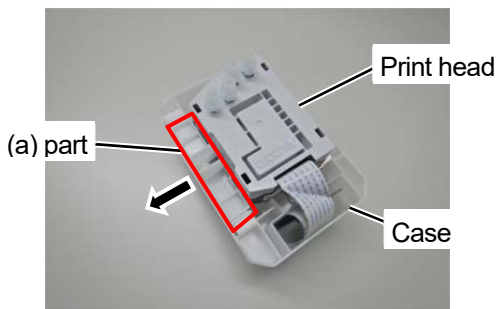

**(12)** Mount the new print head onto the carriage and push in the lock bar of the print head to lock the print head.

<IMPORTANT>

- Be careful not to pinch the flat cable between the metal plate of the print head and the carriage.
- Be careful not to let the metal plate of the print head ride on the positioning part.
- Be careful not to touch the lock of the other head and release the lock.

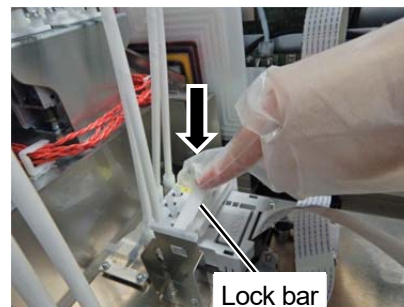
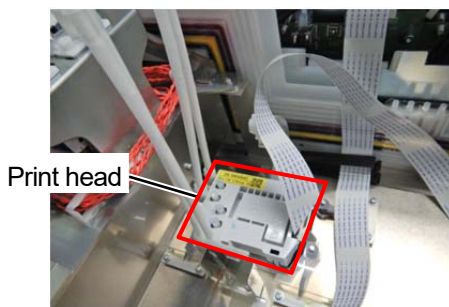



(13) Connect the head board aligned with the positioning pins on the carriage board.

<IMPORTANT>

- After connecting, check that the head board is not tilted.

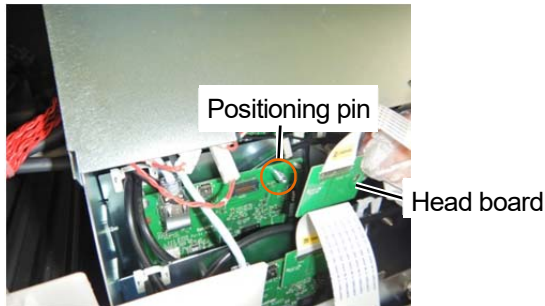

(14) Place the flat cable in the hook and clamp on the carriage.

<CAUTION>

- Ensure that the flat cable for head A does not overlap with that for head B.
- Extend the flat cable on the print head side toward the carriage board so that the flat cable will not bend.
- Fold the flat cable on the print head side.

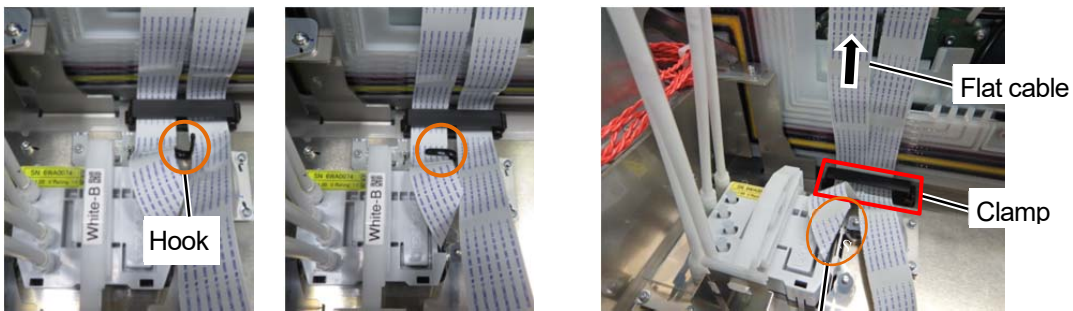

Fold the flat cable

(15) Close the carriage board cover.

<IMPORTANT>

- Make sure that the latch is securely closed.
- Ensure that the flat cables do not extend past the edge of the cover.

<CAUTION>

- Ensure that the flat cable for head A does not overlap with that for head B.

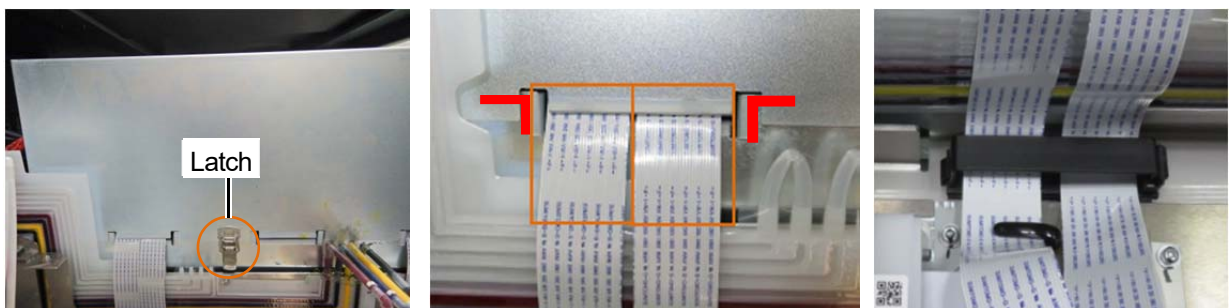

(16) Remove the cap you connected in step (6) from the tube, and connect the tubes to the print head.

<IMPORTANT>

- Check the stamp on the print head and the tube number, and make sure that they are connected in the correct position. Incorrectly connecting them may cause the ink to leak during the circulation.

<CAUTION>

- Ensure that the flat cables do not extend past the edge of the cover.

(17) Tighten the nut firmly until it stops so that each tube is fixed to the print head.

Head A side	1	2	3	4
Head B side	5	6	7	8

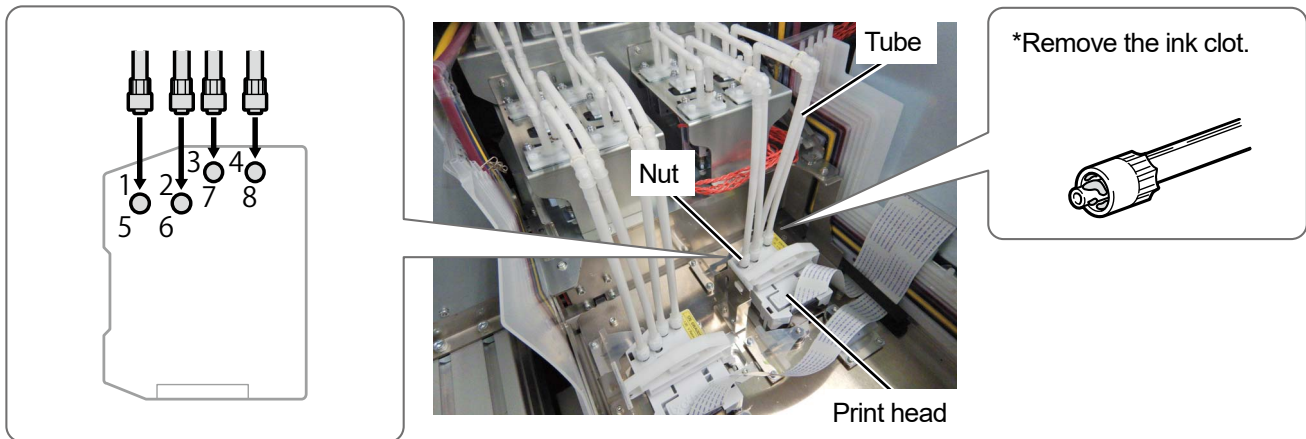

X1009

(18) Close the upper left-hand-side cover and top cover and turn on the power.

(19) From the menu, select [Maintenance] > [Install Ink after Replacing Head] > [Corresponding print head], and press



Perform the work operation by following the on-screen instructions.

<TIPS>

- After the procedures are completed, the current screen will go back to the standby mode screen.
- Replace other print heads in the same way.

(20) Print the nozzle check patterns. ☞"6-1-17. Print out the nozzle check pattern (checking on the print heads)  
>>P.6-44"

(21) Perform the initial settings after head replacement configuration. ☞"3-6-1. Initial settings after head replacement  
>>P.3-24"

(22) After color head replacement, if any, make color adjustment for 2 color heads. ☞"3-6-2. Color adjustments between the two color heads >> P.3-25"

(23) Adjust the ejection timing of the print head. ☞"3-6-3. Firing adjustment >>P.3-26"

(24) Make position adjustments for the 2 heads of the same color. ☞"3-6-4. 2 same color heads position adjustment  
>>P.3-27"

(25) Perform the platen feed adjustment. ☞"3-6-5. Platen-rolling adjustment >>P.3-28"

(26) Make the position adjustment between the white head and the color head. ☞"3-6-6. White/color alignment  
>>P.3-29"



### 6-1-13. Cover adjustments

Adjust each cover if they do not close smoothly.

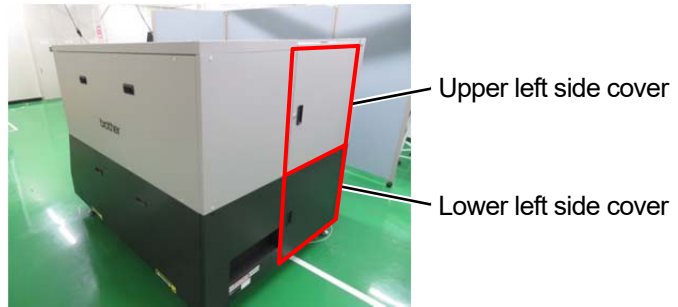

### Tilt adjustments

(1) Turn the adjustment screw on the front side clockwise or counterclockwise to make adjustments if a cover is tilted.

Turn the adjustment screw clockwise to lower the cover and counterclockwise to raise the cover.

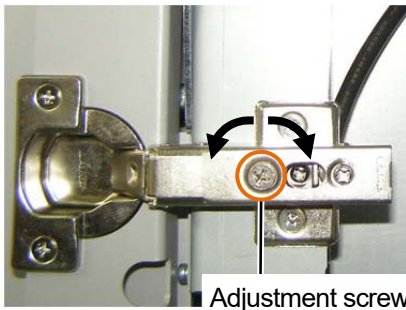
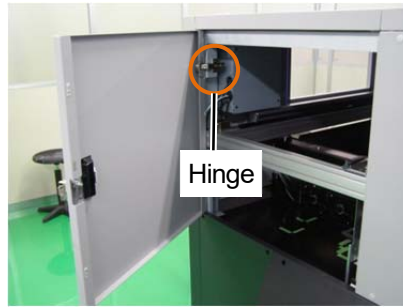
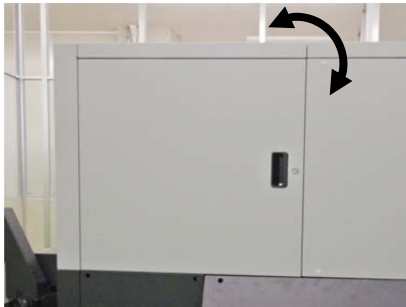

### Left/right adjustments

- (1) Turn the adjustment screw on the front side clockwise or counterclockwise to make adjustments if the cover interferes with the adjacent cover. Turn the adjustment screw clockwise to reduce the clearance and counterclockwise to increase the clearance.

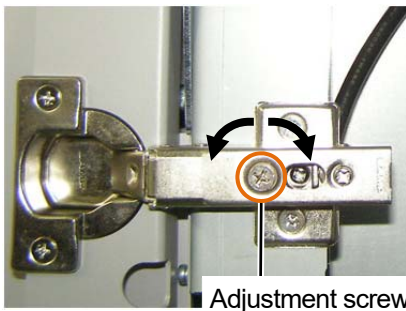
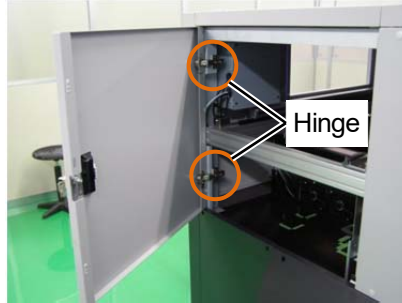

### Up/Down adjustments

- (1) Turn the adjustment screw in the center clockwise or counterclockwise to make up and down adjustments. Turn the adjustment screw clockwise to raise the cover and counterclockwise to lower the cover.

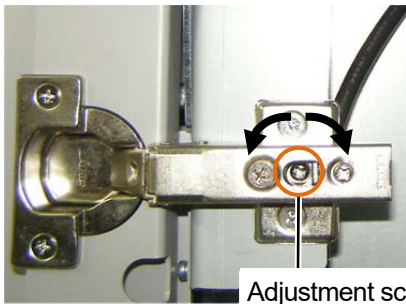
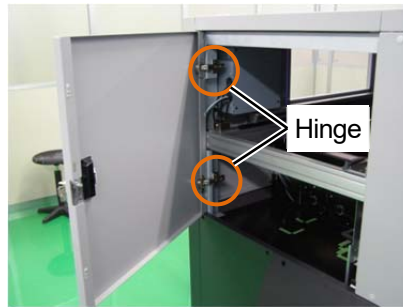
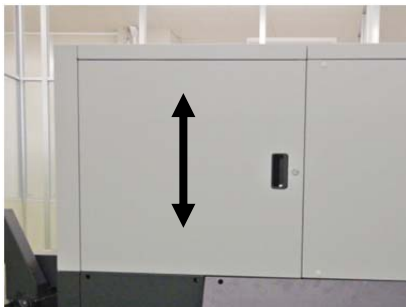

## Back/Forth adjustments



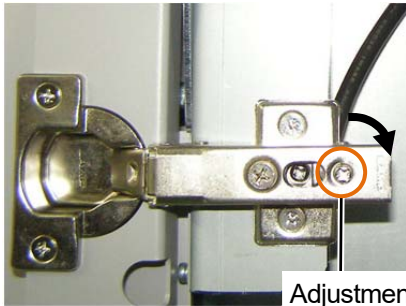
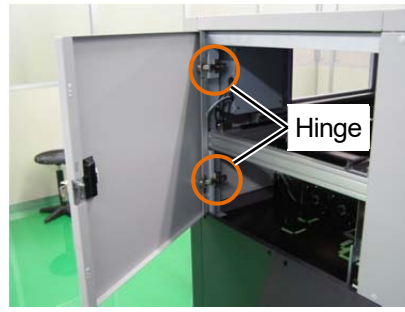

- (1) Turn the adjustment screw On the inside clockwise to make back and forth adjustments.





Adjustment screw

## 6-1-14. Tube air bleed

If air is mixed in the print head or tube and ink non-ejection is not improved, bleed the air in the tube.

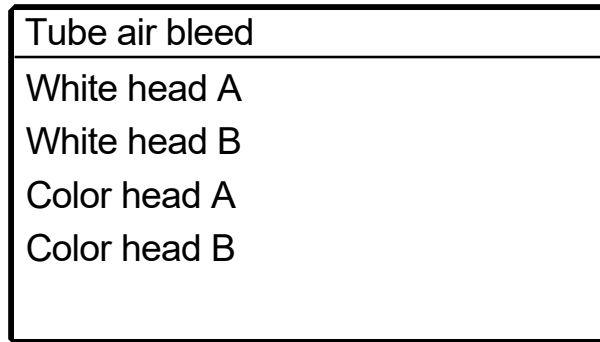
- (1) While the printer is in standby mode, press  on the operation panel to bring the menu screen into view.
- (2) Press  / , select [Maintenance] > [Tube air bleed], and press .
- (3) Select the item you want to bleed air from and press .



- (4) Select the color you want to bleed air from and press .

<TIPS>

- Select the number for the white head.  "6-1-12. Replacement of print head">>P.6-32"

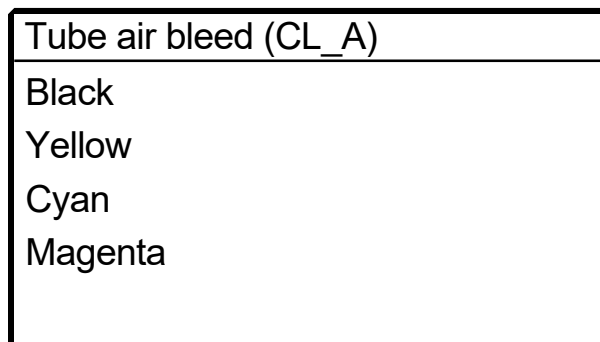

- (5) Follow the message displayed on screen, press  on the operation panel.  
Air bleeding in the tube is executed.

## 6-1-15. Head cleaning

This printer has been designed to perform the Auto Cleaning every time 72 print jobs are printed after the previous Auto Cleaning, or before starting the printing using the white ink when one hour or more elapses after the previous printing that used the white ink.

### <TIPS>



- The frequency and start timing of Auto Cleaning can be changed. ☞"7-12. Auto Cleaning Setting >>P.7-10"

In the event that there is any faintly printed or missing portion on a printed material, head cleaning sometimes provides a solution.

### Selecting a type of head cleaning from the menu to perform the head cleaning

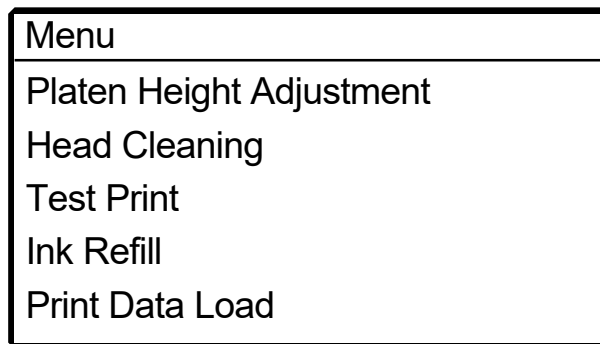
- While the printer is in standby mode, press  on the operation panel to bring the menu screen into view.
- From the menu, select [Head Cleaning], and press .



- By pressing  / , select one of the options: [Normal Cleaning], [Powerful Cleaning] or [Super Cleaning], and press .

### <TIPS>

- For selecting a desired cleaning option, follow the instructions in the respective steps. ☞"8-2-1. Recovery action to be taken for such a nozzle that is unable to eject ink-jet droplets >>P.8-13"

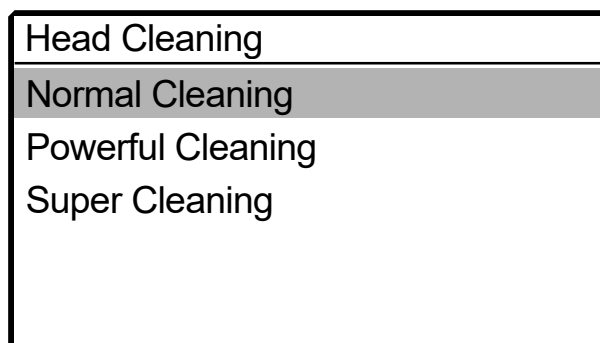

- (4) By pressing ▲/▼, select [All Colors], [All Whites], or [All Print Heads], and press .

<TIPS>

- Under the condition that the nozzle which has been confirmed not ejecting ink-jet droplets, determine the color for which the head cleaning should be performed.  "6-1-17. Print out the nozzle check pattern (checking on the print heads) >>P.6-44"

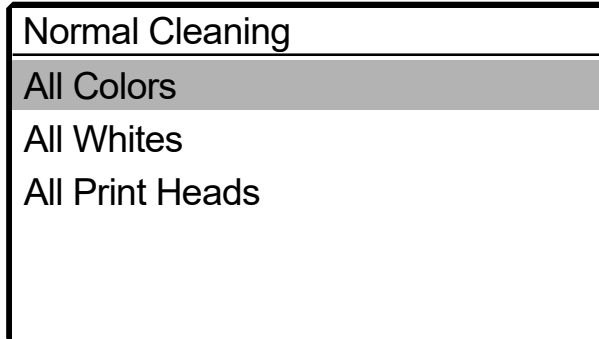

- (5) Then, the head cleaning will be performed for the specified print heads.

<TIPS>

- The cleaning operation cannot be canceled halfway.
- After the procedures are completed, the current screen will go back to the standby mode screen.

## 6-1-16. White ink circulation

When whiteness is not enough, it may be solved by performing white ink circulation.

- (1) While the printer is in standby mode, press  on the operation panel to bring the menu screen into view.
- (2) From the menu, select [Maintenance] > [White Ink Circulation], and press .

### <IMPORTANT>

- Do not turn off the power because if you do so, the printer may fail because necessary maintenance operations are not performed.

### <TIPS>

- Completing the white ink circulation varies depending on the ambient temperature. Usually, it takes about 8-9 minutes and up to 15 minutes. White ink is circulated automatically every four hours, and white ink three times as much as normal is circulated every 24 hours.
- If you are activating the printer after having had its power off for a long period, it will take up to 4 hours depending on how long the power was off.

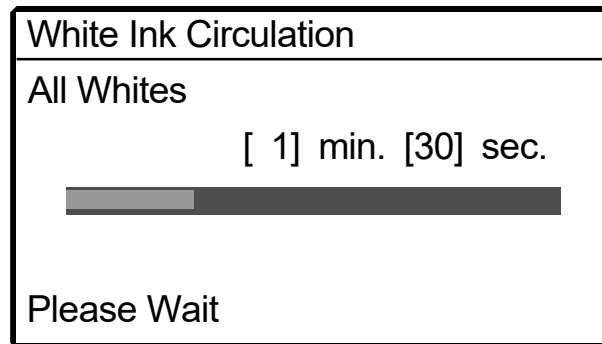

## 6-1-17. Print out the nozzle check pattern (checking on the print heads)

By printing out a nozzle check pattern, you can check on the printing quality.  
It is recommended to always perform this procedure to verify the output.

### <TIPS>

- The serial number, firmware version, print date (day/month/year), time, temperature, humidity, and the number of copies printed are printed at the bottom of the nozzle check pattern.  
The date and time will be printed in Coordinated Universal Time with "(UTC)" printed at the end if time adjustment as a maintenance tool has not been made. You can print the date and time according to your environment by making time adjustment. [☞"3-6-7. Setting of the time displayed on the nozzle check pattern >>P.3-30"](#)



- Put the platen 14×16 in place, and position its level at "A".  
[☞"5-4-1. Replacing the currently used platen with another one >>P.5-14"](#) and ["5-4-2. Platen height adjustment >>P.5-16"](#)
- As illustrated below, put the A4-size or letter-size white paper on the platen in alignment with the right-hand corner of the platen at its front edge.  
When the paper is loosely fitted, fix its edge with a tape or the like.  
A T-shirt can also be used instead.

### <TIPS>

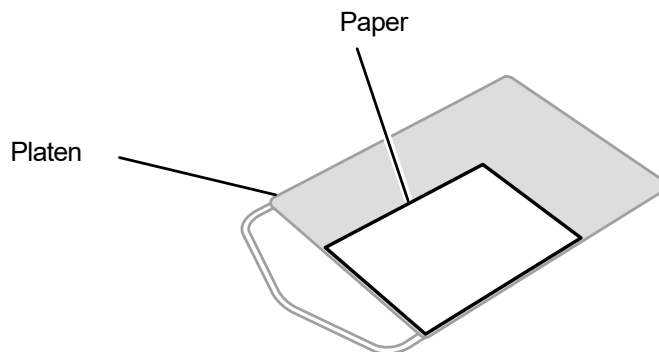
- When printing out a nozzle check pattern on the white side, print it on a pretreated black or dark color textile or black paper, or a transparent sheet (such as OHP sheet).



X1022

- From the menu, select [Test Print] > [Nozzle Check CMYK], and press .  
Then, printing will begin.
- After printing on the color side is completed, remove the printed paper and replace it with a paper for printing on the white side.
- From the menu, select [Test Print] > [Nozzle Check White], and press .  
Then, printing will begin.



- (6) Check to see if the printed result of both sides are acceptable, and if no ink-jet droplets have been ejected, perform a head cleaning for print heads. ➡"6-1-15. Head cleaning >>P.6-41"

<IMPORTANT>

- If the print result shows an intermittent line, non-ejection has occurred. A head cleaning should be performed on the print head that has a poor nozzle check result.
- Even if the lines of the white-side printed result are light, since white ink is fired from more than one nozzle on the same place, the quality is not affected.

<TIPS>

- The following items are printed at the bottom of the nozzle check pattern:
  - Serial number
  - Temperature
  - Firmware version
  - Humidity
  - Print date (day/month/year)
  - Number of prints
  - Time
- The name of the corresponding head (head A or B) is printed next to each nozzle check pattern.

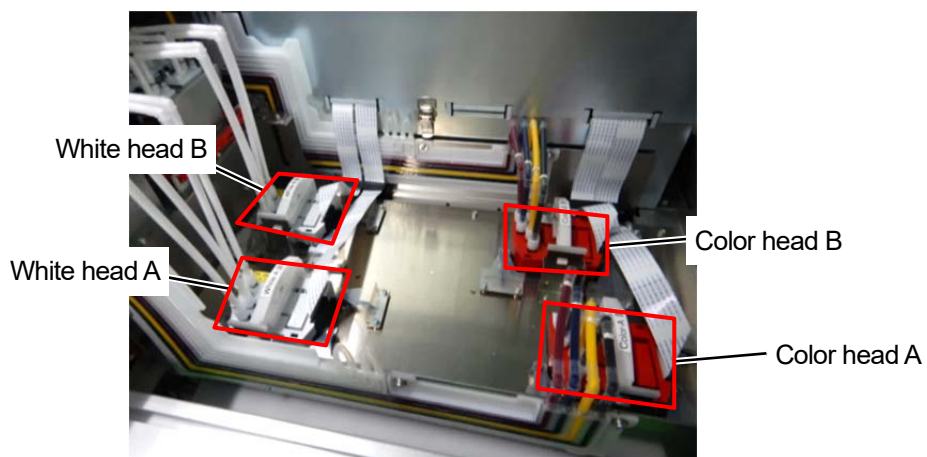
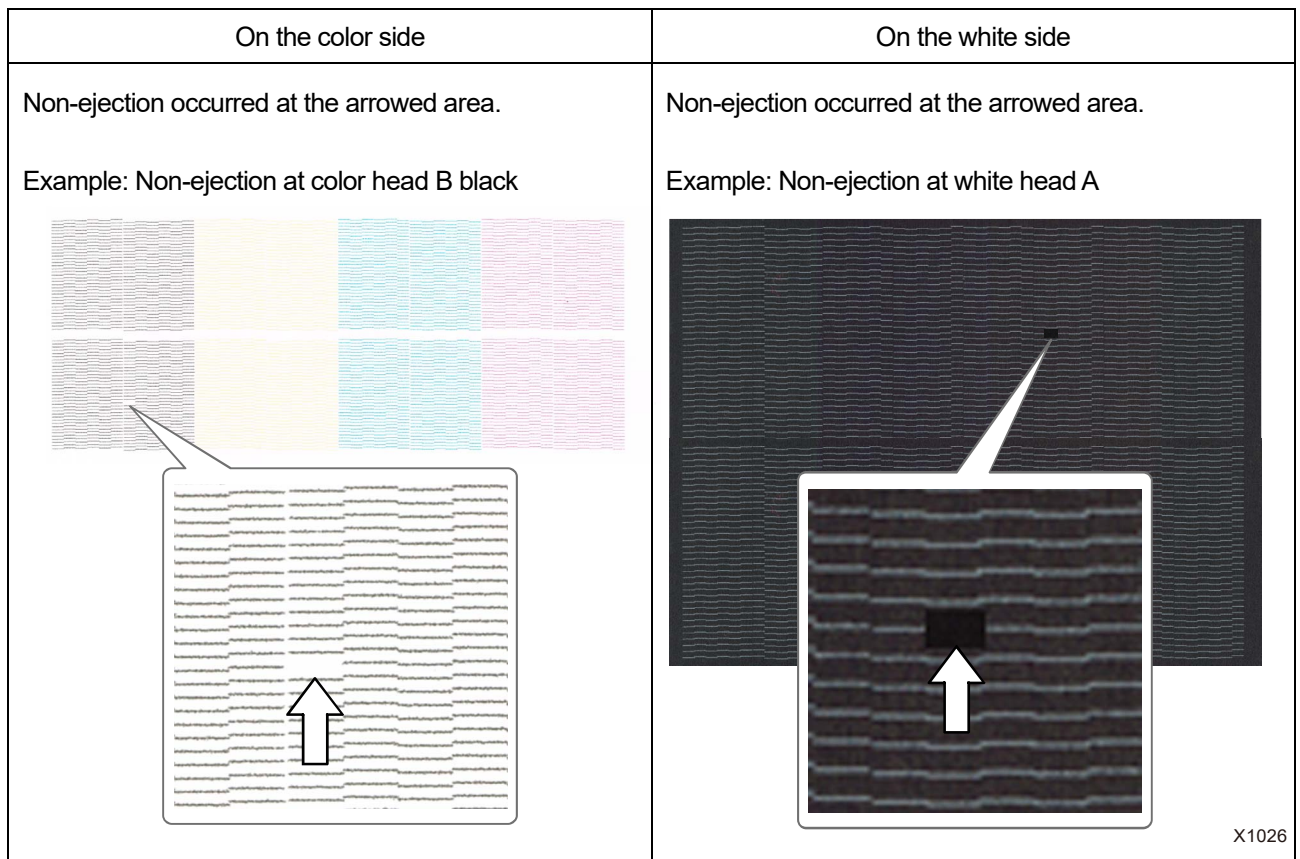

## 6-2. Cleaning

### 6-2-1. Cleaning the nozzle guard and suction cap

When a warning message appears in the warning message window, perform the cleaning.

In the event that maintenance has been performed inadequately, a printed material may be soiled with waste ink during a print session or a printed surface quality may deteriorate.

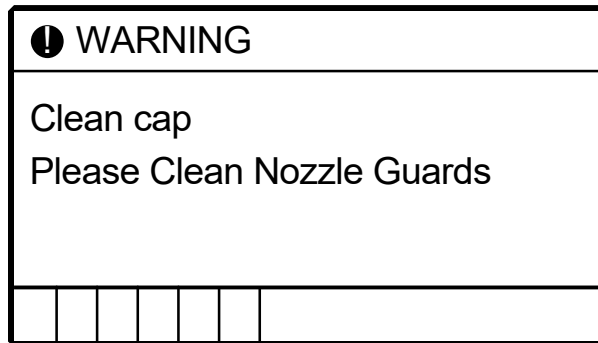

(1) Make the clean stick R, clean stick T, cleaning cup, gloves and cleaning solution, which come standard with the printer, available for use.

(2) From the menu, select [Maintenance] > [Maintenance Part Clean/Replace] > [Clean nozzle guard and cap], and press .

(3) Select  in response to the instructions on the screen.

<IMPORTANT>

- If any other error or message is displayed on the operation panel or warning message window, follow the message to solve the problem, then perform the cleaning.

<TIPS>

- Pressing  causes the platen to start moving. Do not put anything around the platen.

(4) Follow the on-screen message and start working.

<IMPORTANT>

- Please complete the task within 15 minutes, in order to prevent the print heads from drying up.
- Then, the head cleaning can be performed to prevent any ink from drying up.

- (5) Unlock the upper left-hand-side cover and top cover and clean the suction cap.  
 Unlock and open the right-hand-side cover and clean the nozzle guard.  
 Two types of clean sticks are provided. Use either the clean stick T or R depending on what you want to clean.

<TIPS>

- For the cleaning method, refer to the description mentioned below.

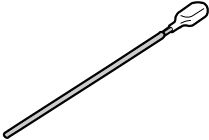
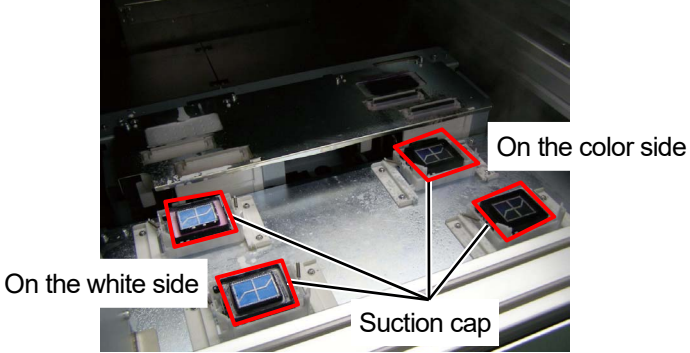
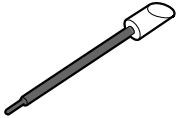
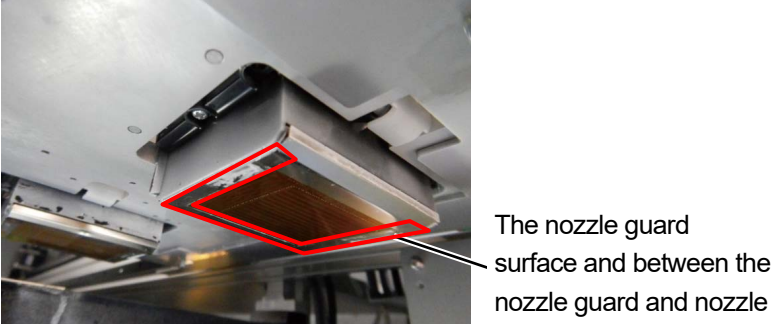
<p>Locations to be cleaned with clean stick T</p> 	
<p>Locations to be cleaned with clean stick R</p> 	

X1013

- (6) After the cleaning is completed, close all the covers.

<NOTE>

- Dispose of any waste resulting from the cleaning in accordance with applicable laws and ordinances.

<TIPS>

- Then, the head cleaning will be performed to prevent any ink from drying up.
- Because the cleaning cup will be reused, rinse it in clean cleaning solution and store it in a safe place.

The nozzle guard and suction cap should be cleaned separately for the white side and color side.

For the way to perform cleaning, refer to the respective items.

## 1 Perform cleaning of the white side.

Prepare a new clean stick R and the cleaning solution.

### Nozzle guard Cleaning

Perform cleaning of the nozzle guard part on the white side.

☞ "Cleaning the nozzle guard (Use clean stick R) >>P.6-49"

After cleaning the nozzle guard part, remove ink clots, if any, protruding from the nozzle surface.

Prepare a new clean stick T and the cleaning solution.

### Cleaning suction cap

Perform cleaning of the suction cap part on the white side.

☞ "Cleaning suction cap (Use clean stick T) >>P.6-52"

## 2 Perform cleaning of the color side.

Rinse the cleaning cup, and prepare a new clean stick R and the cleaning solution.

### Nozzle guard Cleaning

Perform cleaning of the nozzle guard part on the color side.

☞ "Cleaning the nozzle guard (Use clean stick R) >>P.6-49"

After cleaning the nozzle guard part, remove ink clots, if any, protruding from the nozzle surface.

Rinse the cleaning cup, and prepare a new clean stick T and the cleaning solution.

### Cleaning suction cap

Perform cleaning of the suction cap part on the color side.

☞ "Cleaning suction cap (Use clean stick T) >>P.6-52"

## 3 Clean the backside of the carriage.

## Cleaning the nozzle guard (Use clean stick R)

- (1) Put a proper amount of cleaning solution into the cleaning cup.
- (2) Moisten a new clean stick R with the cleaning solution.

### <IMPORTANT>

- Use a new clean stick R when you start cleaning.
- Never touch the tip end of clean stick R with your hand. If any sebaceous matter is attached to the wiper, it may result in a printer malfunction.
- Do not use other fluids (water, etc.), because they may damage the print heads.
- Do not return the cleaning solution which has been put in the cleaning cup to the cleaning solution bottle.
- Do not shed cleaning solution in the maintenance unit.

### <NOTE>

- For a proper work operation, be sure to wear the printer-provided gloves.

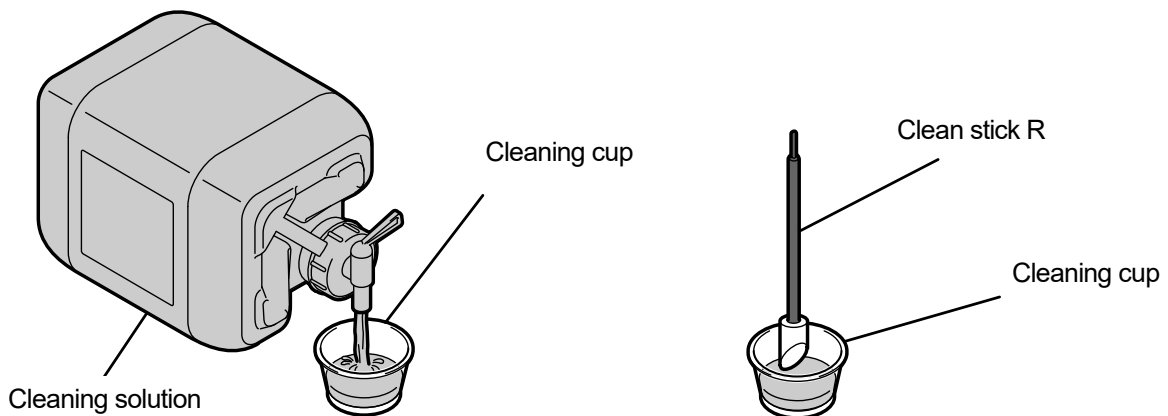

X1000

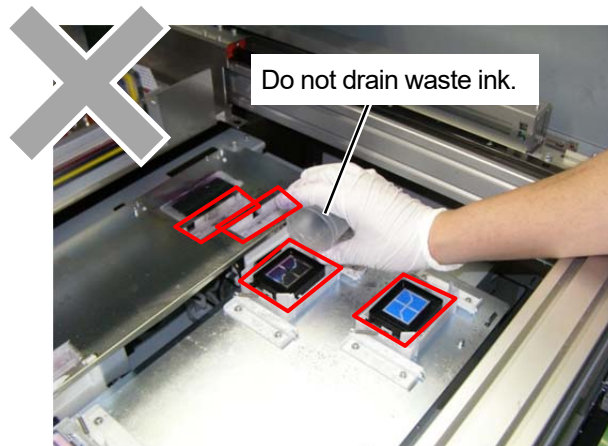

(3) Wipe the area between the print head's nozzle surface and nozzle guard.

<IMPORTANT>

- Be sure not to touch the red-frame zone of the nozzle surface.
- For cleaning, be sure not to use any tool other than clean stick R.
- Do not rub the nozzle strongly.

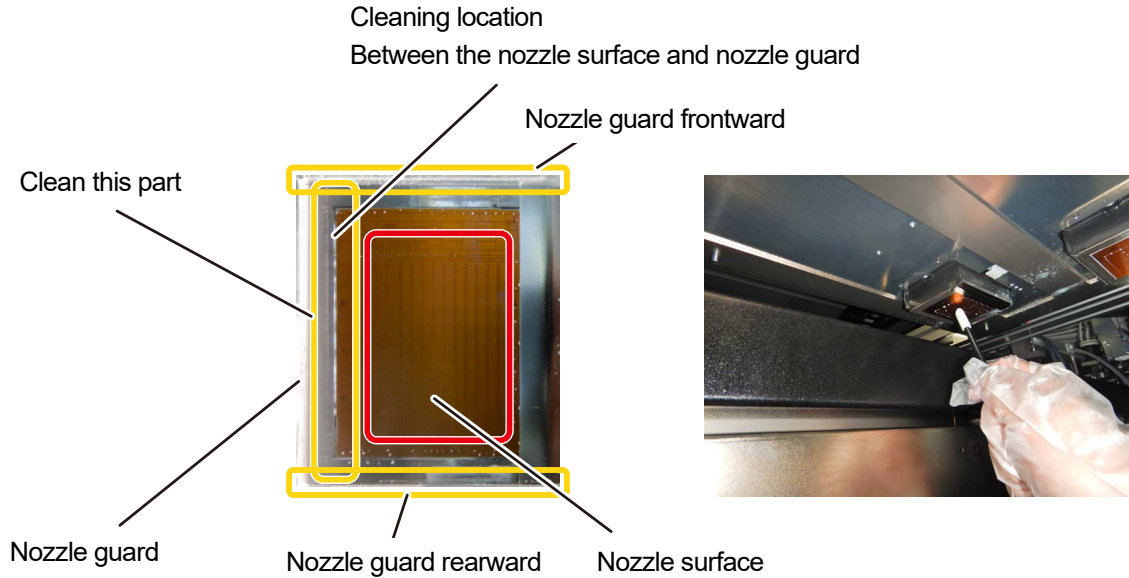

X1018

Cleaning conditions

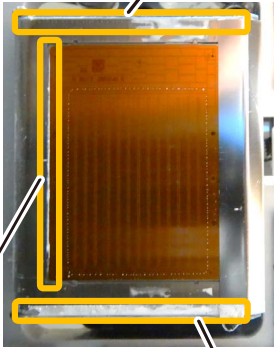
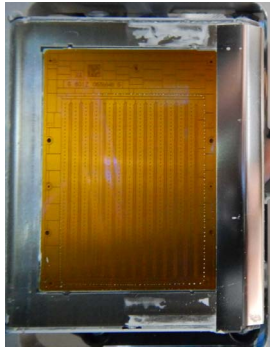
Pre-cleaning state	Post-cleaning state
<p>Cleaning location Nozzle guard frontward</p>  <p>Cleaning location Between the nozzle surface and nozzle guard</p> <p>Cleaning location Nozzle guard rearward</p>	

X1046

<IMPORTANT>

- Be sure to use the clean stick R separately for white ink and color ink.



- (4) Remove ink clots, if any, protruding from the nozzle surface on the underside of the carriage.

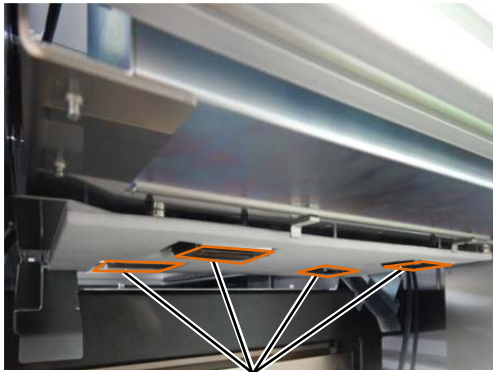

Nozzle surface

Ink clot example

<CAUTION>

- When removing ink clots, do not use hard objects like iron tweezers. The nozzle may be damaged, resulting in non-ejection if the objects touch the nozzle or other parts.  
Use gloves and remove ink clots by pinching them with a clean stick or your fingers.

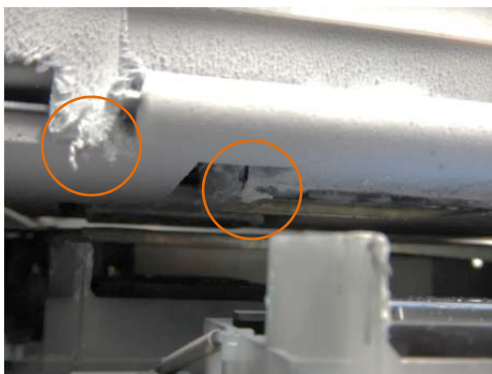

## Cleaning suction cap (Use clean stick T)

- (1) Wipe the lip of the suction cap in parallel with the side surface of the tip of clean stick T, and then wipe the outer frame in the same way.

### <IMPORTANT>

- Clean the lip of the suction cap with clean stick T. The print head dries and causes an ejection failure if solidified ink remains.
- Do not touch the sponge of the suction cap. The sponge may come off.
- Never touch the tip end of clean stick T with your hand. If any sebaceous matter is attached to the wiper, it may result in a printer malfunction.
- If ink clot floats on surface, remove it using the clean stick T. Do not use tweezers or other sharp objects. Using sharp objects could damage the suction cap and deteriorate its air tightness, possibly resulting in failure to eject ink-jet droplets.
- Be sure not to pinch the rubber seal. If it is damaged, its sealing property will be degraded, which in turn may lead to non-ejection of ink-jet droplets from the print heads.

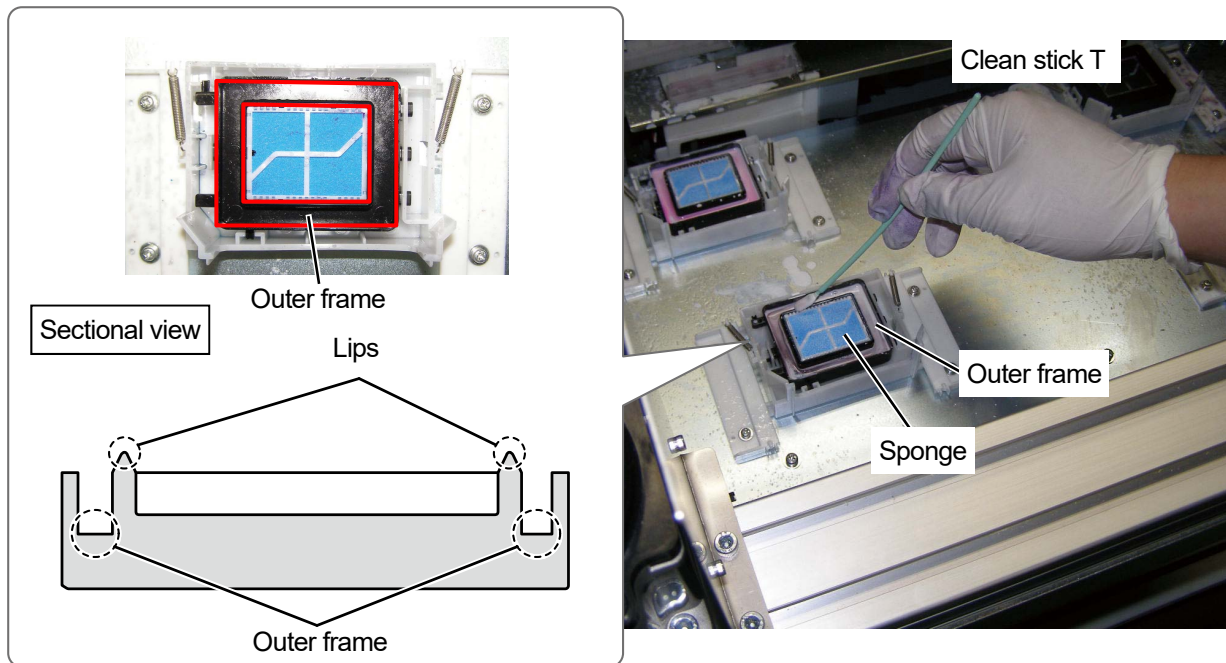

X1021

- (2) Replace clean stick T with clean stick R, rinse the cleaning cup, and clean the nozzle guard on the color side head.

### <IMPORTANT>

- Be sure to use the clean stick T separately for white ink and color ink.
- The used clean stick T should be disposed of, and should not be reused.
- After cleaning the nozzle guard of the color side head, rinse the cleaning cup with pure water, let it dry sufficiently, and store it so that dust does not get inside.

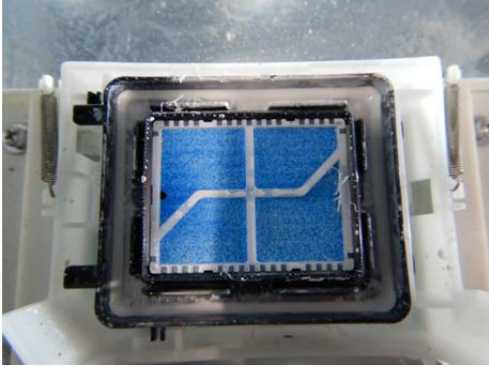
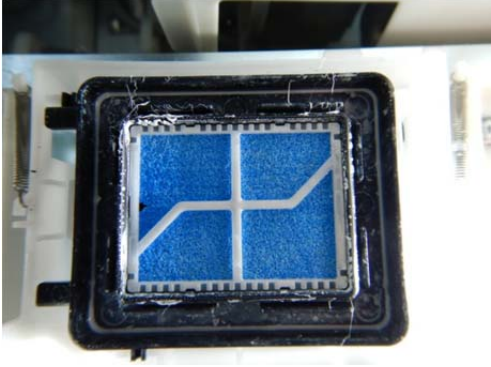

Cleaning conditions

Pre-cleaning state	Post-cleaning state
	

## Cleaning the backside of the carriage

- (1) Clean the area shown below on the backside of the carriage.

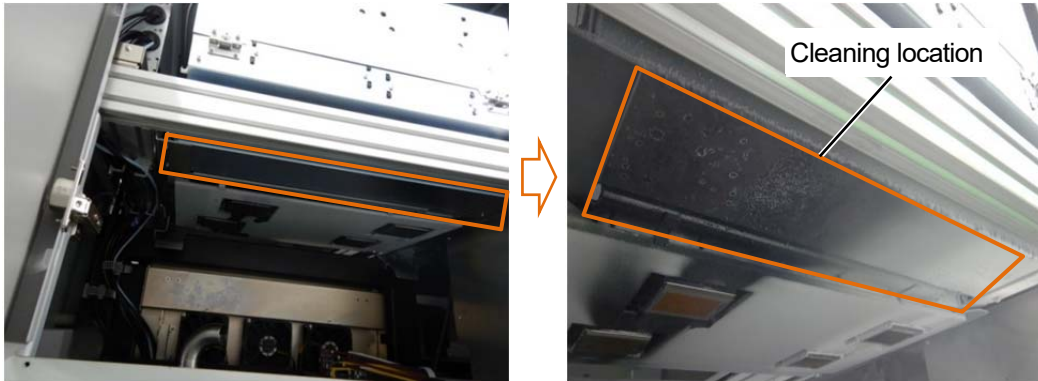

- (2) Use the clean stick R or waste cloth to clean the area.

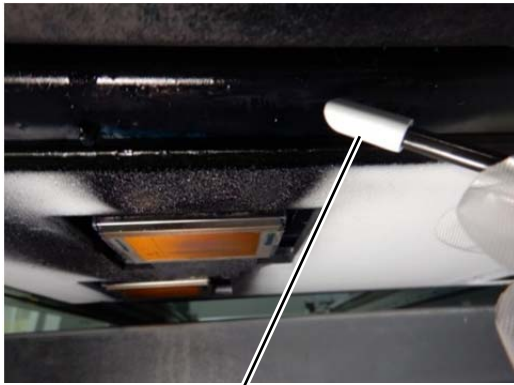

Absorb ink droplets with the clean stick R



Wipe off the adhered mist ink with a waste cloth

### <CAUTION>

- When cleaning the backside of the carriage with a waste cloth, make sure that the waste cloth will not touch the nozzle surface. The nozzle may be damaged, resulting in non-ejection if the objects touch the nozzle or other parts.

### <TIPS>

- Clean the white side in the same way.

Cleaning ink droplets

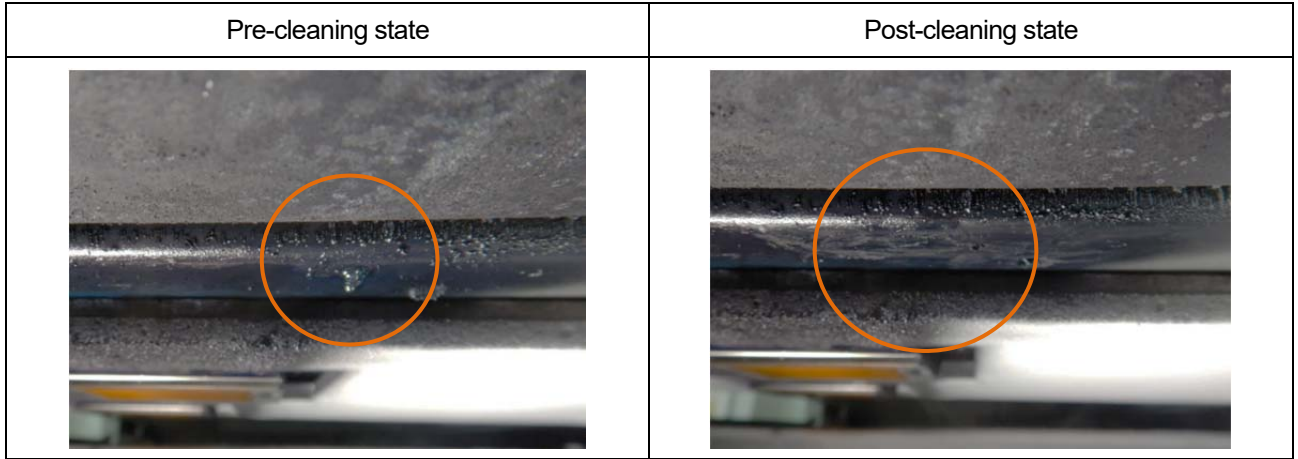

Mist-state ink

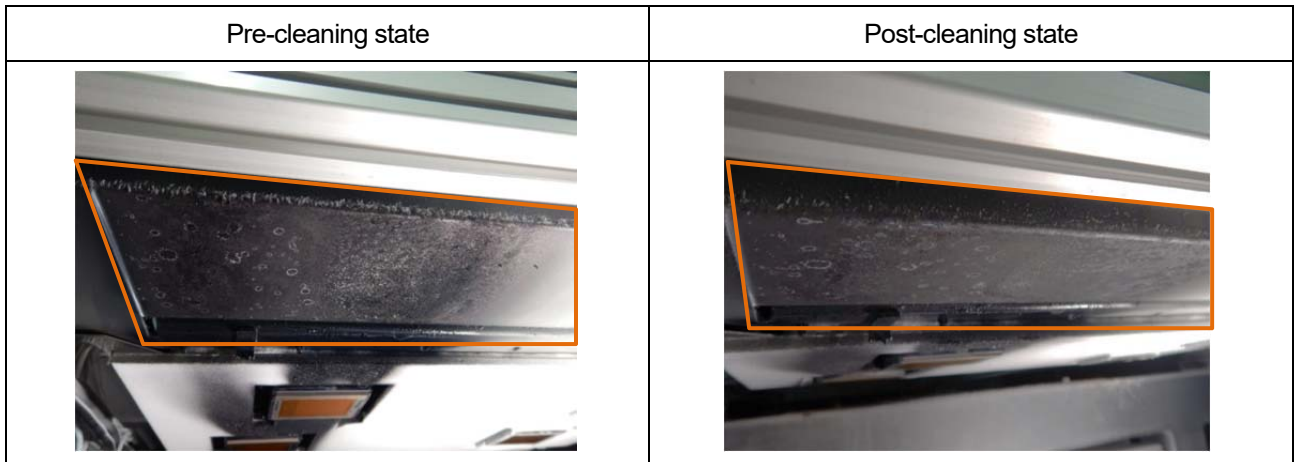

## 6-2-2. Cleaning and replacing maintenance parts

Clean the maintenance area, if it is dirty, when replacing the flushing foam.

- (1) Prepare a waste cloth.

<IMPORTANT>

- Please complete the task within 15 minutes, in order to prevent the print heads from drying up.
- Then, the head cleaning will be performed to prevent any ink from drying up.

- (2) Unlock the upper left-hand-side cover and top cover and open them.

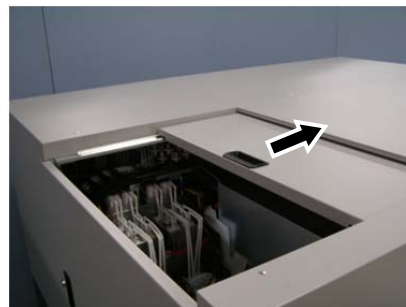
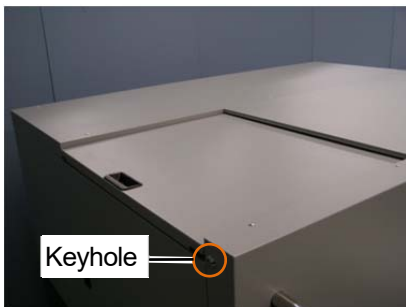

- (3) Wipe the red frame part with waste cloth.

<IMPORTANT>

- Please complete the task within 15 minutes in order to prevent the print heads from drying up.
- Be sure to use a clean waste cloth. Using a cloth with pretreatment may lead to non-ejection.
- Do not touch other parts such as springs and caps when wiping part (a), as shown in the photo. If you touch the spring, in particular, it may come off.
- Do not rub the parts strongly. Doing so may cause the parts to bend.
- Do not put the wiped ink waste in the wiper cleaning tank.

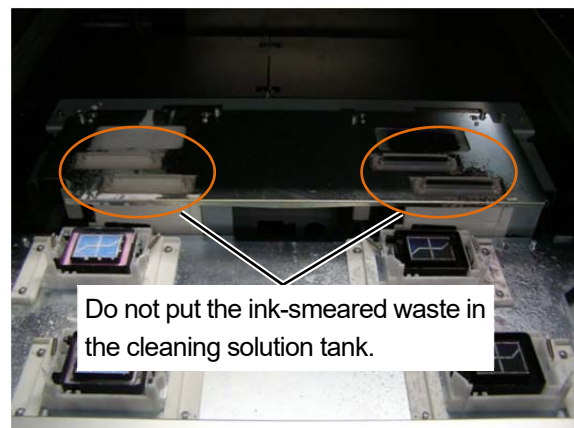
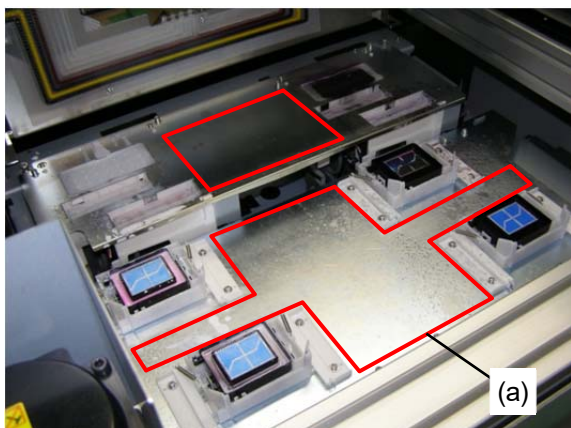

- (4) Close the upper left-hand-side cover and top cover.

<NOTE>

- Dispose of any waste resulting from the cleaning in accordance with applicable laws and ordinances.

### 6-2-3. Cleaning the surrounding area of nozzle surface

- (1) Make the clean stick R, cleaning cup, gloves and cleaning solution, which come standard with the printer, available for use.

<IMPORTANT>

- Use a new clean stick R when you start cleaning.
- Never touch the tip end of clean stick R with your hand. If any sebaceous matter is attached to the head nozzle, it may result in the printer malfunction.

- (2) From the menu, select [Maintenance] > [Maintenance Part Clean/Replace] > [Clean nozzle guard and cap], and press .

<IMPORTANT>

- If any other error or message is displayed on the operation panel or warning message window, follow the message to solve the problem, then perform the cleaning.
- Please complete the task within 15 minutes, in order to prevent the print heads from drying up.
- Then, the head cleaning will be performed to prevent any ink from drying up.

<TIPS>

- Pressing  causes the platen to start moving. Do not put anything around the platen.

- (3) Unlock and open the right-hand-side cover.

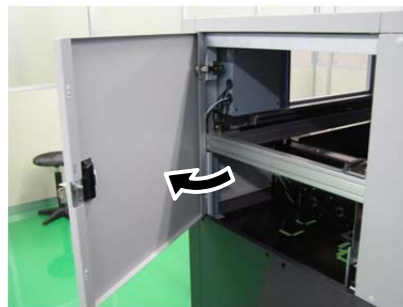



- (4) Put a proper amount of cleaning solution into the cleaning cup.
- (5) Moisten a clean stick R with the cleaning solution.

<IMPORTANT>

- Be sure to use a different clean stick R separately for the color head and the white head. Use a new clean stick R when you start cleaning.
- Do not use other fluids (water, etc.), because they may damage the print heads.
- Do not return the cleaning solution which has been put in the cleaning cup to the cleaning solution bottle.
- Do not shed cleaning solution in the maintenance unit.

<NOTE>

- For a proper work operation, be sure to wear the printer-provided gloves.

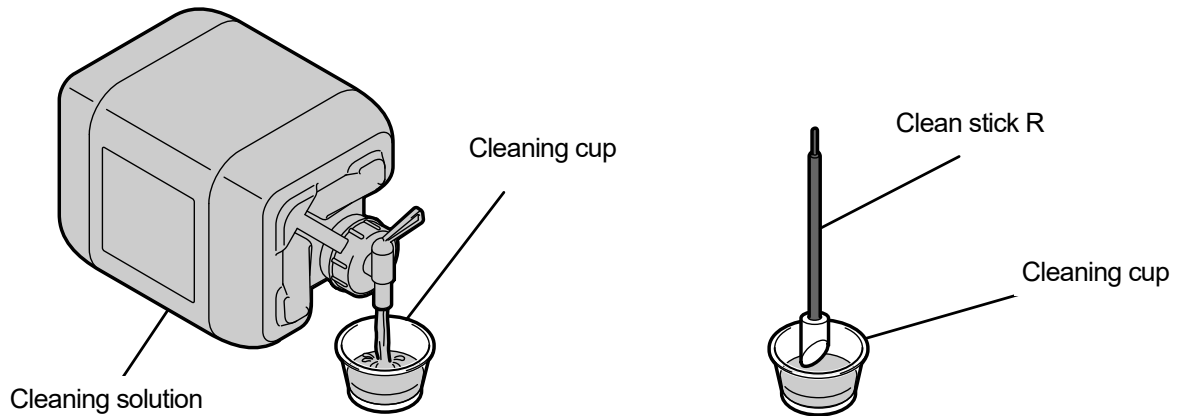

X1000

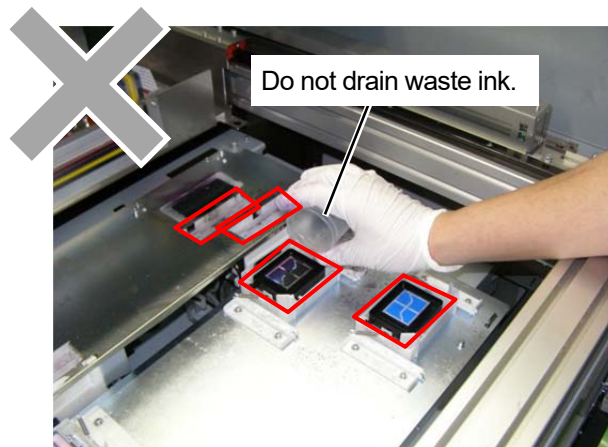

(6) With a clean stick R, clean the surrounding area of nozzle surface of print head.

<IMPORTANT>

- Be sure not to bring the clean stick R into contact with the nozzle surface.
- The used clean stick R should be disposed of, and should not be reused.
- Do not rub the parts strongly, which may scrape the water repellent film.

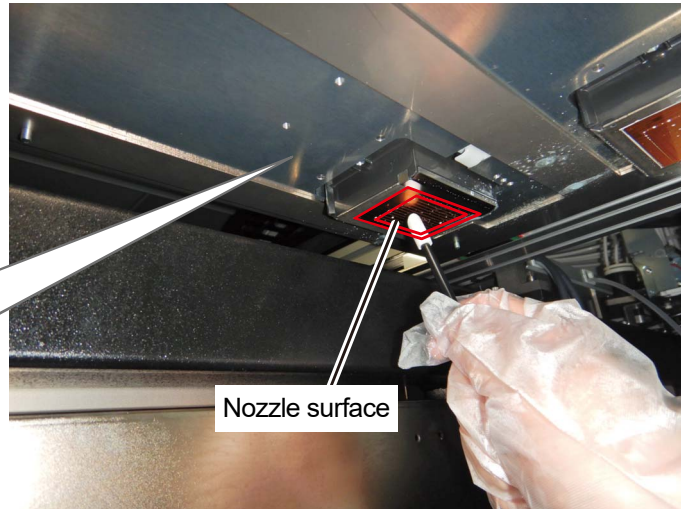

X1001

(7) Close the right-side cover and press  in response to the instructions on the screen.

<NOTE>

- Dispose of any waste resulting from the cleaning in accordance with applicable laws and ordinances.

<TIPS>

- Then, the head cleaning will be performed to prevent any ink from drying up.
- Because the cleaning cup will be reused, rinse it in clean cleaning solution and store it in a safe place.

Cleaning conditions

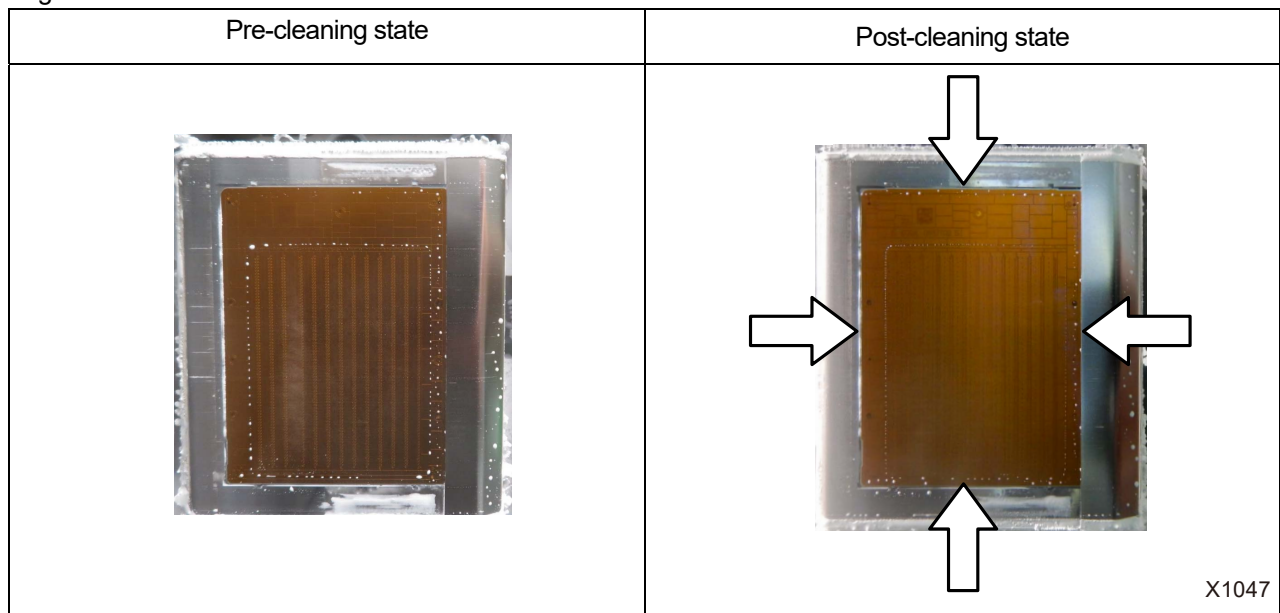

X1047

## 6-2-4. Disposal of waste ink and waste water

If a warning message appears on the operation panel screen or in the warning message window, dispose of the waste ink and the waste water in the tanks.

### <IMPORTANT>

- It takes about two years for the waste water tank to be filled up with water.  
When the waste ink tank accumulates, and an error occurs, treat the water in the waste water tank at the same time.

### <TIPS>

- Warning messages will be displayed for the respective tanks when the waste ink and the water in the waste water tank are about half full. However, these messages are not due to a malfunction of the detector.

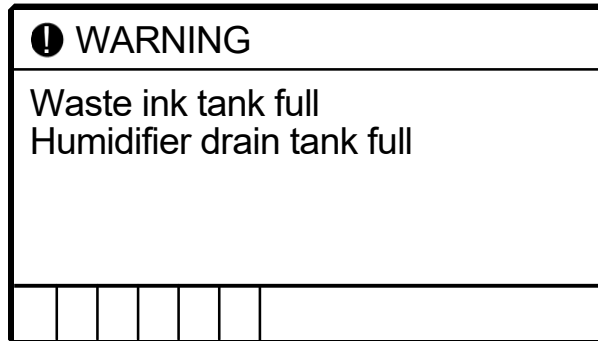

- From the menu, select [Maintenance] > [Empty/replace waste ink tank], and press



Follow the menu to complete the process.

- Open the lower left-hand-side cover.





- (3) Pull out the tube toward you from each tank and dispose of the waste ink and waste water in the tanks.  
Place a receiving tray or the like under the other end of the tube (when removed) from the waste ink tank so that the waste ink spilled from the tube will not be discharged onto the floor, etc.

<IMPORTANT>

- Waste ink tank and waste water tank can weigh as much as 10 kg (22 lb).  
Be careful when pulling them out.

<NOTE>

- Dispose of the waste ink properly as water-based waste fluid in accordance with applicable laws and ordinances.



- (4) Check the direction of the tank holes and install each tank as shown on the label.

Insert each tube into the tanks after installation.

<IMPORTANT>

- Be sure to push the tanks into the end.
- Install the tanks so that the hole of each tank is directly below the tube.  
The tanks may not be detected if the orientation is wrong.
- Make sure that the tubes are inside the respective tanks.
- Be careful not to bend the tubes excessively.  
Otherwise the waste ink may have difficulty flowing through the tube.

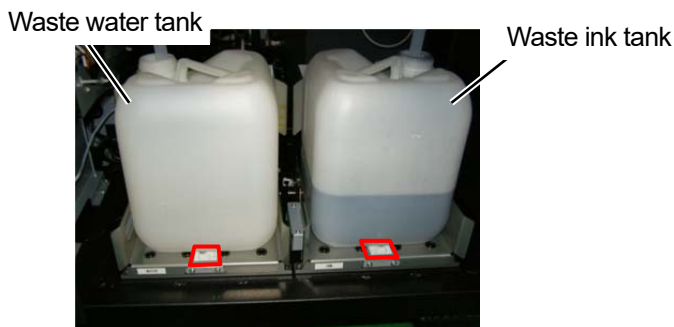

- (5) Close the lower left-hand-side cover.

### 6-3. When Not Using for a Long Period of Time

When the printer will not be used for a prolonged period of time, take appropriate procedures before storing the printer depending on storage period or condition.

#### <IMPORTANT>



- Do not turn the printer off. Otherwise, the printer may be damaged.
- If the power source to the printer cannot be sustained, please contact your dealer in advance.

#### <NOTE>

- If any error message is displayed on the screen, follow the instructions.
- When storing the printer for more than two weeks, clean the nozzle guard and suction cap.  "6-2-1. Cleaning the nozzle guard and suction cap >>P.6-46"





#### 6-3-1. When Not Using for a Long Period of Time: within 2 weeks

The printer can be used through normal procedure after the storage period, by performing the following maintenance tasks.

- (1) If the warning message window for the waste ink tank and waste water tank is displayed, dispose of the waste ink and the waste water in the tanks.  
 "6-2-4. Disposal of waste ink and waste water >>P.6-60"
- (2) Check the amount of cleaning solution in the cleaning solution tank, and refill the tank when its amount is below the proper level.  
 "6-1-3. Refilling the cleaning solution >>P.6-8"
- (3) As required, print out a nozzle check pattern.  
 "6-1-17. Print out the nozzle check pattern (checking on the print heads) >>P.6-44"

#### 6-3-2. When Not Using for a Long Period of Time: more than 2 weeks

Perform the following maintenance every two weeks.

- (1) If the warning message window for the waste ink tank and waste water tank is displayed, dispose of the waste ink and the waste water in the tanks.  
 "6-2-4. Disposal of waste ink and waste water >>P.6-60"
- (2) Check the amount of cleaning solution in the cleaning solution tank, and refill the tank when its amount is below the proper level.  
 "6-1-3. Refilling the cleaning solution >>P.6-8"
- (3) Print out a nozzle check pattern and verify the result.  
 "6-1-17. Print out the nozzle check pattern (checking on the print heads) >>P.6-44"
- (4) If a non-firing nozzle is found, perform head cleaning and run the nozzle check pattern print, and verify the result again.  
 "6-1-15. Head cleaning >>P.6-41"



As required, make settings and adjustments as mentioned below.

### About menu layer on the setting screen

Menu	Setting screen	Description
[Printer Setting]	[Print Direction]	[Auto]
		[Always Bi-Directional]
		[Always Uni-Directional]
	[Back Light]	[Light High]
		[Light Medium]
		[Light Low]
	[Auto Screen Erase Time]	[No Auto Screen Erase]
		[5 min]
		[10 min]
		[15 min]
	[Menu TimeOut Setting]	[30 min]
		[1min]
		[3min]
	[Speaker Volume]	[5 min]
		0 to 7
	[Temperature]	[Fahrenheit]
		[Centigrade]
	[Preview display settings]	[Display it upward]
		[Display it downward]
	[File name display setting]	[Priority to file name display]
		[Priority to job name display]
	[Platen Setting]	[Height settings by user]
		[Obstcl sensr setting during print]
		[Platen too low sensor]
	[Low Temperature Mode]	[Enable(Normal)]
		[Disable]
	[Low Humidity Mode]	[Printing at Low Humidity]
		[No Printing at Low Humidity]
		[Select Everyday]
	[Post-circulation Auto Cleaning]	[Before Next Printing]
		[Soon after if within 30 min.]
		[Soon after if within 1 hr.]
		[Soon after if within 90 min.]
	[Auto Cleaning Setting]	1 to 72
	[Auto Cleaning Start Timing]	[Conduct before Printing]
		[Conduct after Printing]
	[Auto Multiple Pass Setting]	[Always ON]
		[White Ink 6 cc or More]
		[White Ink 16 cc or More (Standard)]
		[White Ink 26 cc or More]
[Flushing Interval Setting]	[Always OFF]	
	[normal 42 lines]	
	[every 22 lines]	
[Flushing Volume Setting]	[every 6 lines]	
	[More]	
	[Standard]	

Menu	Setting screen	Description
[Printer Setting]	[Auto Job Delete]	[OFF]
		[ON]
	[Network filtering]	[Enable]
		[Disable]
	[IP Address Set]	[Automatic acquisition]
		[Manual setting]
	[Shortcut button setting]	[Normal Cleaning]
		[Auto cleaning]
		[Print Data Load]
		[White Ink Circulation]
	[Platen Height Adjustment]	
[Total Print]		
[Temperature/Humidity Info]		
[Confirm network setting]	[IP Address]	
	[Subnet Mask]	
	[Default Gateway]	
	[Host name]	
	[MAC address]	
[Check circulation schedule]		
[Check humidification schedule]		
[Language]	[English]	
	[Español]	
	[Français]	
	[Deutsch]	
	[Italiano]	
	[Türkçe]	
	[Русский]	
	[한국어]	
	[中文]	
[日本語]		
[Prepare Power OFF]		
[Version]	[Firm Version]	
	[Data Info]	
	[Serial No.]	
	[Head information]	

## 7-1. Setting the print direction



- (1) From the menu, select [Printer Setting] > [Print Direction], and press .
- (2) Select your desired print direction of the print heads, and press .

<TIPS>

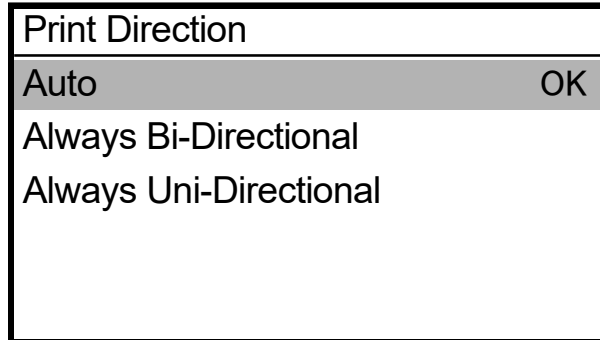
- The print direction is displayed here in the form of either bi-directional or the uni-directional icon .
- Note that the setting of the print direction gives priority to the printer's setting over the setting of the printer driver.
- The setting content will be kept intact until it is changed for the next printing job.



## 7-2. Screen back light adjustment



- (1) From the menu, select [Printer Setting] > [Back Light], and press .
- (2) Select your desired brightness of Liquid crystal panel, and press .

<TIPS>

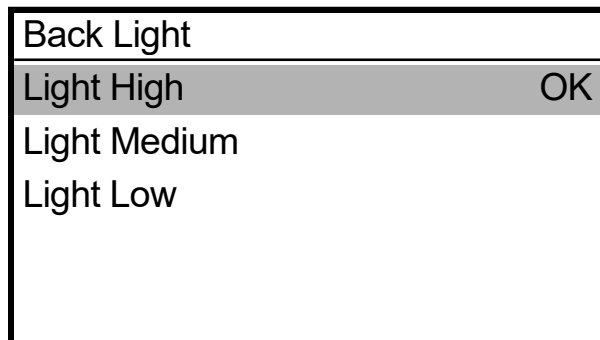
- During this menu selection process, the screen is displayed with the selected brightness.



### 7-3. Setup of Auto Screen Erase Time



- (1) From the menu, select [Printer Setting] > [Auto Screen Erase Time], and press .
- (2) Select your desired time until the liquid crystal panel and print button become unlit, and press .

<TIPS>

- During this menu selection process, the currently selected set value is displayed.

Auto Screen Erase Time	
No Auto Screen Erase	OK
5 min	
10 min	
15 min	
30 min	

### 7-4. Setting the menu timeout period



- (1) From the menu, select [Printer Setting] > [Menu TimeOut Setting], and press .
- (2) Select the time before the display screen returns to the standby mode screen, and press .

<TIPS>

- During this menu selection process, the currently selected set value is displayed.

Menu TimeOut Setting	
1 min	OK
3 min	
5 min	

## 7-5. Speaker volume setting



- (1) From the menu, select [Printer Setting] > [Speaker Volume], and press .
- (2) Adjust the speaker volume in an eight-step scale from 0 to 7, and press .

<TIPS>

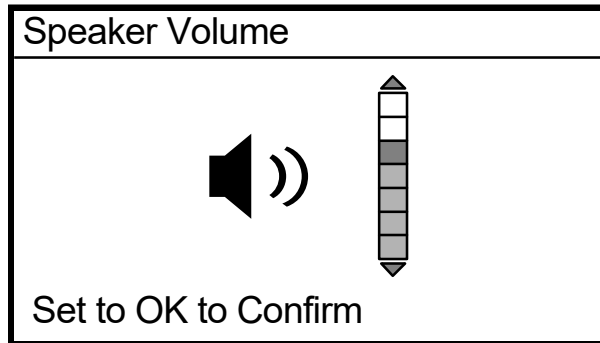
- You can adjust the volume while checking it.



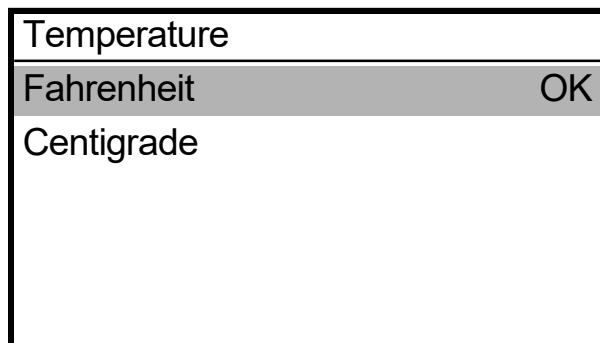

## 7-6. Setup of temperature indication

- (1) From the menu, select [Printer Setting] > [Temperature], and press .
- (2) Select your desired unit of ambient temperature to be shown on the liquid crystal panel, and press .



## 7-7. Preview display settings

Set the display direction of the preview image.

- (1) From the menu, select [Printer Setting] > [Preview display settings], and press .
- (2) Select the display direction and press .

### <TIPS>



- During this menu selection process, the currently selected set value is displayed.

Preview display settings	
Normal	OK
Inverted	

## 7-8. File name display setting

Make file name display settings of print data.

The display name you set is reflected in the selection screen of standby mode or receiving history or the USB flash memory loading screen.

- (1) From the menu, select [Printer Setting] > [File name display setting], and press .
- (2) Select the display method and press .

### <TIPS>

- The job name is set automatically by the image editing application.

File name display setting	
Priority to file name display	OK
Priority to job name display	



## 7-9. Platen Setting

### 7-9-1. User settings for height

There are custom positions that can be set to any height.

- (1) From the menu, select [Printer Setting] > [Platen settings] > [Height settings by user], and press .
- (2) Set the desired position.

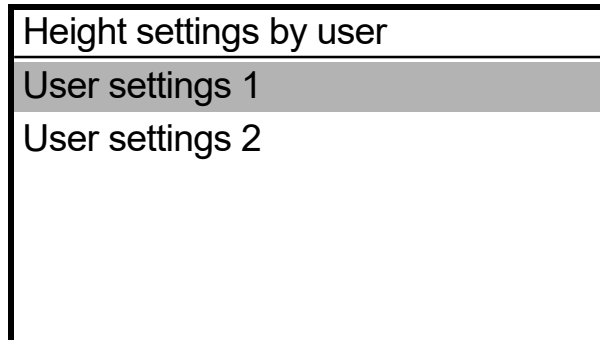

### 7-9-2. Configuring the obstacle sensor to work during the printing process

Specify the detection mode of the obstacle sensor by selecting either [Check when platen is loading] or [Check during printing as well].

- (3) From the menu, select [Printer Setting] > [Platen Setting] > [Obstcl sensr setting during print], and press .
- (4) Select the obstacle sensor setting and press .

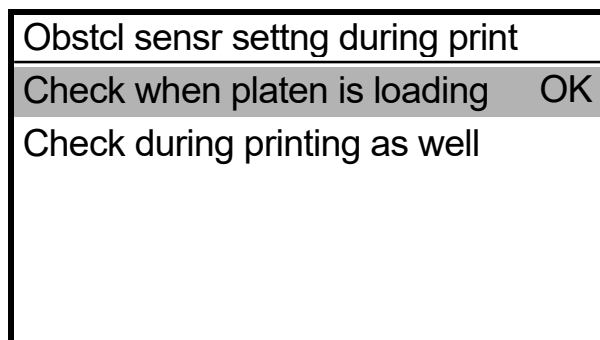

#### <TIPS>

- During this menu selection process, the currently selected set value is displayed.
- The obstacle sensor is intended to detect wrinkles of the print media or foreign object on it to prevent the print head from contacting wrinkles or foreign matter or minimize the time during which the contact continues.
- If the print head comes into contact with wrinkles or foreign object, a failure to eject ink-jet droplets or a mechanical failure may occur.
- If the obstacle sensor detects a foreign object, the printing process and the platen operation are immediately stopped.
- If you select [Check when platen is loading], the obstacle sensor works only while the platen is moving from the front to the rear.
- If you select [Check during printing as well], the obstacle sensor works during the period from when you press the print button to when the printing process completes.



### 7-9-3. Platen too low sensor setting

The sensor is activated if it detects that the print medium is far because the platen is too low.  
 Enable or disable this function when using the printer.

- (1) From the menu, select [Printer Setting] > [Platen Setting] > [Platen too low sensor], and press .
- (2) Select the "Platen too low" sensor function and press .

<TIPS>

- The "Platen too low" sensor checks if the platen is too low when it is completely inserted.
- If the "Platen too low" sensor is activated, the printing process and the platen operation are stopped.

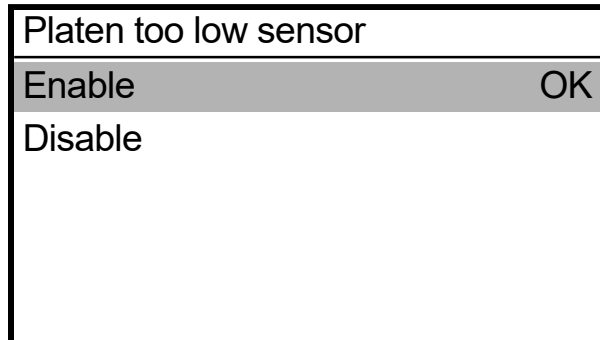



### 7-10. Print Operation Settings Under Low Temperature

Configure the printer with automatic switching to low temperature operation mode for ensuring print quality when [Temp Low] is displayed on the liquid crystal panel. It is set to [Enable(Normal)], by default.

If the low temperature operation mode is enabled, the printer will automatically be switched to the low temperature operation. Although it can assure print quality, it may take longer time for printing.

If the low temperature operation mode is disabled, print speed will not slow down; however, poor ejection may occur.

- (1) From the menu, select [Printer Setting] > [Low Temperature Mode], and press .
- (2) Select the print mode under low temperature and press .

<TIPS>

- When [Disable] is selected, white ink injection may become unstable when trying to print a wide area.

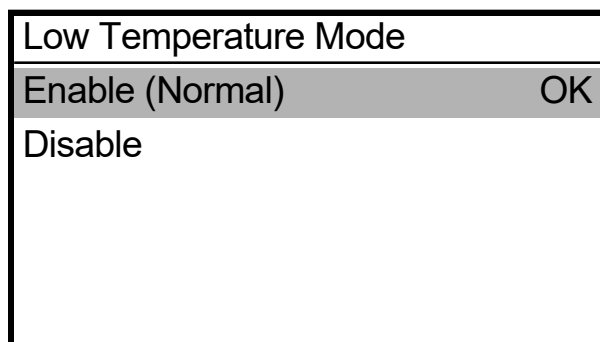

## 7-11. Print Operation Settings Under Low Humidity

- (1) From the menu, select [Printer Setting] > [Low Humidity Mode], and press .
- (2) Select the setup items and press .

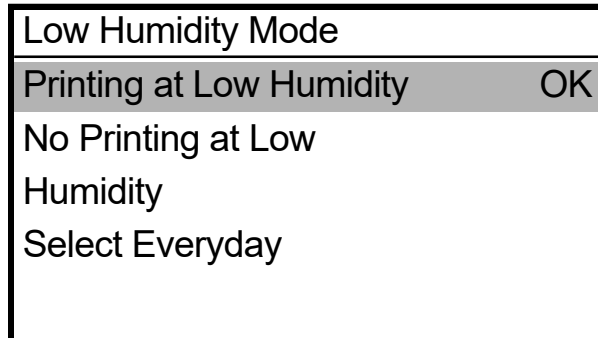

### <TIPS>

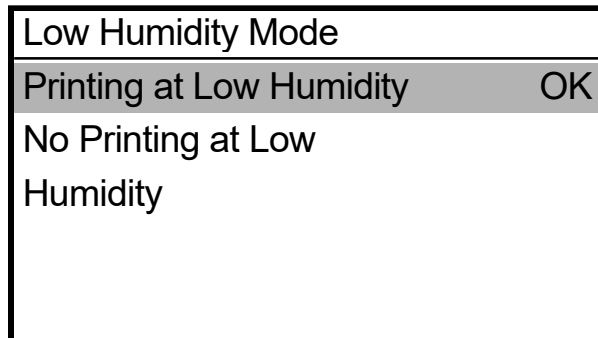

- You can print even in a low humidity environment if you select [Printing at Low Humidity]. However, the frequency of auto-cleaning and the amount of waste liquid will increase if you print in a low humidity environment.
- You cannot print in a low humidity environment if you select [No Printing at Low Humidity].
- The following confirmation screen will be displayed once a day at the first timing when you try to print in a low humidity environment if you select [Select Everyday].



## 7-12. Auto Cleaning Setting

### Post-circulation Auto Cleaning



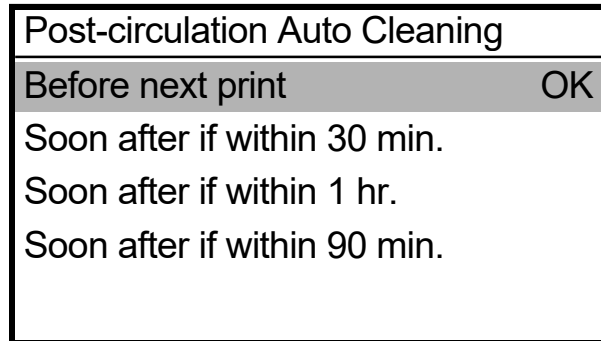

Specify your desired auto cleaning start timing after circulation.

- (1) From the menu, select [Printer Setting] > [Post-circulation Auto Cleaning], and press .
- (2) Select your desired post-circulation auto cleaning start timing, and press .



### Setting the Number of Printed Sheets for Auto Cleaning

Specify the number of printed sheets as the frequency of Auto Cleaning; where head cleaning is automatically performed every time a predetermined number of sheets are printed in order to protect the printer and provide stable printing quality. If the printing quality deteriorates in continuous printing, decrease the number of printed sheets for Auto Cleaning. The default value is 72.

- (1) From the menu, select [Printer Setting] > [Auto Cleaning Setting], and press .
- (2) Press  /  to set up the number of sheets to be printed in the range between 1 and 72, and press .

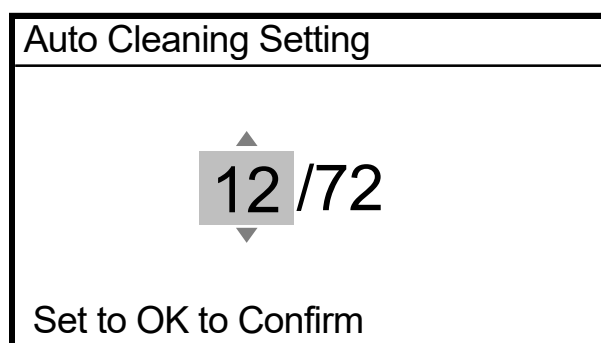

#### <TIPS>

- The printing quality tends to deteriorate if the humidity is low.
- If the auto cleaning is performed more frequently, the Wiper cleaner and flushing foam will need to be replaced with a new one earlier.



### Auto Cleaning Start Timing

Specify your desired auto cleaning start timing.

- (1) From the menu, select [Printer Setting] > [Auto Cleaning Start Timing], and press .
- (2) Select your desired auto cleaning start timing, and press .



<TIPS>

- Even when [Conduct after Printing] is selected, Auto Cleaning may be performed before printing, depending on the state of use.

Auto Cleaning Start Timing	
Conduct before Printing	OK
Conduct after Printing	

### 7-13. Setting Automatic Multiple Pass Settings

Perform this if the white printing quality deteriorates while printing.

- (1) From the menu, select [Printer Setting] > [Auto Multiple Pass Setting], and press .
- (2) Select the amount of white ink used for multiple pass printing and press .



<TIPS>

- The printing quality tends to deteriorate while printing if the temperature is low.
- Although automatic multiple pass printing can assure print quality, it may take a longer time for printing.

Auto Multiple Pass Setting	
Always ON	OK
White Ink 6 cc or More	
White Ink 16 cc or More (Standard)	
White Ink 26 cc or More	
Always OFF	

## 7-14. Flushing Interval Setting

Perform this if the printing quality deteriorates during printing operations.

- (1) From the menu, select [Printer Setting] > [Flushing Interval Setting], and press .
- (2) Select the desired number of scanning operations until the flushing starts, and press .

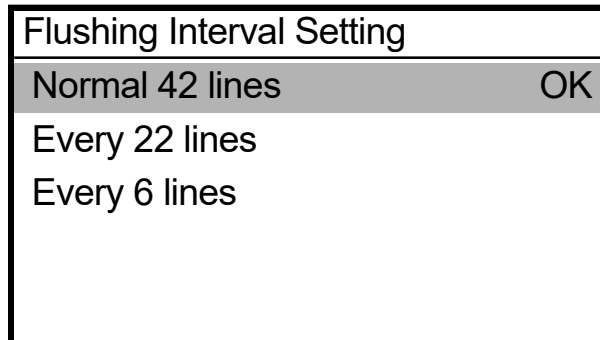

### <TIPS>

- The printing quality tends to deteriorate during the printing operation if the humidity is low.
- Setting shorter flushing intervals improves the printing quality, however, increases the ink consumption and increases the time required for printing.



## 7-15. Flushing Volume Setting

Perform this if the printing quality deteriorates at the startup of the printing operation.



- (1) From the menu, select [Printer Setting] > [Flushing Volume Setting], and press .
- (2) Select your desired volume of ink to be ejected from the print heads during the flushing operation before the printing operation starts, and press .

### <TIPS>

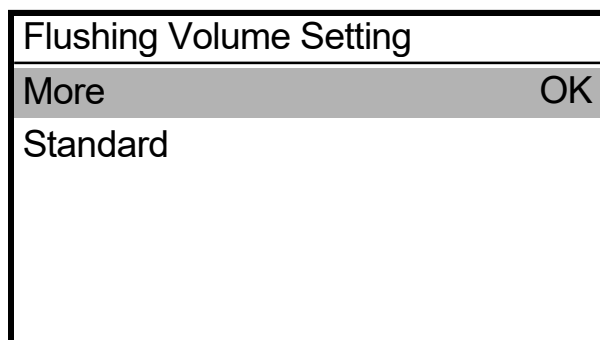
- The printing quality tends to deteriorate at the startup of the printing operation if the humidity is low.
- Setting larger flushing volume improves the printing quality, however, increases the ink consumption.





## 7-16. Automatic deletion of print data

- (1) From the menu, select [Printer Setting] > [Auto Job Delete], and press .
- (2) Select the desired function of Auto Job Delete, and press .

Auto Job Delete	
OFF	OK
ON	

## 7-17. Network filtering settings



This function will enhance LAN security. Enable or disable this function when using the printer. Setting this function to [Enable] will allow only specific PC access. It is set to [Disable], by default.

- (1) From the menu, select [Network filtering setting], and press .
- (2) Select either [Enable] or [Disable], and press .

Network filtering	
Enable	OK
Disable	

## 7-18. Static IP address setting

In the [IP Address Set] window, select the automatic acquisition or manual setting, and set up the [IP Address], [Subnet Mask] and [Default Gateway] when you select the manual setting.

- (1) From the menu, select [Printer Setting] > [IP Address Set], and press .
- (2) Select either [Automatic acquisition] or [Manual setting] and press .

<TIPS>

- If you select [Automatic acquisition], the screen will go back to the standby mode screen after the settings are automatically acquired.

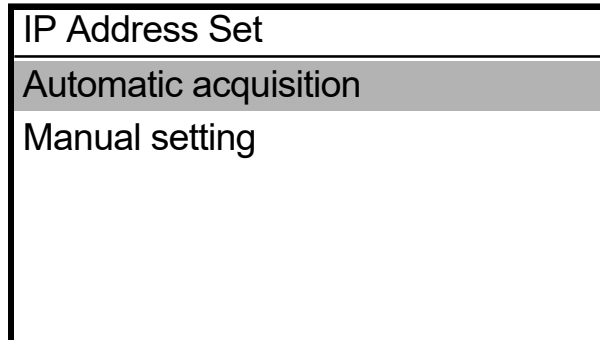

- (3) To make manual settings, press ◀ / ▶ to move to and select your desired position.
- (4) To make manual settings, press ▲ / ▼ to specify your desired numeric value.
- (5) When the  button is pressed, the selected value is accepted, and the display screen goes to the [IP Address], [Subnet Mask] and [Default Gateway] in sequence.

<TIPS>

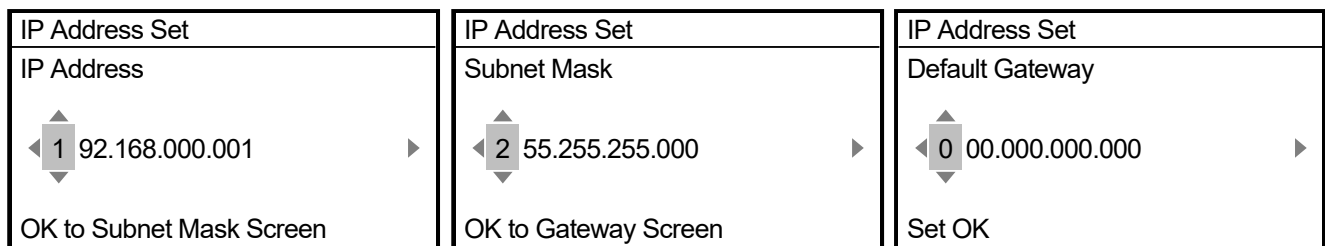

- The display screen shown here has been taken as an example.





## 7-19. Shortcut button setting

You can set the operation that takes place when the shortcut button on the operation panel is pressed.

- (1) From the menu, select [Printer Setting] > [Shortcut button setting], and press .
- (2) Select the function and press .

### <TIPS>

- During this menu selection process, the currently selected set value is displayed.
- If you select [Normal Cleaning], you will be presented with the Normal Cleaning Head Selection menu.
- If you select [Auto cleaning], Auto cleaning begins.
- If you select [Print Data Load], you will be presented with the screen to select the print data to load.
- If you select [White Ink Circulation], the white ink circulation begins.

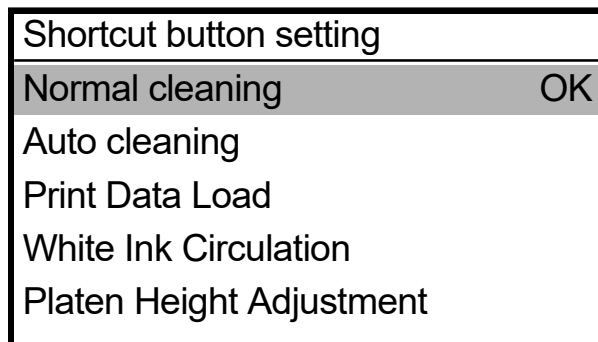

## 7-20. Display of total printed sheets

On this display screen, the total number of printed sheets is shown.

- (1) From the menu, select [Total Print], and press .
- (1) Then, the total number of printed sheets is displayed.

### <TIPS>

- Only the number of printed sheets of which printing has succeeded is counted, in which the canceled number of sheets is not included.
- All the printed sheets involved in printing operation, including test print, are counted.
- The display screen shown here has been taken as an example.
- The count of total number of printed sheets cannot be reset.

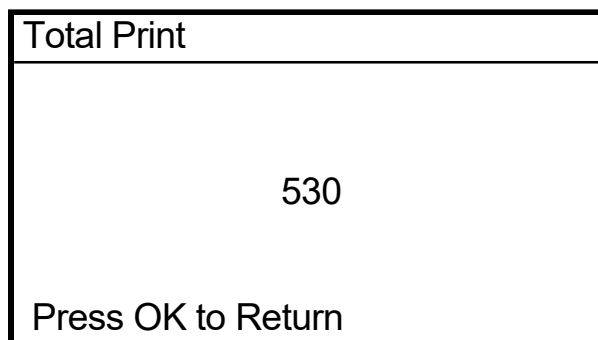

## 7-21. Display of Temperature/Humidity Info

Then, the ambient temperature and humidity are displayed.

- (1) From the menu, select [Temperature/Humidity Info], and press .
- (2) Then, the ambient temperature and humidity are displayed.



### <TIPS>

- Make the setting of temperature indication unit in the Temperature window.
- The display screen shown here has been taken as an example.

Temperature/Humidity Info		
Outer side	[24°C	(75°F)]
Right side	[42%	
Left side	[22°C	(72°F)]
Press OK to Return		

## 7-22. Confirm network setting

In the [Confirm network setting] window, display the [IP Address], [Subnet Mask], [Default Gateway], [Host name], and [MAC address].

- (1) From the menu, select [Confirm network setting], and press .
- (2) Select one out of the [IP Address], [Subnet Mask], [Default Gateway], [Host name], and [MAC address], and press .

Confirm network setting
IP Address
Subnet Mask
Default Gateway
Host name
MAC Address

- (3) Display [IP Address], [Subnet Mask], [Default Gateway], [Host name], or [MAC address].

<TIPS>

- The display screen shown here has been taken as an example.

IP Address
192.168.000.001
Press OK to Return

Subnet Mask
255.255.255.000
Press OK to Return

Default Gateway
000.000.000.000
Press OK to Return

Host name
GTX6-XXXXXX
Press OK to Return

MAC Address
00:1B:A9:FD:BC:27
Press OK to Return

### 7-23. Check circulation schedule

White ink circulation can be performed at a specified time.

- (1) From the menu, select [Check circulation schedule], and press .
- (2) Display the circulation schedule.

<TIPS>

- If the scheduled time of white ink circulation is not set with the maintenance tool, the circulation schedule will not be displayed.

Check circulation schedule	
Current time 17:44	
00:30 (Long)	03:00
07:00	12:30
18:30	23:00
--:--	--:--

### 7-24. Check humidification schedule

- (1) From the menu, select [Check humidification schedule] and press .
- (2) The day of the week, start time, and end time for humidification will be displayed.



<TIPS>

- If the scheduled time of humidification is not set with the maintenance tool, the humidification schedule will not be displayed.

Check humidification schedule	
Sun.	09:00 ~ 18:00
Mon.	09:00 ~ 18:00
Tue.	09:00 ~ 18:00
Wed.	09:00 ~ 18:00
Thu.	09:00 ~ 18:00

## 7-25. Language setting



Select your desired language to be shown on the liquid crystal panel.

- (1) From the menu, select [Language], and press .
- (2) Select your desired language in the [Language] window, and finalize your setting by pressing .
- (3) Follow the on-screen message, and turn off the power and on again.

Language	
English	OK
Español	
Français	
Deutsch	
Italiano	

## 7-26. Display of version

On this display screen, the firmware's version information, [Firm Version], as well as [Data Info], [Serial No.], and [Head information] are shown.

- (1) From the menu, select [Version], and press .
- (2) Select [Firm Version], [Data Info], [Serial No.], or [Head information] and press .

Version information
Firm Version
Data Info
Serial No.
Head information

- (3) Then, [Firm Version], [Data Info], [Serial No.], or [Head information] will appear.

<TIPS>

- Pressing the  button causes the currently displayed window to go back to the [Version] window.
- The display screen shown here has been taken as an example.

Firm Version
Main 0.42.9601
ACT 0.33.0000
LCD 0.33.0000
Head 0.31.0000/ 0.31.0000

Data Info
Message 0.19.0000
Font 1.00.0000
Test Print 0.00.0007

Serial No.
Serial No. ABCDEFG1
Hardware ID 1.0

Head information
W_A No:6CM1234 V.Rating: 11
W_B No:6CM1235 V.Rating: 9
C_A No:6CM1234 V.Rating: 11
C_B No:6CM1235 V.Rating: 9

## 7-26-1. Updating of firmware

When a new firmware is released, please update the firmware.

<TIPS>

- To check any release information of a new firmware, please visit the website of Brother Industries, Ltd.

- Download the firmware's updated data from the website of Brother Industries, Ltd.
- On the PC, from [All Programs] in the Start menu, select the "GTX-6 Firmware Update" from "Brother GTX-6 Tools".
- Specify the firmware's updated data (.bwf).

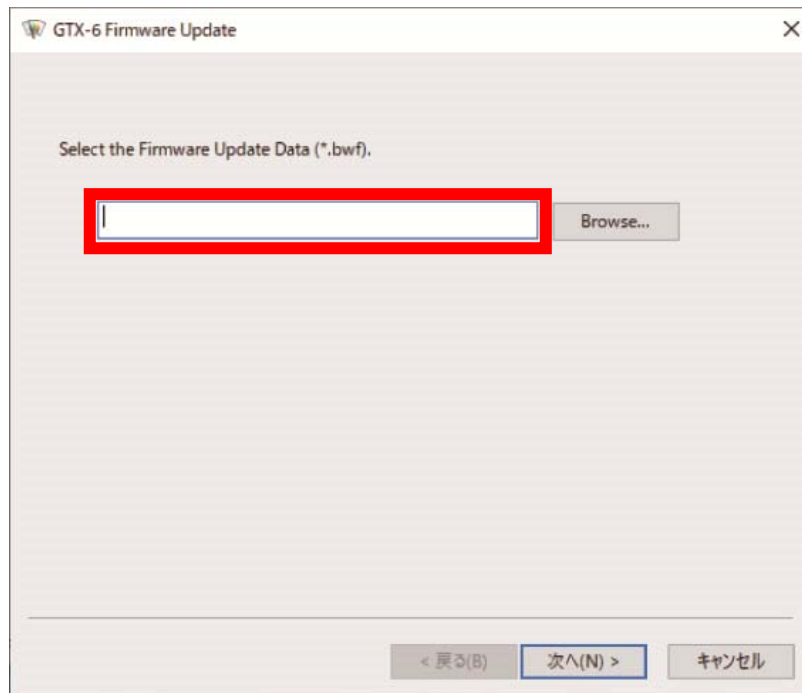

- Connect the PC to the printer via a LAN cable and update your firmware by performing the on-screen procedures.

**⚠ CAUTION**

Ensure there is adequate space left in front of the printer and avoid placing any objects. Otherwise your hand may get caught between the platen and an object, which may result in injury.



Do not handle the platen while printing. If your hand gets caught between the platen or the T-shirt tray and the covers, it may be injured.



Do not put your hands inside the covers while the printer's power is turned on. Otherwise your hands may touch against moving parts and this may result in injury.



Be careful not to pinch your fingers when closing each door and cover. You may get injured if you pinch your fingers.



When you mount or replace the head, be careful not to get your hands or fingers caught. Otherwise you may be injured.



Do not drink liquids such as the ink, maintenance solution, cleaning solution, pretreatment, or waste. They may cause diarrhea or vomiting.

When handling liquids, such as the ink, maintenance solution, cleaning solution, pretreatment, and waste ink, use protective glasses and gloves to avoid causing your eyes and skin to contact the liquids. It may cause inflammation. In case of contact with eyes, do not rub but immediately rinse the eyes with water.

Keep the liquids out of the reach of children.



Be sure to wear protective goggles and gloves when handling the grease, so that it does not get into your eyes or onto your skin.

It can cause inflammation. Do not drink or eat the grease. It may cause diarrhea or vomiting.

Keep the liquids out of the reach of children.



When replacing parts and installing optional accessories, be sure to use only genuine Brother parts. Brother will not be held responsible for any accidents or problems resulting from the use of non-genuine parts.



When replacing parts or installing optional accessories, be sure to follow the procedures described in the Instruction Manual. Incorrect procedures could cause injuries or problems.

**((!))IMPORTANT**

Do not move the platen by hand. Otherwise the printer may be mechanically and electrically damaged.



## 8-1. Troubleshooting instructions

With reference to the descriptions below, troubleshoot your problem.

### No print data can be sent from PC

Probable Cause	Remedy	Reference
Have you selected an incorrect printer or not?	From the menu for printing, check your printer name.	-
Has a LAN cable been connected properly?	Check the connection of the LAN cable (Category 5e or higher).	-
Are you using such PC or OS that is outside the specification?	Check your PC's operating environment.	"10-2. Software >>P.10-2"
Has any noise been produced between the printer and your PC?	Disconnect the LAN cable first and connect it again in five seconds. If the problem continues, power off the printer first, then reactivate it in five seconds.	-
Does your PC function properly?	Restart the PC.	-
Has any other USB device been connected to your PC?	Remove the other USB device, restart the PC, and check to see if the printer functions properly.	-
Has the LAN cable been damaged?	Use a different LAN cable.	-

### No printing job gets started even after pressing the print button

Probable Cause	Remedy	Reference
Are you pressing the print buttons properly?	Press and hold two print buttons at the same time.	-
Check if the print is scheduled (the button is flashing fast).	The print begins as soon as the printer becomes available. Wait for a while.	-
Is any error message displayed?	Eliminate the cause of the error, and perform printing once more.	"9. Error message >>P.9-1"
Does the menu screen still appear on the screen, or are you performing the maintenance operation from the menu?	Please exit the menu. Alternatively, please wait until the maintenance operation will come to an end.	-
Is the automatic head cleaning operation underway?	Please wait until the ongoing head cleaning operation is completed.	-
Is the printer in the white ink circulation stage?	Please wait until the ongoing white ink circulation is completed.	-
Is the room temperature suited to the usage conditions?	Check for your printer's operating environment and adjust the room temperature.	"10-1. Apparatus >>P.10-1"
Does the printer receive no print data, or is it in the state to receive such data (the print button is not illuminating)?	Send the print data to the printer. Alternatively, please wait until the reception of print data is completed.	-

Probable Cause	Remedy	Reference
Do you find that the temperature of print heads are becoming high, and [Color Head Getting Warm] or [W Head Temp Rising] message appears?	There may be the possibility that the flat cables of print heads have not been put in place and the temperature of print heads has become high. Turn off the power, make sure that the flat cable is in place, and wait until the temperature decreases.	-
Is the printer cover open?	Close the printer cover and try printing again.	-
Is the mist fan door open?	Close the mist fan door and try printing again.	"6-1-10. Replacing the mist fan filter >>P.6-28"
Is the mist fan filter set correctly?	Set the mist fan filter correctly and close the mist fan door. Then try printing.	"6-1-10. Replacing the mist fan filter >>P.6-28"

### The power cannot be turned on

Probable Cause	Remedy	Reference
Is the power cord connected to the printer?	Make sure that the power cord is connected to the printer.	-

### An error occurs immediately after activating the printer

Probable Cause	Remedy	Reference
Is any error message displayed?	Check the content of the error, and restart the printer. If the error is still not eliminated, please contact your dealer or Brother.	"9. Error message >>P.9-1"

### No print data can be loaded from USB flash memory

Probable Cause	Remedy	Reference
Is the applicable file ARP or AR3 file?	This printer cannot print out the print data of GT-541/GT-782/GT-3. Recreate the print data.	-

### Neither uni-directional printing nor bi-directional printing can be performed

Probable Cause	Remedy	Reference
Do the settings of printer driver and printer agree with each other?	Note that the setting of the printer's setting has priority over the setting of printer driver. The printer driver's setup value takes effect only if the printer's setting is [Auto].	"7-1. Setting the print direction >>P.7-3"

### The depletion of ink in an ink tank cannot be detected

Probable Cause	Remedy	Reference
Check if the remaining ink level correction was skipped or an incorrect value was entered for the correction.	Perform the remaining ink level correction again.	"6-1-4. Correcting the remaining ink level >>P.6-10"

**"x" is displayed for the remaining ink level after refilling ink.**

Probable Cause	Remedy	Reference
Is ink of a wrong color refilled?	Refill the right ink. If ink colors are mixed in the ink tank as the result of refilling ink of a wrong color, contact your dealer.	-

**The remaining volume indication of the ink tank does not reflect the actual status**

Probable Cause	Remedy	Reference
Check if the remaining ink level correction was skipped or an incorrect value was entered for the correction.	Perform the remaining ink level correction again.	"6-1-4. Correcting the remaining ink level >>P.6-10"

**Ink is leaking from the lower right side of the printer**

Probable Cause	Remedy	Reference
Is the degassing module not out of order?	For help, please contact your dealer.	-

**Water supply error**

Probable Cause	Remedy	Reference
Is a humidifier water supply error displayed?	<p>If a water supply error occurs, the humidifier will stop working. Perform [Humidification start] from the menu.</p> <p>Start humidification from the menu after confirming the following two points. If the problem persists, contact your dealer.</p> <p>①Make sure the water tank is filled with water.</p> <p>②Make sure that the main faucet of the water supply section (pure water equipment and tank) is open.</p>	-
Is a water supply shortage error or a water supply failure error displayed?	<p>If you are using a tap water supply, make sure that the main tap and water supply pressure are sufficient.</p> <p>If you are using a water tank, make sure the water tank is filled with water.</p> <p>Ascertain the water supply tube is not broken or crushed.</p> <p>Check if the installation height of the water supply tank is appropriate.</p>	"1-5. About the humidifier >>P.1-19"

**Initial humidifier operation failed.**

Probable Cause	Remedy	Reference
Initial humidifier operation failed?	<p>Perform initial humidifier operation from the menu after confirming the following two points. If the problem persists, contact your dealer.</p> <p>① Make sure that the amount of water in the tank and the installation height of the tank are appropriate.</p> <p>② Check if there are any problems with the piping from the water supply section (pure water equipment and tank), such as disconnected tubing or forgetting to open the main faucet. If you supply water from a tank, make sure it is a new tube.</p>	-

## How to resolve carriage errors 6130 and 6131

- (1) Unlock and open the right-side cover.

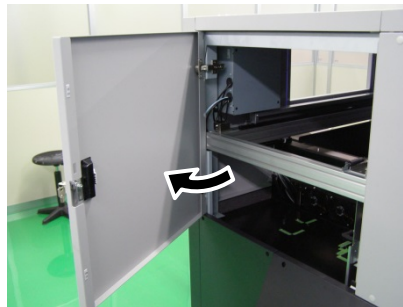

- (2) Loosen the two bolts on the carriage belt holder.



**<IMPORTANT>**

- Loosen the two bolts until there is a gap between each bolt's face and the part.

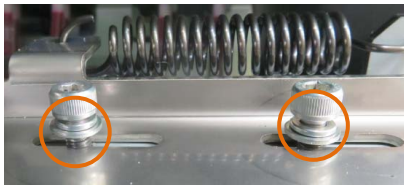

- (3) Tighten the two bolts on the carriage belt holder to 3.5 N-m.

- (4) Close and lock the right-side cover.

Contact your dealer if you have any questions.

## 8-2. Solutions to print quality problems

With reference to the descriptions below, troubleshoot your problem.

### Print is too light

Probable Cause	Remedy	Reference
Is the setting of an image editing software application made improperly, or is an image placed in CMYK mode?	Edit the image.	"4-3. Using other applications >>P.4-4"
Have the printing conditions been applied improperly, or does your image data have insufficient color saturation?	Using [Color Processing], adjust saturation or contrast as appropriate.	"4-4-10. Set up the image quality >>P.4-36" "4-5-6. Set up the image quality >>P.4-46"
Is there any nozzle that does not eject ink-jet droplets?	Perform [Head Cleaning] from the menu. If no improvement is attained, follow the referenced instructions.	"8-2-1. Recovery action to be taken for such a nozzle that is unable to eject ink-jet droplets >>P.8-13"
Is initial settings after head replacement configured?	Perform the initial settings after head replacement configuration.	"3-6-1. Initial settings after head replacement >>P.3-24"
Is the [Low Temperature Mode] set to [Disable]?	Change the setting to [Enable (Normal)].	"7-10. Print Operation Settings Under Low Temperature >>P.7-8"

### Horizontal stripe (banding) is found on printed material

Probable Cause	Remedy	Reference
Is there any nozzle that does not eject ink-jet droplets?	Perform [Head Cleaning] from the menu. If no improvement is attained, follow the referenced instructions.	"8-2-1. Recovery action to be taken for such a nozzle that is unable to eject ink-jet droplets >>P.8-13"
Do you print ink dots on a highly water-absorbing print medium?	Set the print head's print direction to [Always Uni-Directional]. Also, combine the color multiple pass printing with the printing.	"7-1. Setting the print direction >>P.7-3"
Is the platen positioned at a level that is too low?	Adjust the height of the platen corresponding to the print medium before using it. You can use the platen height adjustment lever from the menu to adjust the height of platen. As a rough indication, adjust the height so that it is lowered by one step from the limit height detected by the obstacle sensor, and check that the platen is not detected by the sensor.	"5-5. Placing print medium in position >>P.5-17"
Is the ejection timing correct?	Adjust the ejection timing again. It is likely that the setup value is incorrectly set after replacing a print head or the platen with a new one, or after adjusting the platen height.	"3-6-3. Firing adjustment >>P.3-26"
Check if the temperature is low.	Change the auto multiple pass settings.	"7-13. Setting Automatic Multiple Pass Settings >>P.7-11"
Is the [Low Temperature Mode] set to [Disable]?	Change the setting to [Enable (Normal)].	"7-10. Print Operation Settings Under Low Temperature >>P.7-8"

### Blurring is observed (when printed with [Color Ink Only])

Probable Cause	Remedy	Reference
Isn't the amount of ink excessive against the print media?	Print the ink volume and check the blurring, and select appropriate set value for [Ink Volume:].	"4-6-5. Adjust the ink volume >>P.4-52" "4-5-5. Set up the color ink >>P.4-44"

### Blurring is observed (when printed with [Color+White Ink])

Probable Cause	Remedy	Reference
Is the [Highlight:] of [White Ink Settings:] too high?	Print the highlight check pattern to check the blurring, and select appropriate set value for [Highlight:].	"4-6-6. Print out of highlight check pattern/mask check pattern >>P.4-53" "4-4-6. Set up the white ink >>P.4-28"
	By turning ON the [White/Color Pause] or [Color Multiple Pass Printing] checkbox, extend time before the color ink settles onto the white ink, to prevent blurring. Try this method to eliminate blurring without weakening the highlight.	"4-4-6. Set up the white ink >>P.4-28"

### Ink sticks to such an area where no print data exists (ink stain, horizontal stripe, etc.)

Probable Cause	Remedy	Reference
Is the area around the print heads soiled with waste ink spilled from the head cap?	Clean the head section and suction cap.	"6-2-1. Cleaning the nozzle guard and suction cap >>P.6-46"
Is any lint attached to the nozzle surface?	Clean the nozzle guard.	"6-2-1. Cleaning the nozzle guard and suction cap >>P.6-46"
Is the carriage foam contaminated?	Replace the carriage foam with a new one.	"6-1-9. Replacing the carriage foam >>P.6-20"
Do the print heads rub against a T-shirt?	Flatten the surface of T-shirt, and adjust the platen's height as required.	"5-5. Placing print medium in position >>P.5-17"
Has the flushing foam become dirty?	Replace the flushing foam with a new one.	"6-1-8. Replacing the flushing foam >>P.6-17"
Has the platen sheet become dirty?	Replace the platen sheet with a new one.	"6-1-11. Replacing the platen sheet >>P.6-30"
Has any ink attached to the carriage that secures the print heads in place or is it dripping off?	Replace the carriage foam with a new one.	"6-1-9. Replacing the carriage foam >>P.6-20"

**The edges of the image are blurred, characters and straight lines are doubly printed and printed result appears too granular**

Probable Cause	Remedy	Reference
Is the platen positioned at a level that is too low?	Adjust the height of the platen corresponding to the print medium before using it. You can use the platen height adjustment lever from the menu to adjust the height of platen. As a rough indication, adjust the height so that it is lowered by one step from the limit height detected by the obstacle sensor, and check that the platen is not detected by the sensor.	"5-5. Placing print medium in position >>P.5-17"
Is the ejection timing correct?	Adjust the ejection timing again. It is likely that the setup value is incorrectly set after replacing a print head or the platen with a new one, or after adjusting the platen height.	"3-6-3. Firing adjustment >>P.3-26"
Is the image enlarged on the printer setting screen?	When a low resolution image is enlarged on the printer setting screen, it may blur or angle the image. Pattern data should be enlarged on an image editing application, and its roughness should be checked.	-

**Thin color cannot be printed out well gradually**

Probable Cause	Remedy	Reference
Is the ambient atmosphere at a high temperature and very dry, which in turn tends to cause the nozzle surface to dry up?	Perform the flushing more frequently. In addition, increase the flushing volume.	"7-14. Flushing Interval Setting >>P.7-12" "7-15. Flushing Volume Setting >>P.7-12"

**White ink is not printed out evenly**

Probable Cause	Remedy	Reference
Has the pretreatment been applied unevenly?	Apply the recommended amount of pretreatment evenly to the target area.	"5-3-3. Application of pretreatment >>P.5-9"
Has the pretreatment caused any change in hardness or deformation of the pretreatment roller? (This applies to the case where the pretreatment roller is used.)	After the pretreatment roller is used, put it in a plastic bag or the like hermetically to prevent it from drying up, and keep it in a flat place in an upright position. Also, when it remains unused for two weeks or longer, wash it well with running water, and let it dry in a shaded area.	-
Is any water content attached to the pretreatment roller after the pretreatment is fixated?	Prevent water content from being attached to the roller after the pretreatment is fixated.	"5-3-4. Fixation of pretreatment >>P.5-12"
Is there any lint, yarn waste, dust, etc. that are attached to the surface of pretreatment roller? (This applies to the case where the pretreatment roller is used.)	Clean the surface of the pretreatment roller.	"5-3-3. Application of pretreatment >>P.5-9"



Probable Cause	Remedy	Reference
Did you shake the pretreatment after its dilution?	Shake the pretreatment sufficiently.	"5-3-2. Dilution of pretreatment >>P.5-7"
Is the [Low Temperature Mode] set to [Disable]?	Change the setting to [Enable (Normal)].	"7-10. Print Operation Settings Under Low Temperature >>P.7-8"
Has the pretreatment been fixated insufficiently?	Check on an actual temperature of the heat press and its pressure during the fixation stage. Always keeping the lower iron (where media is placed) of the heat press at heated temperature with a heating source may solve this problem.	"5-3-4. Fixation of pretreatment >>P.5-12"

### Whiteness of print result is insufficient

Probable Cause	Remedy	Reference
Has the pretreatment been applied insufficiently?	Apply a proper amount of pretreatment.	"5-3-3. Application of pretreatment >>P.5-9"
Has the pretreatment been fixated insufficiently?	Check on an actual temperature of the heat press and its pressure during the fixation stage.	"5-3-4. Fixation of pretreatment >>P.5-12"
Is there any nozzle that does not eject ink-jet droplets?	Perform [Head Cleaning] from the menu. If no improvement is attained, follow the referenced instructions.	"8-2-1. Recovery action to be taken for such a nozzle that is unable to eject ink-jet droplets >>P.8-13"
Is the white ink circulated insufficiently?	From the menu, select [Maintenance] > [White Ink Circulation] to circulate the white ink properly.	-
Is the [Low Temperature Mode] set to [Disable]?	Change the setting to [Enable (Normal)].	"7-10. Print Operation Settings Under Low Temperature >>P.7-8"
Is the dilution rate of the pretreatment correct?	Dilute the pretreatment appropriately.	"5-3-2. Dilution of pretreatment >>P.5-7"
Is the [Highlight:] of [White Ink Settings:] too low?	Print the highlight check pattern to check the blurring, and select appropriate set value for [Highlight:].	"4-6-6. Print out of highlight check pattern/mask check pattern >>P.4-53" "4-4-6. Set up the white ink >>P.4-28"

### Too much luster

Probable Cause	Remedy	Reference
Are you using Teflon-treated peel-off sheet for fixation?	Use a silicon coated peel off sheet when curing the ink to reduce the gloss.	-

### Too fuzzy

Probable Cause	Remedy	Reference
Did you touch the print media (T-shirt) just before printing?	Excessively touching the media (T-shirt) on the platen by trying to flatten the media before printing could cause fuzziness. Make sure not to touch the media surface too much after the pretreatment is fixated.	-

Probable Cause	Remedy	Reference
Does it take a long time before printing, after the pretreatment fixation?	Leaving the print media (T-shirt) after fixing the pretreatment may cause fuzziness, because the media would absorb water. Print the pretreatment fixated media as soon as possible.	-
Is the upper iron on the heat press contaminated during the pretreatment fixation process?	If the upper iron is contaminated, it could roughen the print media (T-shirt) surface by a heat press process, to cause fuzziness. Clean the upper iron of the heat press with a cloth. If the condition persists, try using a peel-off sheet during the pretreatment fixation process, to probably improve the condition.	-
Unevenly dried during the fixation process?	It may be solved by inserting a silicone foam between the heat press lower iron and a print media (T-shirt) during ink fixation.	-

### Background white ink spreads out when printed with [Color+White Ink]

Probable Cause	Remedy	Reference
[White/Color Alignment] misaligned?	Misalignment of white and color inks can occur when the media thickness or the platen height is changed. Adjust the platen height first for the actual media to be printed, and align the white and color inks positions.	"3-6-6. White/color alignment >>P.3-29"
Is the media easy to stretch when wet?	Print misalignment may occur between white and color inks when the media stretches when wet with white ink. Increasing [Choke Width:] can prohibit spreading of the background white ink.	"4-4-6. Set up the white ink >>P.4-28"

### Printed surface cracks after fixation

Probable Cause	Remedy	Reference
Isn't the print surface folded before fixation is completed?	Try not to touch the print surface until the fixation process is completed.	-

### The lower left side area of the printer's main unit is soiled with ink

Probable Cause	Remedy	Reference
Is the waste ink tube dismounted from the maintenance unit?	For help, please contact your dealer.	-
Is the waste ink tube clogged causing the waste ink to flow reversely?	Straighten the waste ink tube to remove the clog.	-

**The cleaning solution is leaked from the cleaning solution tank**

Probable Cause	Remedy	Reference
Is the main body of printer put aslant?	Place the printer horizontally. If the problem is still not remedied, please contact your dealer.	"3-1. Installation of printer >>P.3-2"

**Takes longer print time than before**

Probable Cause	Remedy	Reference
Is the ambient temperature under 18°C (64.4°F)?	Adjust the room temperature to 18°C (64.4°F) or more. If it is difficult to adjust the room temperature, set the operational configuration under low temperature to [Disable].	"7-10. Print Operation Settings Under Low Temperature >>P.7-8"
Is your printing under a low humidity environment?	Wait for the humidity inside the printer to reach 50% or higher.	-

## 8-2-1. Recovery action to be taken for such a nozzle that is unable to eject ink-jet droplets

Please verify the followings when any nozzle is not ejecting ink droplets.

Items to be checked	Description	Remedy	Document
Is the lip of the suction cap dirty?	If the lip of the suction cap is dirty, the suction cap may not be able to adhere to the print head, and ink may not be sucked.	Clean the suction cap	"6-2-1. Cleaning the nozzle guard and suction cap >>P.6-46"
Is ink accumulated in the nozzle guard?	The suction cap may not be in close contact with the print head and ink may not be sucked if the space between the nozzle guard and the nozzle is contaminated.	Nozzle guard Cleaning	"6-2-1. Cleaning the nozzle guard and suction cap >>P.6-46"
Is there any deposit of ink around the nozzle surface?	When the surrounding area of nozzle surface is contaminated, it could lead to ejection failure since the wiper cannot clean the nozzle surface properly. Or, it could reduce the adhesion between the nozzle and suction cap, thereby causing ink suction failure.	Cleaning the surrounding area of nozzle surface	"6-2-3. Cleaning the surrounding area of nozzle surface >>P.6-57"
Is the wiper contaminated?	The wiper may become dirty, and the nozzle surface may not be wiped cleanly if the wiper cleaning solution is not sufficiently filled in the wiper cleaning tank.	Introduction of wiper cleaning solution	From the menu, select [Maintenance] -> [Operate wiper cleaning tank] -> [Add cleaning solution].
Is the wiper cleaning solution contaminated?	The wiper may not be sufficiently cleaned and the nozzle surface may not be wiped cleanly if the wiper cleaning solution is dirty.	Replacement of wiper cleaning solution	From the menu, select [Maintenance] -> [Operate wiper cleaning tank] -> [Change cleaning solution].
Is there any indication of scar or deformation on the wiper?	If the wiper has any scar or deformation, the wiper cannot clean the nozzle surface.	Replace the wiper	"6-1-6. Replacing the wiper >>P.6-12"
Is the flushing foam installed correctly?	If the flushing foam is not placed appropriately with no rise, it may touch the nozzle surface to stop ejection from the nozzle.	Mount the flushing foam	"6-1-8. Replacing the flushing foam >>P.6-17"
Is the ink accumulated on the flushing foam?	If an ink accumulates on the flushing foam, the ink may touch the nozzle surface to prevent ink from ejecting.	Replace the flushing foam	"6-1-8. Replacing the flushing foam >>P.6-17"
Is the tube correctly connected to the head?	If they are loosely mated, it may allow air to enter into the head section during the head cleaning operation, to cause non-ejection condition of the nozzle.	Verify connection between the head and the tube	"6-1-12. Replacement of print head >>P.6-32"
Is the tube filled with ink?	If a large amount of air exists in the tube, that air will go into the head to cause non-ejection condition of the nozzle.	Bleed ink air in the tube	From the menu, select [Maintenance] > [Tube air bleed] and select the corresponding head and color.

After carrying out appropriate remedial measures listed above, make sure the non-firing nozzle has been recovered. If it has not, perform the steps 1 to 5 to recover the non-firing nozzle.

### Step 1: Print out a nozzle check pattern

- (5) Print out a nozzle check pattern (1st time). ☞"6-1-17. Print out the nozzle check pattern (checking on the print heads) >>P.6-44"
- (6) Check the result of the printed nozzle check pattern (1st time), and carry out the following procedures. ☞"6-1-17. Print out the nozzle check pattern (checking on the print heads) >>P.6-44"

<TIPS>

- Even if the white print result is weak, since the white ink is ejected on one same spot through multiple nozzles, a relatively large amount of ink volume will be used, and the firing problem of a single nozzle will not affect the print quality so much. Even in a condition with weak lines, the print is performed without a problem.

Existence or nonexistence of a nozzle that does not eject any ink-jet droplets	Recovery action
Such a nozzle does not exist that does not eject any ink-jet droplets	Contact your dealer if there is no non-ejection when printing the nozzle check pattern, but a large amount of non-ejection occurs during printing.
Such a nozzle exists that does not eject any ink-jet droplets	Proceed to Step 2.

### Step 2: Perform the head cleaning

- (1) Perform a normal cleaning. ☞"6-1-15. Head cleaning >>P.6-41"
- (2) Print out a nozzle check pattern (2nd time).
- (3) Check the result of the printed nozzle check pattern (2nd time), and carry out the following procedures.

Existence or nonexistence of a nozzle that does not eject any ink-jet droplets	Recovery action
Such a nozzle does not exist that does not eject any ink-jet droplets	Exit
Ten-or-less nozzles exist that do not eject any ink-jet droplets	Perform the normal cleaning once again. Subsequently, proceed to (4).
Ten-or-more nozzles exist that do not eject any ink-jet droplets	Perform the powerful cleaning. Subsequently, proceed to (4).
More than half of the nozzles do not eject any ink-jet droplets	Perform air bleeding in the tube. From the menu, select [Maintenance] > [Tube air bleed] and select the corresponding head and color.

- (4) Print out a nozzle check pattern (3rd time).
- (5) Check the result of the printed nozzle check pattern (3rd time), and carry out the following procedures.

Existence or nonexistence of a nozzle that does not eject any ink-jet droplets	Recovery action
Such a nozzle does not exist that does not eject any ink-jet droplets	Exit
Such a nozzle exists that does not eject any ink-jet droplets	Proceed to Step 3.

### Step 3: Check that no ink-jet droplets are ejected from the applicable nozzle

- (1) Check locations of the non-ejecting nozzles on the result of the printed nozzle check pattern (1st to 3rd time), and carry out the following procedures.

Comparison of non-ejection nozzle positions	Recovery action
The same nozzle always does not eject ink-jet droplets	Perform the super cleaning -> print out of nozzle check pattern for the third time in a row.
A different nozzle does not eject ink-jet droplets	Leave the printer as it is for about 30 minutes, and perform the normal cleaning -> print out of nozzle check pattern for the third time in a row.

- (2) Check a result of the resultant nozzle check patterns, and carry out the following procedures.

Existence or nonexistence of a nozzle that does not eject any ink-jet droplets	Recovery action
Such a nozzle does not exist that does not eject any ink-jet droplets	Exit
Such a nozzle exists that does not eject any ink-jet droplets	Proceed to Step 4.

### Step 4: Clean the nozzle surface

- (1) Clean the nozzle surface of the print heads.  
 (2) Make the clean stick R, cleaning cup, gloves and cleaning solution, which come standard with the printer, available for use.

<IMPORTANT>

- Use a new clean stick R when you start cleaning.
- Never touch the tip end of clean stick R with your hand. If any sebaceous matter is attached to the head nozzle, it may result in the printer malfunction.

- (3) From the menu, select [Maintenance] > [Maintenance Part Clean/Replace] > [Clean nozzle guard and cap], and press .

<IMPORTANT>

- If any other error or message is displayed on the operation panel or warning message window, follow the message to solve the problem, then perform the cleaning.
- Please complete the task within 15 minutes, in order to prevent the print heads from drying up.
- Then, the head cleaning will be performed to prevent any ink from drying up.

- (4) Unlock and open the right-hand-side cover.

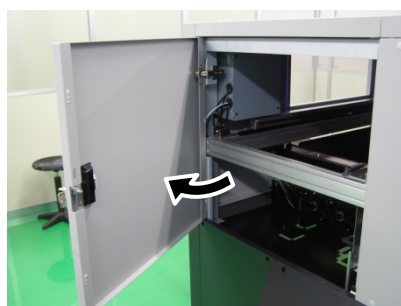

- (5) Put a proper amount of cleaning solution into the cleaning cup.
- (6) Moisten a clean stick R with the cleaning solution.

<IMPORTANT>

- Be sure to use a different clean stick R separately for the color head and the white head. Use a new clean stick R when you start cleaning.
- Do not use other fluids (water, etc.), because they may damage the print heads.
- Do not return the cleaning solution which has been put in the cleaning cup to the cleaning solution bottle.
- Do not shed cleaning solution in the maintenance unit.

<NOTE>

- For a proper work operation, be sure to wear the printer-provided gloves.

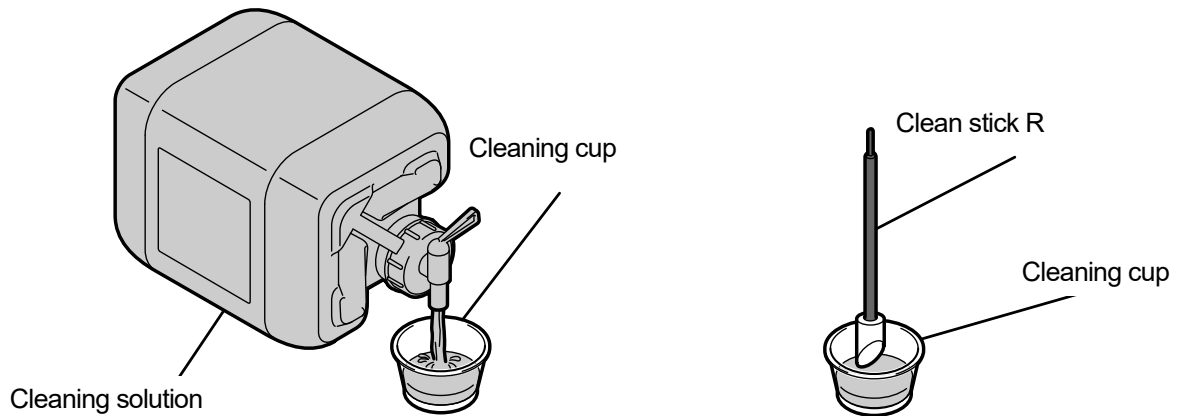

X1000

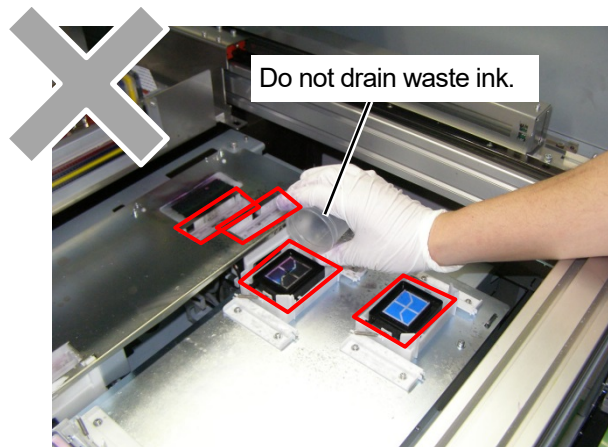



(7) With a clean stick R, clean the nozzle surface of print head.

<IMPORTANT>

- Be sure not to bring corner edges of the clean stick R into contact with the nozzle surface.
- Avoid roughly rubbing the nozzle surface.
- The used clean stick R should be disposed of, and should not be reused.

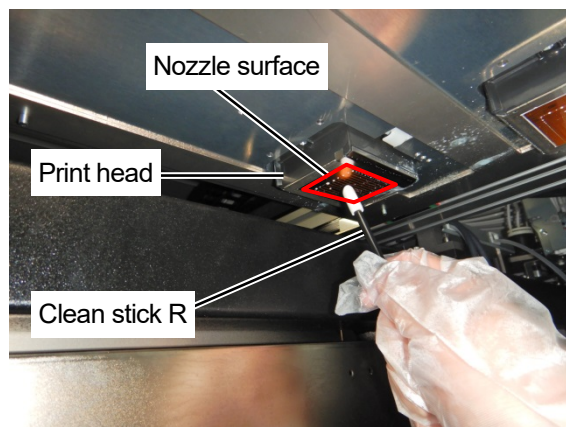

(8) Close the right-side cover and press  in response to the instructions on the screen.

<NOTE>

- Dispose of any waste resulting from the cleaning in accordance with applicable laws and ordinances.

<TIPS>

- Because the cleaning cup will be reused, rinse it in clean cleaning solution and store it in a safe place.

(9) Print out a nozzle check pattern.

(10) Check a result of the resultant nozzle check patterns, and carry out the following procedures.

Existence or nonexistence of a nozzle that does not eject any ink-jet droplets	Recovery action
Such a nozzle does not exist that does not eject any ink-jet droplets	Exit
Such a nozzle exists that does not eject any ink-jet droplets	Proceed to Step 5.

<IMPORTANT>

- Even if the nozzles on the white side have a bit of problem concerning firing, since the white ink is ejected on one same spot through multiple nozzles, relatively large amount of ink volume will be used, and firing problem of a single nozzle will not affect the print quality so much. Even in a condition with a problem concerning firing as shown in (a), print is performed without a problem as shown in (b).

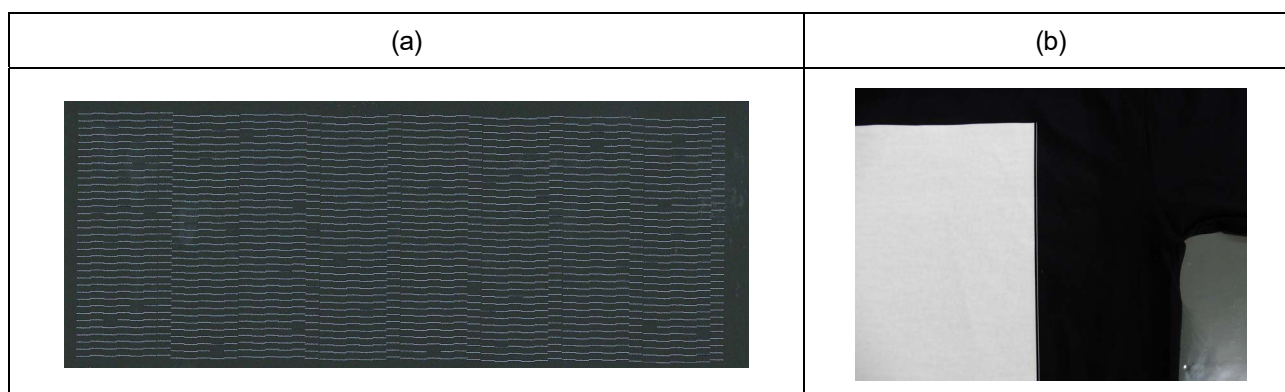



**Step 5: Head Replacement**

- (1) Replace the print head with a new one.  "6-1-12. Replacement of print head >>P.6-32"
- (2) If the non-ejection state persists after replacing the head, contact your dealer.





### 8-3. Acquisition of log file

In cases where the printer malfunctions, you may be required by our service personnel to obtain your printer's log file. For this reason, please save your printer's log file to a file.

<TIPS>

To the resultant file, such filename (.log) that automatically identifies your printer will be given.

#### Fetch a log file from USB flash memory

- (1) Insert a USB flash memory into the insertion slot of the printer.
- (2) Press  on the operation panel located on the left side of printer to go to the menu.
- (3) Press  / , select [Maintenance] > [Log copy to USB], and press .

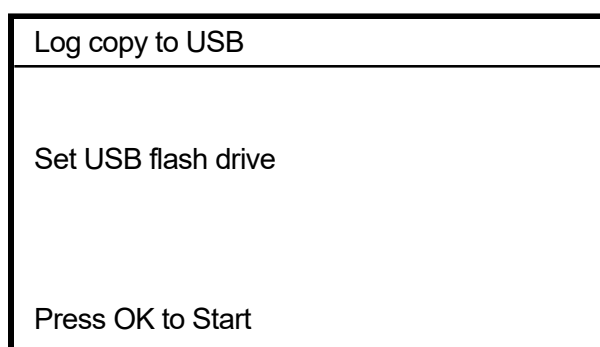

- (4) Then, the print button stops blinking, and the log file writing operation will be completed when you hear the sound of pong.

<IMPORTANT>

- Never remove the USB flash memory from the printer when the print button is blinking. Otherwise, the USB flash memory may be damaged, rendering its internal data to be unreadable.

- (5) Obtain the log file saved to the USB flash memory, and send such file to our service personnel.

## Fetch a log file via LAN connection

- (1) On the PC, from [All Programs] in the Start menu, select the "GTX-6 Maintenance" from "Brother GTX-6 Tools".
- (2) After the window shown below appears, select the [Log Data Retrieval] and click [Next].

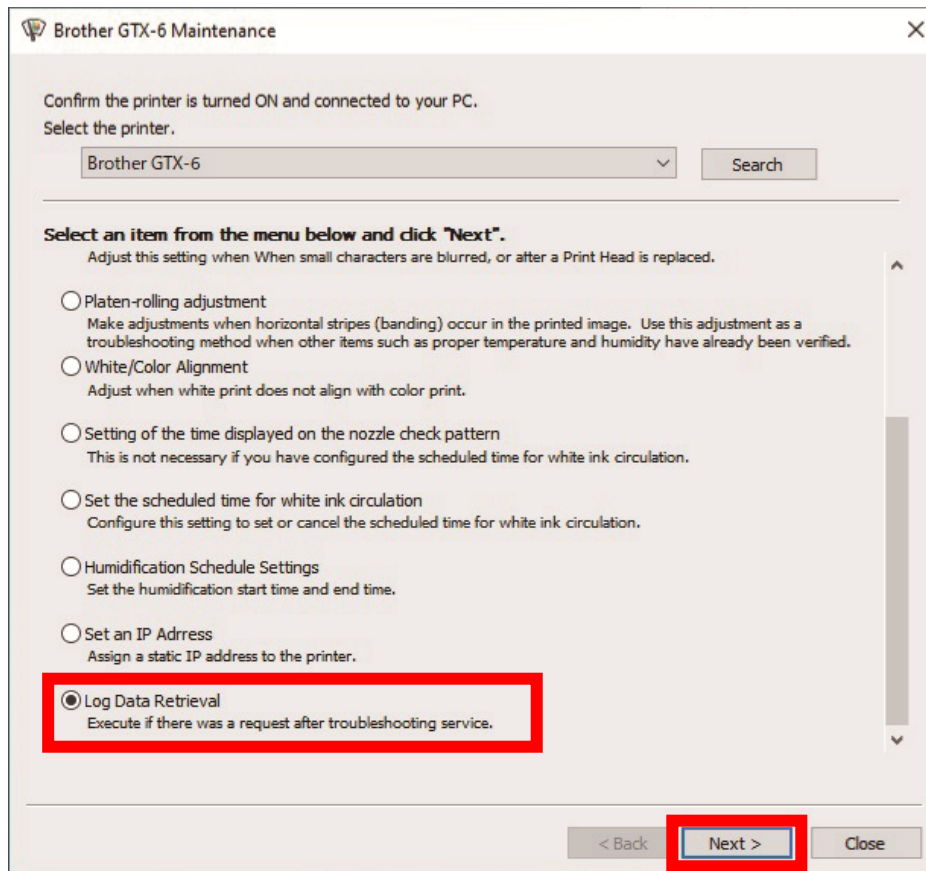

- (3) Perform the required operation by following the on-screen instructions in the dialog box.

## Error message

What is shown below is the error message list of the GTX-6 printer. Any error message is displayed on the liquid crystal panel.

Error code	Error message	Description	Remedy
0001	[I failed in initialization. Turn off and on]	No communication is established between the main board and panel board when the power is turned on. (Displayed in English regardless of the selected language.)	Check and see if any source produces a loud noise near the printer. If the problem persists even after reactivating the printer, please contact your dealer.
0011	[Machine Error]	No communication is established between the main board and color head board A when the power is turned on.	Check and see if any source produces a loud noise near the printer. If the problem persists even after reactivating the printer, please contact your dealer.
0012	[Machine Error]	No communication is established between the main board and color head board B when the power is turned on.	Check and see if any source produces a loud noise near the printer. If the problem persists even after reactivating the printer, please contact your dealer.
0013	[Machine Error]	No communication is established between the main board and white head board A when the power is turned on.	Check and see if any source produces a loud noise near the printer. If the problem persists even after reactivating the printer, please contact your dealer.
0014	[Machine Error]	No communication is established between the main board and white head board B when the power is turned on.	Check and see if any source produces a loud noise near the printer. If the problem persists even after reactivating the printer, please contact your dealer.
0021	[Machine Error]	No communication is established between the main board and actuator board 1 when the power is turned on.	Check and see if any source produces a loud noise near the printer. If the problem persists even after reactivating the printer, please contact your dealer.
0022	[Machine Error]	No communication is established between the main board and actuator board 2 when the power is turned on.	Check and see if any source produces a loud noise near the printer. If the problem persists even after reactivating the printer, please contact your dealer.
0023	[Machine Error]	No communication is established between the main board and actuator board 3 when the power is turned on.	Check and see if any source produces a loud noise near the printer. If the problem persists even after reactivating the printer, please contact your dealer.

Error code	Error message	Description	Remedy
0042	[Machine Error]	No communication is established between the main board and platen servomotor when the power is turned on.	Check and see if any source produces a loud noise near the printer. If the problem persists even after reactivating the printer, please contact your dealer.
0043	[Machine Error]	No communication is established between the main board and carriage servomotor when the power is turned on.	Check and see if any source produces a loud noise near the printer. If the problem persists even after reactivating the printer, please contact your dealer.
0044	[Machine Error]	No communication is established between the main board and white circulation solenoid board when the power is turned on.	Check and see if any source produces a loud noise near the printer. If the problem persists even after reactivating the printer, please contact your dealer.
0111	[Machine Error]	A communication error has occurred between the main board and color head board A while the printer is in operation.	Check and see if any source produces a loud noise near the printer. If the problem persists even after reactivating the printer, please contact your dealer.
0112	[Machine Error]	A communication error has occurred between the main board and color head board B while the printer is in operation.	Check and see if any source produces a loud noise near the printer. If the problem persists even after reactivating the printer, please contact your dealer.
0113	[Machine Error]	A communication error has occurred between the main board and white head board A while the printer is in operation.	Check and see if any source produces a loud noise near the printer. If the problem persists even after reactivating the printer, please contact your dealer.
0114	[Machine Error]	A communication error has occurred between the main board and white head board B while the printer is in operation.	Check and see if any source produces a loud noise near the printer. If the problem persists even after reactivating the printer, please contact your dealer.
0121	[Machine Error]	A communication error has occurred between the main board and actuator board 1 while the printer is in operation.	Check and see if any source produces a loud noise near the printer. If the problem persists even after reactivating the printer, please contact your dealer.
0122	[Machine Error]	A communication error has occurred between the main board and actuator board 2 while the printer is in operation.	Check and see if any source produces a loud noise near the printer. If the problem persists even after reactivating the printer, please contact your dealer.

Error code	Error message	Description	Remedy
0123	[Machine Error]	A communication error has occurred between the main board and actuator board 3 while the printer is in operation.	Check and see if any source produces a loud noise near the printer. If the problem persists even after reactivating the printer, please contact your dealer.
0131	[Machine Error]	A communication error has occurred in the hardware on actuator board 1 while the printer is in operation.	Check and see if any source produces a loud noise near the printer. If the problem persists even after reactivating the printer, please contact your dealer.
0132	[Machine Error]	A communication error has occurred in the hardware on actuator board 2 while the printer is in operation.	Check and see if any source produces a loud noise near the printer. If the problem persists even after reactivating the printer, please contact your dealer.
0133	[Machine Error]	A communication error has occurred in the hardware on actuator board 3 while the printer is in operation.	Check and see if any source produces a loud noise near the printer. If the problem persists even after reactivating the printer, please contact your dealer.
0141	[Machine Error]	A communication error has occurred between the main board and panel board while the printer is in operation.	Check and see if any source produces a loud noise near the printer. If the problem persists even after reactivating the printer, please contact your dealer.
0142	[Machine Error]	A communication error has occurred between the main board and platen servomotor while the printer is in operation.	Check and see if any source produces a loud noise near the printer. If the problem persists even after reactivating the printer, please contact your dealer.
0143	[Machine Error]	A communication error has occurred between the main board and carriage servomotor while the printer is in operation.	Check and see if any source produces a loud noise near the printer. If the problem persists even after reactivating the printer, please contact your dealer.
0144	[Machine Error]	A communication error has occurred between the main board and white circulation solenoid board while the printer is in operation.	Check and see if any source produces a loud noise near the printer. If the problem persists even after reactivating the printer, please contact your dealer.
1010	[Tank correction timing]	The main tank remaining volume sensor needs to be corrected.	Select [Correct tank volume sensor] menu item and correct the ink tank remaining volume sensor.
1011	[The tank needs corrections Execute correction]	The ink tank remaining volume sensor needs to be corrected.	Correct the ink tank remaining volume sensor following the instructions on the screen.
1031	[Color Head Getting Warm]	The temperature of color head A is rising.	Please wait until the temperature decreases. If the problem persists, please contact your dealer.
1032	[Color Head Getting Warm]	The temperature of color head B is rising.	Please wait until the temperature decreases. If the problem persists, please contact your dealer.

Error code	Error message	Description	Remedy
1033	[W Head Temp Rising]	The temperature of white head A is rising.	Please wait until the temperature decreases. If the problem persists, please contact your dealer.
1034	[W Head Temp Rising]	The temperature of white head B is rising.	Please wait until the temperature decreases. If the problem persists, please contact your dealer.
1060	[Temp Low]	The ambient temperature is lower than the scope covered by its warranty for the best print result.	Raise your room temperature.
1061	[Temp High]	The ambient temperature is higher than the scope covered by its warranty for the best print result.	Lower your room temperature.
1064	[Humidity too Low]	The humidity is lower than the scope covered by its warranty for the best print result.	Turn on the humidification function and wait for a while.
1065	[Humidity too High]	The humidity is higher than the scope covered by its warranty for the best print result.	Lower your room humidity.
1070	[Battery Needs to Be Replaced]	It is time to replace the battery on the main board.	Note the error code and error message, and notify your dealer.
1080	[Please Adjust RTC]	The built-in clock has not been set up.	Note the error code and error message, and notify your dealer.
1085	[Please Adjust RTC]	The built-in clock has not been set up.	Note the error code and error message, and notify your dealer.
1090	[Clean nozzle guard and cap]	The cap needs to be cleaned.	Select the [Clean nozzle guard and cap] menu item to perform cleaning.
1091	[Clean nozzle guard and cap]	The cap needs to be cleaned.	Select the [Clean nozzle guard and cap] menu item to perform cleaning.
1210	[Exhaust Fan Stop]	The mist collection fan (right side) is not working.	Note the error code and error message, and notify your dealer.
1211	[Exhaust Fan Stop]	The mist collection fan (left side) is not working.	Note the error code and error message, and notify your dealer.
1300	[Replace cap foam]	The cap foam needs to be replaced.	Select the [Replace maintenance unit parts] menu item and replace the cap foam.
1301	[Replace cap foam]	The cap foam needs to be replaced.	Select the [Replace maintenance unit parts] menu item and replace the cap foam.
1320	[Replace carriage foam]	The carriage foam needs to be replaced.	Select the [Replace maintenance unit parts] menu item and replace the carriage foam.
1321	[Replace carriage foam]	The carriage foam needs to be replaced.	Select the [Replace maintenance unit parts] menu item and replace the carriage foam.
1340	[Replace wiper]	The wiper needs to be replaced.	Select the [Replace maintenance unit parts] menu item and replace the wiper.
1341	[Replace wiper]	The wiper needs to be replaced.	Select the [Replace maintenance unit parts] menu item and replace the wiper.

Error code	Error message	Description	Remedy
1500	[Replace mist fan filter]	The mist fan filter needs to be replaced.	Select the [Replace mist fan filter] menu item and replace the mist fan filter.
1501	[Replace mist fan filter]	The mist fan filter needs to be replaced.	Select the [Replace mist fan filter] menu item and replace the mist fan filter.
1600	[Replace flushing foam]	The flushing foam needs to be replaced.	Select the [Replace maintenance unit parts] menu item and replace the flushing foam.
1601	[Replace flushing foam]	The flushing foam needs to be replaced.	Select the [Replace maintenance unit parts] menu item and replace the flushing foam.
1801	[None after head change]	Because color head A has been replaced, the Install Ink after Replacing Head function needs to be put into execution.	Select the [Install Ink after Replacing Head] menu item to install the ink for color head A.
1802	[None after head change]	Because color head B has been replaced, the Install Ink after Replacing Head function needs to be put into execution.	Select the [Install Ink after Replacing Head] menu item to install the ink for color head B.
1803	[None after head change]	Because white head A has been replaced, the Install Ink after Replacing Head function needs to be put into execution.	Select the [Install Ink after Replacing Head] menu item to install the ink for white head A.
1804	[None after head change]	Because white head B has been replaced, the Install Ink after Replacing Head function needs to be put into execution.	Select the [Install Ink after Replacing Head] menu item to install the ink for white head B.
1901	[Perform Initial Ink Installation]	Initial ink installation has not been performed yet.	Select the [Initial Ink Installation] menu item to implement initial ink installation.
1902	[Install initial ink (KYCM)]	Initial ink installation for the color heads has not been performed yet.	Install color ink using the [Initial Ink Installation] menu item and complete the process.
1903	[Install initial ink (W)]	Initial ink installation for the white head has not been performed yet.	Install white ink using the [Initial Ink Installation] menu item and complete the process.
1910	[Attach maintenance parts]	Maintenance unit parts are not installed.	Refer to the Setup Manual and use the [Replace maintenance unit parts] menu item to install wipers, flushing foam, carriage foam, etc.
1922	[Time for technical maintenance Contact service engineer]	Periodical maintenance and inspection are needed now.	For help, please contact your dealer.
1924	[Time for technical maintenance Contact service engineer]	Periodical maintenance and inspection are needed now.	For help, please contact your dealer.
1925	[Time for technical maintenance Contact service engineer]	Periodical maintenance and inspection are needed now.	For help, please contact your dealer.



Error code	Error message	Description	Remedy
1926	[Time for technical maintenance Contact service engineer]	Periodical maintenance and inspection are needed now.	For help, please contact your dealer.
2010	[Please Replace Black Ink Pouch]	The remaining black ink volume is below the specified amount.	Refill the black ink.
2011	[Please Replace Magenta Ink Pouch]	The remaining magenta ink volume is below the specified amount.	Refill the magenta ink.
2012	[Please Replace Cyan Ink Pouch]	The remaining cyan ink volume is below the specified amount.	Refill the cyan ink.
2013	[Please Replace Yellow Ink Pouch]	The remaining yellow ink volume is below the specified amount.	Refill the yellow ink.
2014	[Please Replace White Ink Pouch]	The remaining white ink volume is below the specified amount.	Refill the white ink.
2015	[Cleaning Solution Out - Add More]	The remaining cleaning solution volume is below the specified amount.	Refill cleaning solution.
2050	[Temp Low]	The ambient temperature decreases below the operation assurance range for the best print result.	Raise your room temperature.
2051	[Temp High]	The ambient temperature rises above the operation assurance range for the best print result.	Lower your room temperature.
2055	[Humidity too Low]	The humidity is lower than the operation assurance range for the best print result.	Turn on the humidification function and wait for a while.
2056	[Humidity too High]	The humidity is higher than the operation assurance range for the best print result.	Lower your room humidity.
2070	[Obstacle Sensed on the Platen]	The obstacle sensor has detected some obstacle on the platen or print medium.	Remove such obstacle from the platen, flatten its surface, and press the OK button to clear the error.
2071	[Obstacle detected during print]	The obstacle sensor has detected some obstacle on the platen or print medium while printing.	Remove such obstacle from the platen, flatten its surface, and press the OK button to clear the error. Perform test printing and check the ejection from the head for any abnormalities. If the ejection is abnormal, immediately perform head cleaning to rectify the abnormality.
2072	[Platen is too low Adjust the position]	The platen has been detected to be too low when attempting to start printing.	The gap between the medium's print surface and the print head is too large. Make adjustments by raising the platen.

Error code	Error message	Description	Remedy
2100	[USB flash drive Not Ready]	No USB flash memory has been inserted into its insertion slot.	Insert a USB flash memory into the slot, wait for a couple of seconds, and perform the operation. Insert a USB flash memory into the slot again. If the problem persists, check on the format and type of the USB flash memory.
2101	[Not Enough Area]	Writing is not possible because there is not enough free space in the USB flash memory.	Use your PC to check free space on the USB flash memory. Insert the USB flash memory that has enough free space into the slot.
2102	— (Log only)	The USB flash drive cannot be recognized.	If the problem persists even after reactivating the printer, please contact your dealer.
2105	[No Files Detected]	No target file exists in a USB flash memory.	Connect the USB flash memory to your PC for checking the information stored in it. If you have a saved file (ARX6 file or ARXP file or ARX4 file) in the USB flash memory, check the contents of the USB flash memory with a file viewer.
2110	[Receiving History W/O Error1]	There has been no receiving history since the power was turned on.	Press the OK button to clear the error.
2120	[Activate Print Data Auto Delete]	Because the Print Data Auto Delete Enable function remains active, no receiving history menu is available.	Press the OK button to clear the error. When you use the receiving history, disable the Print Data Auto Delete option.
2230	[Detected refilling of ink tank]	Black ink was refilled to the main tank in an incorrect way.	Refill the ink following the on-screen instructions. To refill the ink, be sure to select the [Ink refill] menu item.
2231	[Detected refilling of ink tank]	Magenta ink was refilled to the main tank in an incorrect way.	Refill the ink following the on-screen instructions. To refill the ink, be sure to select the [Ink refill] menu item.
2232	[Detected refilling of ink tank]	Cyan ink was refilled to the main tank in an incorrect way.	Refill the ink following the on-screen instructions. To refill the ink, be sure to select the [Ink refill] menu item.
2233	[Detected refilling of ink tank]	Yellow ink was refilled to the main tank in an incorrect way.	Refill the ink following the on-screen instructions. To refill the ink, be sure to select the [Ink refill] menu item.
2234	[Detected refilling of ink tank]	White ink was refilled to the main tank in an incorrect way.	Refill the ink following the on-screen instructions. To refill the ink, be sure to select the [Ink refill] menu item.
2235	[Detected refilling of ink tank]	Cleaning solution was refilled to the main tank in an incorrect way.	Refill the ink following the on-screen instructions. To refill the ink, be sure to select the [Ink refill] menu item.

Error code	Error message	Description	Remedy
2300	[Special work mode]	Under the operation by the service engineer	If the problem persists even after reactivating the printer, please contact your dealer.
2330	[Power was off for long time Executing recovery operation]	The power has been turned off for a long time and a recovery operation is required.	Follow the on-screen instructions and click the OK button to execute the recovery sequence. The recovery sequence depends on the length of time the printer is left turned off.
2335	[Long Power—OFF Detection]	A state in which no recovery operation has been executed since the power was turned off for a long time.	Follow the on-screen instructions and click the OK button to execute the recovery sequence. The recovery sequence depends on the length of time the printer is left turned off.
2340	[Waste ink tank full]	The waste ink tank is full.	Empty the waste ink tank.
2341	[Waste ink tank full]	The waste ink tank will be full soon.	Empty the waste ink tank.
2342	[Waste ink tank not in position]	The waste ink tank is not installed.	Install the waste ink tank.
2345	[Right door open]	The right door is open.	Close the right door.
2346	[Left door open]	The left door is open.	Close the left door.
2347	[Upper door open]	The upper door is open.	Close the upper door.
2350	[Right mist fan door open]	The mist fan door on the right side is open.	Close the mist fan door on the right side.
2351	[Left mist fan door open]	The mist fan door on the left side is open.	Close the mist fan door on the left side.
3000	[PC Communication Error]	Data reception from the PC has been suspended.	Make sure that your PC is connected to the printer, and resend the print data. If you have trouble, restart your PC and the printer. This error will also occur "when the cable is removed during data reception" or "when the ongoing operation is canceled on the PC during data reception".
3001	[PC Communication Error]	Data transmission to the PC has been suspended.	Make sure that your PC is connected to the printer, and start operating the PC tool over from the beginning. If you have trouble, restart your PC and the printer. This error may also occur "when the cable is removed during data transmission" or "when the PC tool is caused to stop running on the PC during data transmission".
3002	[PC Data Error]	Abnormal data has been received from the PC.	Make sure that your PC is connected to the printer, and resend the print data. If you have trouble, restart your PC and the printer.
3003	[PC Data Error]	Unsupported data has been received from the PC.	Update both the printer driver installed on the PC and the firmware of the printer to the latest version.

Error code	Error message	Description	Remedy
3004	[PC Data Error]	A communication error between the PC and printer.	Ascertain whether the updated data of firmware you try to send is correct or not. Make sure that your PC is connected to the printer, and start communication between your PC and the printer once again. If the problem is still not remedied, restart your PC and the printer. If the problem persists, please contact your dealer.
3005	[PC Data Error]	A communication error between the PC and printer.	Ascertain whether the updated data of firmware you try to send is correct or not. Make sure that your PC is connected to the printer, and start communication between your PC and the printer once again. If the problem is still not remedied, restart your PC and the printer. If the problem persists, please contact your dealer.
3010	[PC Data Error]	A communication error between the PC and printer.	Make sure that your PC is connected to the printer, and start communication between your PC and the printer once again. If the problem is still not remedied, restart your PC and the printer. If the problem persists, please contact your dealer.
3013	[PC Data Error]	A communication error between the PC and printer.	Make sure that your PC is connected to the printer, and start communication between your PC and the printer once again. If the problem is still not remedied, restart your PC and the printer. If the problem persists, please contact your dealer.
3014	[PC Data Error]	A communication error between the PC and printer.	Make sure that your PC is connected to the printer, and start communication between your PC and the printer once again. If the problem is still not remedied, restart your PC and the printer. If the problem persists, please contact your dealer.
3015	[Can no longer receive data]	Too much print data has been sent from the PC during the print operation.	Number of the print data sent from the PC during any print operation should be up to 99.
3400	[PC Data Error]	Abnormal data has been received from the PC.	Check on the ARX6 file by means of "GTX-6 File Viewer". Create the print data once again. If the problem persists, please contact your dealer.

Error code	Error message	Description	Remedy
3401	[PC Data Error]	Abnormal data has been received from the PC.	Check on the ARX6 file by means of "GTX-6 File Viewer". Create the print data once again. If the problem persists, please contact your dealer.
3402	[PC Data Error]	Abnormal data has been received from the PC.	Check on the ARX6 file by means of "GTX-6 File Viewer". Create the print data once again. If the problem persists, please contact your dealer.
3407	[No Data in Print File]	Print data with no images contained has been received from the PC.	Check on the ARX6 file by means of "GTX-6 File Viewer". For example, please confirm the print range and paper size for your software application through the Print Preview function, etc. of Photoshop.
3408	[PC Data Error (too large)]	Abnormal data has been received from the PC.	Note the error code and error message, and notify your dealer.
3410	[PC Data Error]	Abnormal data has been received from the PC.	Check on the ARX6 file by means of "GTX-6 File Viewer". Make sure that your PC is connected to the printer, and start communication between your PC and the printer once again. Restart your PC and the printer. If the problem persists, please contact your dealer.
3411	[PC Data Error]	Abnormal data has been received from the PC.	Check on the ARX6 file by means of "GTX-6 File Viewer". Make sure that your PC is connected to the printer, and start communication between your PC and the printer once again. Restart your PC and the printer. If the problem persists, please contact your dealer.
3412	[PC Data Error]	Abnormal data has been received from the PC.	Check on the ARX6 file by means of "GTX-6 File Viewer". Make sure that your PC is connected to the printer, and start communication between your PC and the printer once again. Restart your PC and the printer. If the problem persists, please contact your dealer.
4100	[USB flash drive Access Error]	The file in the USB flash memory is not accessible.	Check on the content of USB flash memory. Insert a USB flash memory into the slot again, and perform the required operation once more. If the problem is still not remedied, restart the printer and try to operate it once again.

Error code	Error message	Description	Remedy
4101	[USB flash drive Access Error]	File creation is not possible in USB flash memory.	Check on the content of USB flash memory. Insert a USB flash memory into the slot again, and perform the required operation once more. If the problem is still not remedied, restart the printer and try to operate it once again.
4103	[USB flash drive Access Error]	The file in the USB flash memory is not accessible.	Check on the content of USB flash memory. Insert a USB flash memory into the slot again, and perform the required operation once more. If the problem is still not remedied, restart the printer and try to operate it once again.
4104	[USB flash drive Access Error]	The file in the USB flash memory is not readable.	Check on the content of USB flash memory. Insert a USB flash memory into the slot again, and perform the required operation once more. If the problem is still not remedied, restart the printer and try to operate it once again.
4105	[USB flash drive Access Error]	The file in the USB flash memory is not writable.	Check on the content of USB flash memory. Insert a USB flash memory into the slot again, and perform the required operation once more. If the problem is still not remedied, restart the printer and try to operate it once again.
4106	[Illegal Format]	The file in the USB flash memory is not accessible.	Check on the content of USB flash memory. Insert a USB flash memory into the slot again, and perform the required operation once more. If the problem is still not remedied, restart the printer and try to operate it once again.
4108	[USB flash drive Access Error]	The file in the USB flash memory is not readable.	Check on the content of USB flash memory. Insert a USB flash memory into the slot again, and perform the required operation once more. If the problem is still not remedied, restart the printer and try to operate it once again.
4200	[Machine Error]	An error has been detected in the display data on the LCD screen.	In the event that this error is displayed after suspending the updating of firmware, please start the updating operation over from the beginning. If the problem persists, please contact your dealer.
4201	[Machine Error]	An error has been detected in the display data on the LCD screen.	In the event that this error is displayed after suspending the updating of firmware, please start the updating operation over from the beginning. If the problem persists, please contact your dealer.
4202	[Machine Error]	An error has been detected in the display data on the LCD screen.	In the event that this error is displayed after suspending the updating of firmware, please start the updating operation over from the beginning. If the problem persists, please contact your dealer.

Error code	Error message	Description	Remedy
4400	[Test print data Error]	An error has been detected in the built-in test print data.	In the event that this error is displayed after suspending the updating of firmware, please start the updating operation over from the beginning. If the problem persists, please contact your dealer.
4401	[Test print data Error]	An error has been detected in the built-in test print data.	In the event that this error is displayed after suspending the updating of firmware, please start the updating operation over from the beginning. If the problem persists, please contact your dealer.
4402	[Test print data Error]	An error has been detected in the built-in test print data.	In the event that this error is displayed after suspending the updating of firmware, please start the updating operation over from the beginning. If the problem persists, please contact your dealer.
4500	[Machine Error]	Network-related settings have been failed.	Press the OK button to clear the error. Contact your network setup manager and network administrator. If the problem persists, please contact your dealer.
4501	[IP Address Setting Error]	Network-related settings have been failed.	Press the OK button to clear the error. Use the maintenance tool to set up a correct static IP address and subnet mask value once again.
4502	[Machine Error]	Network-related settings have been failed.	Press the OK button to clear the error. Contact your network setup manager and network administrator. If the problem persists, please contact your dealer.
4503	[Machine Error]	Network-related settings have been failed.	Press the OK button to clear the error. Use the maintenance tool to set up a correct static IP address of default gateway once again.
4504	[IP Address Setting Error]	Network-related settings have been failed.	Press the OK button to clear the error. Use the maintenance tool to set up a correct static IP address and subnet mask value once again.
4505	[Machine Error]	Network-related settings have been failed.	Press the OK button to clear the error.
4510	[Machine Error]	Network-related settings have been failed.	Press the OK button to clear the error. Make sure that the network settings are correct. Restart the printer and redo the network filtering settings if the settings are correct.
5010	[PC Data Error]	An error has been detected in the current print data being run.	Press the OK button to clear the error. Create the print data again on the PC to load it to the printer, and try the print operation again.



Error code	Error message	Description	Remedy
5020	[Machine Error]	An error has been detected during carriage control.	If the problem persists even after reactivating the printer, please contact your dealer.
5021	[Machine Error]	An error has been detected during the operation of the heads.	If the problem persists even after reactivating the printer, please contact your dealer.
5022	[Machine Error]	An error has been detected during the operation of the heads.	If the problem persists even after reactivating the printer, please contact your dealer.
5080	[Machine Error]	An error has been detected during maintenance unit control.	If the problem persists even after reactivating the printer, please contact your dealer.
5081	[Machine Error]	An error has been detected during maintenance unit control.	If the problem persists even after reactivating the printer, please contact your dealer.
5094	[Machine Error]	An error has been detected during platen loading.	If the problem persists even after reactivating the printer, please contact your dealer.
5095	[Machine Error]	An error has been detected during platen unloading.	If the problem persists even after reactivating the printer, please contact your dealer.
5096	[Machine Error]	An error has been detected while the platen is in operation during printing.	If the problem persists even after reactivating the printer, please contact your dealer.
5200	[Machine Error]	An error has been detected when the color 1 wiper was operated.	Check and see if any source produces a loud noise near the printer. If the problem persists even after reactivating the printer, please contact your dealer.
5201	[Machine Error]	An error has been detected when the color 2 wiper was operated.	Check and see if any source produces a loud noise near the printer. If the problem persists even after reactivating the printer, please contact your dealer.
5202	[Machine Error]	An error has been detected when the white 1 wiper was operated.	Check and see if any source produces a loud noise near the printer. If the problem persists even after reactivating the printer, please contact your dealer.
5203	[Machine Error]	An error has been detected when the white 2 wiper was operated.	Check and see if any source produces a loud noise near the printer. If the problem persists even after reactivating the printer, please contact your dealer.
5210	[Machine Error]	An error has been detected when the cap was operated.	Check and see if any source produces a loud noise near the printer. If the problem persists even after reactivating the printer, please contact your dealer.
5211	[Machine Error]	An error has been detected when the cap was operated.	Check and see if any source produces a loud noise near the printer. If the problem persists even after reactivating the printer, please contact your dealer.
5221	[Machine Error]	An error has been detected when the color 1 suction pump of the maintenance unit was operated.	Check and see if any source produces a loud noise near the printer. If the problem persists even after reactivating the printer, please contact your dealer.



Error code	Error message	Description	Remedy
5222	[Machine Error]	An error has been detected when the color 2 suction pump of the maintenance unit was operated.	Check and see if any source produces a loud noise near the printer. If the problem persists even after reactivating the printer, please contact your dealer.
5223	[Machine Error]	An error has been detected when the white 1 suction pump of the maintenance unit was operated.	Check and see if any source produces a loud noise near the printer. If the problem persists even after reactivating the printer, please contact your dealer.
5224	[Machine Error]	An error has been detected when the white 2 suction pump of the maintenance unit was operated.	Check and see if any source produces a loud noise near the printer. If the problem persists even after reactivating the printer, please contact your dealer.
5229	[Machine Error]	An error has been detected while checking the operation of the suction pump of the maintenance unit.	Check and see if any source produces a loud noise near the printer. If the problem persists even after reactivating the printer, please contact your dealer.
5600	[Machine Error]	An error has been detected during IC stick control.	Check that the IC stick is inserted correctly. If the problem persists even after reactivating the printer, please contact your dealer.
5601	[Machine Error]	An error has been detected during IC stick control.	Check that the IC stick is inserted correctly. If the problem persists even after reactivating the printer, please contact your dealer.
5602	[Machine Error]	An error has been detected during IC stick control.	Check that the IC stick is inserted correctly. If the problem persists even after reactivating the printer, please contact your dealer.
6004	[Machine Error]	An error in the platen obstacle sensor has been detected.	Check to see if the obstacle sensor is covered with something. If the problem persists even after reactivating the printer, please contact your dealer.
6006	[Machine Error]	The platen motor stopped abnormally.	Check and see if any source produces a loud noise near the printer. Restart the printer, and from the menu, select [Printer Setting] > [Platen settings] > [Platen Break-in Run]. If the problem persists after three platen break-in runs, please contact your dealer.
6007	[Machine Error]	An error has been detected while checking the mechanism for loading and unloading the platen.	Check and see if any source produces a loud noise near the printer. If the problem persists even after reactivating the printer, please contact your dealer.
6008	[Machine Error]	An error has been detected while checking the mechanism for raising and lowering the platen.	Check and see if any source produces a loud noise near the printer. If the problem persists even after reactivating the printer, please contact your dealer.
6010	[Machine Error]	An error has been detected when writing to the EEPROM on the main board.	Check and see if any source produces a loud noise near the printer. If the problem persists even after reactivating the printer, please contact your dealer.

Error code	Error message	Description	Remedy
6011	[Machine Error]	An error has been detected when writing to the flash ROM on the main board.	Check and see if any source produces a loud noise near the printer. If the problem persists even after reactivating the printer, please contact your dealer.
6012	[Machine Error]	An error has been detected when writing to the flash ROM on the main board.	Check and see if any source produces a loud noise near the printer. If the problem persists even after reactivating the printer, please contact your dealer.
6016	[Do Not Allow Restore Data]	An error has been detected when reading from the flash ROM on the panel board.	Check and see if any source produces a loud noise near the printer. If the problem persists even after reactivating the printer, please contact your dealer.
6021	[No Battery Detected]	The battery on the main board is dead.	For help, please contact your dealer.
6031	[Machine Error]	An error has been detected in the platen button at the startup.	Make sure that no buttons on the operation panel are pressed. If the problem persists, please contact your dealer.
6033	[Machine Error]	An error has been detected in the Cancel button at the startup.	Make sure that no buttons on the operation panel are pressed. If the problem persists, please contact your dealer.
6034	[Machine Error]	An error has been detected in the Left-arrow button at the startup.	Make sure that no buttons on the operation panel are pressed. If the problem persists, please contact your dealer.
6035	[Machine Error]	An error has been detected in the Right-arrow button at the startup.	Make sure that no buttons on the operation panel are pressed. If the problem persists, please contact your dealer.
6036	[Machine Error]	An error has been detected in the Down-arrow button at the startup.	Make sure that no buttons on the operation panel are pressed. If the problem persists, please contact your dealer.
6037	[Machine Error]	An error has been detected in the Up-arrow button at the startup.	Make sure that no buttons on the operation panel are pressed. If the problem persists, please contact your dealer.
6038	[Machine Error]	An error has been detected in the head cleaning button at the startup.	Make sure that no buttons on the operation panel are pressed. If the problem persists, please contact your dealer.
6039	[Machine Error]	An error has been detected in the MENU/OK button at the startup.	Make sure that no buttons on the operation panel are pressed. If the problem persists, please contact your dealer.

Error code	Error message	Description	Remedy
6040	[Machine Error]	An error has been detected in the print button on the right side at the startup.	Make sure that the corresponding button is not pressed. If the problem persists, please contact your dealer.
6041	[Machine Error]	An error has been detected in the print button on the left side at the startup.	Make sure that the corresponding button is not pressed. If the problem persists, please contact your dealer.
6042	[Machine Error]	An error has been detected in the platen stop button on the right side at the startup.	Make sure that the corresponding button is not pressed. If the problem persists, please contact your dealer.
6043	[Machine Error]	An error has been detected in the platen stop button on the left side at the startup.	Make sure that the corresponding button is not pressed. If the problem persists, please contact your dealer.
6045	[Machine Error]	A panel board for a different model is installed.	Restart the printer and update the firmware again. Check if the firmware update file is for the model of your printer. If the problem persists, please contact your dealer.
6046	[Machine Error]	The main board firmware and panel board firmware are not compatible.	Restart the printer and update the firmware again. Check if the firmware update file is for the model of your printer. If the problem persists, please contact your dealer.
6070	[Machine Error]	An error has been detected in the connector connection of the platen stop button on the right side.	Check and see if any source produces a loud noise near the printer. If the problem persists even after reactivating the printer, please contact your dealer.
6071	[Machine Error]	An error has been detected in the connector connection of the platen stop button on the left side.	Check and see if any source produces a loud noise near the printer. If the problem persists even after reactivating the printer, please contact your dealer.
6105	[Machine Error]	Carriage initialization has been failed.	Check to see if something gets caught in the carriage or any foreign object exists inside the printer. Also, clean the printer interior. If the problem persists, please contact your dealer.
6109	[Machine Error]	Printing stopped abnormally.	Check and see if any source produces a loud noise near the printer. If the problem persists even after reactivating the printer, please contact your dealer.
6130	[Machine Error Adjust CR]	Abnormal decrease in the carriage speed has been detected.	Clean the carriage. If the problem persists, please contact your dealer.
6131	[Machine Error Adjust CR]	Abnormal decrease in the carriage speed has been detected.	Clean the carriage. If the problem persists, please contact your dealer.

Error code	Error message	Description	Remedy
6150	[Machine Error]	Error detected in the carriage drive.	Make sure you are powering the printer from a stable power source. Check and see if any source produces a loud noise near the printer. If the problem persists even after reactivating the printer, please contact your dealer.
6221	[Machine Error]	An error has been detected in the temperature of color head A.	Ascertain whether or not the cable for the heads is disconnected. If the problem persists even after reactivating the printer, please contact your dealer.
6222	[Machine Error]	An error has been detected in the temperature of color head B.	Ascertain whether or not the cable for the heads is disconnected. If the problem persists even after reactivating the printer, please contact your dealer.
6223	[Machine Error]	An error has been detected in the temperature of white head A.	Ascertain whether or not the cable for the heads is disconnected. If the problem persists even after reactivating the printer, please contact your dealer.
6224	[Machine Error]	An error has been detected in the temperature of white head B.	Ascertain whether or not the cable for the heads is disconnected. If the problem persists even after reactivating the printer, please contact your dealer.
6231	[Machine Error]	An error has been detected in the voltage of color head A.	Ascertain whether or not the cable for the heads is disconnected. If the problem persists even after reactivating the printer, please contact your dealer.
6232	[Machine Error]	An error has been detected in the voltage of color head B.	Ascertain whether or not the cable for the heads is disconnected. If the problem persists even after reactivating the printer, please contact your dealer.
6233	[Machine Error]	An error has been detected in the voltage of white head A.	Ascertain whether or not the cable for the heads is disconnected. If the problem persists even after reactivating the printer, please contact your dealer.
6234	[Machine Error]	An error has been detected in the voltage of white head B.	Ascertain whether or not the cable for the heads is disconnected. If the problem persists even after reactivating the printer, please contact your dealer.
6241	[Machine Error]	An error has been detected in the FFC connection of color head A.	Ascertain whether or not the cable for the heads is disconnected. If the problem persists even after reactivating the printer, please contact your dealer.
6242	[Machine Error]	An error has been detected in the FFC connection of color head B.	Ascertain whether or not the cable for the heads is disconnected. If the problem persists even after reactivating the printer, please contact your dealer.

Error code	Error message	Description	Remedy
6243	[Machine Error]	An error has been detected in the FFC connection of white head A.	Ascertain whether or not the cable for the heads is disconnected. If the problem persists even after reactivating the printer, please contact your dealer.
6244	[Machine Error]	An error has been detected in the FFC connection of white head B.	Ascertain whether or not the cable for the heads is disconnected. If the problem persists even after reactivating the printer, please contact your dealer.
6251	[Machine Error]	An error has been detected in the fan of color head A.	Check and see if any source produces a loud noise near the printer. If the problem persists even after reactivating the printer, please contact your dealer.
6252	[Machine Error]	An error has been detected in the fan of color head B.	Check and see if any source produces a loud noise near the printer. If the problem persists even after reactivating the printer, please contact your dealer.
6253	[Machine Error]	An error has been detected in the fan of white head A.	Check and see if any source produces a loud noise near the printer. If the problem persists even after reactivating the printer, please contact your dealer.
6254	[Machine Error]	An error has been detected in the fan of white head B.	Check and see if any source produces a loud noise near the printer. If the problem persists even after reactivating the printer, please contact your dealer.
7000	[Machine Error]	The software detected an internal error.	Check and see if any source produces a loud noise near the printer. If the problem persists even after reactivating the printer, please contact your dealer.
7012	[Machine Error]	The software detected an internal error.	Check and see if any source produces a loud noise near the printer. If the problem persists even after reactivating the printer, please contact your dealer.
7013	[Machine Error]	The software detected an internal error.	Check and see if any source produces a loud noise near the printer. If the problem persists even after reactivating the printer, please contact your dealer.
7015	[Machine Error]	The software detected an internal error.	Check and see if any source produces a loud noise near the printer. If the problem persists even after reactivating the printer, please contact your dealer.
7020	[Machine Error]	The software detected an internal error.	Check and see if any source produces a loud noise near the printer. If the problem persists even after reactivating the printer, please contact your dealer.
7021	[Machine Error]	The software detected an internal error.	Check and see if any source produces a loud noise near the printer. If the problem persists even after reactivating the printer, please contact your dealer.

Error code	Error message	Description	Remedy
8040	[Machine Error]	An error has been detected in the sensor of the black sub tank.	Check and see if any source produces a loud noise near the printer. If the problem persists even after reactivating the printer, please contact your dealer.
8041	[Machine Error]	An error has been detected in the sensor of the yellow sub tank.	Check and see if any source produces a loud noise near the printer. If the problem persists even after reactivating the printer, please contact your dealer.
8042	[Machine Error]	An error has been detected in the sensor of the cyan sub tank.	Check and see if any source produces a loud noise near the printer. If the problem persists even after reactivating the printer, please contact your dealer.
8043	[Machine Error]	An error has been detected in the sensor of the magenta sub tank.	Check and see if any source produces a loud noise near the printer. If the problem persists even after reactivating the printer, please contact your dealer.
8044	[Machine Error]	An error has been detected in the sensor of white 1 sub tank.	Check and see if any source produces a loud noise near the printer. If the problem persists even after reactivating the printer, please contact your dealer.
8045	[Machine Error]	An error has been detected in the sensor of white 2 sub tank.	Check and see if any source produces a loud noise near the printer. If the problem persists even after reactivating the printer, please contact your dealer.
8060	[Machine Error]	Failed to fill the black sub tank with ink.	Check and see if any source produces a loud noise near the printer. If the problem persists even after reactivating the printer, please contact your dealer.
8061	[Machine Error]	Failed to fill the yellow sub tank with ink.	Check and see if any source produces a loud noise near the printer. If the problem persists even after reactivating the printer, please contact your dealer.
8062	[Machine Error]	Failed to fill the cyan sub tank with ink.	Check and see if any source produces a loud noise near the printer. If the problem persists even after reactivating the printer, please contact your dealer.
8063	[Machine Error]	Failed to fill the magenta sub tank with ink.	Check and see if any source produces a loud noise near the printer. If the problem persists even after reactivating the printer, please contact your dealer.
8064	[Machine Error]	Failed to fill the white 1 sub tank with ink.	Check and see if any source produces a loud noise near the printer. If the problem persists even after reactivating the printer, please contact your dealer.
8065	[Machine Error]	Failed to fill the white 2 sub tank with ink.	Check and see if any source produces a loud noise near the printer. If the problem persists even after reactivating the printer, please contact your dealer.

Error code	Error message	Description	Remedy
8069	[Machine Error]	Failed to fill the cleaning solution sub tank with ink.	Check and see if any source produces a loud noise near the printer. If the problem persists even after reactivating the printer, please contact your dealer.
8070	[Machine Error]	Failed to discharge ink from the black sub tank.	Check and see if any source produces a loud noise near the printer. If the problem persists even after reactivating the printer, please contact your dealer.
8071	[Machine Error]	Failed to discharge ink from the yellow sub tank.	Check and see if any source produces a loud noise near the printer. If the problem persists even after reactivating the printer, please contact your dealer.
8072	[Machine Error]	Failed to discharge ink from the cyan sub tank.	Check and see if any source produces a loud noise near the printer. If the problem persists even after reactivating the printer, please contact your dealer.
8073	[Machine Error]	Failed to discharge ink from the magenta sub tank.	Check and see if any source produces a loud noise near the printer. If the problem persists even after reactivating the printer, please contact your dealer.
8074	[Machine Error]	Failed to discharge ink from the white 1 sub tank.	Check and see if any source produces a loud noise near the printer. If the problem persists even after reactivating the printer, please contact your dealer.
8075	[Machine Error]	Failed to discharge ink from the white 2 sub tank.	Check and see if any source produces a loud noise near the printer. If the problem persists even after reactivating the printer, please contact your dealer.



Error code	Error message	Description	Remedy
8080	[Machine Error]	An error has been detected in the remaining volume sensor of the black main tank.	Check and see if any source produces a loud noise near the printer. If the problem persists even after reactivating the printer, please contact your dealer.
8081	[Machine Error]	An error has been detected in the remaining volume sensor of the yellow main tank.	
8082	[Machine Error]	An error has been detected in the remaining volume sensor of the cyan main tank.	
8083	[Machine Error]	An error has been detected in the remaining volume sensor of the magenta main tank.	
8084	[Machine Error]	An error has been detected in the remaining volume sensor of the white main tank.	
8089	[Machine Error]	An error has been detected in the remaining volume sensor of the cleaning solution main tank.	
8094	[Machine Error]	Unable to agitate the white main tank.	Check and see if any source produces a loud noise near the printer. If the problem persists even after reactivating the printer, please contact your dealer.
8100	[Machine Error]	Failed to fill the black head with ink.	Check and see if any source produces a loud noise near the printer. If the problem persists even after reactivating the printer, please contact your dealer.
8101	[Machine Error]	Failed to fill the yellow head with ink.	
8102	[Machine Error]	Failed to fill the cyan head with ink.	
8103	[Machine Error]	Failed to fill the magenta head with ink.	
8104	[Machine Error]	Failed to fill the white A head with ink.	
8105	[Machine Error]	Failed to fill the white B head with ink.	
8200	[During humidifier water supply an error was detected]	An error has been detected when water was supplied to the humidifier unit.	Make sure the humidifier is supplied with water. Check and see if the water supply tube is disconnected, torn, broken, or contaminated with air. If the problem persists, please contact your dealer.
8201	[During humidifier water supply an error was detected]	An error has been detected when water was supplied to the humidifier unit.	
8202	[During humidifier water supply an error was detected]	An error has been detected when water was supplied to the humidifier unit.	Make sure that the water supply pressure to the humidifier is not too high. If the problem persists, please contact your dealer.



Error code	Error message	Description	Remedy
8203	[Humidifier drainage error]	An error has been detected when draining from the humidifier unit.	Check and see if any source produces a loud noise near the printer. If the problem persists even after reactivating the printer, please contact your dealer.
8210	[Humi. drain tank not in position]	The humidifier drain tank is not installed.	Make sure that the humidifier drain tank is installed. If the problem persists even after reactivating the printer, please contact your dealer.
8211	[Humidifier drain tank full]	The humidifier drain tank is full.	Empty the humidifier drain tank.
8212	[Humidifier drain tank full]	The humidifier drain tank will be full soon.	
8220	[Humidification error]	An error has been detected in the humidification fan.	Check and see if any source produces a loud noise near the printer. If the problem persists even after reactivating the printer, please contact your dealer.
8221	[Machine Error]	An error has been detected in the remaining volume sensor of the water supply tank of the humidifier unit.	Check and see if any source produces a loud noise near the printer. If the problem persists even after reactivating the printer, please contact your dealer.

In the event that other error codes than those that are mentioned above are displayed, please contact your dealer for help.

# 10 Specifications

## 10-1. Apparatus

Printing method		Direct cloth printing by color ink jet printing		
Head	Quantity	4 pcs.		
Resolution	Maximum	1200 dpi x 1200 dpi		
Ink	Type	Water-based ink		
	Number of colors	5 colors of CMYKW		
Material supply method		Platen transportation method		
Supported media (size/thickness)	Size	14 in. (355.6 mm) × 16 in. (406.4 mm) (standard platen)		
	Thickness	Up to 1.2 in. (30 mm)		
Printable area	Maximum	24.2 in. (615 mm) × 24.2 in. (615 mm)		
Interface		LAN (10BASE-T, 100BASE-TX, 1000BASE-T), USB flash memory		
External dimensions		73.6 in. (width) x 75.6 in. (depth) x 57.5 in. (height) (1870 mm (width) x 1920 mm (depth) x 1460 mm (height)) (Platen is accommodated) 73.6 in. (width) x 81.1 in. (depth) x 57.5 in. (height) (1870 mm (width) x 2060 mm (depth) x 1460 mm (height)) (including platen)		
Weight		730 kg (1609 lb) (including platen)		
Installation conditions Environment	Power		Single phase, 200 V-240 V, 50/60 Hz	
	Power consumptions		When active: 5 A max.	
	Temperature and humidity environment	Recomm ended print environ ment	Temperature: 18 to 30°C (64.4 to 86°F) Humidity: 35 to 85% (no condensation)	<p>Printing-guaranteed range</p> <p>Legend:  <span style="display:inline-block; width:10px; height:10px; background-color:darkgrey;"></span> Recommended print environment  <span style="display:inline-block; width:10px; height:10px; background-color:mediumgrey;"></span> Working environment  <span style="display:inline-block; width:10px; height:10px; background-color:lightgrey;"></span> Storage environment</p> <p>Temperature (°C) X0394</p>
		Working Environ ment	Temperature: 10 to 35°C (50 to 95°F) Humidity: 20 to 85% (no condensation)	
Storage environ ment		Temperature: 0 to 40°C (32 to 104°F) Humidity: 20 to 85% (no condensation)		
Print direction		Bidirectional, unidirectional		
Fixation conditions		Conveyor oven (recommended): 160°C (320 °F) for 3.5 minutes, or heat press: 180°C (356°F) for 35 seconds * The time taken for fixation differs depending on the fixation device.		
Pretreatment		Pretreatment is required when you print using white ink. Apply pretreatment with a pretreatment device and dry it up with a heat press.		

**10-2. Software**

OS	Windows 10 (64bit), macOS Catalina, macOS BigSur
Min. operating environment	CPU with 2 GHz or above RAM with 4 GB or above
Display resolution	SXGA (1280 x 1024) or higher
Output	Printer driver, GTX Graphics Lab
Application software for high-level image editing	Adobe® Photoshop CC, Adobe® Illustrator CC, CorelDRAW® 2020/2021 (Windows)

### 10-3. Ink, maintenance solution, cleaning solution, pretreatment

#### 10-3-1. Ink

Name		Black / Magenta / Cyan / Yellow / White
Use expiration date		Expiration date printed on the bottle (supposing storage at normal temperature)
Storage temperature		0 to 40°C (32 to 104°F)
Cautions for storage		<ul style="list-style-type: none"> <li>- Store them in a place where they are not exposed to direct sunlight.</li> <li>- Keep them out of the reach of children.</li> <li>- Store them away from fire, heat and oxidized substance.</li> <li>• Take care not to lose the IC stick.</li> </ul>
Content		18 L, 9 L
External dimensions in transport condition	18 L (1-piece set)	11.6 in. (width) x 11.6 in. (depth) x 20.0 in. (height) (294 mm (width) x 294 mm (depth) x 507 mm (height))
	9 L (1-piece set)	10.0 in. (width) x 10.0 in. (depth) x 15.9 in. (height) (254 mm (width) x 254 mm (depth) x 405 mm (height))

#### 10-3-2. Maintenance solution

Name		Maintenance solution
Use expiration date		Expiration date on the container (supposing storage at normal temperature)
Storage temperature		0 to 40°C (32 to 104°F)
Cautions for storage		<ul style="list-style-type: none"> <li>- Store them in a place where they are not exposed to direct sunlight.</li> <li>- Keep them out of the reach of children.</li> <li>- Store them away from fire, heat and oxidized substance.</li> </ul>
Content		5 kg (11 lb)
External dimensions in transport condition	4-piece set	18.0 in. (width) x 12.6 in. (depth) x 12.5 in. (height) (456 mm (width) x 320 mm (depth) x 318 mm (height))

#### 10-3-3. Cleaning solution

Name		Cleaning solution (for GTX-6)
Use expiration date		Expiration date on the container (supposing storage at normal temperature)
Storage temperature		0 to 40°C (32 to 104°F)
Cautions for storage		<ul style="list-style-type: none"> <li>- Store them in a place where they are not exposed to direct sunlight.</li> <li>- Keep them out of the reach of children.</li> <li>- Store them away from fire, heat and oxidized substance.</li> <li>-Cap the container tightly, and keep it in a cool, dark place with good ventilation.</li> </ul>
Content		18 L, 9 L
External dimensions in transport condition	18 L (1-piece set)	11.6 in. (width) x 11.6 in. (depth) x 20.0 in. (height) (294 mm (width) x 294 mm (depth) x 507 mm (height))
	9 L (1-piece set)	10.0 in. (width) x 10.0 in. (depth) x 15.9 in. (height) (254 mm (width) x 254 mm (depth) x 405 mm (height))

### 10-3-4. Pretreatment

Name		Pretreatment
Use expiration date		Expiration date on the outer case (supposing storage at normal temperature)
Storage temperature		0 to 40°C (32 to 104°F)
Cautions for storage		<ul style="list-style-type: none"> <li>- Store them in a place where they are not exposed to direct sunlight.</li> <li>- Keep them out of the reach of children.</li> <li>- Store them away from fire, heat and oxidized substance.</li> <li>-Cap the container tightly, and keep it in a cool, dark place with good ventilation.</li> </ul>
Content		200 kg (440 lb), 20 kg (44 lb), 5 kg (11 lb)
External dimensions in transport condition	200 kg (440 lb) (2-piece set)	46.5 in. (width) x 23.6 in. (depth) x 40.6 in. (height) (1180 mm (width) x 600 mm (depth) x 1030 mm (height))
	20 kg (44 lb) (1-piece set)	10.4 in. (width) x 10.4 in. (depth) x 15.9 in. (height) (265 mm (width) x 265 mm (depth) x 405 mm (height))
	5 kg (11 lb) (4-piece set)	12.6 in. (width) x 18.0 in. (depth) x 12.5 in. (height) (320 mm (width) x 456 mm (depth) x 318 mm (height))

## 10-4. About consumable supplies, optional items and replacement parts

### About consumable supplies, optional items and replacement parts

- Consumable supplies: Components required for the printing operation
- Optional items: Available items through purchase order according to customers' usage status
- Replacement parts: Components for which periodic maintenance needs to be performed for you to optimize the printer's operation

Consumable supplies		Code No.
Black ink bottle	9 L	GCX-6K09L-1
	18 L	GCX-6K18L-1
Magenta ink bottle	9 L	GCX-6M09L-1
	18 L	GCX-6M18L-1
Cyan ink bottle	9 L	GCX-6C09L-1
	18 L	GCX-6C18L-1
Yellow ink bottle	9 L	GCX-6Y09L-1
	18 L	GCX-6Y18L-1
White ink bottle	9 L	GCX-6W09L
	18 L	GCX-6W18L
Cleaning solution (for GTX-6)	9 L	GCX-6E09L
	18 L	GCX-6E18L
Pretreatment	5 kg (11 lb)	GCX-4PS05
	20 kg (44 lb)	GCX-4PS20
	200 kg (440 lb)	GCX-4PS2H
Maintenance solution	5 kg (11 lb)	GC-50S5K
Maintenance kit A <Printer-supplied items>		SC5033
Wiper		
Cap foam/Cap chip		
Flushing foam		
Plastic gloves	2	
Clean stick R	10 pcs.	
Clean stick T	10 pcs.	
Carriage foam		
Clean stick R	50-piece set	SB7008
Clean stick T	50-piece set	SC0032
Cap foam/Cap chip		SC5084
Flushing foam		SC4848
Wiper		SC4894
Mist fan filter set <Printer-supplied items>		SC5066
Mist fan filter	2-piece set	
Plastic gloves	2	

Optional items	Code No.
Platen size SS (7.3 in. (185 mm) × 9.1 in. (230 mm))	SB7001
Platen sheet 7×8	SB7002
Platen size S (10.6 in. (270 mm) × 12.6 in. (320 mm))	SC4870
Platen sheet 10×12	SC3058
Platen size M (Provided with the printer) (12.6 in. (370 mm) × 16.5 in. (420 mm))	SC4871
Platen sheet 14×16	SC4577
Platen size L (16.5 in. (420 mm) × 16.5 in. (420 mm))	SC4872
Platen sheet 16×18	SC3060
Platen size XL (18.2 in. (463 mm) × 22.2 in. (565 mm))	SC4873
Platen sheet 18×22	SC3541
Platen size XXL (24.2 in. (615 mm) × 24.2 in. (615 mm))	SC4874
Platen sheet 24×24	SC3542
Platen size S assembly X6F	SC6136
Platen size M assembly X6F	SC6137
Platen size L assembly X6F	SC6138
Platen size XL assembly X6F	SC6139
Water tank supply ASSY	SC5068
Water T6040 20M	SC5070
L-shaped fitting 06-06	SC5071
AC cord PSE	SC6043
AC cord UL/CSA	SC6044
AC cord EUR	SC6045
AC cord China	SC6047
AC cord AU	SC6046

Replacement parts	Code No.
White head A	SC3355
White head B	
Color head A	SC3340
Color head B	
Main tank filter (color)	SB7680
Main tank filter (cleaning solution)	SB7680
Main tank filter (white)	SC1643
Return filter (white)	SC1695
Circulation filter (white)	SB7680
Head filter (color)	SB7093
Head filter (white)	SC1695
Cleaning cup	SB6925
Waste ink tank	SC4946
Waste water tank	SC4946
Humidifier fan filter	SC5138
Encoder strip	SC2555
Encoder sensor board	SC3262
CR origin sensor	LG2239

Ink bottle for each color  
9 L

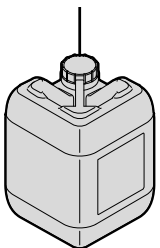

Ink bottle for each color  
18 L

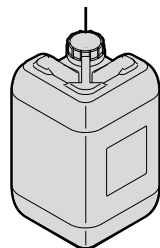

Cleaning solution (for GTX-6)  
9 L

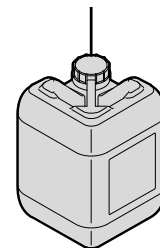

Cleaning solution (for GTX-6)  
18 L

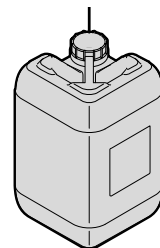

Pretreatment  
5 kg (11 lb)

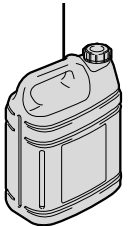

Pretreatment  
20 kg (44 lb)

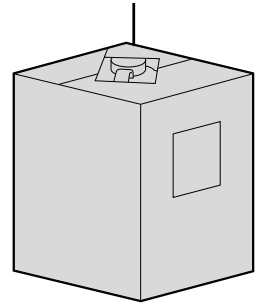

Pretreatment  
200 kg (440 lb)

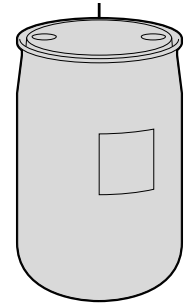

Maintenance solution  
5 kg (11 lb)

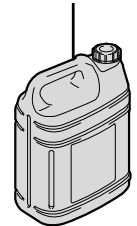

Maintenance kit A

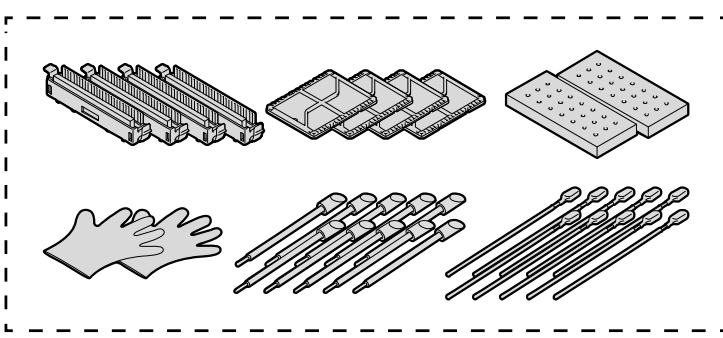

Mist fan filter set

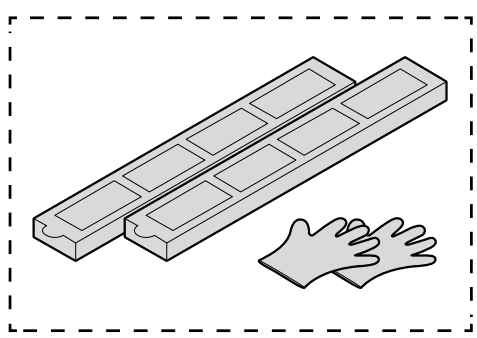

Carriage foam

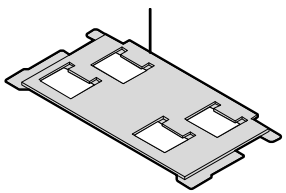

Clean stick R

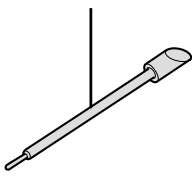

Clean stick T

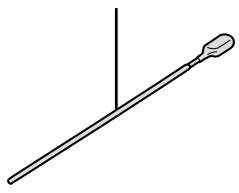

Cap foam  
Cap chip

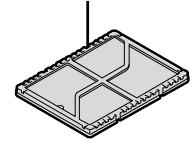

Flushing foam

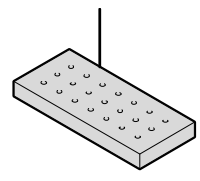

Water tank supply ASSY

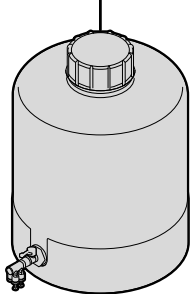

White head

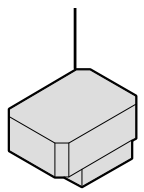

Color head

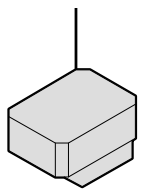

Main tank filter  
(white)

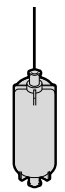



## Open Source Licensing Remarks

This product uses one or more of the following open software, depending on the features which each product has.

gSOAP / SNMP Software from West Hawk / OpenSSL / Lua This software is used in all our products.

### MIT Kerberos

This software is used in the product which supports the Kerberos Authentication.

### Cyrus SASL / OpenLDAP

This software is used in the product which supports LDAP.

### expat/ LibTIFF/ libjpeg/ libpng

This software is used in the product which supports RSS Reader, XPS emulation for Direct Print feature, or PDF creation module.

### libstrophe/json-c

This software is used in the product which supports Google Cloud Print.

### Open SSH

This software is used in the product which supports Secure Scan FTP.

### Open NFC / linux\_libnfc-nci

This software is used in the product which supports NFC.

### USB Host Driver (in FreeBSD)

This software is used in the product which supports Direct Print / Scan to USB.

### mDNSResponder

This software is used in the product which supports mDNS.

### wpa\_supplicant and hostapd

This software is used in the product which supports Wireless LAN or IEEE802.1X.

### T-Kernel

This software is used in the product as Operating System.

The following is the full text.

=====  
Part of the software embedded in this product is gSOAP software.

Portions created by gSOAP are Copyright (C) 2001 2004 Robert A. van Engelen, Genivia inc. All Rights Reserved.

THE SOFTWARE IN THIS PRODUCT WAS IN PART PROVIDED BY GENIVIA INC AND ANY EXPRESS OR IMPLIED WARRANTIES, INCLUDING, BUT NOT LIMITED TO, THE IMPLIED WARRANTIES OF MERCHANTABILITY AND FITNESS FOR A PARTICULAR PURPOSE ARE DISCLAIMED. IN NO EVENT SHALL THE AUTHOR BE LIABLE FOR ANY DIRECT, INDIRECT, INCIDENTAL, SPECIAL, EXEMPLARY, OR CONSEQUENTIAL DAMAGES (INCLUDING, BUT NOT LIMITED TO, PROCUREMENT OF SUBSTITUTE GOODS OR SERVICES; LOSS OF USE, DATA, OR PROFITS; OR BUSINESS INTERRUPTION) HOWEVER CAUSED AND ON ANY THEORY OF LIABILITY, WHETHER IN CONTRACT, STRICT LIABILITY, OR TORT (INCLUDING NEGLIGENCE OR OTHERWISE) ARISING IN ANYWAY OUT OF THE USE OF THIS SOFTWARE, EVEN IF ADVISED OF THE POSSIBILITY OF SUCH DAMAGE.

Permission to use, copy, modify, and distribute this software for any purpose and without fee is hereby granted, provided that the above copyright notices appear in all copies and that both the copyright notice and this permission notice appear in supporting documentation. This software is provided "as is" without express or implied warranty.

.....  
=====

This product includes SNMP software from WestHawk Ltd.

Copyright (C) 2000, 2001, 2002 by Westhawk Ltd

Permission to use, copy, modify, and distribute this software for any purpose and without fee is hereby granted, provided that the above copyright notices appear in all copies and that both the copyright notice and this permission notice appear in supporting documentation. This software is provided "as is" without express or implied warranty.

=====

MIT Kerberos statements

-----

MIT Kerberos license copyright Version 1.6.3

Copyright (C) 1985-2007 by the Massachusetts Institute of Technology. All rights reserved.

Export of this software from the United States of America may require a specific license from the United States Government. It is the responsibility of any person or organization contemplating export to obtain such a license before exporting.

WITHIN THAT CONSTRAINT, permission to use, copy, modify, and distribute this software and its documentation for any purpose and without fee is hereby granted, provided that the above copyright notice appear in all copies and that both that copyright notice and this permission notice appear in supporting documentation, and that the name of M.I.T. not be used in advertising or publicity pertaining to distribution of the software without specific, written prior permission. Furthermore if you modify this software you must label your software as modified software and not distribute it in such a fashion that it might be confused with the original MIT software. M.I.T. makes no representations about the suitability of this software for any purpose.

It is provided "as is" without express or implied warranty.

THIS SOFTWARE IS PROVIDED "AS IS" AND WITHOUT ANY EXPRESS OR IMPLIED WARRANTIES, INCLUDING, WITHOUT LIMITATION, THE IMPLIED WARRANTIES OF MERCHANTABILITY AND FITNESS FOR A PARTICULAR PURPOSE.

Copyright (C) 1998 by the FundsXpress, INC. All rights reserved.

Export of this software from the United States of America may require a specific license from the United States Government. It is the responsibility of any person or organization contemplating export to obtain such a license before exporting.

WITHIN THAT CONSTRAINT, permission to use, copy, modify, and distribute this software and its documentation for any purpose and without fee is hereby granted, provided that the above copyright notice appear in all copies and that both that copyright notice and this permission notice appear in supporting documentation, and that the name of FundsXpress. not be used in advertising or publicity pertaining to distribution of the software without specific, written prior permission. FundsXpress makes no representations about the suitability of this software for any purpose. It is provided "as is" without express or implied warranty.

THIS SOFTWARE IS PROVIDED "AS IS" AND WITHOUT ANY EXPRESS OR IMPLIED WARRANTIES, INCLUDING, WITHOUT LIMITATION, THE IMPLIED WARRANTIES OF MERCHANTABILITY AND FITNESS FOR A PARTICULAR PURPOSE.

Copyright 1993, 1995 by OpenVision Technologies, Inc.

Permission to use, copy, modify, distribute, and sell this software and its documentation for any purpose is hereby granted without fee, provided that the above copyright notice appears in all copies and that both that copyright notice and this permission notice appear in supporting documentation, and that the name of OpenVision not be used in advertising or publicity pertaining to distribution of the software without specific, written prior permission. OpenVision makes no representations about the suitability of this software for any purpose. It is provided "as is" without express or implied warranty.

OPENVISION DISCLAIMS ALL WARRANTIES WITH REGARD TO THIS SOFTWARE, INCLUDING ALL IMPLIED WARRANTIES OF MERCHANTABILITY AND FITNESS, IN NO EVENT SHALL OPENVISION BE LIABLE FOR ANY SPECIAL, INDIRECT OR CONSEQUENTIAL DAMAGES OR ANY DAMAGES WHATSOEVER RESULTING FROM LOSS OF USE, DATA OR PROFITS, WHETHER IN AN ACTION OF CONTRACT, NEGLIGENCE OR OTHER TORTIOUS ACTION, ARISING OUT OF OR IN CONNECTION WITH THE USE OR PERFORMANCE OF THIS SOFTWARE.

Copyright 2000 by Zero-Knowledge Systems, Inc.

Permission to use, copy, modify, distribute, and sell this software and its documentation for any purpose is hereby granted without fee, provided that the above copyright notice appear in all copies and that both that copyright notice and this permission notice appear in supporting documentation, and that the name of Zero-Knowledge Systems, Inc. not be used in advertising or publicity pertaining to distribution of the software without specific, written prior permission. Zero-Knowledge Systems, Inc. makes no representations about the suitability of this software for any purpose. It is provided "as is" without express or implied warranty.

ZERO-KNOWLEDGE SYSTEMS, INC. DISCLAIMS ALL WARRANTIES WITH REGARD TO THIS SOFTWARE, INCLUDING ALL IMPLIED WARRANTIES OF MERCHANTABILITY AND FITNESS, IN NO EVENT SHALL ZERO-KNOWLEDGE SYSTEMS, INC. BE LIABLE FOR ANY SPECIAL, INDIRECT OR CONSEQUENTIAL DAMAGES OR ANY DAMAGES WHATSOEVER RESULTING FROM LOSS OF USE, DATA OR PROFITS, WHETHER IN AN ACTION OF CONTRACT, NEGLIGENCE OR OTHER TORTUOUS ACTION, ARISING OUT OF OR IN CONNECTION WITH THE USE OR PERFORMANCE OF THIS SOFTWARE.

Copyright (c) 2006 Red Hat, Inc.

Portions copyright (c) 2006 Massachusetts Institute of Technology All Rights Reserved.

Redistribution and use in source and binary forms, with or without modification, are permitted provided that the following conditions are met:

- \* Redistributions of source code must retain the above copyright notice, this list of conditions and the following disclaimer.
- \* Redistributions in binary form must reproduce the above copyright notice, this list of conditions and the following disclaimer in the documentation and/or other materials provided with the distribution.
- \* Neither the name of Red Hat, Inc., nor the names of its contributors may be used to endorse or promote products derived from this software without specific prior written permission.

THIS SOFTWARE IS PROVIDED BY THE COPYRIGHT HOLDERS AND CONTRIBUTORS "AS IS" AND ANY EXPRESS OR IMPLIED WARRANTIES,

INCLUDING, BUT NOT LIMITED TO, THE IMPLIED WARRANTIES OF MERCHANTABILITY AND FITNESS FOR A PARTICULAR PURPOSE ARE DISCLAIMED. IN NO EVENT SHALL THE COPYRIGHT OWNER OR CONTRIBUTORS BE LIABLE FOR ANY DIRECT, INDIRECT, INCIDENTAL, SPECIAL, EXEMPLARY, OR CONSEQUENTIAL DAMAGES (INCLUDING, BUT NOT LIMITED TO, PROCUREMENT OF SUBSTITUTE GOODS OR SERVICES; LOSS OF USE, DATA, OR PROFITS; OR BUSINESS INTERRUPTION) HOWEVER CAUSED AND ON ANY THEORY OF LIABILITY, WHETHER IN CONTRACT, STRICT LIABILITY, OR TORT (INCLUDING NEGLIGENCE OR OTHERWISE) ARISING IN ANY WAY OUT OF THE USE OF THIS SOFTWARE, EVEN IF ADVISED OF THE POSSIBILITY OF SUCH DAMAGE.

Copyright 1995,1996,2003,2004 by Sun Microsystems, Inc.

Permission to use, copy, modify, distribute, and sell this software and its documentation for any purpose is hereby granted without fee, provided that the above copyright notice appears in all copies and that both that copyright notice and this permission notice appear in supporting documentation, and that the name of Sun Microsystems not be used in advertising or publicity pertaining to distribution of the software without specific, written prior permission. Sun Microsystems makes no representations about the suitability of this software for any purpose. It is provided "as is" without express or implied warranty.

SUN MICROSYSTEMS DISCLAIMS ALL WARRANTIES WITH REGARD TO THIS SOFTWARE, INCLUDING ALL IMPLIED WARRANTIES OF MERCHANTABILITY AND FITNESS, IN NO EVENT SHALL SUN MICROSYSTEMS BE LIABLE FOR ANY SPECIAL, INDIRECT OR CONSEQUENTIAL DAMAGES OR ANY DAMAGES WHATSOEVER RESULTING FROM LOSS OF USE, DATA OR PROFITS, WHETHER IN AN ACTION OF CONTRACT, NEGLIGENCE OR OTHER TORTIOUS ACTION, ARISING OUT OF OR IN CONNECTION WITH THE USE OR PERFORMANCE OF THIS SOFTWARE.

COPYRIGHT (C) 2006-2007

THE REGENTS OF THE UNIVERSITY OF MICHIGAN ALL RIGHTS RESERVED.

Permission is granted to use, copy, create derivative works and redistribute this software and such derivative works for any purpose, so long as the name of The University of Michigan is not used in any advertising or publicity pertaining to the use of distribution of this software without specific, written prior authorization. If the above copyright notice or any other identification of the University of Michigan is included in any copy of any portion of this software, then the disclaimer below must also be included.

THIS SOFTWARE IS PROVIDED AS IS, WITHOUT REPRESENTATION FROM THE UNIVERSITY OF MICHIGAN AS TO ITS FITNESS FOR ANY PURPOSE, AND WITHOUT WARRANTY BY THE UNIVERSITY OF MICHIGAN OF ANY KIND, EITHER EXPRESS OR IMPLIED, INCLUDING WITHOUT LIMITATION THE IMPLIED WARRANTIES OF MERCHANTABILITY AND FITNESS FOR A PARTICULAR PURPOSE. THE REGENTS OF THE UNIVERSITY OF MICHIGAN SHALL NOT BE LIABLE FOR ANY DAMAGES, INCLUDING SPECIAL, INDIRECT, INCIDENTAL, OR CONSEQUENTIAL DAMAGES, WITH RESPECT TO ANY CLAIM ARISING OUT OF OR IN CONNECTION WITH THE USE OF THE SOFTWARE, EVEN IF IT HAS BEEN OR IS HEREAFTER ADVISED OF THE POSSIBILITY OF SUCH DAMAGES.

Copyright (c) 2002 Naval Research Laboratory (NRL/CCS)

Permission to use, copy, modify and distribute this software and its documentation is hereby granted, provided that both the copyright notice and this permission notice appear in all copies of the software, derivative works or modified versions, and any portions thereof.

NRL ALLOWS FREE USE OF THIS SOFTWARE IN ITS "AS IS" CONDITION AND DISCLAIMS ANY LIABILITY OF ANY KIND FOR ANY DAMAGES WHATSOEVER RESULTING FROM THE USE OF THIS SOFTWARE.

Copyright (C) 1986 Gary S. Brown. You may use this program, or code or tables extracted from it, as desired without restriction.

Copyright (c) 1994 CyberSAFE Corporation

Copyright (c) 1993 Open Computing Security Group

=====  
Cyrus SASL statements  
=====

-----  
The Cyrus SASL License

Copyright (c) 1998-2003 Carnegie Mellon University. All rights reserved.

Redistribution and use in source and binary forms, with or without modification, are permitted provided that the following conditions are met:

1. Redistributions of source code must retain the above copyright notice, this list of conditions and the following disclaimer.
2. Redistributions in binary form must reproduce the above copyright notice, this list of conditions and the following disclaimer in the documentation and/or other materials provided with the distribution.
3. The name "Carnegie Mellon University" must not be used to endorse or promote products derived from this software without prior written permission. For permission or any other legal details, please contact.

Office of Technology Transfer  
Carnegie Mellon University  
5000 Forbes Avenue  
Pittsburgh, PA 15213-3890

(412) 268-4387, fax: (412) 268-7395  
tech-transfer@andrew.cmu.edu

4. Redistributions of any form whatsoever must retain the following acknowledgment: "This product includes software developed by Computing Services at Carnegie Mellon University (<http://www.cmu.edu/computing/>)."

CARNEGIE MELLON UNIVERSITY DISCLAIMS ALL WARRANTIES WITH REGARD TO HIS SOFTWARE, INCLUDING ALL IMPLIED WARRANTIES OF MERCHANTABILITY AND FITNESS, IN NO EVENT SHALL CARNEGIE MELLON UNIVERSITY BE LIABLE FOR ANY SPECIAL, INDIRECT OR CONSEQUENTIAL DAMAGES OR ANY DAMAGES WHATSOEVER RESULTING FROM LOSS OF USE, DATA OR PROFITS, WHETHER IN AN ACTION OF CONTRACT, NEGLIGENCE OR OTHER TORTIOUS ACTION, ARISING OUT OF OR IN CONNECTION WITH THE USE OR PERFORMANCE OF THIS SOFTWARE.

---

---

## OpenSSL statements

---

### OpenSSL License

Copyright (c) 1998-2019 The OpenSSL Project. All rights reserved.

Redistribution and use in source and binary forms, with or without modification, are permitted provided that the following conditions are met:

1. Redistributions of source code must retain the above copyright notice, this list of conditions and the following disclaimer.
2. Redistributions in binary form must reproduce the above copyright notice, this list of conditions and the following disclaimer in the documentation and/or other materials provided with the distribution.
3. All advertising materials mentioning features or use of this software must display the following acknowledgment: "This product includes software developed by the OpenSSL Project for use in the OpenSSL Toolkit. (<http://www.openssl.org/>)"
4. The names "OpenSSL Toolkit" and "OpenSSL Project" must not be used to endorse or promote products derived from this software without prior written permission. For written permission, please contact [opensslcore@openssl.org](mailto:opensslcore@openssl.org).
5. Products derived from this software may not be called "OpenSSL" nor may "OpenSSL" appear in their names without prior written permission of the OpenSSL Project.
6. Redistributions of any form whatsoever must retain the following acknowledgment: "This product includes software developed by the OpenSSL Project for use in the OpenSSL Toolkit (<http://www.openssl.org/>)"

THIS SOFTWARE IS PROVIDED BY THE OpenSSL PROJECT "AS IS" AND ANY EXPRESSED OR IMPLIED WARRANTIES, INCLUDING, BUT NOT LIMITED TO, THE IMPLIED WARRANTIES OF MERCHANTABILITY AND FITNESS FOR A PARTICULAR PURPOSE ARE DISCLAIMED. IN NO EVENT SHALL THE OpenSSL PROJECT OR ITS CONTRIBUTORS BE LIABLE FOR ANY DIRECT, INDIRECT, INCIDENTAL, SPECIAL, EXEMPLARY, OR CONSEQUENTIAL DAMAGES (INCLUDING, BUT NOT LIMITED TO, PROCUREMENT OF SUBSTITUTE GOODS OR SERVICES; LOSS OF USE, DATA, OR PROFITS; OR BUSINESS INTERRUPTION) HOWEVER CAUSED AND ON ANY THEORY OF LIABILITY, WHETHER IN CONTRACT, STRICT LIABILITY, OR TORT (INCLUDING NEGLIGENCE OR OTHERWISE) ARISING IN ANY WAY OUT OF THE USE OF THIS SOFTWARE, EVEN IF ADVISED OF THE POSSIBILITY OF SUCH DAMAGE.

This product includes cryptographic software written by Eric Young ([eay@cryptsoft.com](mailto:eay@cryptsoft.com)).

This product includes software written by Tim Hudson ([tjh@cryptsoft.com](mailto:tjh@cryptsoft.com)).

---

### Original SSLeay License

Copyright (c) 1995-1998 Eric Young ([eay@cryptsoft.com](mailto:eay@cryptsoft.com)) All rights reserved.

This package is an SSL implementation written by Eric Young ([eay@cryptsoft.com](mailto:eay@cryptsoft.com)). The implementation was written so as to conform with Netscapes SSL.



.....

This library is free for commercial and non-commercial use as long as the following conditions are adhered to. The following conditions apply to all code found in this distribution, be it the RC4, RSA, lhash, DES, etc., code; not just the SSL code. The SSL documentation included with this distribution is covered by the same copyright terms except that the holder is Tim Hudson (tjh@cryptsoft.com).

Copyright remains Eric Young's, and as such any Copyright notices in the code are not to be removed. If this package is used in a product, Eric Young should be given attribution as the author of the parts of the library used. This can be in the form of a textual message at program startup or in documentation (online or textual) provided with the package.

Redistribution and use in source and binary forms, with or without modification, are permitted provided that the following conditions are met:

1. Redistributions of source code must retain the copyright notice, this list of conditions and the following disclaimer.
2. Redistributions in binary form must reproduce the above copyright notice, this list of conditions and the following disclaimer in the documentation and/or other materials provided with the distribution.
3. All advertising materials mentioning features or use of this software must display the following acknowledgement: "This product includes cryptographic software written by Eric Young (eay@cryptsoft.com)" The word 'cryptographic' can be left out if the routines from the library being used are not cryptographic related :-).
4. If you include any Windows specific code (or a derivative thereof) from the apps directory (application code) you must include an acknowledgement: "This product includes software written by Tim Hudson (tjh@cryptsoft.com)"

THIS SOFTWARE IS PROVIDED BY ERIC YOUNG "AS IS" AND ANY EXPRESS OR IMPLIED WARRANTIES, INCLUDING, BUT NOT LIMITED TO, THE IMPLIED WARRANTIES OF MERCHANTABILITY AND FITNESS FOR A PARTICULAR PURPOSE ARE DISCLAIMED. IN NO EVENT SHALL THE AUTHOR OR CONTRIBUTORS BE LIABLE FOR ANY DIRECT, INDIRECT, INCIDENTAL, SPECIAL, EXEMPLARY, OR CONSEQUENTIAL DAMAGES (INCLUDING, BUT NOT LIMITED TO, PROCUREMENT OF SUBSTITUTE GOODS OR SERVICES; LOSS OF USE, DATA, OR PROFITS; OR BUSINESS INTERRUPTION) HOWEVER CAUSED AND ON ANY THEORY OF LIABILITY, WHETHER IN CONTRACT, STRICT LIABILITY, OR TORT (INCLUDING NEGLIGENCE OR OTHERWISE) ARISING IN ANY WAY OUT OF THE USE OF THIS SOFTWARE, EVEN IF ADVISED OF THE POSSIBILITY OF SUCH DAMAGE.

The licence and distribution terms for any publically available version or derivative of this code cannot be changed. i.e. this code cannot simply be copied and put under another distribution licence [including the GNU Public Licence.]

---

---

## OpenLDAP Statements

---

This product includes software developed by the OpenLDAP Project.

Unless otherwise expressly stated herein, The OpenLDAP Public License Version 2.8 shall be applied to individual files.

Copyright 1998-2007 The OpenLDAP Foundation All rights reserved.

Redistribution and use in source and binary forms, with or without modification, are permitted only as authorized by the OpenLDAP Public License.

A copy of this license is available in the file LICENSE in the top-level directory of the distribution or, alternatively, at <http://www.OpenLDAP.org/license.html>.

Portions Copyright 1999 Lars Uffmann.

All rights reserved.

Redistribution and use in source and binary forms, with or without modification, are permitted only as authorized by the OpenLDAP Public License.

Portions Copyright (c) 1990, 1993-1996 Regents of the University of Michigan. All rights reserved.

Redistribution and use in source and binary forms are permitted provided that this notice is preserved and that due credit is given to the University of Michigan at Ann Arbor. The name of the University may not be used to endorse or promote products derived from this software without specific prior written permission. This software is provided "as is" without express or implied warranty.

Portions Copyright (c) 1999, 2000 Novell, Inc. All Rights Reserved.

THIS WORK IS SUBJECT TO U.S. AND INTERNATIONAL COPYRIGHT LAWS AND TREATIES. USE, MODIFICATION, AND REDISTRIBUTION OF THIS WORK IS SUBJECT TO VERSION 2.0.1 OF THE OPENLDAP PUBLIC LICENSE, A COPY OF WHICH IS AVAILABLE AT [HTTP://WWW.OPENLDAP.ORG/LICENSE.HTML](http://www.openldap.org/license.html) OR IN THE FILE "LICENSE" IN THE TOP-LEVEL DIRECTORY OF THE DISTRIBUTION. ANY USE OR EXPLOITATION OF THIS WORK OTHER THAN AS AUTHORIZED IN VERSION 2.0.1 OF THE OPENLDAP PUBLIC LICENSE, OR OTHER PRIOR WRITTEN CONSENT FROM NOVELL, COULD SUBJECT THE PERPETRATOR TO CRIMINAL AND CIVIL LIABILITY.

Portions Copyright (c) The Internet Society (1997).

See RFC 2251 for full legal notices.

---

The OpenLDAP Public License Version 2.8, 17 August 2003

Redistribution and use of this software and associated documentation ("Software"), with or without modification, are permitted provided that the following conditions are met:

1. Redistributions in source form must retain copyright statements and notices,
2. Redistributions in binary form must reproduce applicable copyright statements and notices, this list of conditions, and the following disclaimer in the documentation and/or other materials provided with the distribution, and
3. Redistributions must contain a verbatim copy of this document.

The OpenLDAP Foundation may revise this license from time to time. Each revision is distinguished by a version number. You may use this Software under terms of this license revision or under the terms of any subsequent revision of the license.

THIS SOFTWARE IS PROVIDED BY THE OPENLDAP FOUNDATION AND ITS CONTRIBUTORS "AS IS" AND ANY EXPRESSED OR IMPLIED WARRANTIES, INCLUDING, BUT NOT LIMITED TO, THE IMPLIED WARRANTIES OF MERCHANTABILITY AND FITNESS FOR A PARTICULAR PURPOSE ARE DISCLAIMED. IN NO EVENT SHALL THE OPENLDAP FOUNDATION, ITS CONTRIBUTORS, OR THE AUTHOR(S) OR OWNER(S) OF THE SOFTWARE BE LIABLE FOR ANY DIRECT, INDIRECT, INCIDENTAL, SPECIAL, EXEMPLARY, OR CONSEQUENTIAL DAMAGES (INCLUDING, BUT NOT LIMITED TO, PROCUREMENT OF SUBSTITUTE GOODS OR SERVICES; LOSS OF USE, DATA, OR PROFITS; OR BUSINESS INTERRUPTION) HOWEVER CAUSED AND ON ANY THEORY OF LIABILITY, WHETHER IN CONTRACT, STRICT LIABILITY, OR TORT (INCLUDING NEGLIGENCE OR OTHERWISE) ARISING IN ANY WAY OUT OF THE USE OF THIS SOFTWARE, EVEN IF ADVISED OF THE POSSIBILITY OF SUCH DAMAGE.

The names of the authors and copyright holders must not be used in advertising or otherwise to promote the sale, use or other dealing in this Software without specific, written prior permission. Title to copyright in this Software shall at all times remain with copyright holders.

OpenLDAP is a registered trademark of the OpenLDAP Foundation. Copyright 1999-2003 The OpenLDAP Foundation, Redwood City, California, USA. All Rights Reserved.

Permission to copy and distribute verbatim copies of this document is granted.

A number of files contained in OpenLDAP Software contain a statement:

USE, MODIFICATION, AND REDISTRIBUTION OF THIS WORK IS SUBJECT TO VERSION 2.0.1 OF THE OPENLDAP PUBLIC LICENSE, A COPY OF WHICH IS AVAILABLE AT [HTTP://WWW.OPENLDAP.ORG/LICENSE.HTML](http://www.openldap.org/license.html) OR IN THE FILE "LICENSE" IN THE TOP-LEVEL DIRECTORY OF THE DISTRIBUTION.

The following is a verbatim copy of version 2.0.1 of the OpenLDAP Public License referenced in the above statement.

---

The OpenLDAP Public License

Version 2.0.1, 21 December 1999

Copyright 1999, The OpenLDAP Foundation, Redwood City, California, USA. All Rights Reserved.

Redistribution and use of this software and associated documentation ("Software"), with or without modification, are permitted provided that the following conditions are met:

1. Redistributions of source code must retain copyright statements and notices. Redistributions must also contain a copy of this document.

2. Redistributions in binary form must reproduce the above copyright notice, this list of conditions and the following disclaimer in the documentation and/or other materials provided with the distribution.
3. The name "OpenLDAP" must not be used to endorse or promote products derived from this Software without prior written permission of the OpenLDAP Foundation. For written permission, please contact [foundation@openldap.org](mailto:foundation@openldap.org).
4. Products derived from this Software may not be called "OpenLDAP" nor may "OpenLDAP" appear in their names without prior written permission of the OpenLDAP Foundation. OpenLDAP is a trademark of the OpenLDAP Foundation.
5. Due credit should be given to the OpenLDAP Project (<http://www.openldap.org/>).

THIS SOFTWARE IS PROVIDED BY THE OPENLDAP FOUNDATION AND CONTRIBUTORS "AS IS" AND ANY EXPRESSED OR IMPLIED WARRANTIES, INCLUDING, BUT NOT LIMITED TO, THE IMPLIED WARRANTIES OF MERCHANTABILITY AND FITNESS FOR A PARTICULAR PURPOSE ARE DISCLAIMED. IN NO EVENT SHALL THE OPENLDAP FOUNDATION OR ITS CONTRIBUTORS BE LIABLE FOR ANY DIRECT, INDIRECT, INCIDENTAL, SPECIAL, EXEMPLARY, OR CONSEQUENTIAL DAMAGES (INCLUDING, BUT NOT LIMITED TO, PROCUREMENT OF SUBSTITUTE GOODS OR SERVICES; LOSS OF USE, DATA, OR PROFITS; OR BUSINESS INTERRUPTION) HOWEVER CAUSED AND ON ANY THEORY OF LIABILITY, WHETHER IN CONTRACT, STRICT LIABILITY, OR TORT (INCLUDING NEGLIGENCE OR OTHERWISE) ARISING IN ANY WAY OUT OF THE USE OF THIS SOFTWARE, EVEN IF ADVISED OF THE POSSIBILITY OF SUCH DAMAGE.

---

RFC 2251 Full Copyright Statement

Copyright (c) The Internet Society (1997). All Rights Reserved.

This document and translations of it may be copied and furnished to others, and derivative works that comment on or otherwise explain it or assist in its implementation may be prepared, copied, published and distributed, in whole or in part, without restriction of any kind, provided that the above copyright notice and this paragraph are included on all such copies and derivative works. However, this document itself may not be modified in any way, such as by removing the copyright notice or references to the Internet Society or other Internet organizations, except as needed for the purpose of developing Internet standards in which case the procedures for copyrights defined in the Internet Standards process must be followed, or as required to translate it into languages other than English.

The limited permissions granted above are perpetual and will not be revoked by the Internet Society or its successors or assigns.

This document and the information contained herein is provided on an "AS IS" basis and THE INTERNET SOCIETY AND THE INTERNET ENGINEERING TASK FORCE DISCLAIMS ALL WARRANTIES, EXPRESS OR IMPLIED, INCLUDING BUT NOT LIMITED TO ANY WARRANTY THAT THE USE OF THE INFORMATION HEREIN WILL NOT INFRINGE ANY RIGHTS OR ANY IMPLIED WARRANTIES OF MERCHANTABILITY OR FITNESS FOR A PARTICULAR PURPOSE.



=====  
Libtiff Copyright and License

Use and Copyright

Copyright (c) 1988-1997 Sam Leffler  
Copyright (c) 1991-1997 Silicon Graphics, Inc.

Permission to use, copy, modify, distribute, and sell this software and its documentation for any purpose is hereby granted without fee, provided that (i) the above copyright notices and this permission notice appear in all copies of the software and related documentation, and (ii) the names of Sam Leffler and Silicon Graphics may not be used in any advertising or publicity relating to the software without the specific, prior written permission of Sam Leffler and Silicon Graphics.

THE SOFTWARE IS PROVIDED "AS-IS" AND WITHOUT WARRANTY OF ANY KIND, EXPRESS, IMPLIED OR OTHERWISE, INCLUDING WITHOUT LIMITATION, ANY WARRANTY OF MERCHANTABILITY OR FITNESS FOR A PARTICULAR PURPOSE.

IN NO EVENT SHALL SAM LEFFLER OR SILICON GRAPHICS BE LIABLE FOR ANY SPECIAL, INCIDENTAL, INDIRECT OR CONSEQUENTIAL DAMAGES OF ANY KIND, OR ANY DAMAGES WHATSOEVER RESULTING FROM LOSS OF USE, DATA OR PROFITS, WHETHER OR NOT ADVISED OF THE POSSIBILITY OF DAMAGE, AND ON ANY THEORY OF LIABILITY, ARISING OUT OF OR IN CONNECTION WITH THE USE OR PERFORMANCE OF THIS SOFTWARE.



libjpeg

this software is based in part on the work of the Independent JPEG Group

=====  
libpng

This copy of the libpng notices is provided for your convenience. In case of any discrepancy between this copy and the notices in the file png.h that is included in the libpng distribution, the latter shall prevail.

COPYRIGHT NOTICE, DISCLAIMER, and LICENSE:

If you modify libpng you may insert additional notices immediately following this sentence.

This code is released under the libpng license.

libpng versions 1.2.6, August 15, 2004, through 1.6.2, April 25, 2013, are Copyright (c) 2004, 2006-2012 Glenn Randers-Pehrson, and are distributed according to the same disclaimer and license as libpng-1.2.5 with the following individual added to the list of Contributing Authors

Cosmin Truta

libpng versions 1.0.7, July 1, 2000, through 1.2.5 - October 3, 2002, are Copyright (c) 2000-2002 Glenn Randers-Pehrson, and are distributed according to the same disclaimer and license as libpng-1.0.6 with the following individuals added to the list of Contributing Authors

Simon-Pierre Cadieux  
Eric S. Raymond  
Gilles Vollant

and with the following additions to the disclaimer:

There is no warranty against interference with your enjoyment of the library or against infringement. There is no warranty that our efforts or the library will fulfill any of your particular purposes or needs. This library is provided with all faults, and the entire risk of satisfactory quality, performance, accuracy, and effort is with the user.

libpng versions 0.97, January 1998, through 1.0.6, March 20, 2000, are Copyright (c) 1998, 1999 Glenn Randers-Pehrson, and are distributed according to the same disclaimer and license as libpng-0.96, with the following individuals added to the list of Contributing Authors:

Tom Lane  
Glenn Randers-Pehrson  
Willem van Schaik

libpng versions 0.89, June 1996, through 0.96, May 1997, are Copyright (c) 1996, 1997 Andreas Dilger  
Distributed according to the same disclaimer and license as libpng-0.88,



with the following individuals added to the list of Contributing Authors:

John Bowler  
Kevin Bracey  
Sam Bushell  
Magnus Holmgren  
Greg Roelofs  
Tom Tanner

libpng versions 0.5, May 1995, through 0.88, January 1996, are  
Copyright (c) 1995, 1996 Guy Eric Schalnat, Group 42, Inc.

For the purposes of this copyright and license, "Contributing Authors"  
is defined as the following set of individuals:

Andreas Dilger  
Dave Martindale  
Guy Eric Schalnat  
Paul Schmidt  
Tim Wegner

The PNG Reference Library is supplied "AS IS". The Contributing Authors  
and Group 42, Inc. disclaim all warranties, expressed or implied,  
including, without limitation, the warranties of merchantability and of  
fitness for any purpose. The Contributing Authors and Group 42, Inc.  
assume no liability for direct, indirect, incidental, special, exemplary,  
or consequential damages, which may result from the use of the PNG  
Reference Library, even if advised of the possibility of such damage.

Permission is hereby granted to use, copy, modify, and distribute this  
source code, or portions hereof, for any purpose, without fee, subject  
to the following restrictions:

1. The origin of this source code must not be misrepresented.
2. Altered versions must be plainly marked as such and must not  
be misrepresented as being the original source.
3. This Copyright notice may not be removed or altered from any  
source or altered source distribution.

The Contributing Authors and Group 42, Inc. specifically permit, without  
fee, and encourage the use of this source code as a component to  
supporting the PNG file format in commercial products. If you use this  
source code in a product, acknowledgment is not required but would be  
appreciated.

A "png\_get\_copyright" function is available, for convenient use in "about"  
boxes and the like:

```
printf("%s",png_get_copyright(NULL));
```

Also, the PNG logo (in PNG format, of course) is supplied in the files "pngbar.png" and "pngbar.jpg (88x31) and "pngnow.png" (98x31).

Libpng is OSI Certified Open Source Software. OSI Certified Open Source is a certification mark of the Open Source Initiative.

Glenn Randers-Pehrson  
glennrp at users.sourceforge.net  
April 25, 2013

=====  
libstrophe

Copyright (c) 2005-2009 Collecta, Inc.

Permission is hereby granted, free of charge, to any person obtaining a copy of this software and associated documentation files (the "Software"), to deal in the Software without restriction, including without limitation the rights to use, copy, modify, merge, publish, distribute, sublicense, and/or sell copies of the Software, and to permit persons to whom the Software is furnished to do so, subject to the following conditions:

The above copyright notice and this permission notice shall be included in all copies or substantial portions of the Software.

THE SOFTWARE IS PROVIDED "AS IS", WITHOUT WARRANTY OF ANY KIND, EXPRESS OR IMPLIED, INCLUDING BUT NOT LIMITED TO THE WARRANTIES OF MERCHANTABILITY, FITNESS FOR A PARTICULAR PURPOSE AND NONINFRINGEMENT. IN NO EVENT SHALL THE AUTHORS OR COPYRIGHT HOLDERS BE LIABLE FOR ANY CLAIM, DAMAGES OR OTHER LIABILITY, WHETHER IN AN ACTION OF CONTRACT, TORT OR OTHERWISE, ARISING FROM, OUT OF OR IN CONNECTION WITH THE SOFTWARE OR THE USE OR OTHER DEALINGS IN THE SOFTWARE.

=====

json-c

Copyright (c) 2004, 2005 Metaparadigm Pte Ltd

Permission is hereby granted, free of charge, to any person obtaining a copy of this software and associated documentation files (the "Software"), to deal in the Software without restriction, including without limitation the rights to use, copy, modify, merge, publish, distribute, sublicense, and/or sell copies of the Software, and to permit persons to whom the Software is furnished to do so, subject to the following conditions:

The above copyright notice and this permission notice shall be included in all copies or substantial portions of the Software.

THE SOFTWARE IS PROVIDED "AS IS", WITHOUT WARRANTY OF ANY KIND, EXPRESS OR IMPLIED, INCLUDING BUT NOT LIMITED TO THE WARRANTIES OF MERCHANTABILITY, FITNESS FOR A PARTICULAR PURPOSE AND NONINFRINGEMENT. IN NO EVENT SHALL THE AUTHORS OR COPYRIGHT HOLDERS BE LIABLE FOR ANY CLAIM, DAMAGES OR OTHER LIABILITY, WHETHER IN AN ACTION OF CONTRACT, TORT OR OTHERWISE, ARISING FROM, OUT OF OR IN CONNECTION WITH THE SOFTWARE OR THE USE OR OTHER DEALINGS IN THE SOFTWARE.

---

---

## Open SSH

This file is part of the OpenSSH software.

The licences which components of this software fall under are as follows.  
that all components are under a BSD licence, or a licence more free than that.

First, we will summarize and say

OpenSSH contains no GPL code.

1)

- \* Copyright (c) 1995 Tatu Ylonen <ylo@cs.hut.fi>, Espoo, Finland
- \* All rights reserved
- \*
- \* As far as I am concerned, the code I have written for this software
- \* can be used freely for any purpose. Any derived versions of this
- \* software must be clearly marked as such, and if the derived work is
- \* incompatible with the protocol description in the RFC file, it must be
- \* called by a name other than "ssh" or "Secure Shell".

[Tatu continues]

- \* However, I am not implying to give any licenses to any patents or
- \* copyrights held by third parties, and the software includes parts that
- \* are not under my direct control. As far as I know, all included
- \* source code is used in accordance with the relevant license agreements
- \* and can be used freely for any purpose (the GNU license being the most
- \* restrictive); see below for details.

[However, none of that term is relevant at this point in time. All of these restrictively licenced software components which he talks about have been removed from OpenSSH, i.e.,

- RSA is no longer included, found in the OpenSSL library
- IDEA is no longer included, its use is deprecated
- DES is now external, in the OpenSSL library
- GMP is no longer used, and instead we call BN code from OpenSSL
- Zlib is now external, in a library
- The make-ssh-known-hosts script is no longer included
- TSS has been removed
- MD5 is now external, in the OpenSSL library
- RC4 support has been replaced with ARC4 support from OpenSSL
- Blowfish is now external, in the OpenSSL library

[The licence continues]

Note that any information and cryptographic algorithms used in this software are publicly available on the Internet and at any major bookstore, scientific library, and patent office worldwide. More information can be found e.g. at "<http://www.cs.hut.fi/crypto>".

The legal status of this program is some combination of all these permissions and restrictions. Use only at your own responsibility. You will be responsible for any legal consequences yourself; I am not making any

claims whether possessing or using this is legal or not in your country, and I am not taking any responsibility on your behalf.

#### NO WARRANTY

BECAUSE THE PROGRAM IS LICENSED FREE OF CHARGE, THERE IS NO WARRANTY FOR THE PROGRAM, TO THE EXTENT PERMITTED BY APPLICABLE LAW. EXCEPT WHEN OTHERWISE STATED IN WRITING THE COPYRIGHT HOLDERS AND/OR OTHER PARTIES PROVIDE THE PROGRAM "AS IS" WITHOUT WARRANTY OF ANY KIND, EITHER EXPRESSED OR IMPLIED, INCLUDING, BUT NOT LIMITED TO, THE IMPLIED WARRANTIES OF MERCHANTABILITY AND FITNESS FOR A PARTICULAR PURPOSE. THE ENTIRE RISK AS

TO THE QUALITY AND PERFORMANCE OF THE PROGRAM IS WITH YOU. SHOULD THE PROGRAM PROVE DEFECTIVE, YOU ASSUME THE COST OF ALL NECESSARY SERVICING, REPAIR OR CORRECTION.

IN NO EVENT UNLESS REQUIRED BY APPLICABLE LAW OR AGREED TO IN WRITING WILL ANY COPYRIGHT HOLDER, OR ANY OTHER PARTY WHO MAY MODIFY AND/OR REDISTRIBUTE THE PROGRAM AS PERMITTED ABOVE, BE LIABLE TO YOU FOR DAMAGES, INCLUDING ANY GENERAL, SPECIAL, INCIDENTAL OR CONSEQUENTIAL DAMAGES ARISING OUT OF THE USE OR INABILITY TO USE THE PROGRAM (INCLUDING BUT NOT LIMITED TO LOSS OF DATA OR DATA BEING RENDERED INACCURATE OR LOSSES SUSTAINED BY YOU OR THIRD PARTIES OR A FAILURE OF THE PROGRAM TO OPERATE WITH ANY OTHER PROGRAMS), EVEN IF SUCH HOLDER OR OTHER PARTY HAS BEEN ADVISED OF THE POSSIBILITY OF SUCH DAMAGES.

4)

The Rijndael implementation by Vincent Rijmen, Antoon Bosselaers and Paulo Barreto is in the public domain and distributed with the following license:

- \* @version 3.0 (December 2000)
- \*
- \* Optimised ANSI C code for the Rijndael cipher (now AES)
- \*
- \* @author Vincent Rijmen <vincent.rijmen@esat.kuleuven.ac.be>
- \* @author Antoon Bosselaers <antoon.bosselaers@esat.kuleuven.ac.be>
- \* @author Paulo Barreto <paulo.barreto@terra.com.br>
- \*
- \* This code is hereby placed in the public domain.
- \*
- \* THIS SOFTWARE IS PROVIDED BY THE AUTHORS "AS IS" AND ANY EXPRESS
- \* OR IMPLIED WARRANTIES, INCLUDING, BUT NOT LIMITED TO, THE IMPLIED
- \* WARRANTIES OF MERCHANTABILITY AND FITNESS FOR A PARTICULAR PURPOSE
- \* ARE DISCLAIMED. IN NO EVENT SHALL THE AUTHORS OR CONTRIBUTORS BE
- \* LIABLE FOR ANY DIRECT, INDIRECT, INCIDENTAL, SPECIAL, EXEMPLARY, OR
- \* CONSEQUENTIAL DAMAGES (INCLUDING, BUT NOT LIMITED TO, PROCUREMENT OF
- \* SUBSTITUTE GOODS OR SERVICES; LOSS OF USE, DATA, OR PROFITS;
- OR

- \* BUSINESS INTERRUPTION) HOWEVER CAUSED AND ON ANY THEORY OF LIABILITY,
- \* WHETHER IN CONTRACT, STRICT LIABILITY, OR TORT (INCLUDING NEGLIGENCE
- \* OR OTHERWISE) ARISING IN ANY WAY OUT OF THE USE OF THIS SOFTWARE,
- \* EVEN IF ADVISED OF THE POSSIBILITY OF SUCH DAMAGE.

5)

One component of the ssh source code is under a 3-clause BSD license, held by the University of California, since we pulled these parts from original Berkeley code.

- \* Copyright (c) 1983, 1990, 1992, 1993, 1995
- \* The Regents of the University of California. All rights reserved.
- \*
- \* Redistribution and use in source and binary forms, with or without
- \* modification, are permitted provided that the following conditions
- \* are met:
- \* 1. Redistributions of source code must retain the above copyright
- \* notice, this list of conditions and the following disclaimer.
- \* 2. Redistributions in binary form must reproduce the above copyright
- \* notice, this list of conditions and the following disclaimer in the
- \* documentation and/or other materials provided with the distribution.
- \* 3. Neither the name of the University nor the names of its contributors
- \* may be used to endorse or promote products derived from this software
- \* without specific prior written permission.
- \*
- \* THIS SOFTWARE IS PROVIDED BY THE REGENTS AND CONTRIBUTORS
- \* ``AS IS" AND
- \* ANY EXPRESS OR IMPLIED WARRANTIES, INCLUDING, BUT NOT LIMITED TO, THE
- \* IMPLIED WARRANTIES OF MERCHANTABILITY AND FITNESS FOR A PARTICULAR PURPOSE
- \* ARE DISCLAIMED. IN NO EVENT SHALL THE REGENTS OR CONTRIBUTORS BE LIABLE
- \* FOR ANY DIRECT, INDIRECT, INCIDENTAL, SPECIAL, EXEMPLARY, OR CONSEQUENTIAL
- \* DAMAGES (INCLUDING, BUT NOT LIMITED TO, PROCUREMENT OF SUBSTITUTE GOODS
- \* OR SERVICES; LOSS OF USE, DATA, OR PROFITS; OR BUSINESS INTERRUPTION)
- \* HOWEVER CAUSED AND ON ANY THEORY OF LIABILITY, WHETHER IN CONTRACT, STRICT
- \* LIABILITY, OR TORT (INCLUDING NEGLIGENCE OR OTHERWISE) ARISING IN ANY WAY
- \* OUT OF THE USE OF THIS SOFTWARE, EVEN IF ADVISED OF THE POSSIBILITY OF
- \* SUCH DAMAGE.

6)

Remaining components of the software are provided under a standard 2-term BSD licence with the following names as copyright holders:

Markus Friedl  
Theo de Raadt  
Niels Provos  
Dug Song  
Aaron Campbell  
Damien Miller  
Kevin Steves  
Daniel Kouril

Wesley Griffin  
Per Allansson  
Nils Nordman  
Simon Wilkinson

- \* Redistribution and use in source and binary forms, with or without
- \* modification, are permitted provided that the following conditions
- \* are met:
- \* 1. Redistributions of source code must retain the above copyright
- \* notice, this list of conditions and the following disclaimer.
- \* 2. Redistributions in binary form must reproduce the above copyright
- \* notice, this list of conditions and the following disclaimer in the
- \* documentation and/or other materials provided with the distribution.
- \*
- \* THIS SOFTWARE IS PROVIDED BY THE AUTHOR ``AS IS" AND ANY EXPRESS OR
- \* IMPLIED WARRANTIES, INCLUDING, BUT NOT LIMITED TO, THE IMPLIED WARRANTIES
- \* OF MERCHANTABILITY AND FITNESS FOR A PARTICULAR PURPOSE ARE DISCLAIMED.
- \* IN NO EVENT SHALL THE AUTHOR BE LIABLE FOR ANY DIRECT, INDIRECT,
- \* INCIDENTAL, SPECIAL, EXEMPLARY, OR CONSEQUENTIAL DAMAGES (INCLUDING, BUT
- \* NOT LIMITED TO, PROCUREMENT OF SUBSTITUTE GOODS OR SERVICES; LOSS OF USE,
- \* DATA, OR PROFITS; OR BUSINESS INTERRUPTION) HOWEVER CAUSED AND ON ANY
- \* THEORY OF LIABILITY, WHETHER IN CONTRACT, STRICT LIABILITY, OR
- TORT
- \* (INCLUDING NEGLIGENCE OR OTHERWISE) ARISING IN ANY WAY OUT OF THE USE OF
- \* THIS SOFTWARE, EVEN IF ADVISED OF THE POSSIBILITY OF SUCH DAMAGE.

-----  
\$OpenBSD: LICENCE,v 1.19 2004/08/30 09:18:08 markus Exp \$



---

---

Open NFC

Copyright (c) 2007-2010 Inside Secure, All Rights Reserved.

Licensed under the Apache License, Version 2.0 (the "License"); you may not use this file except in compliance with the License.

You may obtain a copy of the License at

<http://www.apache.org/licenses/LICENSE-2.0>

Unless required by applicable law or agreed to in writing, software distributed under the License is distributed on an "AS IS" BASIS, WITHOUT WARRANTIES OR CONDITIONS OF ANY KIND, either express or implied.

See the License for the specific language governing permissions and limitations under the License.

.....  
=====

linux\_libnfc-nci

The original Work has been changed by NXP Semiconductors.

Copyright (C) 2015 NXP Semiconductors

Licensed under the Apache License, Version 2.0 (the "License"); you may not use this file except in compliance with the License. You may obtain a copy of the License at

<http://www.apache.org/licenses/LICENSE-2.0>

Unless required by applicable law or agreed to in writing, software distributed under the License is distributed on an "AS IS" BASIS, WITHOUT WARRANTIES OR CONDITIONS OF ANY KIND, either express or implied.

See the License for the specific language governing permissions and limitations under the License.

=====  
Lua

Permission is hereby granted, free of charge, to any person obtaining a copy of this software and associated documentation files (the "Software"), to deal in the Software without restriction, including without limitation the rights to use, copy, modify, merge, publish, distribute, sublicense, and/or sell copies of the Software, and to permit persons to whom the Software is furnished to do so, subject to the following conditions:

The above copyright notice and this permission notice shall be included in all copies or substantial portions of the Software.

THE SOFTWARE IS PROVIDED "AS IS", WITHOUT WARRANTY OF ANY KIND, EXPRESS OR IMPLIED, INCLUDING BUT NOT LIMITED TO THE WARRANTIES OF MERCHANTABILITY, FITNESS FOR A PARTICULAR PURPOSE AND NONINFRINGEMENT. IN NO EVENT SHALL THE AUTHORS OR COPYRIGHT HOLDERS BE LIABLE FOR ANY CLAIM, DAMAGES OR OTHER LIABILITY, WHETHER IN AN ACTION OF CONTRACT, TORT OR OTHERWISE, ARISING FROM, OUT OF OR IN CONNECTION WITH THE SOFTWARE OR THE USE OR OTHER DEALINGS IN THE SOFTWARE.

=====  
USB Host Driver (in FreeBSD)

Copyright (c) 1992-2013 The FreeBSD Project. All rights reserved.

Redistribution and use in source and binary forms, with or without modification, are permitted provided that the following conditions are met:

1. Redistributions of source code must retain the above copyright notice, this list of conditions and the following disclaimer.
2. Redistributions in binary form must reproduce the above copyright notice, this list of conditions and the following disclaimer in the documentation and/or other materials provided with the distribution.

THIS SOFTWARE IS PROVIDED BY THE AUTHOR AND CONTRIBUTORS ``AS IS" AND ANY EXPRESS OR IMPLIED WARRANTIES, INCLUDING, BUT NOT LIMITED TO, THE IMPLIED WARRANTIES OF MERCHANTABILITY AND FITNESS FOR A PARTICULAR PURPOSE ARE DISCLAIMED. IN NO EVENT SHALL THE AUTHOR OR CONTRIBUTORS BE LIABLE FOR ANY DIRECT, INDIRECT, INCIDENTAL, SPECIAL, EXEMPLARY, OR CONSEQUENTIAL DAMAGES (INCLUDING, BUT NOT LIMITED TO, PROCUREMENT OF SUBSTITUTE GOODS OR SERVICES; LOSS OF USE, DATA, OR PROFITS; OR BUSINESS INTERRUPTION) HOWEVER CAUSED AND ON ANY THEORY OF LIABILITY, WHETHER IN CONTRACT, STRICT LIABILITY, OR TORT (INCLUDING NEGLIGENCE OR OTHERWISE) ARISING IN ANY WAY OUT OF THE USE OF THIS SOFTWARE, EVEN IF ADVISED OF THE POSSIBILITY OF SUCH DAMAGE.

=====

mDNSResponder

Copyright (c) 2002-2013 Apple Computer, Inc. All rights reserved.

Licensed under the Apache License, Version 2.0 (the "License"); you may not use this file except in compliance with the License. You may obtain a copy of the License at

<http://www.apache.org/licenses/LICENSE-2.0>

Unless required by applicable law or agreed to in writing, software distributed under the License is distributed on an "AS IS" BASIS,

WITHOUT WARRANTIES OR CONDITIONS OF ANY KIND, either express or implied.

See the License for the specific language governing permissions and limitations under the License.

=====

wpa\_supplicant and hostapd

Copyright (c) 2002-2014, Jouni Malinen <j@w1.fi> and contributors All Rights Reserved.

These programs are licensed under the BSD license (the one with advertisement clause removed).

If you are submitting changes to the project, please see CONTRIBUTIONS file for more instructions.

This package may include either wpa\_supplicant, hostapd, or both. See README file respective subdirectories (wpa\_supplicant/README or hostapd/README) for more details.

Source code files were moved around in v0.6.x releases and compared to earlier releases, the programs are now built by first going to a subdirectory (wpa\_supplicant or hostapd) and creating build configuration (.config) and running 'make' there (for Linux/BSD/cygwin builds).

License

-----

This software may be distributed, used, and modified under the terms of BSD license:

Redistribution and use in source and binary forms, with or without modification, are permitted provided that the following conditions are met:

1. Redistributions of source code must retain the above copyright notice, this list of conditions and the following disclaimer.
2. Redistributions in binary form must reproduce the above copyright notice, this list of conditions and the following disclaimer in the documentation and/or other materials provided with the distribution.
3. Neither the name(s) of the above-listed copyright holder(s) nor the names of its contributors may be used to endorse or promote products derived from this software without specific prior written permission.

THIS SOFTWARE IS PROVIDED BY THE COPYRIGHT HOLDERS AND CONTRIBUTORS "AS IS" AND ANY EXPRESS OR IMPLIED WARRANTIES, INCLUDING, BUT NOT LIMITED TO, THE IMPLIED WARRANTIES OF MERCHANTABILITY AND FITNESS FOR A PARTICULAR PURPOSE ARE DISCLAIMED. IN NO EVENT SHALL THE COPYRIGHT OWNER OR CONTRIBUTORS BE LIABLE FOR ANY DIRECT, INDIRECT, INCIDENTAL, SPECIAL, EXEMPLARY, OR CONSEQUENTIAL DAMAGES (INCLUDING, BUT NOT LIMITED TO, PROCUREMENT OF SUBSTITUTE GOODS OR SERVICES; LOSS OF USE, DATA, OR PROFITS; OR BUSINESS INTERRUPTION) HOWEVER CAUSED AND ON ANY THEORY OF LIABILITY, WHETHER IN CONTRACT, STRICT LIABILITY, OR TORT (INCLUDING NEGLIGENCE OR OTHERWISE) ARISING IN ANY WAY OUT OF THE USE OF THIS SOFTWARE, EVEN IF ADVISED OF THE POSSIBILITY OF SUCH DAMAGE.



=====  
T-Kernel

This Product uses the Source Code of T-Kernel under T-License 2.0 granted by the T-Engine Forum ([www.tengine.org](http://www.tengine.org))



\*Please note that the contents of this manual may differ slightly from the actual product purchased as a result of product improvements.

**BROTHER INDUSTRIES, LTD.** <https://www.brother.com/>  
1-5, Kitajizoyama, Noda-cho, Kariya 448-0803, Japan.

© 2021-2022 Brother Industries, Ltd. All Rights Reserved.  
This is the original instructions.

---

GT60NB  
I2011626F EN  
2022.03.F(1)