

# Hotronix® Auto open Series 6x6 And LowRider

## OPERATOR'S MANUAL



LowRider

6x6

# Safety Instructions

When using your heat press,  
basic precautions should always be followed,  
including the following:

1. Read all instructions.
2. Use heat press only for its intended use.
3. To reduce the risk of electric shock, do not immerse the heat press in water or other liquids.
4. Never pull cord to disconnect from outlet, instead grasp plug and pull to disconnect.
5. Do not allow cord to touch hot surfaces, allow heat press to cool completely before storing.
6. Do not operate heat press with a damaged cord or if the equipment has been dropped or damaged. To reduce the risk of electric shock, do not disassemble or attempt to repair the heat press. Take it to a qualified service person for examination and repair. Incorrect assembly or repair could increase the risk of fire, electric shock, or injury to persons when the equipment is used.
7. This appliance is not intended for use by persons (including children) with reduced physical, sensory or mental capabilities, or lack of experience and knowledge, unless they have been given supervision or instruction concerning use of the appliance by a person responsible for their safety.
8. Close supervision is necessary for any heat press being used by or near children. Do not leave equipment unattended while connected.
9. Burns can occur when touching hot metal parts.
10. To reduce the likelihood of circuit overload, do not operate other high voltage equipment on the same circuit.
11. If an extension cord is necessary, then a 20 amperage rated cord should be used. Cords rated for less amperage may overheat. Care should be taken to arrange the cord so that it cannot be pulled or tripped over.

## Product Warranty Registration

Log onto [www.Hotronix.com/registration](http://www.Hotronix.com/registration)  
You must provide the Hotronix® heat press  
serial number and model information.

Machine View	4
Control Panel Guide	5
Operating Instructions	6-11
Connecting the System	6
Turning the System On	7
Adjusting the Temperature	8
Adjusting the Time	9
Adjusting the Pressure	10
Pressing	11
Replacement Parts List	12
Parts Location Guide	13
Electrical Schematic	14
Contact	15



## FRONT VIEW



LED Display

Located on the opposite side of the press

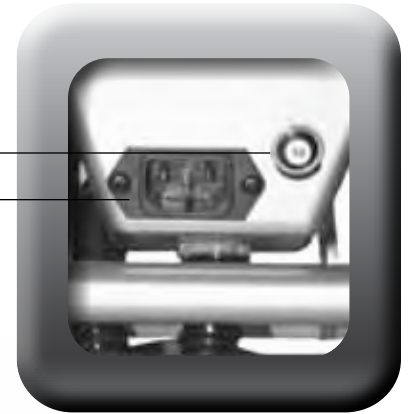

Circuit Breaker  
Power Supply

## SIDE VIEW

Lift Handle

12V Magnet

Power ON/OFF Switch

Pressure Adjustment Knob





### AUTO OPEN 6X6 AND LOWRIDER HEAT PRESS

The Auto Open 6x6/LowRider Press Operating Instructions are designed with the user in mind. Carefully read and follow the step-by-step instructions for best results.



- To avoid burns, do not touch the heated platen during use.
- Keep hands clear of the upper platen of the press during platen lock down as the pressure may cause injury.
- Press should be placed on a sturdy, suitable stand at least 36"L x 24"W x 29"H.
- Work area must be kept clean, tidy and free of obstructions.
- Power supply cord must be disconnected before cleaning or servicing press.

## Connecting the System

### 1. CONNECT THE POWER CORD

1.1 Connect the power cord into a properly grounded electrical outlet with a sufficient amperage rating.

■ **VOLTAGE**

120 Volt - The Auto Open 6x6/LowRider Press requires a full 10 amp grounded circuit for 120 volt operation.

220 Volt - The Auto Open 6x6/LowRider Press requires a full 10 amp grounded circuit for 220 volt operation.

■ **EXTENSION CORDS** If used, should be as short as possible and not less than 12 gauge. Heavy duty cords are recommended.

■ **CIRCUITS** that have less than 10 amps or that have other high demand equipment or appliances (especially more than one heat seal machine) plugged in, should not be used.

**NOTE:** If the supply cord is damaged, it must be replaced by the manufacturer, its service agent or a similarly qualified person in order to avoid hazard. Use SJT type, rated 300 V for replacement.

**CAUTION** Failure to follow these instructions will cause:

1. Erratic controller functions.

2. Inaccurate displays and slow heat-up.

3. The circuit breaker to disengage.

## Turning the System On

### 2. SWITCH THE SYSTEM ON

- See the diagram below for switch placement.

**NOTE:** The Auto Open 6x6/LowRider Press is equipped with an Auto Sleep Mode. When the machine is not in use for a period of two hours, it will enter an energy saving sleep mode. To restore to normal operating mode, press any button on the display panel and allow the heat press to return to the target temperature

- 2.1 Locate the packaging bolt positioned on the top-center of the press. Packaging bolt must be removed prior to turning the press on or operating the press.



- 2.2 Now, locate the Power ON/OFF Switch on the side of the press, then turn the Power Switch on.



Power ON/OFF Switch

## Adjusting the Temperature

### 3. ADJUST THE TEMPERATURE

- Locate the LED Display on the Press.
- 3.1 Press the Mode Select button located in the center of the Control Panel. The (SET) and (TEMP) lights located next to the display will illuminate indicating you are in the adjust temperature mode.
- 3.2 Next, press the [-] button located to the left of the Mode Select button to lower the temperature setting, or press the [+] button located to the right of the Mode Select button to raise the temperature setting. The temperature can be set from 176° F (79° C) to 430° F (220° C).
- The LED will display changes as you make them.

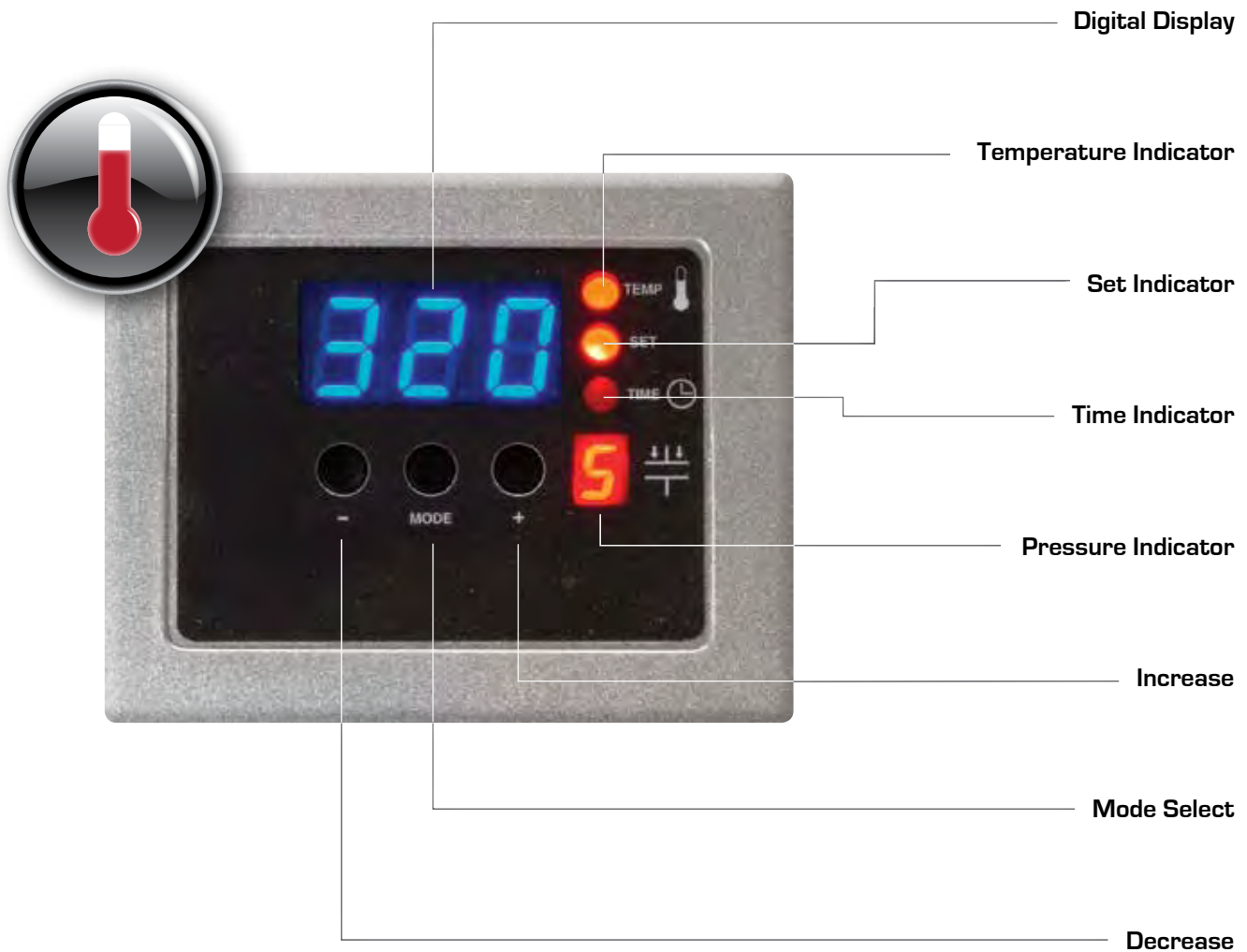



## Adjusting the Time

### 4. ADJUST THE TIME

- Your Auto Open 6x6/LowRider Press has two time settings. This will allow you to set different times when a two hit application is required. For single hit applications, you simply set both time settings the same.

4.1 Once you have adjusted the temperature, press the Mode Select button again. This will advance you to the Time #1 mode. The set and time lights will illuminate, indicating that you are in the Time #1 mode.

4.2 Adjust the time in the same manner that you adjusted the temperature. Once you have the Time #1 set, push the Mode Select button again to advance to the Time #2 setting. All three red LED lights will illuminate indicating that you are in the Set Time #2 Mode. Select the desired time and push the Mode Select button again to exit the time settings. All lights will be off and the press will return to the print mode.



**REMEMBER:** Press the Mode Select button ONCE to advance to the Adjust Temperature Mode



4.3 Press the Mode Select button A SECOND TIME to advance to the Time #1 mode.

4.4 Press the Mode Select button A THIRD TIME to advance to the Time #2 Settings.

4.5 Press the Mode Select button A FOURTH TIME to return to the Heat Up/Operating Mode.

## Adjusting the Pressure

### 5. ADJUST THE PRESSURE

5.1 First, locate the LED Display on the Press.  
(See figure 1)

- The Pressure Adjustment Knob is located in the center of the heat platen  
(See figure 2)

5.2 Adjust the pressure by turning the knob clockwise to increase pressure and counter clockwise to decrease pressure.

#### PRESSURE READOUT

A visual Pressure Readout is located on the lower right side of the LED Display. When the handle is locked into the Print Position, a pressure number will be displayed. Readout will be on a scale of 0 - 9. A 0 Pressure readout would indicate no pressure at all and 9 would indicate very heavy pressure. (See figure 1)



1 - 3 = Light Pressure  
4 - 7 = Medium Pressure  
8 - 9 = Heavy Pressure

5.3 To adjust the Pressure, simply turn the Pressure Adjustment Knob to the right or clockwise to increase the Pressure and to the left or counter clockwise to decrease the Pressure. The readout will display the Pressure when locked down in the print position.

**REMEMBER:** To allow for the thickness of your garment when adjusting the pressure.



Figure 1

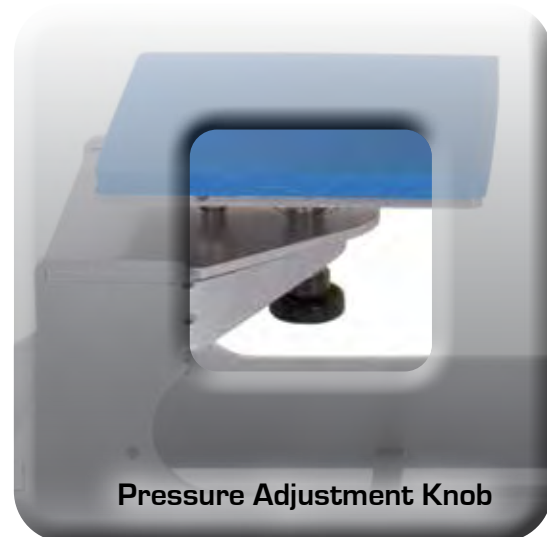

Pressure Adjustment Knob

Figure 2

**WARNING:** Structural damage caused by excessive pressure is not covered under the limited warranty!

## Pressing

### 6. PRESS

- Once your equipment has reached the designated temperature:

6.1 Position the garment and application and proceed to press.

6.2 Lower and lock the heat platen into the press position.  
This procedure will start the automatic timing process.

- The timer will automatically count down and lift the heat platen into the "UP" position when the press cycle is complete.

**NOTE:** Please be aware after time is complete, gas shocks will automatically release the platen into the "UP" position.

- The time will automatically re-set and you are ready to continue with the next application.



# AUTO OPEN SERIES

## Replacement Parts List

Item #	Part Name	Part #	Qty.
1	Hex Soc Button HD #10-32 x 1/2"	3-1011-164	4
2	Rubber Foot	1-1256	4
3	Acorn Hex Nut	3-1011-182	4
4	Adjustment Spindle	1-1023	1
5	Lower Platen 6 x 6	KIT 3-6911	1
6	Silicone Pad Gray 6 x 6 Blue	1-2138	1
7	Heat Platen 6 x 6	3-1334	1
8	Heat Platen Cover 6 x 6	2-1662	1
9	Finish Washer	1-1063	4
10	Cover Screw 10-24x1/2"	3-1011-217	4
11	Shoulder Bolt	3-1011-121	1
12	Hex Soc HD Cap Screw 1/2" - 13 x 3/4"	3-1011-236	1
13	All Thread Pin 1/4 - 20 x 4 3/4"	1-1042-1	1
14	PVC Spacer 1/2" I.D. x 5"	1-2096	1
15	Blue Foam Grip	1-2115	1
16	JCN Nut	2-1006-2	2
17	Electromagnet	1-1945-1	1
18	Silicone Pad 5/16" I.D. x 1 3/4" O.D.	1-2104	1
19	End Cap	1-1999	2
20	Hex Soc HD Shoulder Screw 5/16" x 1/2"	3-1011-233	1
21	6 x 6 Heater Arm	KIT 3-6912	1
22	PVC Spacer 1/2" I.D. x 3.30"	1-1049-1	1
23	Lift Link Kit	KIT 3-6909	1
24	Steel Pin 1/2" Dia. x 5 7/8"	2-1055-9	1
25	Nylon Washer	1-1048-3	8
26	Steel Spacer	1-2114	2
27	Hub Cap 1/2"	1-1107-1	8
28	Probe	1-1272-1	1
29	Conduit 12"	1-1048-2	1
30	Nylon Hex Nut	2-1006-20	2
31	Gas Spring	1-2246	1
32	Ball Stud 10mm	1-1939	2
33	Phillips Pan HD Screw #6 - 32 x 1/2"	3-1011-152	4
34	Steel Pin 1/2" Dia. x 6.45"	2-1055-11	2
35	PVC Spacer 1/2" I.D. x 3.80"	1-1049-5	1
36	PVC Spacer 1/2" I.D. x .7"	1-1049-4	2
37	Base 6 x 6	KIT 3-6907	1
38	Proximity Switch	1-1211	1
39	Circuit Breaker	1-1456	1
40	STX Housing	4-1172-S	1
41	On/Off Switch	1-2087	1
42	Display Overlay	1-2018-1	1
43	Terminal Block	1-1290	1
44	Triac	1-1059	1
45	Controller Bracket	2-1661	1
46	SSTT Controller Kit	KIT-3-6945	1
47	Handle Assembly 6 x 6	KIT 3-6910	1
48	Steel Pin 1/2" Dia. x 4.69"	2-1055-15	1

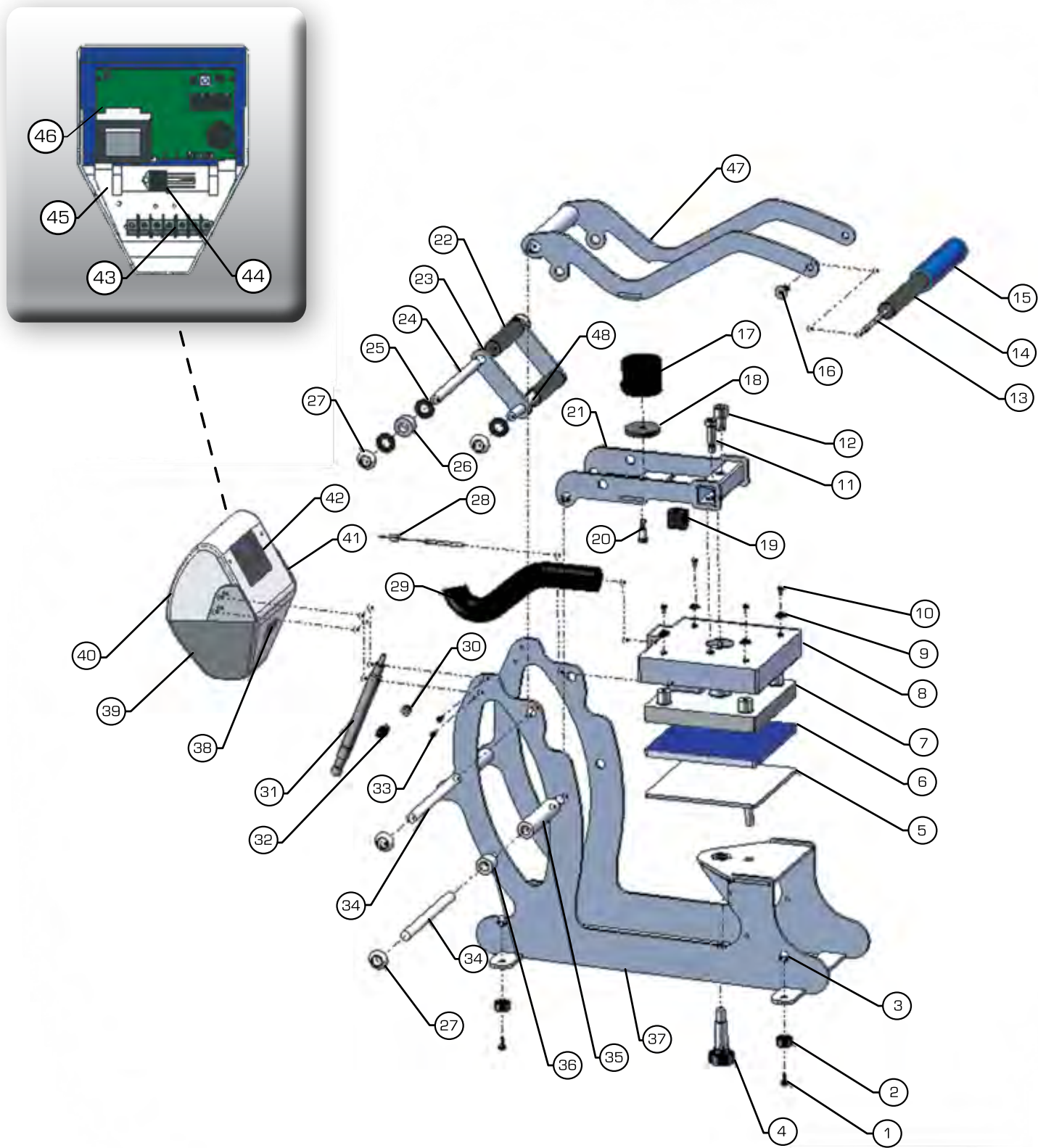

# AUTO OPEN SERIES

## Electrical Schematic

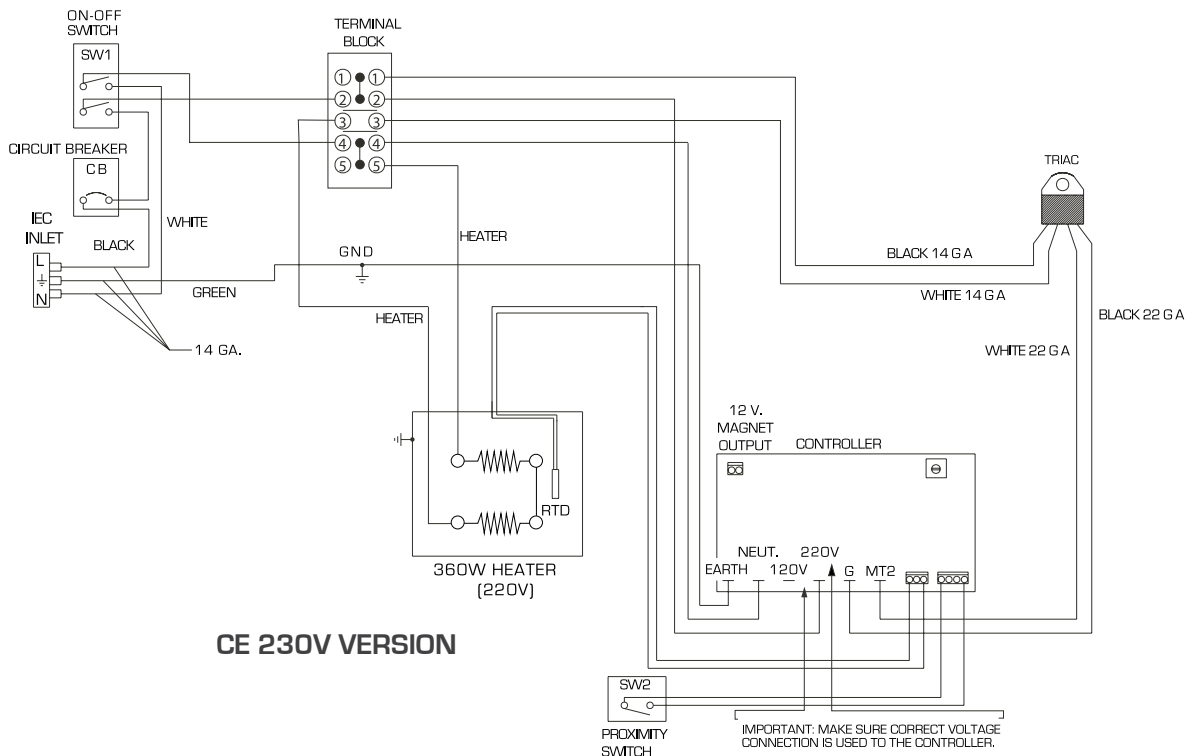
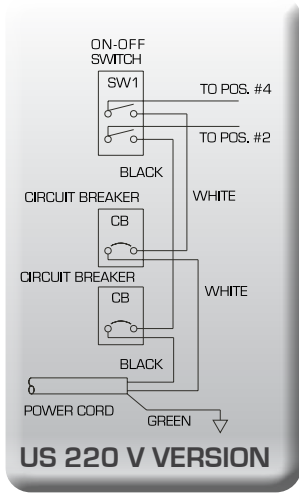
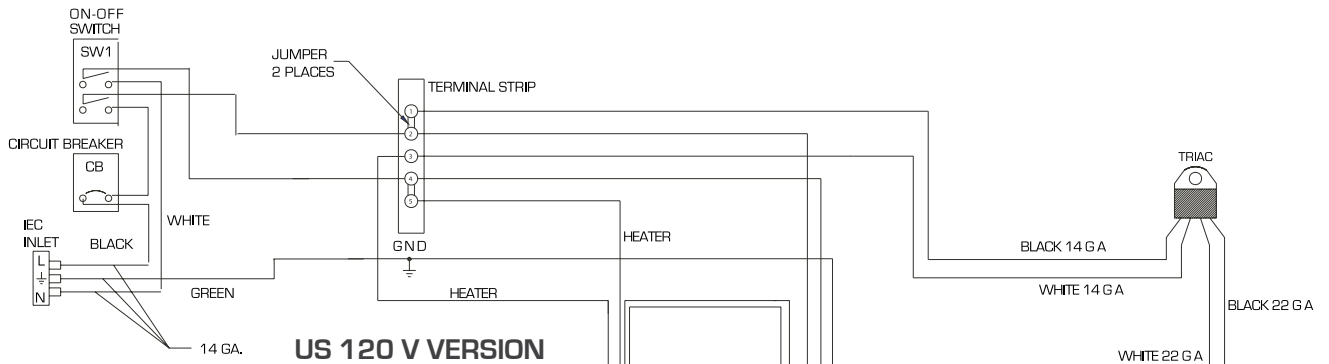

# Contact

Stahls' Hotronix®  
One Industrial Park  
Carmichaels, PA 15320  
U.S.A.

Technical Support  
800 . 727 . 8520  
Monday - Friday  
8am - 7pm EST

Customer Service  
800 . 727 . 8520  
Monday - Friday  
8am - 5pm EST

Replacement Parts  
800 . 727 . 8520  
8am - 7pm EST

Web  
[Hotronix.com](http://Hotronix.com)



This document includes multiple trademarks and describes equipment covered by many patents that are owned by GroupeSTAHL and/or its subsidiaries. GroupeSTAHL enforces its rights to protect these intellectual properties. © 2014

Hotronix®

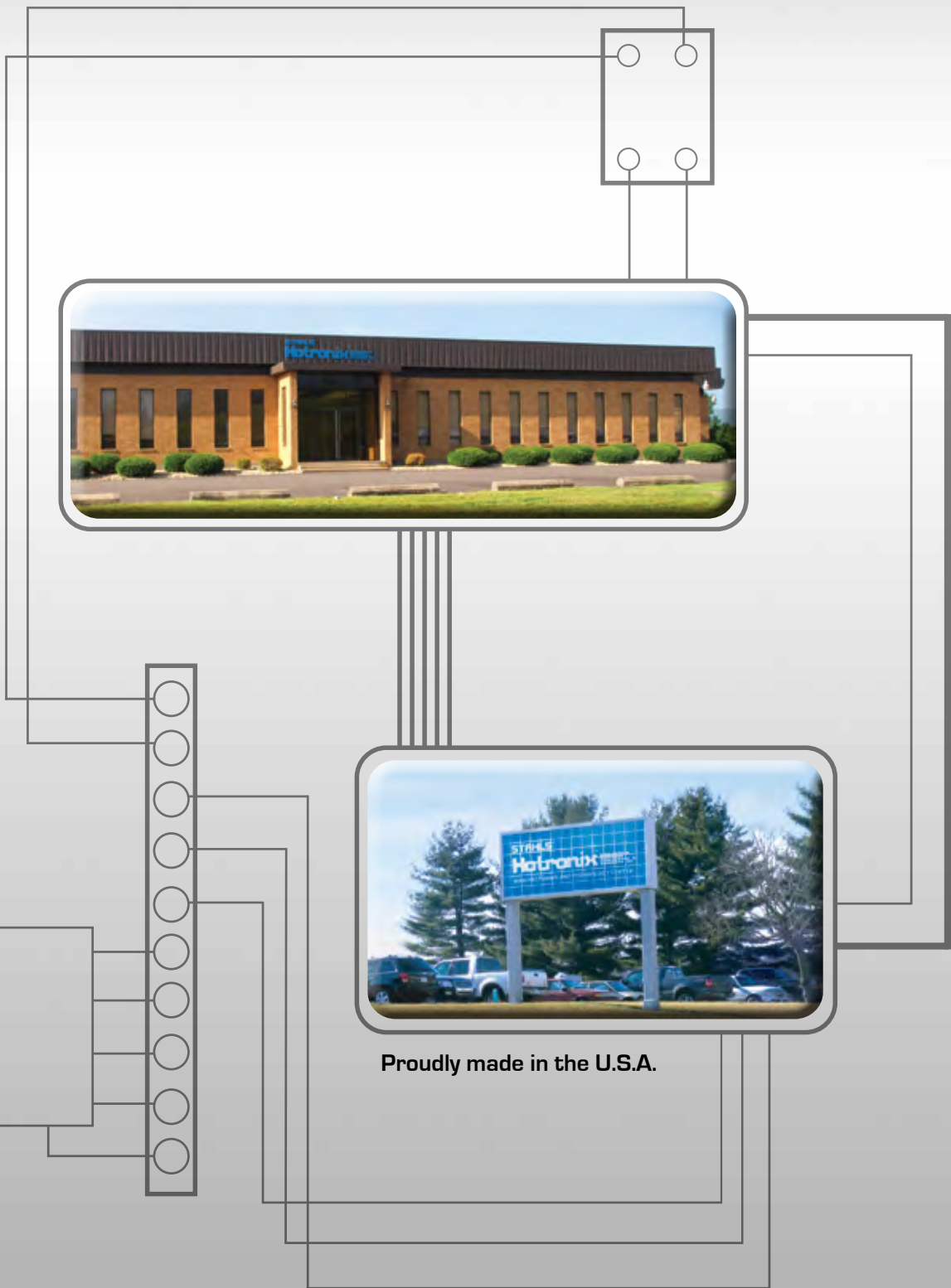

**Proudly made in the U.S.A.**

One Industrial Park . Carmichaels, PA 15320, U.S.A.  
Tech Support - Customer Service - Replacement Parts: 800 . 727 . 8520  
Web: Hotronix.com

**STAHL'S**  
**Hotronix**®  
a GroupeSTAHL company