

**JUKI®**

COMPUTER SEWING MACHINE

# **HZL-F series**

## **INSTRUCTION MANUAL**

---



**Attention**

Please read this instruction manual before using the machine as it contains important operational and safety information.

Keep this manual accessible so that you may refer to it at anytime while operating the machine.

# “IMPORTANT SAFETY INSTRUCTIONS”

“When using an electrical appliance, basic safety precautions should always be followed, including the following:”  
“Read all instructions before using this sewing machine.”

## “DANGER” To reduce the risk of electric shock:

1. “An appliance should never be left unattended when plugged in.”
2. “Always unplug this appliance from the electric outlet immediately after using and before cleaning.”
3. “Always unplug before re-lamping. Replace bulb with same type rated 3 Watts 12V.”

## “WARNING” To reduce the risk of burns, fire, electric shock, or injury to persons:

1. “Do not allow this appliance to be used as a toy. Close attention is necessary when this appliance is used by or near children.”
2. “Use this appliance only for its intended use as described in this manual. Use only attachments recommended by the manufacturer as contained in this manual.”
3. “Never operate this appliance if it has a damaged cord or plug, if it is not working properly, if it has been dropped or damaged, or dropped into water. Return the appliance to the nearest authorized dealer or service center for examination, repair, electrical or mechanical adjustment.”
4. “Never operate the appliance with any air openings blocked. Keep ventilation openings of the sewing machine and foot controller free from the accumulation of lint, dust and loose cloth.”
5. “Keep fingers away from all moving parts. Special care is required around the sewing machine needle.”
6. “Always use the proper throat plate. The wrong plate can cause the needle to break.”
7. “Do not use bent needles.”
8. “Do not pull or push fabric while stitching. It may deflect the needle causing it to break.”
9. “Switch the sewing machine off (“O”) when making any adjustments in the needle area, such as threading needle, changing needle, threading bobbin, or changing presser foot and the like.”
10. “Always unplug sewing machine from the electrical outlet when removing covers, lubricating, or when making any other user servicing adjustments mentioned in the instruction manual.”
11. “Never drop or insert any object into any opening.”
12. “Do not use outdoors.”
13. “Do not operate where aerosol (spray) products are being used or when oxygen is being administered.”
14. “To disconnect, turn all controls to the off (“O”) position, then remove plug from outlet.”
15. “Do not unplug by pulling on cord. To unplug, grasp the plug, not the cord.”

## “SAVE THESE INSTRUCTIONS”

“This sewing machine is intended for household use only.”  
Use only foot controller JC-001 with your HZL-F300, HZL-F400 or HZL-F600.

“The working temperature of sewing machine is from 5 to 40 degree Celsius. Do not use sewing machine under direct sunlight, near a heat source such as stove, iron, candle or any hot objects and in the place where temperature is high. Otherwise temperature inside sewing machine becomes high and/or vinyl of the power cord may be damaged, resulting in fire or an electric shock.”

“Always check a combination of material, thread and needle size. (Refer to page 24.) If the combination is not right, for example, sewing thick material such as denim with thin needle like size 11 and smaller, needle may break and it will cause injury to your body.”

Thank you for purchasing our products.

To safely and properly use this product, please read the instruction manual carefully and understand the properties of this computer sewing machine. This machine is composed of well-chosen brand-name parts and is well quality controlled. Please try a variety of different sewing methods and have fun.

### FOR USA AND CANADA ONLY

This appliance has a polarized plug (one blade wider than the other). To reduce the risk of electric shock, this plug is intended to fit in a polarized outlet only one way. If the plug does not fit fully in the outlet, reverse the plug. If it still does not fit, contact a qualified electrician to install the proper outlet. Do not modify the plug in any way.

- Do not expose machine to direct sunlight or humid atmosphere.

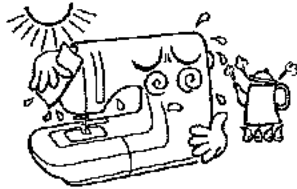

- Do not use thinner or other similar solvents to clean machine.

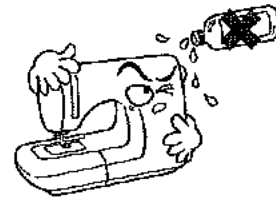

As the microcomputer(s), semi-conductor(s) and precise wiring board(s) is built in this sewing machine, please pay attention that the following condition(s) may occur.

- Use this product in a temperature between 5 and 40 degree Celsius.  
If temperature is extremely low, this sewing machine may not work properly.

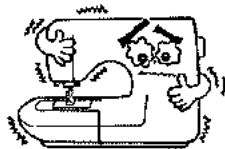

- This sewing machine will stop due to safety mechanism to prevent the machine from overheating, when it sews slowly and for a long time. In this event, Start and Stop button will not light.

The sewing machine will return to working condition after about 10 minutes.

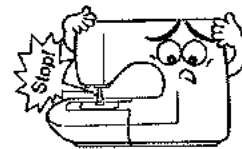

# Contents

|                                     |      |
|-------------------------------------|------|
| Important safety instructions ..... | 1, 2 |
| Principal parts .....               | 5    |
| Accessories .....                   | 6    |

## Basic operations

|   |        |
|---|--------|
| Function of operational buttons .....                                   | 7      |
| Connecting to the power supply .....                                    | 8      |
| Name and function of other operational buttons .....                    | 9, 10  |
| Speed control .....   | 11     |
| Presser foot lifting lever and installation of knee lifting lever ..... | 12     |
| Changing the presser foot .....   | 13, 14 |
| Bobbin thread preparation .....   | 15~18  |
| Needle thread preparation .....   | 19~22  |
| Threading the needle thread   |        |
| Automatic needle threader   |        |
| Pulling up the bobbin thread  |        |
| Attaching the needle .....  | 23     |
| Fabric, thread and needle table .....                                   | 24     |
| How to adjust thread tension .....                                      | 25     |
| How to adjust presser foot pressure .....                               | 26     |
| How to lower feed dog .....   | 26     |
| How to select a stitch pattern <b>F600</b> .....                        | 27, 28 |
| How to select a stitch pattern <b>F400</b> .....                        | 29, 30 |
| How to select a stitch pattern <b>F300</b> .....                        | 31, 32 |

## Practical sewing

|  |        |
|--|--------|
| Straight stitch .....                                | 33~37  |
| How to use seam guide line on the throat plate       |        |
| Automatic lock stitch and programmed thread trimming |        |
| How to change needle positions                       |        |
| How to change the stitch length                      |        |
| Other straight stitch patterns                       |        |
| Zigzag stitch .....                                  | 38     |
| Overcasting stitch .....                             | 39, 40 |
| Blind stitch .....                                   | 41~43  |
| Buttonhole stitches .....                            | 44~49  |
| Standard buttonholing                                |        |
| Keyhole buttonholing                                 |        |
| Buttonhole with gimp                                 |        |
| When changing the width of the buttonhole            |        |
| When changing the density of the seam                |        |
| Manual 2-step buttonhole .....                       | 50, 51 |
| Bartacking .....                                     | 52, 53 |
| Inserting zippers .....                              | 54~56  |
| Side zipper attachment                               |        |
| Butted zipper attachment                             |        |
| Shirring and gathering .....                         | 57     |
| Pintucking .....                                     | 58     |
| Welt seam .....                                      | 59     |
| How to use quilt guide <b>F600 / F400</b> .....      | 60     |
| Scallop stitches .....                               | 61     |
| Decorative stitches .....                            | 62     |

## Patchwork quilt

|   |        |
|---|--------|
| Patchwork piecing (joining) .....                   | 63     |
| Applique (1) .....                                  | 64     |
| Applique (2) .....                                  | 65     |
| Crazy quilt .....                                   | 66     |
| Stitch in ditch quilting <b>F600 Only</b> .....     | 67     |
| Quilting (straight stitch) <b>F600 / F400</b> ..... | 68     |
| Quilting (free motion) <b>F600 / F400</b> .....     | 69, 70 |

## Decorative stitches

|  |        |
|--|--------|
| One-point stitch/sewing letters .....        | 71~78  |
| Preparation before stitching .....           | 71     |
| Test sewing .....                            | 71     |
| Operational buttons and screen .....         | 72     |
| How to select patterns (letters) .....       | 73, 74 |
| How to edit patterns (letters) .....         | 75     |
| How to stitch a pattern (letters) .....      | 76     |
| Disposing thread ends of jump stitches ..... | 76     |
| Save / call of pattern (letters) .....       | 77, 78 |
| Character selecting methods .....            | 79     |

## Type and usage of Options .....

|  |        |
|--|--------|
| 1. Change of seam width of buttonhole .....                | 80     |
| 2. Change of needle position .....                         | 81     |
| 3. Setting the thread trimming foot switch<br>to OFF ..... | 82     |
| 4. Twin needle sewing .....                                | 83, 84 |
| 5. Guide .....   | 85     |
| 6. Contrast of liquid crystal display (LCD) .....          | 86     |
| 7. Button reception buzzer volume settings .....           | 87     |
| 8. Language setting .....                                  | 88     |
| 9. Elongation .....  | 89     |

|  |            |
|--|------------|
| Message catalog .....                          | 90         |
| Introduction of optional accessory parts ..... | 91, 92     |
| How to install wide table .....                | 93         |
| Machine maintenance .....                      | 94         |
| Performance check list .....                   | 95, 96     |
| List of stitch patterns <b>F600</b> .....      | 97, 98     |
| List of stitch patterns <b>F400</b> .....      | 99, 100    |
| List of stitch patterns <b>F300</b> .....      | 101, 102   |
| Specifications .....                           | back cover |

# Principal parts

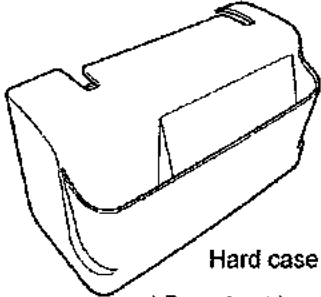
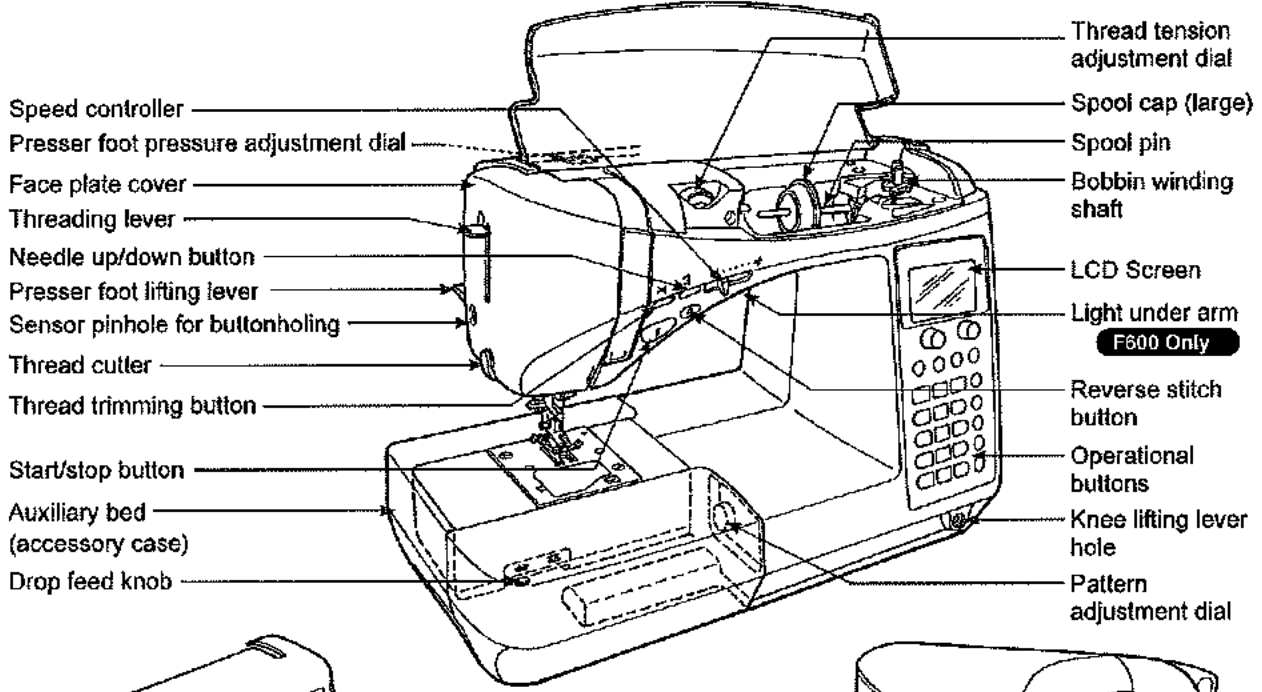

\* Do not put heavy objects onto hard case and wide table.

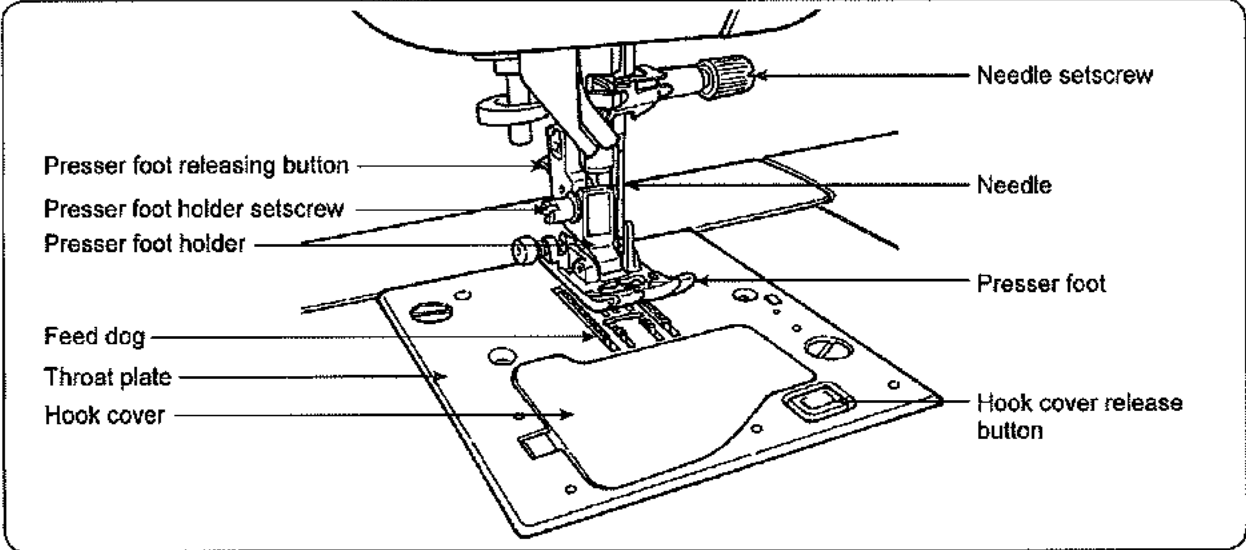
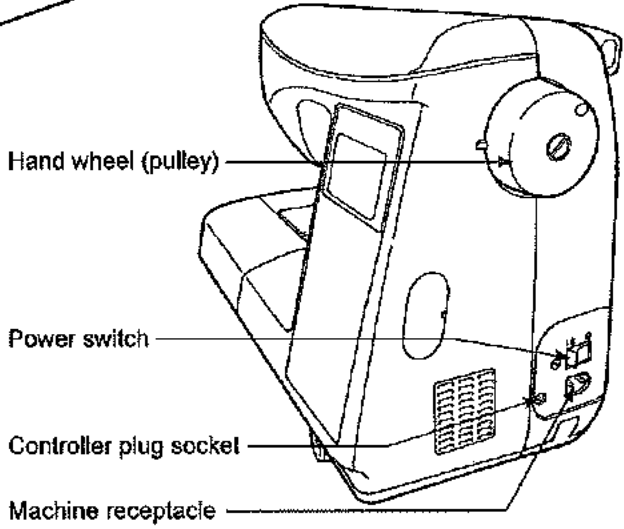
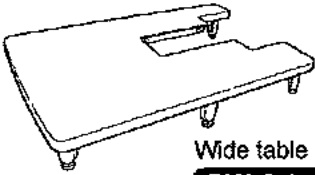

# Accessories

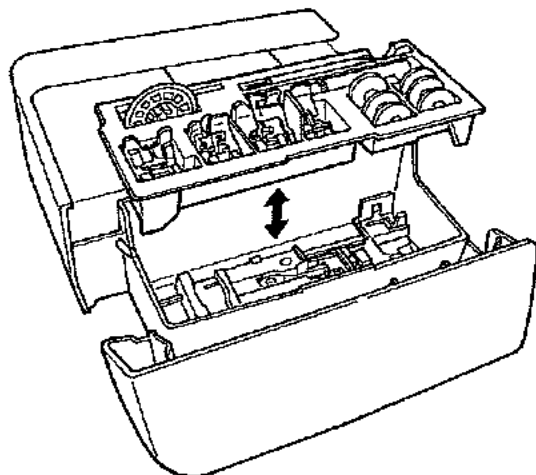

Draw the auxiliary bed out to the left.

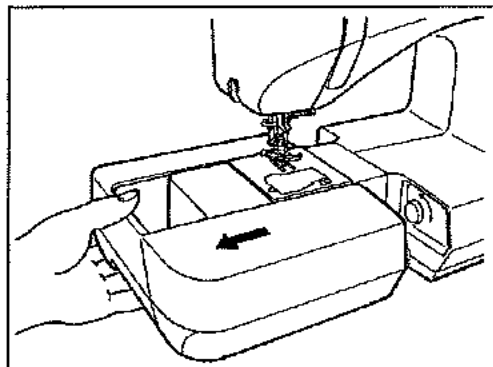

## • Inside the auxiliary bed.

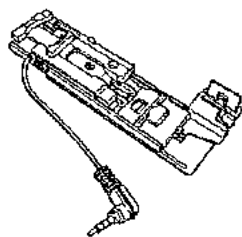

Buttonhole presser foot (E)



Manual buttonhole presser foot (I)



Overcasting presser foot (C)



Blind stitch presser foot (D)

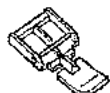

Zipper presser foot (B)



Bobbin (3)



T-shape screwdriver

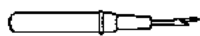

Ripper

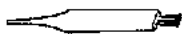
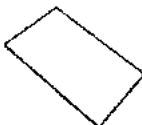

Cleaning brush

Needle set  
HAX 1 # 11 (1)  
# 14 (1)  
# 16 (1)  
for knit # 11 (1)



Spool cap (Small)



Spool cap (Middle)

## • Supplied with the machine



Standard presser foot (A)



Bobbin (1)



Spool cap (large)

## • Inside the accessories bag.

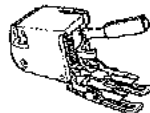

Walking foot (N)

F600 / F400



Patchwork presser foot (P)

F600 / F400

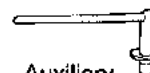

Auxiliary spool pin

F600 / F400



Open toe presser foot (O)

F600 Only



Quilt presser foot (Q)

F600 / F400

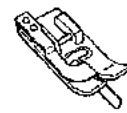

Smooth presser foot (T)

F600 Only



Quilt guide

F600 / F400

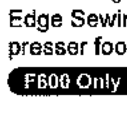

Edge Sewing presser foot (R)

F600 Only

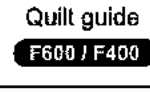

Eyelet punch

F600 Only



Twin needle

F600 / F400

## • Inside hard case



Foot Controller



Knee-lifting lever

F600 / F400



Instruction manual  
(This manual)



Power cord

## Function of operational buttons

### Needle up/down button

When machine stops, press this button to change the needle position. (When the needle is up, the needle moves down and vice versa.)

\* when a stitch pattern is not selected, needle does not move downward but you can move the needle up.

⚠ Even when the presser foot is raised, be aware that the needle moves up or downward.

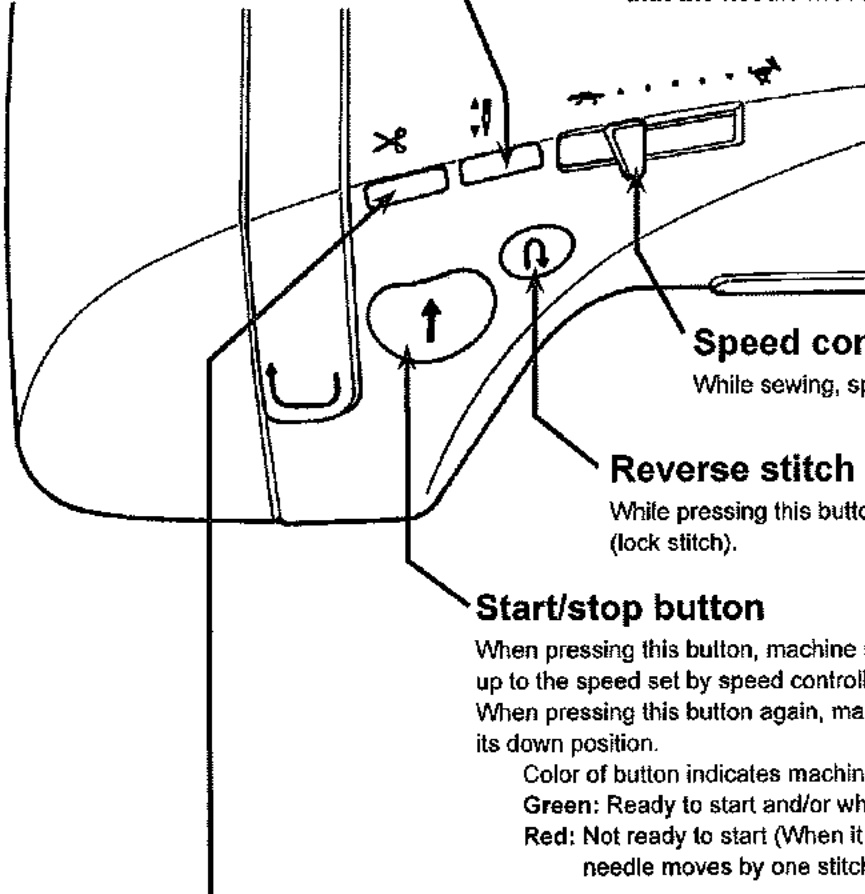

### Speed controller

While sewing, speed can be adjusted.

### Reverse stitch button

While pressing this button, machine sews reverse (lock stitch).

### Start/stop button

When pressing this button, machine starts to sew slowly and then up to the speed set by speed controller.

When pressing this button again, machine stops with needle at its down position.

Color of button indicates machine status.

Green: Ready to start and/or while sewing

Red: Not ready to start (When it is pushed in red condition, needle moves by one stitch.)

### Thread trimming button

After sewing, press this button to trim both threads automatically.

### Notes for thread trimming:

1. Do not use thread thicker than No.30.
2. After trimming, the stitch can be done without pulling up bobbin thread.
3. When sewing again after thread trimming, if you pull up the bobbin thread again and place it underneath the presser foot together with needle thread, you can avoid birds nest on the wrong side of the fabric.
4. Regularly clean the machine (refer to page 94), as dust in the area of the thread trimming unit may cause malfunction.



## Connecting to the power supply

### ■ Connecting to the power supply

### ⚠ Warning

- When machine is not in use, turn off the power (turn to "O") and pull out the power plug. Otherwise, it may cause electric shock and/or fire.

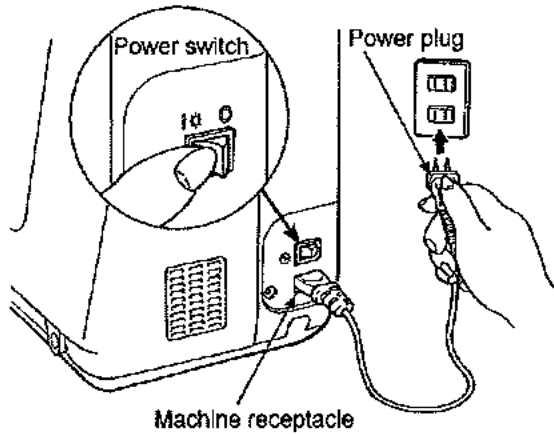

#### ★ In case Start/stop button is used:

1. Turn off power switch (turn to "O"), push power cord plug into machine receptacle.
2. Plug power plug into electric outlet.
3. Turn on power switch. (Turn to "I".)

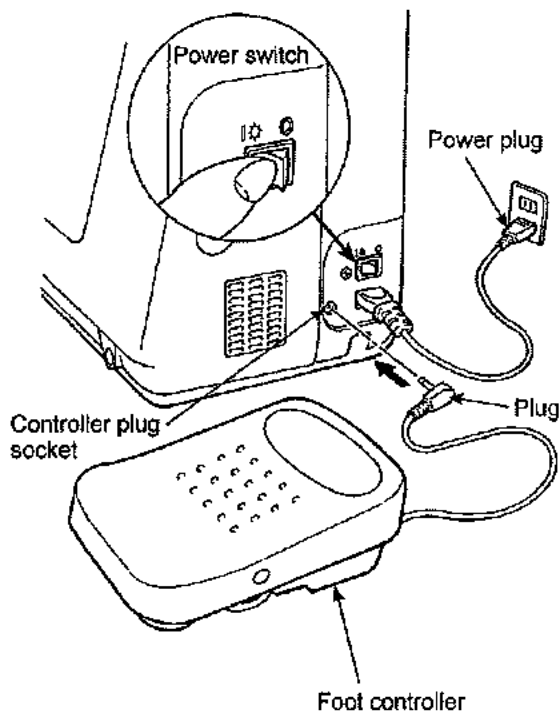

#### ★ In case Foot controller is used:

1. Turn off power switch (turn to "O"), push power cord plug into machine receptacle.
2. Plug power plug into electric outlet.
3. Turn on power switch. (Turn to "I".)

- \* When the foot controller is used, start/stop button will:
- Sewing start: will not operate
  - Sewing end: will operate





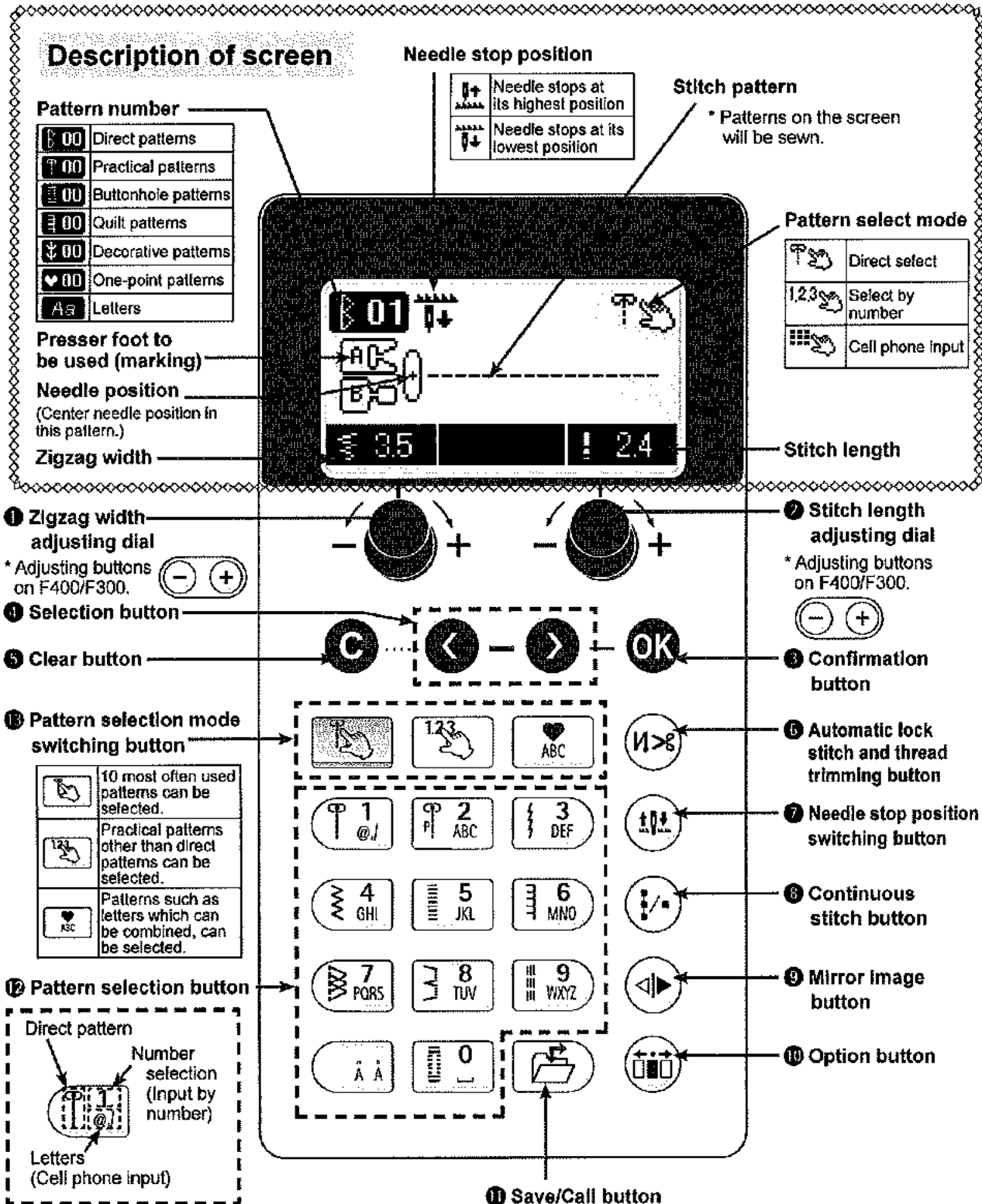

















# Name and function of other operational buttons

## Operational buttons and screen



## Name of operational button

## ■ Name and function of operational buttons

|   |   |  |
|---|---|--|
|    | <b>Zigzag width adjustment dial</b><br>* buttons on F400/F300.  | This is used to change the zigzag width and the needle position.<br>  |
|    | <b>Stitch length adjustment dial</b><br>* buttons on F400/F300. | This is used to change the stitch length.<br>   |
|    | <b>Confirmation button</b>                                      | This is used to confirm the selected stitch pattern and/or settings.   |
|    | <b>Selection button</b>   | This is used to move the cursor.   |
|    | <b>Clear button</b>   | This is used to delete the selected stitch pattern and to cancel each setting. When pressing the button continuously, all the saved stitch patterns will be deleted.   |
|    | <b>Automatic lock stitch and thread trimming button</b>         | When it is pressed, symbol "  " will be shown on the screen. The machine will automatically lock stitches at sewing-start and sewing-end and then trim both threads.  |
|   | <b>Needle stop position switching button</b>                    | When it is pressed, either symbol "  " or "  " will be shown on the screen. When sewing with symbol "  ", the needle stops at its highest position. When sewing with the symbol "  ", the needle stops at its lowest position. |
|  | <b>Continuous stitch button</b>                                 | This button is valid only when "  " mode. When it is pressed, symbol "  " will be shown on the screen. The machine will sew the selected stitch patterns continuously. When it is pressed again, the machine will cancel this function. * When it is pressed while sewing, the machine will stop after the selected patterns are sewn completely.  |
|  | <b>Mirror image button</b>                                      | After selecting a stitch pattern, press this button to make a mirror image of the selected pattern. * There are some patterns that can not make a mirror image.  |
|  | <b>Option button</b>  | It is possible to change the following function and settings. <ul style="list-style-type: none"> <li>• Seam width of buttonhole</li> <li>• Thread trimming by foot controller</li> <li>• Guide</li> <li>• Buzzer volume</li> <li>• Elongation</li> <li>• Needle position</li> <li>• Twin needle</li> <li>• LCD display contrast</li> <li>• Language</li> </ul> * Optional functions vary from stitch pattern to stitch pattern. (Refer page 80~89 for more details.)   |
|  | <b>Save/call button</b>   | This is used to save and/or call a pattern. The machine can save maximum 10 patterns. (Refer to page 77 and 78 for more details.)  |
|  | <b>Pattern selection button</b>                                 | A stitch pattern can be selected. * Usage of the buttons varies by pattern selecting mode. (Refer to page 27~32 for more details.)   |
|  | <b>Pattern selection mode switching button</b>                  | When the pattern selection mode needs to be changed, press the desired button. The selected button will be illuminated.  |

# Speed control

## ■ Speed control

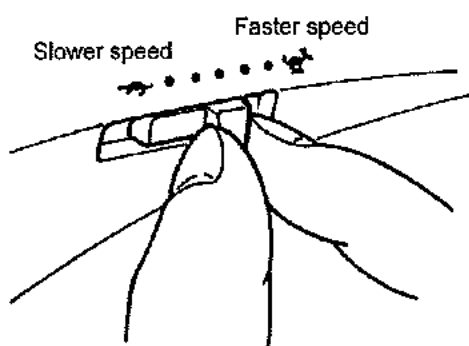

### ★ Speed controller

Maximum sewing speed can be freely set by the speed controller.

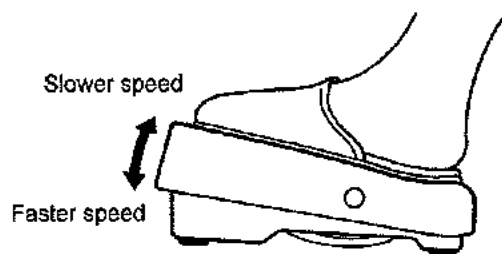

### ★ Foot controller

To run the machine, press the foot controller. The harder you press, the faster the machine sews. Speed controller will set the maximum sewing speed.

**Pressing harder → faster speed**  
**Pressing weaker → slower speed**

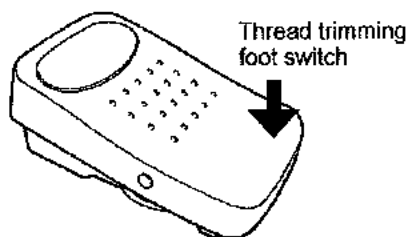

### “Thread trimming foot switch”

When the heel side of the foot controller is pressed, the threads are trimmed.

→ It is also possible to cancel this function.  
(Refer to page 82.)

\* Always clean the foot controller.

It is important that you do not place any objects on the foot controller as it may cause injury to the user and may cause malfunctions.

## Presser foot lifting lever and installation of knee lifting lever

### ■ Presser foot lifting lever

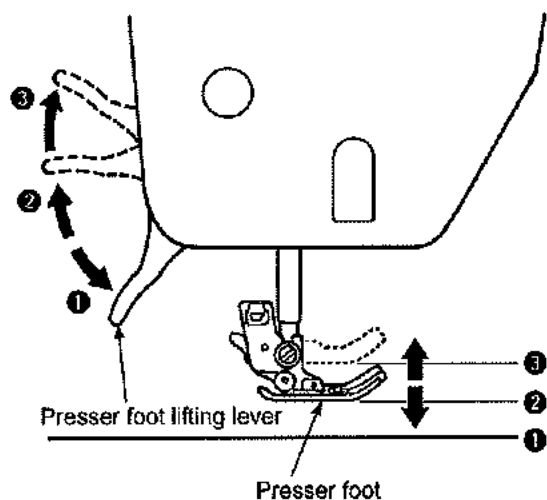

The presser foot can be up or down position by using the presser foot lifting lever.

- ❶ Lowered position ..... Presser foot should be lowered when sewing.
- ❷ Ordinary lift position ..... This position is used for fabric removal and/or changing the presser foot.
- ❸ Extra lift position ..... This position is used to put heavy materials underneath the presser foot.

\* Be careful that the presser foot and the needle should not interfere when the needle is in down position and the presser foot is raised to the extra lift position.

### ■ Installation of knee lifting lever **F600 / F400**

The knee lifting lever is useful when a quilt is being sewn and for other projects that require the use of both hands. With the knee lifting lever, you are able to control the position of the presser foot without using your hands.

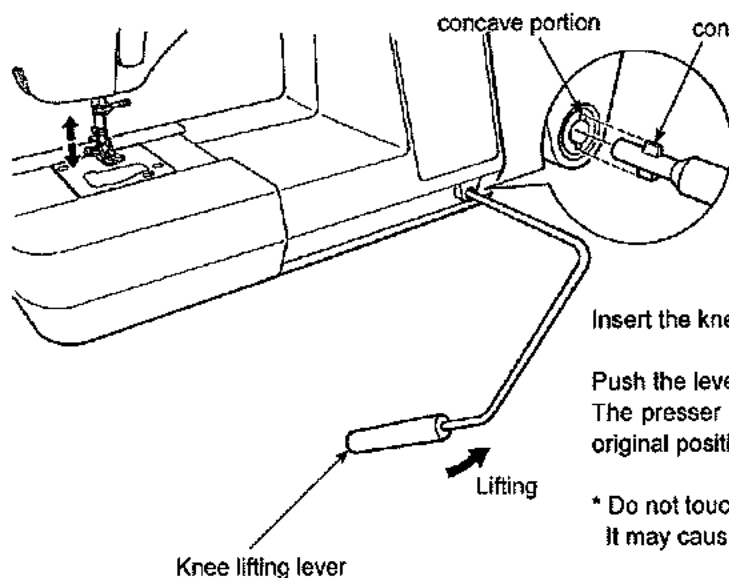

Insert the knee lifting lever so that concave and convex meet.

Push the lever to right-hand side to lift the presser foot. The presser foot is lowered when the lever goes back to the original position.

\* Do not touch the knee lifting lever while sewing. It may cause a deformation of a stitch pattern.

## Changing the presser foot

### ■ Removing and installing the presser foot

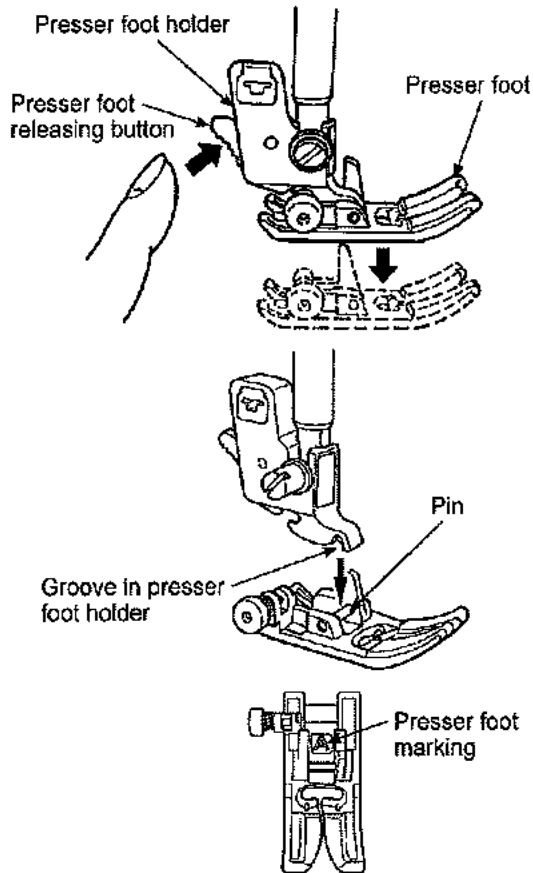

**▲ Attention**

Turn off the power before replacing presser foot.

### ★ Removing presser foot

1. Raise the needle and presser foot.
2. Press the presser foot releasing button to remove the presser foot.

### ★ Installing presser foot

Align the pin of the presser foot and the groove in the presser foot holder. Then lower the presser foot holder with the presser foot lifting lever.

\* Each presser foot has a marking. Use the appropriate presser foot for the stitch pattern to be sewn.

### ■ Removing and installing presser foot holder

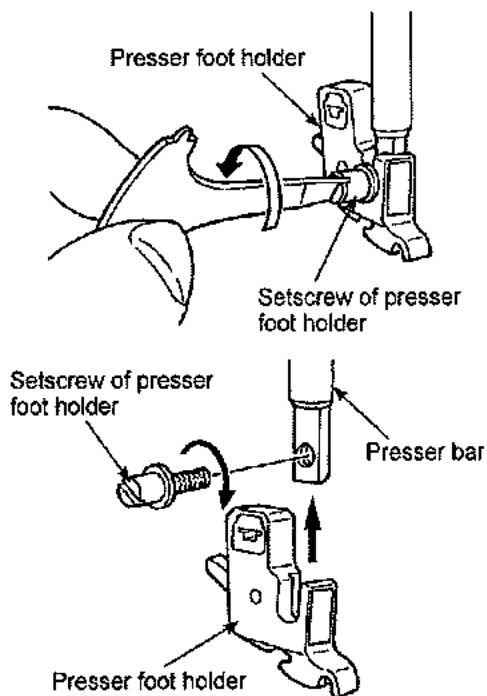

### ★ Removing presser foot holder











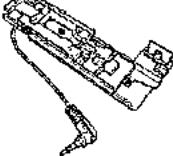

1. Lift the needle and presser foot lifting lever.
2. Loosen the setscrew of the presser foot holder to the left and remove the presser foot holder.

### ★ Installing presser foot holder

Align the screw hole at the presser bar with the hole of presser foot holder (long groove). Tighten the setscrew firmly by turning it to the right side.

## ■ The type and application of the presser foot

Marking of presser foot

|   |  | Marking of presser foot<br>↓ |   |
|---|--|------------------------------|---|
|    | <b>Standard presser foot</b>                 | <b>A</b>                     | This is used mainly for straight stitch and zigzag stitches. Use this presser foot especially when sewing heavy-weight materials.   |
|    | <b>Zipper presser foot</b>                   | <b>B</b>                     | This is used to attach zippers.   |
|    | <b>Overcasting presser foot</b>              | <b>C</b>                     | This presser foot is used exclusively for overcasting to prevent the cut edge of fabrics from fraying.  |
|    | <b>Blind stitch presser foot</b>             | <b>D</b>                     | This presser foot is used for blind stitch on hems of trousers and skirts, or sleeves.  |
|    | <b>Buttonhole presser foot</b>               | <b>E</b>                     | This presser foot is used for automatic buttonholing.   |
|   | <b>Manual buttonhole presser foot</b>        | <b>I</b>                     | This is used for sewing decorative stitches, letters and bartacks. Also for manual buttonhole (pattern No. 03).   |
|  | <b>Walking foot</b><br>F600 / F400           | <b>N</b>                     | In general, this presser foot is used for difficult-to-feed materials such as knits, jerseys, vinyl, artificial leather and leather or quilting.                                      |
|  | <b>Patchwork presser foot</b><br>F600 / F400 | <b>P</b>                     | This presser foot is used for patchwork stitches. There are two seam lines, 1/4-inch and 1/8-inch from center needle position.  |
|  | <b>Smooth presser foot</b><br>F600 Only      | <b>T</b>                     | This presser foot is used for non-slippery materials like vinyl and satin stitches.   |
|  | <b>Open toe presser foot</b><br>F600 Only    | <b>O</b>                     | This is used for the applique and decorative stitches. (Front part of the presser foot is open for better visibility.)  |
|  | <b>Quilt presser foot</b><br>F600 / F400     | <b>Q</b>                     | This is used for the quilt stitch. (Machine setting: Straight Stitch and Center needle position)  |
|  | <b>Edge Sewing presser foot</b><br>F600 Only | <b>R</b>                     | This is used for patchwork, sewing center line of joined materials by using the center guide of the presser foot.<br>* Fine tune the needle position by zigzag width adjustment dial. |



## Bobbin thread preparation

### ■ Taking out the bobbin

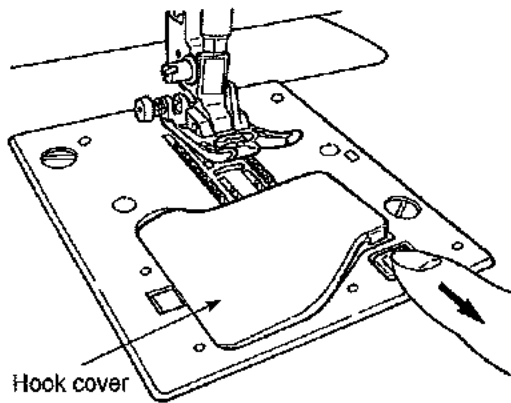

#### Attention

When the bobbin is taken out and/or put into the bobbin case, turn off the power (turn to "O").

**1** Open the hook cover.

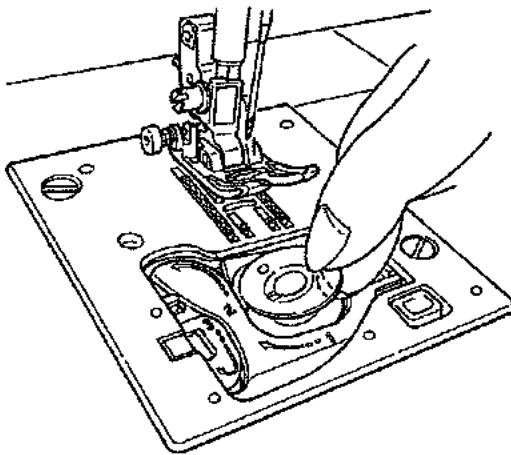

**2** Take out the bobbin.

\* If the bobbin has too little thread, do not use it as the thread will get tangled.

\* Use only the designated bobbin. Other bobbins may cause malfunction.

### ■ Setting thread spool

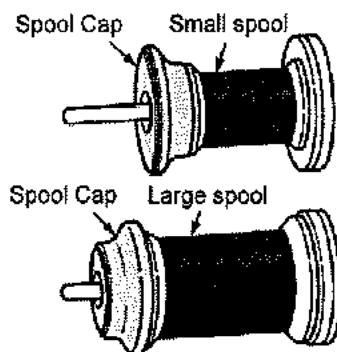

**1** Place a thread spool to spool pin and a spool cap onto the spool pin.

\* Do not use the thread cone with a small amount of thread. This may cause thread tangling and/or the thread coming out of the eye of the needle when starting to sew.

There are three types of the spool caps, large, medium and small. Choose the size of spool cap according to the thread spool to be used.



## ■ Winding the bobbin thread

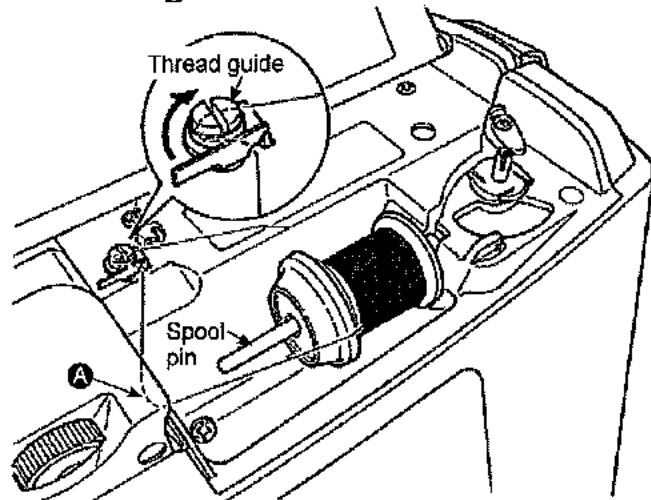

\* An exclusive motor is built-in for winding bobbin so that you can wind bobbin at any time.

**1** Place the thread spool to the spool pin.

**2** Thread the guide **A** and then thread the thread guide (guide in the circle) for bobbin winding

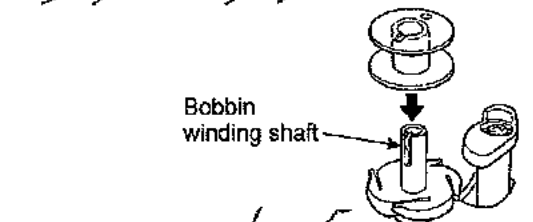

**3** Set the bobbin on the bobbin winding shaft.

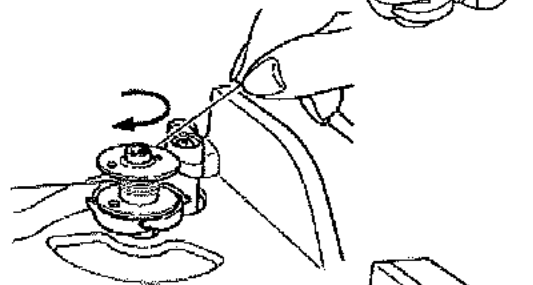

**4** Wind the thread to the bobbin 4-5 times in clockwise direction.



**5** Put the thread end into the guide at the bobbin winding shaft and pull it to the right side to cut it.

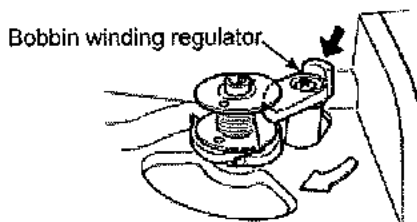

**6** Push the bobbin winding regulator towards the bobbin to start winding the bobbin.

\* Be careful that the bobbin winding regulator works as a switch.

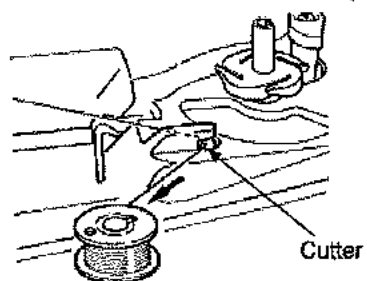

**7** When winding is finished, the shaft stops automatically, the bobbin winding regulator moves to right and return to the original position.

Remove the bobbin from the bobbin winding shaft and cut the thread by cutter.

\* Bobbin winding will automatically stop even while winding, when the winding speed is reduced due to a load to the bobbin winding motor caused by thread tangling.

## ■ Setting the bobbin

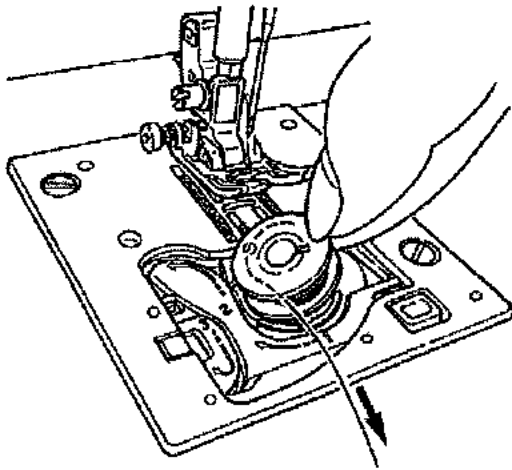

**1** Put the bobbin in the bobbin case.

\* Place the bobbin so that thread winds counterclockwise.

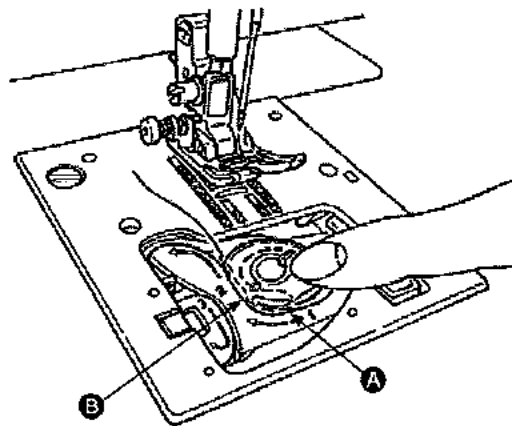

**2** Thread groove **A** and **B** by pulling the thread end.

\* It will be easier to thread grooves when you press the bobbin lightly with your finger.

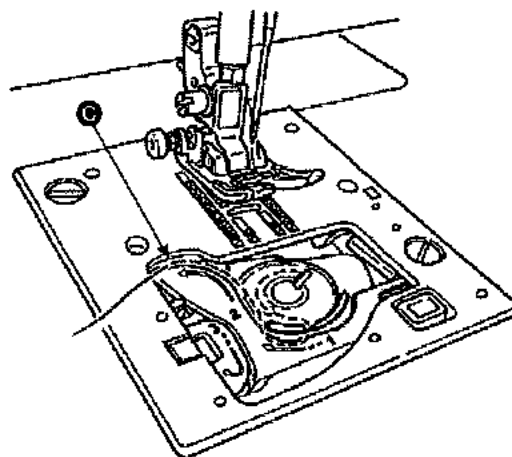

**3** Thread guide **C** by pulling the thread to left side.

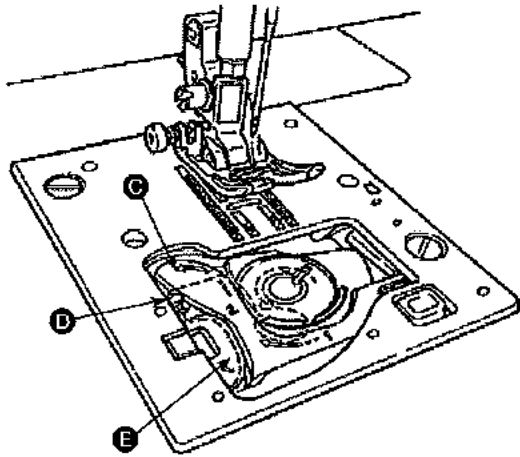

**4** Thread to guide **D** and **E** leave the thread underneath. (Thread guide **E** first and it will thread to guide **D** as well.)

\* When pulling bobbin thread, bobbin rotates counterclockwise. If bobbin rotates clockwise, put the bobbin upside down.

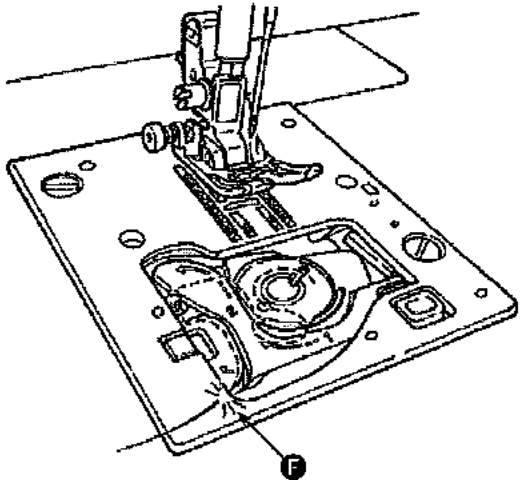

**5** Cut the thread with the built-in cutter **F**.

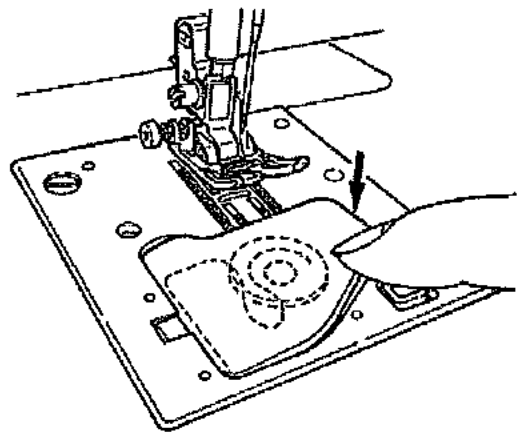

**6** Close the hook cover.

You can start to sew in this condition (without pulling up the bobbin thread), however, if you want to sew with the bobbin thread pulled out, refer to "Pulling up the bobbin thread" in the page 22.

# Needle thread preparation

## ■ Threading the needle thread

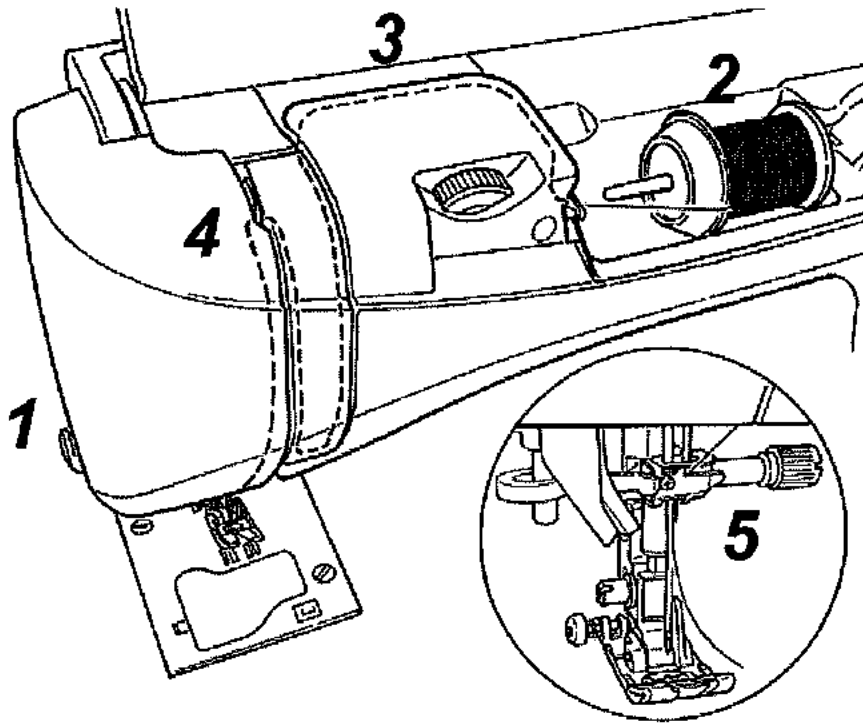

### Note:

Make sure to push the needle to the top.

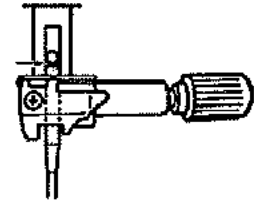

It is impossible to perform stitching if the needle is not correctly installed or a bent needle is used. Pay close attention as this will cause machine malfunction.

- \* Use the needle: No.11-16 and the thread: No.30-90.
- \* When twin needle is used, the automatic needle threader can not be used.

\* Align the marking at the hand wheel with the one on the machine body.

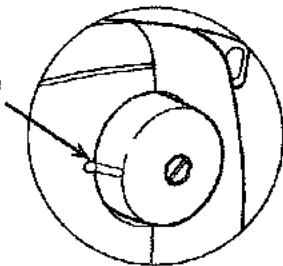
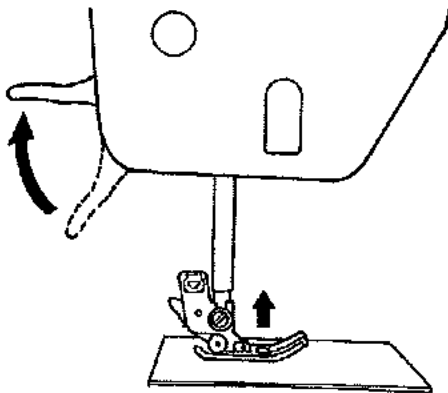

**1** Lift the presser foot lifting lever.

**2** Place a thread spool to the spool pin and a spool cap onto the spool pin.

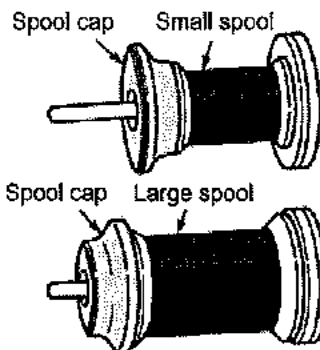

There are three types of the spool caps, large, medium and small. Choose the size of spool cap according to thread spool to be used.

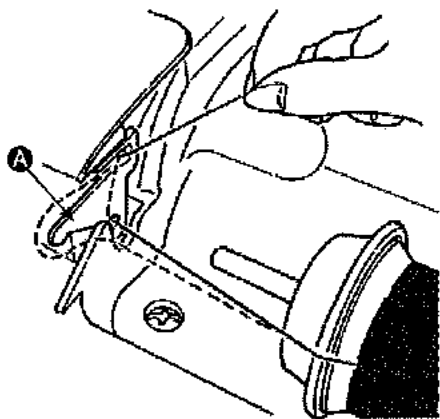

**3** Thread to guide **A**.

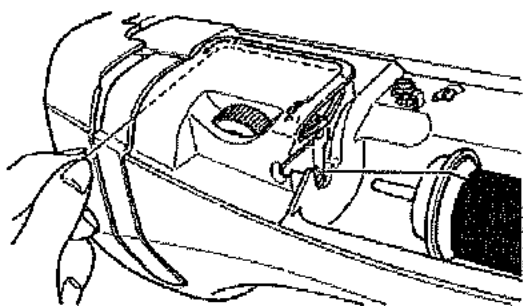

**4** Hold the thread end and thread according to the arrow marking.

\* Make sure that the presser foot is raised. Otherwise the machine is not correctly threaded.

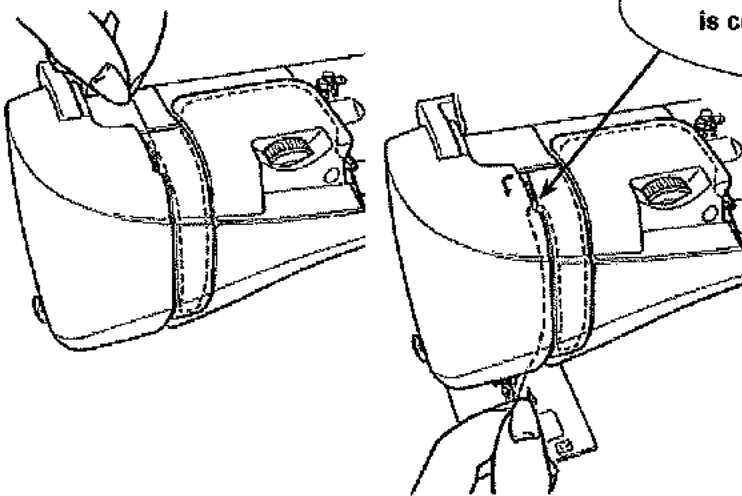

\* Check that the thread take-up is correctly threaded.

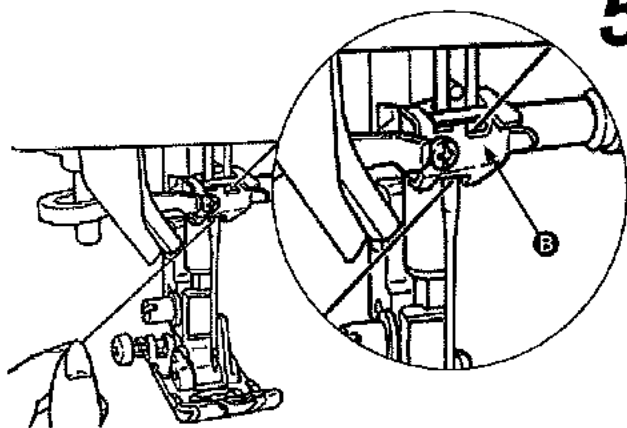

**5** Thread the guide **B** from the right-hand side.

\* It is easier to thread by pulling thread towards left back side.

## ■ Automatic needle threader

Thread cutter \* Be careful that the cutter is inside.

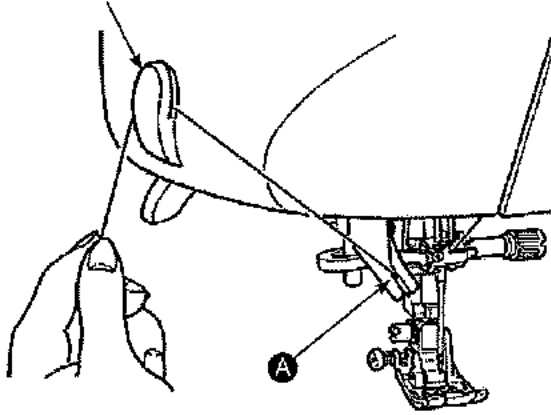

**1** Lower the presser foot.

\* The automatic needle threader sometimes fails to thread the needle when the presser foot is raised.

**2** Thread to **A** and cut the thread with the thread cutter.

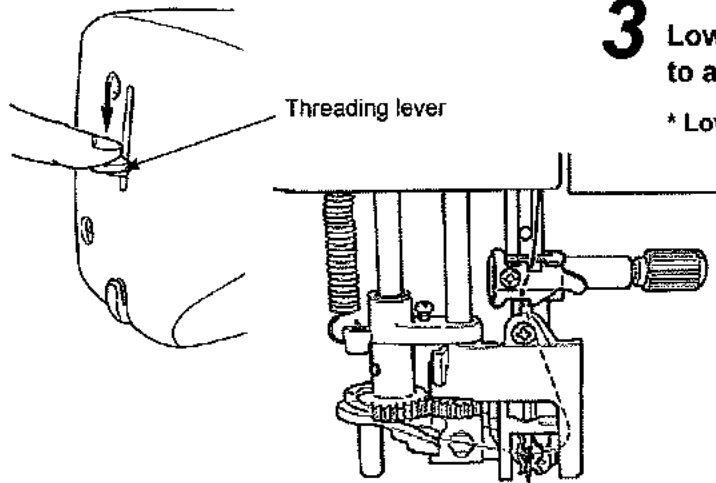

**3** Lower the threading lever until it comes to a complete stop.

\* Lower the threading lever slowly.

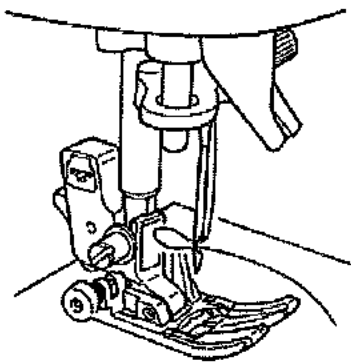

**4** Release the threading lever and the needle thread is threaded to the needle eye.

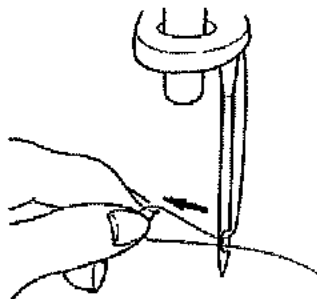

**5** Pull the thread backward.

Pull out the thread from the needle eye by approx. 10 cm or 4 inches long.

## ■ Pulling up the bobbin thread

### Basic operation:

You can start to sew without pulling up the bobbin thread, however, if you want to sew with the bobbin thread pulled out, follow the directions below.

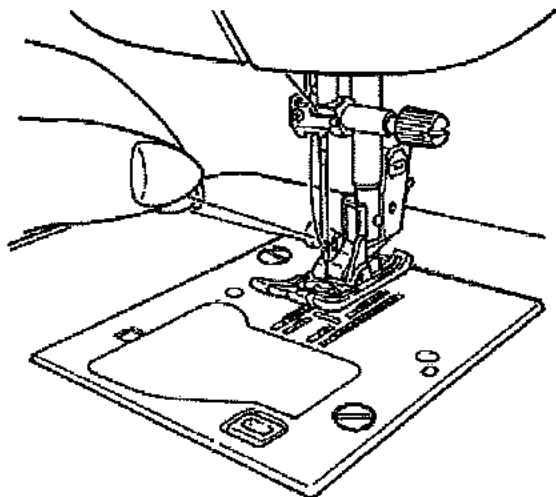

- 1** Lift the presser foot and lightly hold the end of the needle thread.

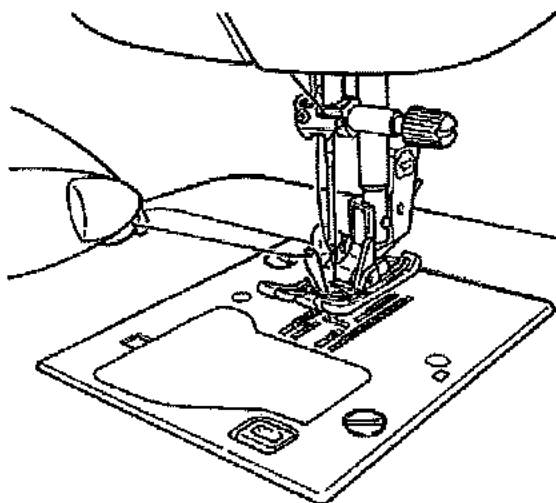

- 2** Turn the hand wheel towards you to move the needle up and down. Loop of bobbin thread will be pulled out when you will pull the needle thread lightly.

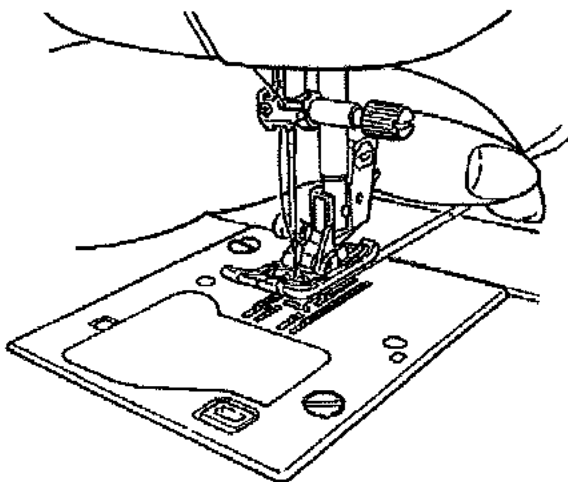

- 3** Pull out both needle and bobbin threads by approx. 10 cm (4 inches) long and pass them under the presser foot towards the back of the machine.

## Attaching the needle

### **Warning**

When changing the needle, turn off the power.

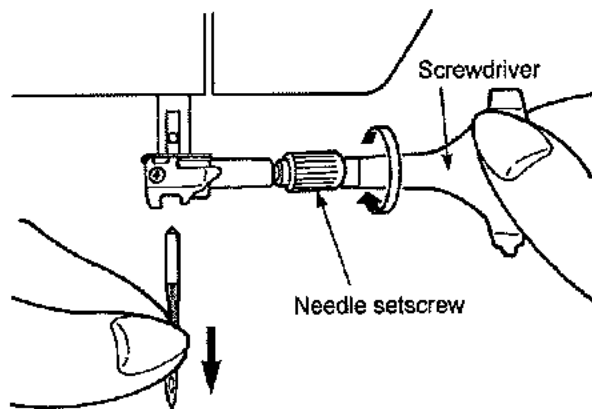

### **1 Removing needle**

1. Turn the hand wheel towards you until the needle comes to the highest position and lower the presser foot.
2. Turn the needle setscrew towards you 1-2 times and remove the needle.

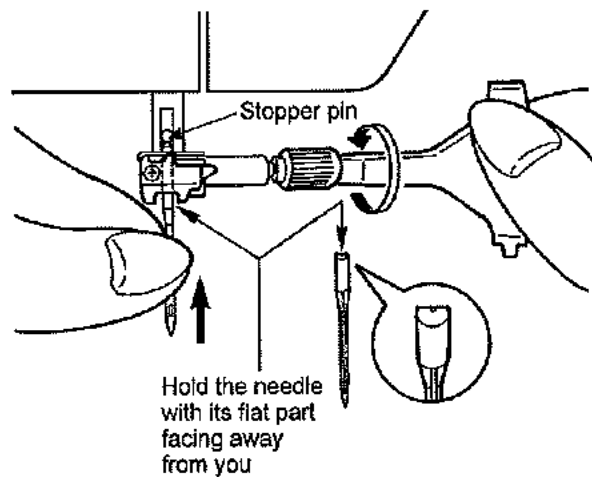

### **2 Attaching the needle**

(The needle cannot be inserted unless it is correctly positioned.)

Hold the needle with its flat part facing away from you, and insert it fully until it touches the stopper pin. Securely tighten the needle setscrew.

### ■ Needles to be purchased

When purchasing spare needles, specify HAX 1 (130/705H) or HAX 1 SP (needle for knits).

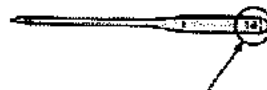

#### **Needle size:**

The larger the number, the thicker the needle.

### ■ Checking the needle

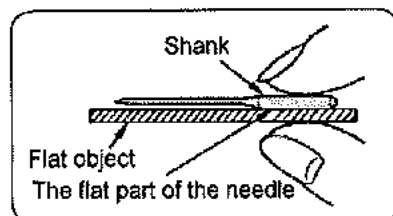







Check the needle for its straightness occasionally. Any bent needle would cause skipped stitches, thread breakage or damage to materials.

**Attention:** The machine will not sew if the needle is not inserted correctly and/or a bent needle is used. It will cause damage to the machine.

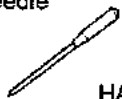

## Fabric, thread and needle table

|  | Fabric<br> | Thread<br> | Needle<br><br>HA×1 |
|--|---|---|---|
| <b>Light-weight materials</b><br><br>   | Lawn  | Silk thread ..... No.80,90<br>Spun thread ..... No.80,90                                    | No.11   |
|  | Georgette   |   |   |
|  | Tricot  | Spun thread ..... No.60-90  | Knit needle<br>No.11  |
|  | Wool and synthetic fabrics  | Silk thread ..... No.80<br>Spun thread ..... No.80-90                                       | No.11-14  |
| <b>Medium-weight materials</b><br><br>  | Cotton and synthetic fabrics  | Spun thread ..... No.50, 60   | No.11-14  |
|  | Light jersey  | Silk thread ..... No.50<br>Spun thread ..... No.50, 60                                      | Knit needle<br>No.11  |
|  | Ordinary wool and synthetic fabrics   | Silk thread ..... No.50<br>Spun thread ..... No.50, 60                                      | No.11-14  |
| <b>Heavy-weight materials</b><br><br> | Denim   | Spun thread ..... No.30-50  | No.14-16  |
|  | Jersey  | Silk thread ..... No.50<br>Spun thread ..... No.50, 60                                      | Knit needle<br>No.11-14   |
|  | Coat  | Silk thread ..... No.50   | No.11-14  |

- \* In general, the same thread is used for both needle and bobbin threads.
- \* Thin thread and needle will be used for light-weight fabrics and thick thread and needle will be used for heavy-weight materials.
- \* Check that the combination of needle and thread is OK by trial sewing on the material which will be sewn.
- \* Knit needle is good for stretchy fabrics (such as knits) and synthetic fabrics.
- \* Use thread No. 30 - 90.
- \* When it is difficult to go over an overlapped section, guide the fabric by hand.
- \* When sewing decorative stitches or letters (Page 28, 30 and 32), use knit needle for better finish.

# How to adjust thread tension

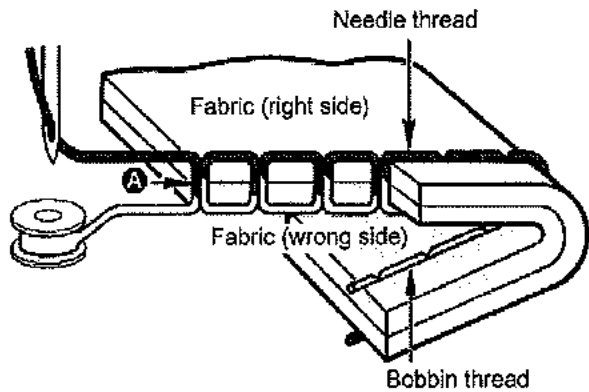

## Well-balanced thread tension

**Straight stitch:** Needle and bobbin threads interlace with each other at the middle of the fabric thickness. (A)

**Zigzag stitch:** Needle thread is pulled a little bit to the wrong side of the fabric.

If the machine is set to "Auto", it is suitable for most fabrics. However, adjustment may be necessary according to fabrics and sewing applications. If the tension is not correctly set, it will cause imbalanced stitch formation, puckering, and/or thread breakage.

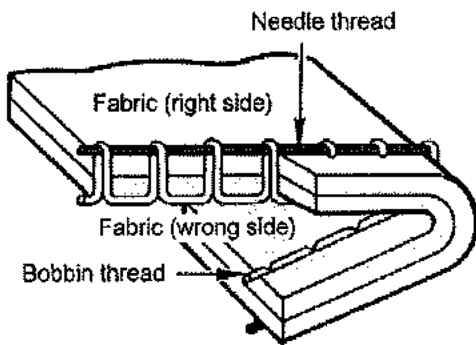
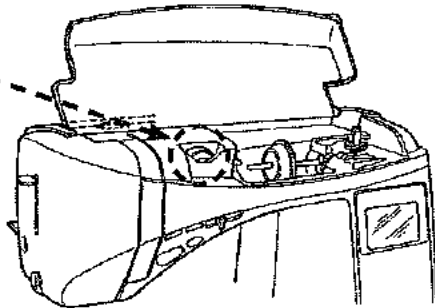
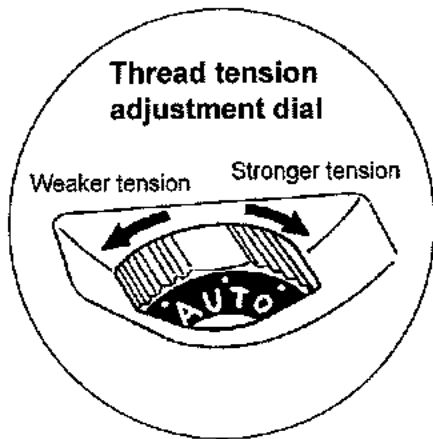

## When the needle thread is too strong:

The bobbin thread will be pulled to the front side of the fabric. Turn the thread tension adjustment dial towards "-1" to "-3".

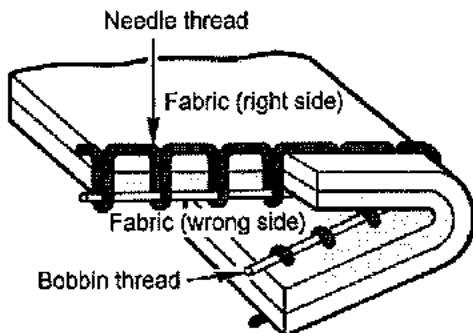

## When the needle thread is too low:

The needle thread will be pulled to the wrong side of fabric. Turn the thread tension adjustment dial towards "+1" to "+3".

In case a correct tension setting is not obtained, check thread paths for both needle and bobbin threads.

## How to adjust the presser foot pressure / How to lower the feed dog

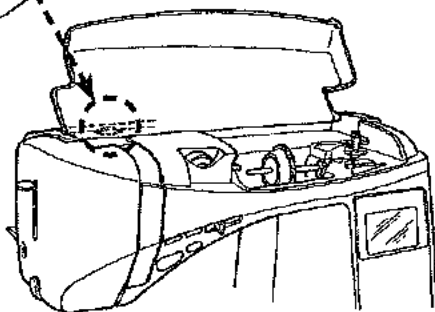
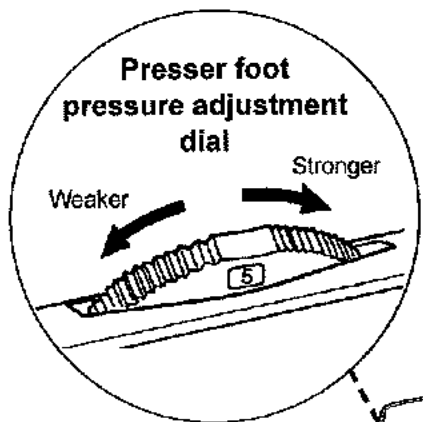

### ■ How to adjust presser foot pressure

Turn the presser foot pressure adjustment dial to set the proper pressure.

When sewing in general, set the presser foot pressure adjustment dial to "5".

When sewing on light synthetic fabrics, stretchy fabrics, appliqué which seam allowance is overlapped, etc., lower the number on the presser foot pressure adjustment dial. (reducing the presser foot pressure)

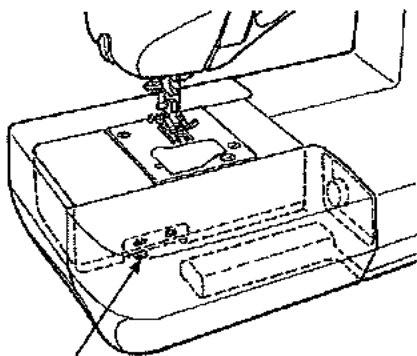

Drop feed knob

### ■ How to lower the feed dog

Move the drop feed knob to the right-hand side, in case the feed dog is in the down position for free motion quilting, button sewing, etc.

\* Move the drop feed knob to the left-hand side after sewing. The feed dog will be engaged automatically when the machine starts to sew.

#### ★ When lowering the feed dog

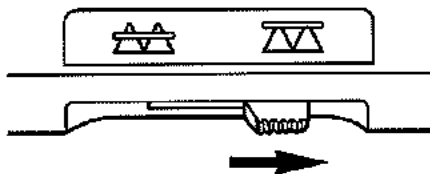

#### ★ When lifting the feed dog

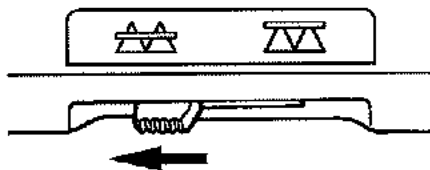

# How to select a stitch pattern

- ☆ There are 225 types of stitch patterns.
- ☆ When turning on the machine, the straight stitch of the center needle position is chosen automatically.
- ☆ There are 4 methods to select stitch pattern.

## 1 Direct patterns

Push and check the stitch pattern in this portion and select.

will be indicated on top right side of the screen.

| Pattern No.   | 1   | 2                          | 3                           | 4             | 5        | 6        | 7                   | 8            | 9                          | 0          |
|---------------|---|----------------------------|-----------------------------|---------------|----------|----------|---------------------|--------------|----------------------------|------------|
| Pattern       |   |                            |                             |               |          |          |                     |              |                            |            |
| Application   | Center needle position<br>Straight stitch | Piecing<br>Straight stitch | Straight stitch for elastic | Zigzag stitch | Applique | Applique | Over-casting stitch | Blind stitch | Straight reinforced stitch | Buttonhole |
| Refer to page | 33  | 63                         | 37                          | 38            | 64       | 65       | 39                  | 44           | 37                         | 44         |

On the LCD screen you will see the selected stitch pattern and the marking of the presser foot to be used.

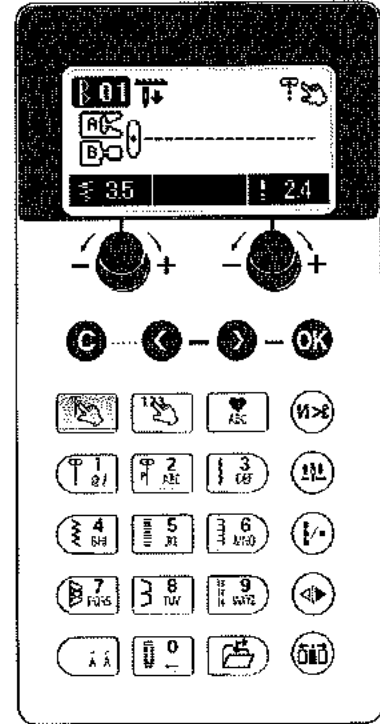

## 2 Other patterns

Push and choose stitch pattern type.

Select stitch pattern by number.

will be indicated on top right side of the screen.

### • Practical patterns

| Pattern No.   | 01                                      | 02  | 03                                    | 04                                     | 05                  | 06                | 07                 | 08  | 09   | 10  | 11  | 12   | 13         | 14                       | 15                 | 16         | 17       | 18     | 19     | 20      | 21            | 22 | 23 |
|---------------|---|---|---------------------------------------|--|---------------------|-------------------|--------------------|---|--|---|---|--|------------|--------------------------|--------------------|------------|----------|--------|--------|---------|---------------|----|----|
| Pattern       |   |   |                                       |  |                     |                   |                    |   |  |   |   |  |            |                          |                    |            |          |        |        |         |               |    |    |
| Application   | Left needle position<br>Straight stitch | Center needle position<br>Lock stitch (stay stitches) | Left needle position<br>Zigzag stitch | Right needle position<br>Zigzag stitch | Three point zig zag | Two point zig zag | Overcasting stitch | Overcasting stitch<br>Used for lightweight material | Overcasting stitch<br>Used for flexible material | Overcasting stitch<br>Used for lightweight material | Blind stitch<br>Used for lightweight material | Blind stitch<br>Used for flexible material | Shell tuck | Back straightline stitch | Back zigzag stitch | Fly stitch | Bar tack | Eyelet | Eyelet | Darning | Button sewing |    |    |
| Refer to page | 33                                      | 37  | 38                                    |  |                     |                   | 39, 40             |   |  |   |   |  | 41         |                          |                    | 37         |          |        | 52     |         |               | 71 |    |

• Buttonhole patterns

|               |                      |    |                   |             |                     |    |    |          |    |    |            |    |    |    |    |
|---------------|----------------------|----|-------------------|-------------|---------------------|----|----|----------|----|----|------------|----|----|----|----|
| Pattern No.   | 01                   | 02 | 03                | 04          | 05                  | 06 | 07 | 08       | 09 | 10 | 11         | 12 | 13 | 14 | 15 |
| Pattern       |                      |    |                   |             |                     |    |    |          |    |    |            |    |    |    |    |
| Application   | Standard buttonholes |    | 2-step buttonhole | Rounded end | Keyhole buttonholes |    |    | For knit |    |    | Decorative |    |    |    |    |
| Refer to page | 44~51                |    |                   |             |                     |    |    |          |    |    |            |    |    |    |    |

• Quilt patterns

|               |                          |    |    |    |    |    |    |    |    |    |    |    |    |    |    |    |    |
|---------------|--------------------------|----|----|----|----|----|----|----|----|----|----|----|----|----|----|----|----|
| Pattern       | 01                       | 02 | 03 | 04 | 05 | 06 | 07 | 08 | 09 | 10 | 11 | 12 | 13 | 14 | 15 | 16 | 17 |
| Pattern       |                          |    |    |    |    |    |    |    |    |    |    |    |    |    |    |    |    |
| Pattern       | Patterns for crazy quilt |    |    |    |    |    |    |    |    |    |    |    |    |    |    |    |    |
| Pattern       | 18                       | 19 | 20 | 21 | 22 | 23 | 24 | 25 | 26 | 27 | 28 | 29 | 30 | 31 | 32 | 33 | 34 |
| Pattern       |                          |    |    |    |    |    |    |    |    |    |    |    |    |    |    |    |    |
| Pattern       | 35                       | 36 | 37 | 38 | 39 | 40 | 41 | 42 | 43 | 44 | 45 | 46 | 47 | 48 | 49 | 50 | 51 |
| Pattern       |                          |    |    |    |    |    |    |    |    |    |    |    |    |    |    |    |    |
| Pattern       | 52                       | 53 | 54 | 55 | 56 | 57 | 58 | 59 | 60 | 61 | 62 | 63 | 64 | 65 | 66 | 67 |    |
| Pattern       |                          |    |    |    |    |    |    |    |    |    |    |    |    |    |    |    |    |
| Refer to page | 64~66                    |    |    |    |    |    |    |    |    |    |    |    |    |    |    |    |    |

• Decorative patterns

|               |    |    |    |    |    |    |    |    |    |    |    |    |    |    |    |    |    |    |
|---------------|----|----|----|----|----|----|----|----|----|----|----|----|----|----|----|----|----|----|
| Pattern       | 01 | 02 | 03 | 04 | 05 | 06 | 07 | 08 | 09 | 10 | 11 | 12 | 13 | 14 | 15 | 16 | 17 | 18 |
| Pattern       |    |    |    |    |    |    |    |    |    |    |    |    |    |    |    |    |    |    |
| Pattern       | 19 | 20 | 21 | 22 | 23 | 24 | 25 | 26 | 27 | 28 | 29 | 30 | 31 | 32 | 33 | 34 | 35 | 36 |
| Pattern       |    |    |    |    |    |    |    |    |    |    |    |    |    |    |    |    |    |    |
| Pattern       | 37 | 38 | 39 | 40 | 41 | 42 | 43 | 44 | 45 | 46 | 47 | 48 | 49 | 50 | 51 | 52 | 53 | 54 |
| Pattern       |    |    |    |    |    |    |    |    |    |    |    |    |    |    |    |    |    |    |
| Pattern       | 55 | 56 | 57 | 58 | 59 | 60 | 61 | 62 | 63 | 64 | 65 | 66 | 67 | 68 | 69 | 70 | 71 | 72 |
| Pattern       |    |    |    |    |    |    |    |    |    |    |    |    |    |    |    |    |    |    |
| Refer to page | 62 |    |    |    |    |    |    |    |    |    |    |    |    |    |    |    |    |    |

③ One point pattern

Push and choose and choose . Check the number in this portion and select. will be indicated on top right side of the screen.

|               |                         |    |    |    |    |    |    |    |    |    |    |    |    |    |    |  |
|---------------|-------------------------|----|----|----|----|----|----|----|----|----|----|----|----|----|----|--|
| Pattern       | 01                      | 02 | 03 | 04 | 05 | 06 | 07 | 08 | 09 | 10 | 11 | 12 | 13 | 14 | 15 |  |
| Pattern       |                         |    |    |    |    |    |    |    |    |    |    |    |    |    |    |  |
| Pattern       | 16                      | 17 | 18 | 19 | 20 | 21 | 22 | 23 |    |    |    |    |    |    |    |  |
| Pattern       |                         |    |    |    |    |    |    |    |    |    |    |    |    |    |    |  |
| Pattern       | Patterns for elongation |    |    |    |    |    |    |    |    |    |    |    |    |    |    |  |
| Pattern       | 24                      | 25 | 26 | 27 | 28 | 29 | 30 | 31 | 32 | 33 | 34 | 35 | 36 | 37 | 38 |  |
| Pattern       |                         |    |    |    |    |    |    |    |    |    |    |    |    |    |    |  |
| Refer to page | 71~78, 89               |    |    |    |    |    |    |    |    |    |    |    |    |    |    |  |

④ Letters

Push and choose and choose . Check this portion . Input letters by cell phone input. (Refer to page 73) will be indicated on top right side of the screen.

|               |        |        |        |        |        |        |        |  |
|---------------|--------|--------|--------|--------|--------|--------|--------|--|
| Pattern       | ABCDEF | ABCDEF | ABCDEF | ABCDEF | ABCDEF | ABCDEF | ABCDEF |  |
| Pattern       | abcdef | abcdef | abcdef | abcdef | abcdef | abcdef | abcdef |  |
| Pattern       | 123456 | 123456 | 123456 | 123456 | 123456 | 123456 | 123456 |  |
| Pattern       | @!&'AA | @!&'AA | @!&'AA | @!&'AA | @!&'AA | @!&'AA | @!&'AA |  |
| Pattern       | ABCDEF | ABCDEF | ABCDEF | ABCDEF | ABCDEF | ABCDEF | ABCDEF |  |
| Pattern       | abcdef | abcdef | abcdef | abcdef | abcdef | abcdef | abcdef |  |
| Pattern       | 123456 | 123456 | 123456 | 123456 | 123456 | 123456 | 123456 |  |
| Pattern       | @!&'AA | @!&'AA | @!&'AA | @!&'AA | @!&'AA | @!&'AA | @!&'AA |  |
| Refer to page | 71~78  |        |        |        |        |        |        |  |

# How to select a stitch pattern

- ☆ There are 157 types of stitch patterns.
- ☆ When turning on the machine, the straight stitch of the center needle position is chosen automatically.
- ☆ There are 4 methods to select stitch pattern.

## 1 Direct patterns

Push and check the stitch pattern in this portion and select.

will be indicated on top right side of the screen.

| Pattern No.   | 1   | 2                   | 3               | 4             | 5        | 6        | 7                   | 8            | 9                          | 0          |
|---------------|---|---------------------|-----------------|---------------|----------|----------|---------------------|--------------|----------------------------|------------|
| Pattern       |   |                     |                 |               |          |          |                     |              |                            |            |
| Application   | Center needle position<br>Straight stitch | Piecing for elastic | Straight stitch | Zigzag stitch | Applique | Applique | Over casting stitch | Blind stitch | Straight reinforced stitch | Buttonhole |
| Refer to page | 33  | 63                  | 37              | 38            | 64       | 65       | 39                  | 44           | 37                         | 44         |

On the LCD screen you will see the selected stitch pattern and the marking of the presser foot to be used.

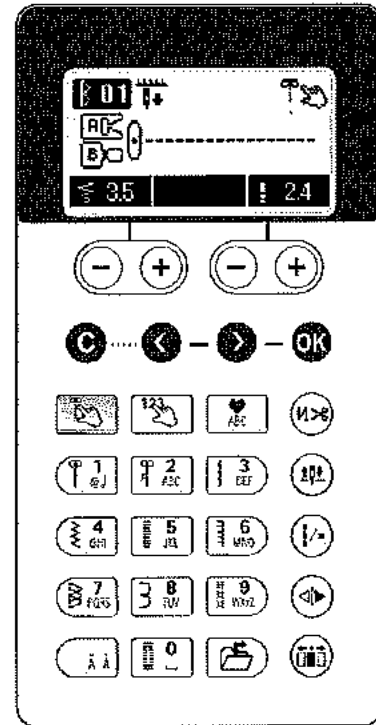

## 2 Other patterns

Push and choose stitch pattern type.

Select stitch pattern by number.

will be indicated on top right side of the screen.

### Practical patterns

| Pattern No.   | 01              | 02                          | 03            | 04            | 05                  | 06                | 07                 | 08  | 09   | 10  | 11   | 12                 | 13  | 14   | 15         | 16         | 17       | 18     | 19     | 20      | 21            |
|---------------|-----------------|-----------------------------|---------------|---------------|---------------------|-------------------|--------------------|---|--|---|--|--------------------|---|--|------------|------------|----------|--------|--------|---------|---------------|
| Pattern       |                 |                             |               |               |                     |                   |                    |   |  |   |  |                    |   |  |            |            |          |        |        |         |               |
| Application   | Straight stitch | Lock stitch (stay stitches) | Zigzag stitch | Zigzag stitch | Three point zig zag | Two point zig zag | Overcasting stitch | Overcasting stitch<br>Used for lightweight material | Overcasting stitch<br>Used for flexible material | Overcasting stitch<br>Used for lightweight material | Overcasting stitch<br>Used for flexible material | Ornamental pattern | Blind stitch<br>Used for lightweight material | Blind stitch<br>Used for flexible material | Shell tuck | Fly stitch | Bar tack | Eyelet | Eyelet | Darning | Button sewing |
| Refer to page | 33              | 37                          | 38            | 38            |                     |                   | 39, 40             | 39, 40  |  |   |  | -                  | 41  | 41   | -          | -          | 52       | -      | -      | 71      | -             |

• Buttonhole patterns

| Pattern No    | 01                   | 02 | 03                | 04          | 05                  | 06 | 07 | 08       | 09 | 10 | 11         | 12 | 13 | 14 | 15 |
|---------------|----------------------|----|-------------------|-------------|---------------------|----|----|----------|----|----|------------|----|----|----|----|
| Pattern       |                      |    |                   |             |                     |    |    |          |    |    |            |    |    |    |    |
| Application   | Standard buttonholes |    | 2-step buttonhole | Rounded end | Keyhole buttonholes |    |    | For knit |    |    | Decorative |    |    |    |    |
| Refer to page | 44-51                |    |                   |             |                     |    |    |          |    |    |            |    |    |    |    |

• Quilt patterns

|               |       |    |    |    |    |    |    |    |    |    |
|---------------|-------|----|----|----|----|----|----|----|----|----|
| Pattern       | 01    | 02 | 03 | 04 | 05 | 06 | 07 | 08 | 09 | 10 |
|               | 11    | 12 | 13 | 14 | 15 | 16 | 17 | 18 | 19 | 20 |
|               | 21    | 22 | 23 | 24 | 25 | 26 | 27 | 28 | 29 |    |
| Refer to page | 64-66 |    |    |    |    |    |    |    |    |    |

• Decorative patterns

|               |    |    |    |    |    |    |    |    |    |    |    |    |    |
|---------------|----|----|----|----|----|----|----|----|----|----|----|----|----|
| Pattern       | 01 | 02 | 03 | 04 | 05 | 06 | 07 | 08 | 09 | 10 | 11 | 12 | 13 |
|               | 14 | 15 | 16 | 17 | 18 | 19 | 20 | 21 | 22 | 23 | 24 | 25 | 26 |
|               | 27 | 28 | 29 | 30 | 31 | 32 | 33 | 34 | 35 | 36 | 37 | 38 | 39 |
|               | 40 | 41 | 42 | 43 | 44 | 45 | 46 | 47 | 48 | 49 |    |    |    |
| Refer to page | 62 |    |    |    |    |    |    |    |    |    |    |    |    |

③ One point pattern

Push and choose

Check the number in this portion

and select.

will be indicated on top right side of the screen.

|               |           |    |    |    |    |    |    |    |    |    |    |    |
|---------------|-----------|----|----|----|----|----|----|----|----|----|----|----|
| Pattern       | 01        | 02 | 03 | 04 | 05 | 06 | 07 | 08 | 09 | 10 | 11 |    |
|               | 12        | 13 | 14 | 15 | 16 | 17 | 18 | 19 | 20 | 21 | 22 | 23 |
|               | 24        | 25 | 26 | 27 | 28 | 29 | 30 | 31 | 32 | 33 |    |    |
| Refer to page | 71-78, 89 |    |    |    |    |    |    |    |    |    |    |    |

④ Letters

Push and choose

Check this portion.

Input letters by cell phone input. (Refer to page 73)

will be indicated on top right side of the screen.

|               |             |             |
|---------------|-------------|-------------|
| Pattern       | A B C D E F | A B C D E F |
|               | a b c d e f | a b c d e f |
|               | 1 2 3 4 5 6 | 1 2 3 4 5 6 |
|               | @ ! & ' A A | @ ! & ' A A |
| Refer to page | 71-78       |             |

# How to select a stitch pattern

- ☆ There are 105 types of stitch patterns.
- ☆ When turning on the machine, the straight stitch of the center needle position is chosen automatically.
- ☆ There are 4 methods to select stitch pattern.

## 1 Direct patterns

Push and check the stitch pattern in this portion and select.

will be indicated on top right side of the screen.

| Pattern No.   | 1  | 2  | 3                           | 4             | 5        | 6        | 7                  | 8            | 9                          | 0          |
|---------------|--|----|-----------------------------|---------------|----------|----------|--------------------|--------------|----------------------------|------------|
| Pattern       |  |    |                             |               |          |          |                    |              |                            |            |
| Application   | Center needle position<br>Piecing<br>Straight stitch |    | Straight stitch for elastic | Zigzag stitch | Applique | Applique | Overcasting stitch | Blind stitch | Straight reinforced stitch | Buttonhole |
| Refer to page | 33   | 63 | 37                          | 38            | 64       | 65       | 39                 | 44           | 37                         | 44         |

On the LCD screen you will see the selected stitch pattern and the marking of the presser foot to be used.

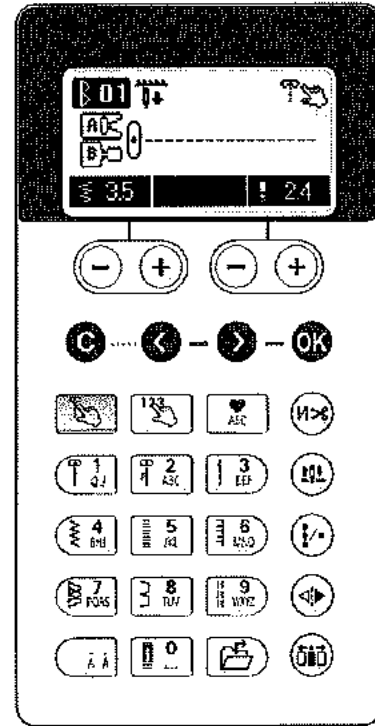

## 2 Other patterns

Push and choose stitch pattern type.

Select stitch pattern by number.

will be indicated on top right side of the screen.

### Practical patterns

| Pattern No.   | 01              | 02                          | 03            | 04            | 05                  | 06                | 07                 | 08                 | 09                 | 10                 | 11                 | 12                 | 13           | 14           | 15         | 16         | 17       | 18     | 19     | 20      | 21            |
|---------------|-----------------|-----------------------------|---------------|---------------|---------------------|-------------------|--------------------|--------------------|--------------------|--------------------|--------------------|--------------------|--------------|--------------|------------|------------|----------|--------|--------|---------|---------------|
| Pattern       |                 |                             |               |               |                     |                   |                    |                    |                    |                    |                    |                    |              |              |            |            |          |        |        |         |               |
| Application   | Straight stitch | Lock stitch (stay stitches) | Zigzag stitch | Zigzag stitch | Three point zig zag | Two point zig zag | Overcasting stitch | Overcasting stitch | Overcasting stitch | Overcasting stitch | Ornamental pattern | Ornamental pattern | Blind stitch | Blind stitch | Snell tuck | Fly stitch | Bar tack | Eyelet | Eyelet | Darning | Button sewing |
| Refer to page | 33              | 37                          | 38            | 38            |                     |                   |                    | 39, 40             |                    |                    |                    |                    | 41           |              |            |            | 52       |        |        | 71      |               |



• Buttonhole patterns



|               |                      |    |                   |             |                     |    |    |          |    |    |            |    |    |    |    |
|---------------|----------------------|----|-------------------|-------------|---------------------|----|----|----------|----|----|------------|----|----|----|----|
| Pattern No.   | 01                   | 02 | 03                | 04          | 05                  | 06 | 07 | 08       | 09 | 10 | 11         | 12 | 13 | 14 | 15 |
| Pattern       |                      |    |                   |             |                     |    |    |          |    |    |            |    |    |    |    |
| Application   | Standard buttonholes |    | 2-step buttonhole | Rounded end | Keyhole buttonholes |    |    | For knit |    |    | Decorative |    |    |    |    |
| Refer to page | 44~51                |    |                   |             |                     |    |    |          |    |    |            |    |    |    |    |

• Quilt patterns



|               |       |    |    |    |    |    |    |    |    |    |    |
|---------------|-------|----|----|----|----|----|----|----|----|----|----|
| Pattern       | 01    | 02 | 03 | 04 | 05 | 06 | 07 | 08 | 09 | 10 | 11 |
|               |       |    |    |    |    |    |    |    |    |    |    |
|               | 12    | 13 | 14 | 15 | 16 | 17 | 18 | 19 | 20 | 21 | 22 |
|               |       |    |    |    |    |    |    |    |    |    |    |
| Refer to page | 64~66 |    |    |    |    |    |    |    |    |    |    |

• Decorative patterns



|               |    |    |    |    |    |    |    |    |    |    |
|---------------|----|----|----|----|----|----|----|----|----|----|
| Pattern       | 01 | 02 | 03 | 04 | 05 | 06 | 07 | 08 | 09 | 10 |
|               |    |    |    |    |    |    |    |    |    |    |
|               | 11 | 12 | 13 | 14 | 15 | 16 | 17 | 18 | 19 | 20 |
|               |    |    |    |    |    |    |    |    |    |    |
| Refer to page | 62 |    |    |    |    |    |    |    |    |    |

③ One point pattern

Push and choose . Check the number in this portion and select. will be indicated on top right side of the screen.

|               |           |    |                         |    |    |    |    |    |    |    |    |    |
|---------------|-----------|----|-------------------------|----|----|----|----|----|----|----|----|----|
| Pattern       | 01        | 02 | 03                      | 04 | 05 | 06 | 07 | 08 | 09 | 10 |    |    |
|               |           |    |                         |    |    |    |    |    |    |    |    |    |
|               | 11        | 12 | Patterns for elongation |    |    |    | 13 | 14 | 15 | 16 | 17 | 18 |
|               |           |    |                         |    |    |    |    |    |    |    |    |    |
| Refer to page | 71~78, 89 |    |                         |    |    |    |    |    |    |    |    |    |

④ Letters

Push and choose . Check this portion. Input letters by cell phone input. (Refer to page 73) will be indicated on top right side of the screen.

|               |             |             |
|---------------|-------------|-------------|
| Pattern       | A B C D E F | A B C D E F |
|               | a b c d e f | a b c d e f |
|               | 1 2 3 4 5 6 | 1 2 3 4 5 6 |
|               | @ ! & ' Ä Å | @ ! & ' Ä Å |
|               | A B C D E F | A B C D E F |
|               | a b c d e f | a b c d e f |
|               | 1 2 3 4 5 6 | 1 2 3 4 5 6 |
|               | @ ! & ' Ä Å | @ ! & ' Ä Å |
| Refer to page | 71~78       |             |

# Straight stitch

|  |  |
|--|--|
|  |  |
|  | <b>Pattern No.</b> Direct 1<br><b>Presser foot</b> Standard presser foot (A)<br><b>Thread tension</b> Auto |

## ⚠ Attention

Turn off the machine before replacing the presser foot.

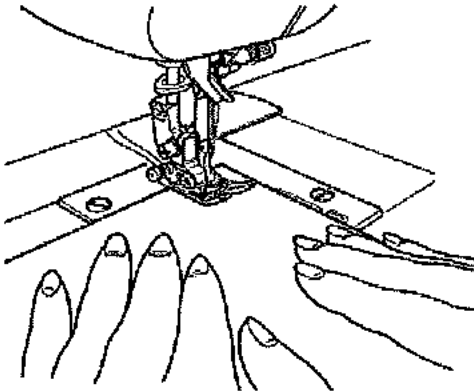

## ■ Sewing start

Pull the needle and bobbin threads under the presser foot to the rear of the machine and lower the presser foot to start sewing.

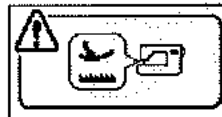

This means presser foot is up. Lower the presser foot to start sewing.

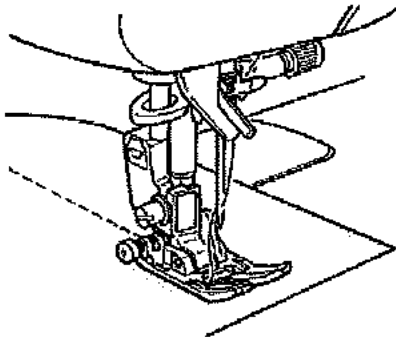

## ■ Sewing end

Stop sewing and push the thread trimming button to trim the threads.

<by thread trimming button>

Push the thread trimming button to trim the threads.

<by foot controller>

Push heel side of the foot controller to trim the threads.

\* This function can be cancelled.  
(Refer to page 82.)

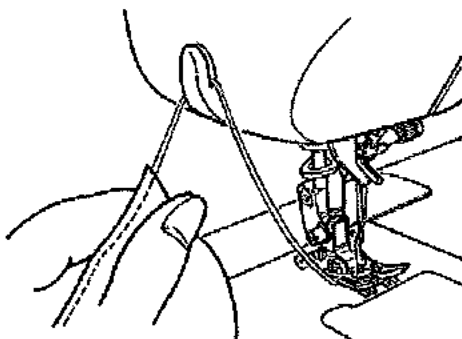
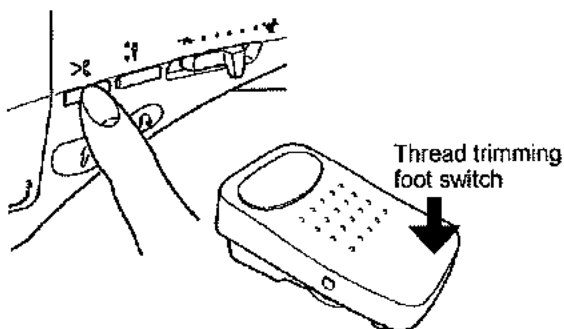

\* You can also cut the threads by the thread cutter at the face plate cover.

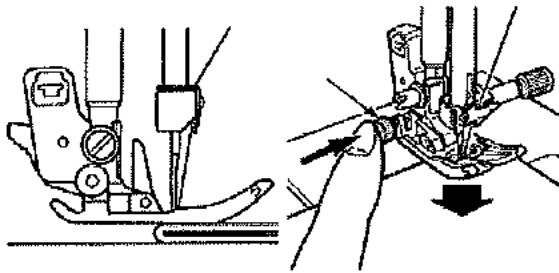

## ■ When sewing the edge of thick fabrics

Turn the hand wheel and let the needle enter at the position of sewing start. Push the black button by finger and lower the presser foot. Release the finger from the black button and start sewing. When the presser foot will be on the fabric completely, the black button will be disengaged automatically.

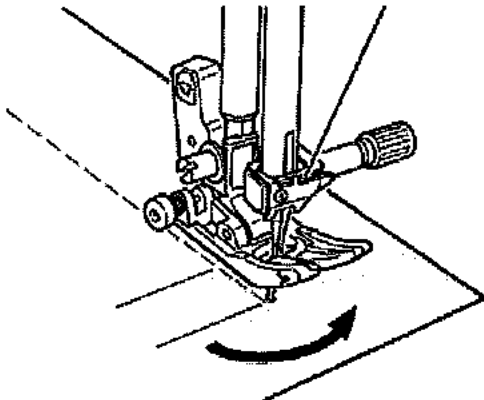

## ■ When changing the sewing direction

Stop sewing in front of the predetermined position and then continue to sew, stitch by stitch, by using needle up/down button until the target point. Leave the needle inside the fabrics and raise the presser foot. With the needle inside the fabrics change the sewing direction, lower the presser foot and then start sewing.

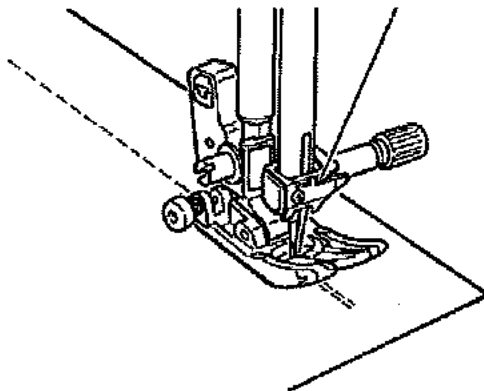

## ■ Lock stitch after sewing-end

<When start/stop button is used>

After the sewing is finished, push the reverse stitch button. While it is pressed, the machine will sew reverse and when it is released, the machine will stop sewing reverse.

\*When reverse stitching, the sewing speed is slow.

<When foot controller is used>

The machine will sew reverse at almost the same speed as the normal sewing. When the reverse stitch button is released, the machine sews straight.

On center needle position basis

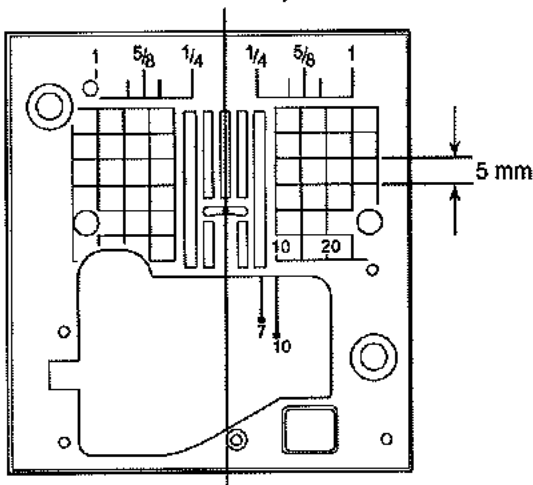

## ★ Seam guide line on the throat plate

Align the fabric edge with a seam guide line and sew.

\* Numbers on the guide line show the distance in mm and inches between the center needle position and the guide line.

Numbers, 7, 10 and 20 are millimeter.

Numbers, 1/4, 5/8 and 1 are inches.

## ★ Automatic lock stitch and thread trimming

After selecting a stitch pattern, push  one time.



The machine will sew a few reverse stitches (lock stitches), trim both needle and bobbin threads and stop.

Symbol on screen: 

When  is pushed once again, this function will be cancelled.

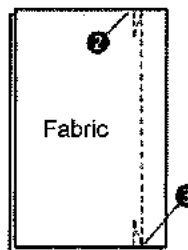
Example: straight stitch



- 1** After selecting a pattern, you can press  to display  on the screen.

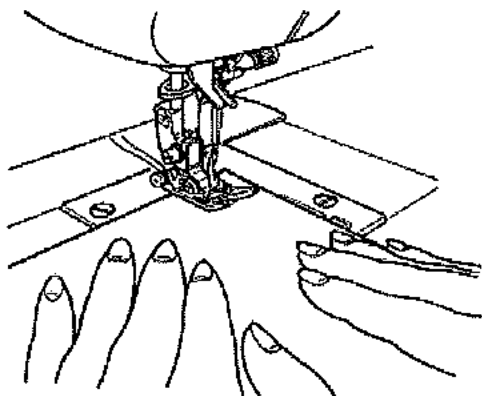

- 2** Place the fabric in the sewing start position and begin sewing.

The machine sews a few back stitches and continue.

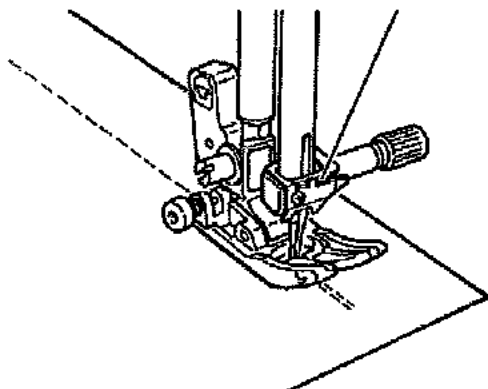

- 3** Press the reverse stitch button.

The machine sews reverse stitches, stop sewing and trim both needle and bobbin threads automatically.

## ★ How to change needle positions / How to change the stitch length

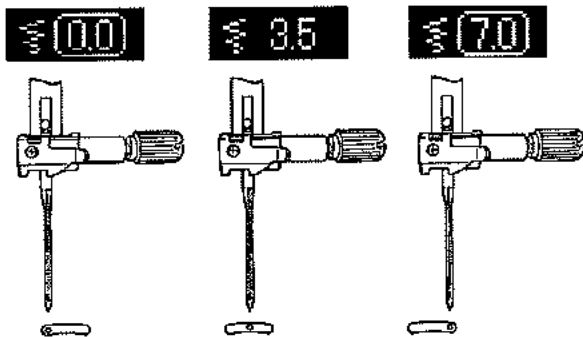
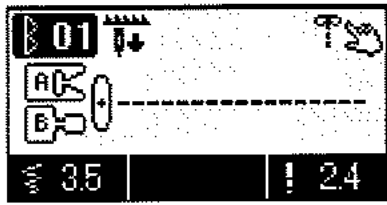

### ■ When changing the needle position of straight stitch

It is possible to change the needle position with the zigzag width adjusting dial/button.

**F600 Only**

Turning to the left (- side), the needle moves to the left.  
Turning to the right (+ side), the needle moves to the right.

**F400 / F300**

Pushing "-", the needle moves to the left.  
Pushing "+", the needle moves to the right.

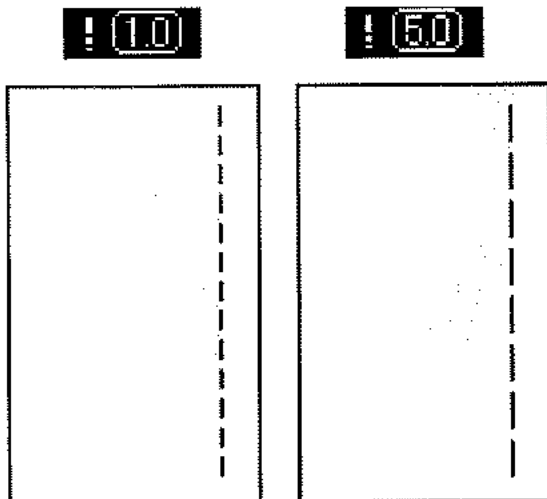
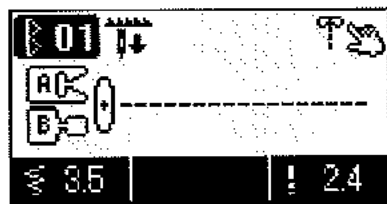

### ■ When changing the stitch length

It is possible to change the stitch length with the stitch length adjusting dial/button.

**F600 Only**

Turning to the left (- side), the displayed value becomes smaller and the stitch length becomes smaller accordingly.  
Turning to the right (+ side), the displayed value becomes larger and the stitch length becomes larger.

**F400 / F300**

Pushing "-", the displayed value becomes smaller and the stitch length becomes smaller accordingly.  
Pushing "+", the displayed value becomes larger and the stitch length becomes larger.



## ★ Other straight stitch patterns

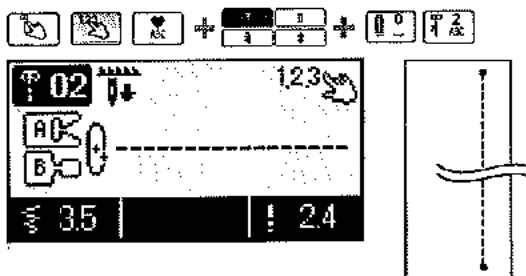

### ■ Lock stitch (stay stitches)

[When using start/stop button]

When stitching is coming to the end, push the reverse stitch button. The machine will sew stay stitches while the button is pushed.

[When the foot controller is used]

When stitching is coming to the end, push the reverse stitch button. The machine will sew stay stitches while the reverse stitch button is pushed, and will start to sew straight when the button is released.

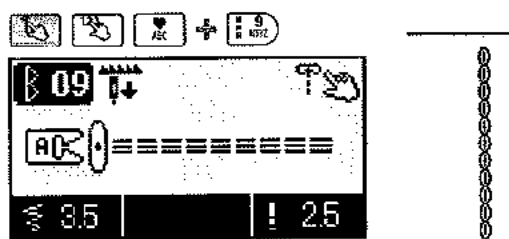

### ■ Reinforced stretch stitch

The reinforcing stretch stitch helps reinforce seams when used for sewing of elastic fabric or the force-exerted part of fabric that is likely to fray.

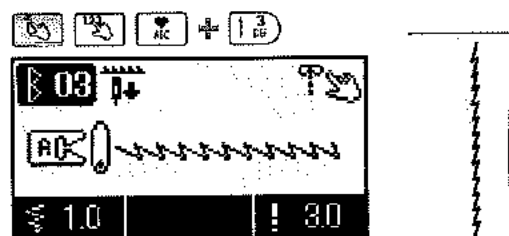

### ■ Straight stitch for elastic fabric

Finished seams are elastic. This stitch system can be used for producing straight stitches on elastic fabrics such as knits and jersey.

F600 Only

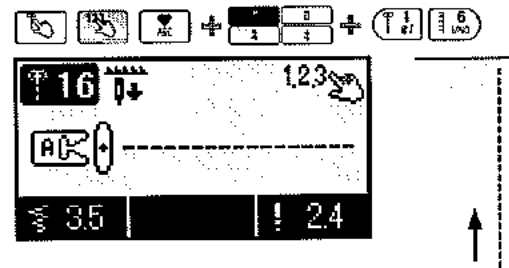

### ■ Reverse straight stitch

Machine starts to sew reverse and when reverse stitch button is pushed, it sews forward.

# Zigzag stitch

|  |   |
|--|---|
|  |   |
|  | <b>Pattern No.</b> Direct 4                   |
|  | <b>Presser foot</b> Standard presser foot (A) |

## ⚠ Attention

Turn off the power before replacing the presser foot.

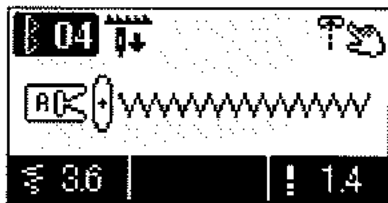

3.6

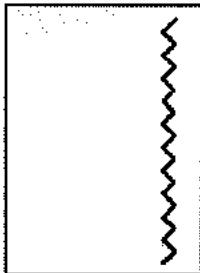

7.0

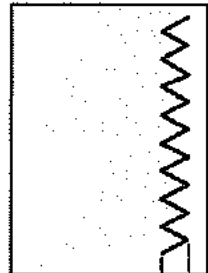

Width

## ■ When changing the zigzag width

The zigzag width can be adjusted while sewing.

### F600 Only

Turning to the left (- side), displayed value becomes smaller and the zigzag width becomes smaller accordingly.

Turning to the right (+ side), displayed value becomes larger and the zigzag width becomes larger accordingly.

### F400 / F300

Pushing "-", displayed value becomes smaller and the zigzag width becomes smaller accordingly.

Pushing "+", displayed value becomes larger and the zigzag width becomes larger accordingly.

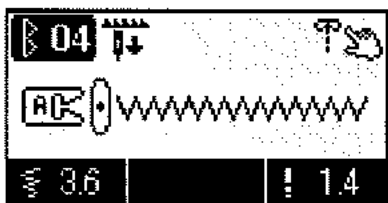
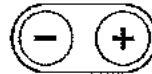

1.0

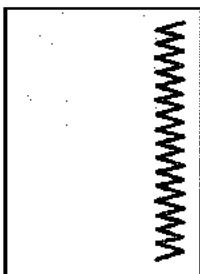

1.50

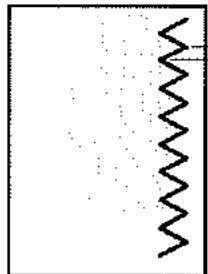

Length

## ■ When changing the stitch length

The stitch length can be adjusted while sewing.

### F600 Only

Turning to the left (- side), the displayed value becomes smaller and the stitch length becomes smaller accordingly.

Turning to the right (+ side), the displayed value becomes larger and the stitch length becomes larger accordingly.

### F400 / F300

Pushing "-", the displayed value becomes smaller and the stitch length becomes smaller accordingly.

Pushing "+", the displayed value becomes larger and the stitch length becomes larger accordingly.



# Overcasting stitch

This stitch is used to prevent the edge of fabric from fraying.

## Overcasting stitch 1

|  |  |
|--|--|
|  |  |
|  | <b>Pattern No.</b> Direct 7                      |
|  | <b>Presser foot</b> Overcasting presser foot (C) |
|  |  |

### Attention

Turn off the power before replacing the presser foot.

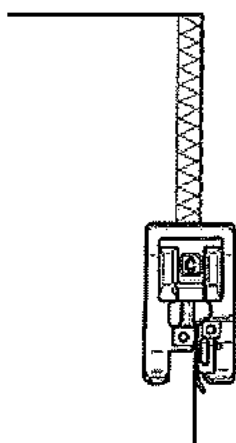

Push the fabric towards the guide and sew. If the fabric and guide are apart, it will not make a nice stitch formation. Make sure to guide the fabric along the guide and sew slowly.

\* Before sewing, make sure to check that the needle will not hit the presser foot.

## Overcasting stitch 2

|  |  |
|--|--|
|  |  |
|  | <b>Pattern No.</b> Practical 07                  |
|  | <b>Presser foot</b> Overcasting presser foot (C) |
|  |  |

### Attention

Turn off the power before replacing the presser foot.

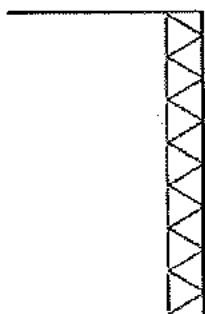

This stitch is used for overcasting medium- to heavy-weight materials. Guide the fabric along the guide and sew.

\* Before sewing, make sure to check that the needle will not hit the presser foot.



### Overcasting stitch 3

|  |   |
|--|---|
|  |   |
|  | <b>Pattern No.</b> Practical 08 (Light-weight material)<br><b>Presser foot</b> Overcasting presser foot (C) |

**Attention**  
 Turn off the power before replacing the presser foot.

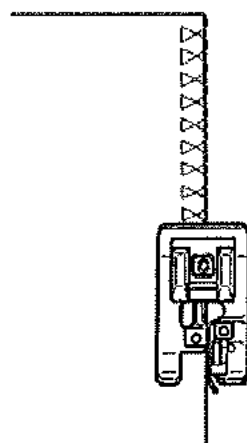

This overcasting stitch is used for overcasting light-weight materials.  
 Guide the fabric along the guide and sew.

\* Before sewing, make sure to check that the needle will not hit the presser foot.

### Overcasting by 3-point zigzag

|  |  |
|--|--|
|  |  |
|  | <b>Pattern No.</b> Practical 05<br><b>Presser foot</b> Standard presser foot (A) |





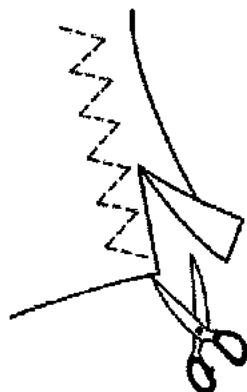





**Attention**  
 Turn off the power before replacing the presser foot.

\* Do not use overcasting presser foot (C).

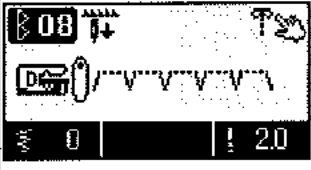

This stitch is used to prevent the cut edge of fabric from fraying.  
 Keep some seam allowance and cut the sewn fabric carefully so that stitches are not cut by the scissors.

# Blind stitch

|   |   |   |   |   |   |                |
|---|---|---|---|---|---|----------------|
|  |  |                          | + |  |   |                |
|  |  |                          | + |  | + | Pattern number |
|  |   | <b>Pattern No.</b><br>Direct 8<br>Practical 13 (Light-weight material)<br>Practical 14 (Stretchy fabrics) |   |   |   |                |
|  |   | <b>Presser foot</b><br>Blind stitch presser foot (D)  |   |   |   |                |

## ⚠ Attention

Turn off the power before replacing the presser foot.

## ■ Folding fabrics

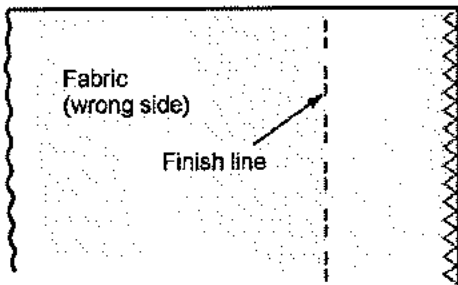

### 1 Sewing overcasting stitches on the edge of fabric.

- Refer to pages 39 and 40 for overcasting stitches.

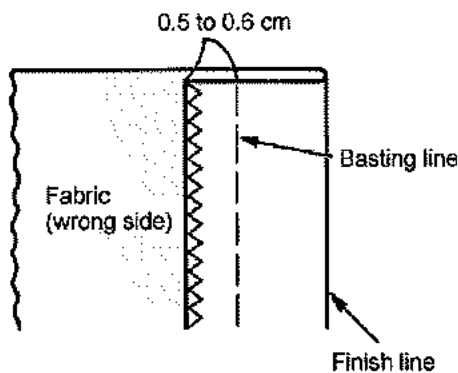

### 2 Basting.

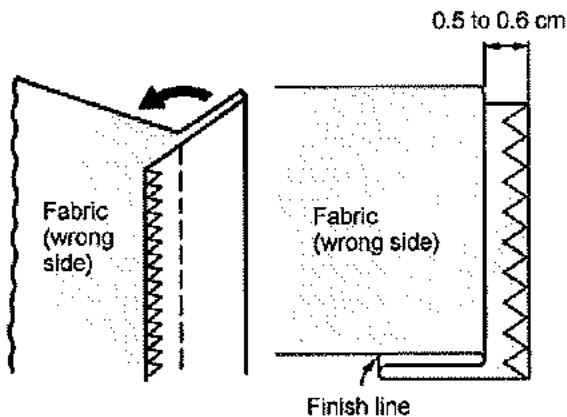

### 3 Fold from basting line.

- Leave 0.5 to 0.6 cm.

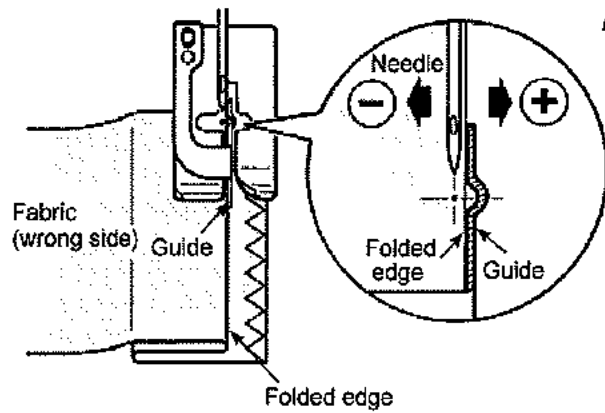

**4** Align the guide of the presser foot with the folded edge.  
Turn the hand wheel and adjust with the zigzag width adjusting dial so that stitches reach the folded edge.

\* Pay attention so that needle will not hit the presser foot.

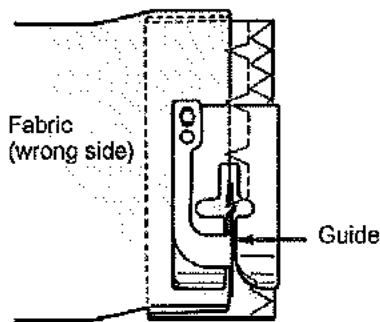

**5** Position the folded edge against the guide and sew.

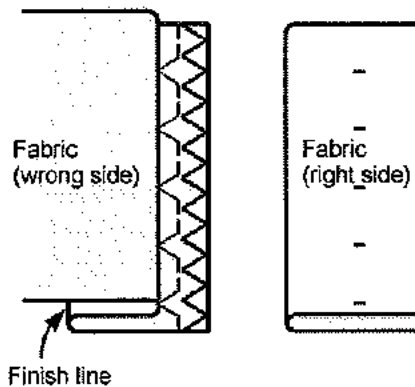

**6** Turn over the fabric after sewing.



## ■ When changing the needle entry point

### 1. If the stitches reach too far beyond the folded edge

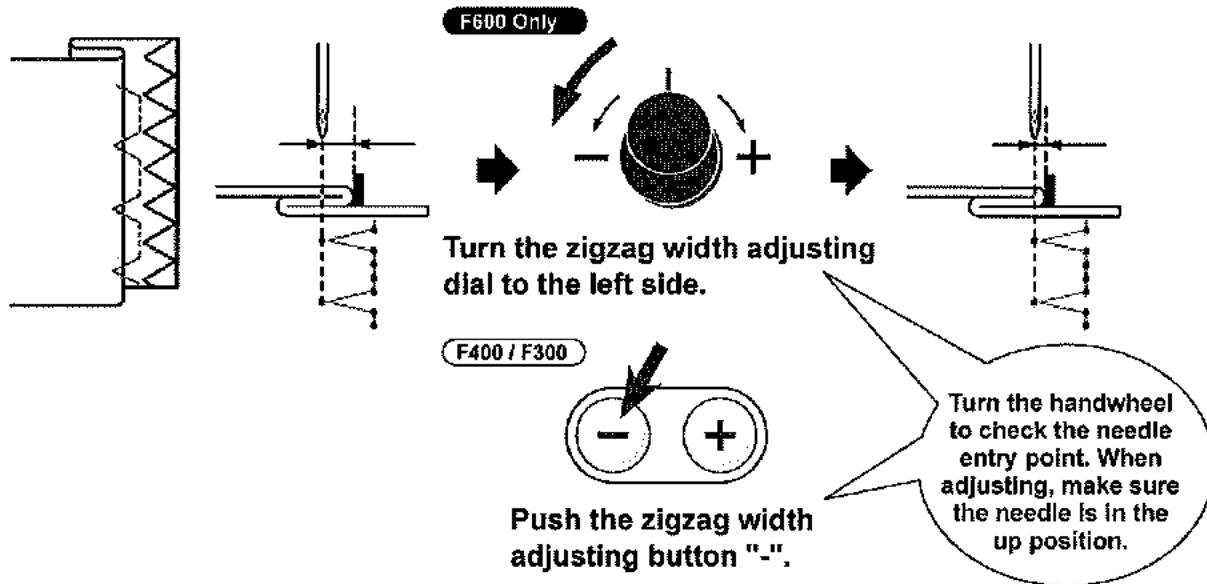

### 2. If the stitches fail to reach the folded edge

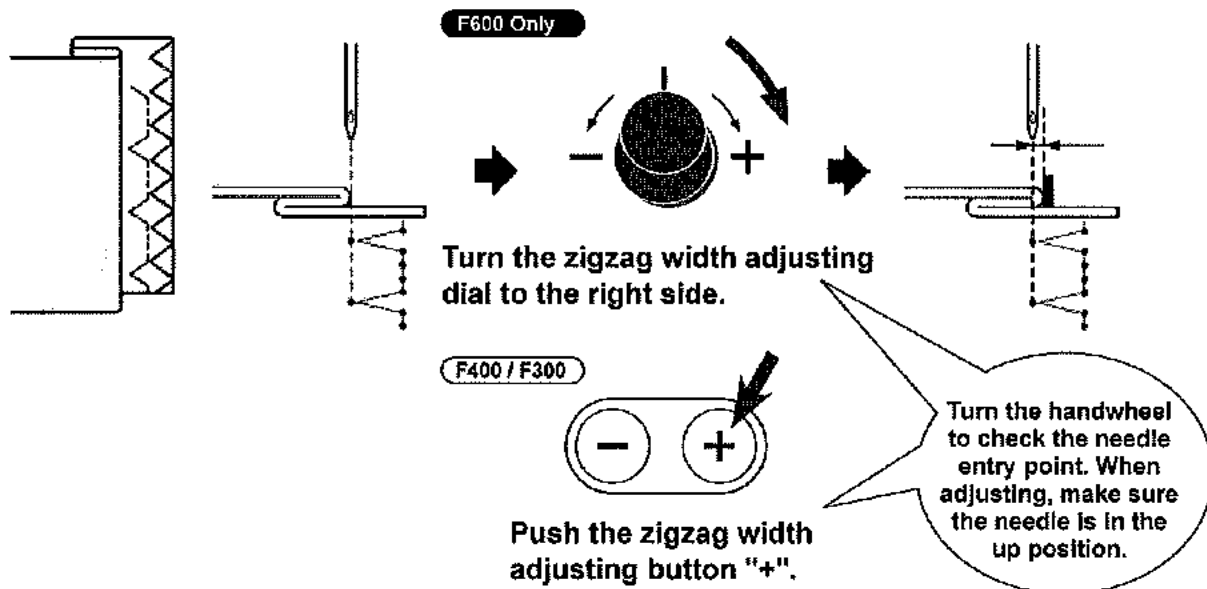

# Buttonhole stitches

|  |  |  |   |  |   |  |                |
|--|--|--|---|--|---|--|----------------|
|  |  |  | + |  |   |  |                |
|  |  |  | + |  | + |  | Pattern number |

|  |              |   |
|--|--------------|---|
|  | Pattern No.  | Direct 0<br>Buttonhole 01, 02,<br>04~15 |
|  | Presser foot | Buttonhole presser<br>foot (E)          |

## Attention

Turn off the power before replacing the presser foot.

- \* The buttonhole length is automatically determined only by placing a button on the buttonhole presser foot.
- \* The machine can sew buttonholes for buttons with diameters of 0.7 - 3.2 cm.
- \* In case of stretchy fabrics, use non-elastic interlining on the wrong side of the fabric.
- \* Make sure to perform test sewing to see that the machine sews buttonholes correctly.
- \* Buttonhole Nos. 09 - 12 are for knit fabrics and should be used with a knit needle.

## Buttonhole type

|    |  |                     |  |
|----|--|---------------------|--|
| 0  |  | Standard buttonhole | Buttonhole for medium to heavy weight materials<br>Standard buttonhole   |
| 01 |  |                     | Stitch length is larger.<br>Buttonhole for heavy weight materials  |
| 02 |  |                     | Sews buttonhole double   |
| 03 |  |                     | Manual 2-step buttonhole<br>Use this buttonhole, when there is an overlapped section in the fabric or when you want to sew larger buttonhole than 3.2cm diameter. (Refer to page 50) |
| 04 |  | Rounded end         | Buttonholes for women's blouses and children's clothes.<br>Also for light weight materials   |
| 05 |  |                     |  |
| 06 |  | Keyhole             | Keyhole buttonhole for heavy weight materials such as suits, jackets, coats, etc.  |
| 07 |  |                     | Round keyhole  |
| 08 |  |                     | Large and thick keyholes for heavy weight materials  |

|    |  |            |   |
|----|--|------------|---|
| 09 |  | For knit   | Buttonhole for light weight knit (also used as decorative buttonhole)     |
| 10 |  |            | Buttonhole for medium weight knit (also used as decorative buttonhole)    |
| 11 |  |            | Buttonhole for light weight knit<br>Sews buttonhole double                |
| 12 |  |            | Buttonhole for medium weight knit<br>Sews double buttonhole               |
| 13 |  | Decorative | Decorative buttonholes<br>Decorative buttonhole which look like hand-sewn |
| 14 |  |            |   |
| 15 |  |            |   |

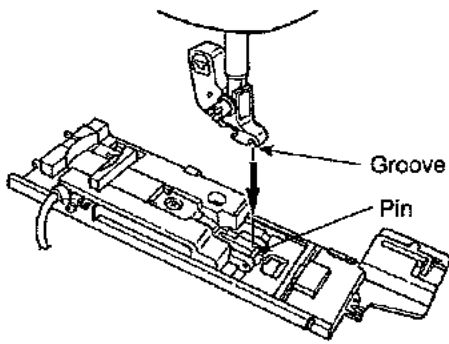

## 1 Set the presser foot.

Push the needle up/down button to raise the needle and lift the presser foot.  
Align the groove of the presser foot holder with the pin of the presser foot and lower the presser foot holder to set.

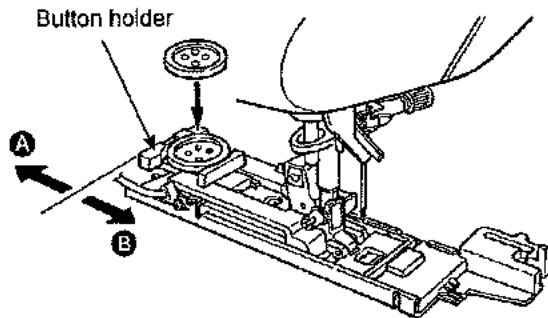

## 2 Set the button.

Pull the button holder toward **A**, place the button on the button holder, and then push the holder toward **B** to set the buttonhole length.

\* It is impossible to set a button thicker than 4mm.

\* Check the following points after setting the presser foot and then start to sew buttonholes.

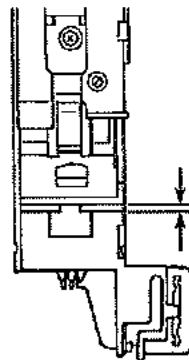

Check that there is a clearance.

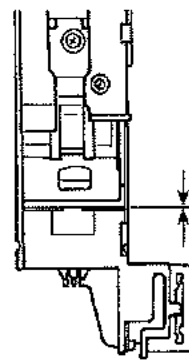

If there is not a clearance, the machine will not sew neat stitches.

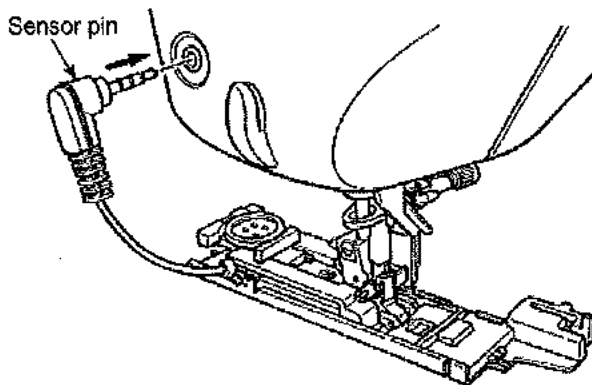

## 3 Set the buttonhole sensor pin.

Insert the sensor pin into the sensor pin hole at the face plate cover.

\* Insert the pin into the hole completely.

\* If the machine starts to sew without inserting the pin into the hole, the following message will be shown on the display.

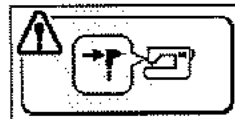

Set the sensor pin and restart.

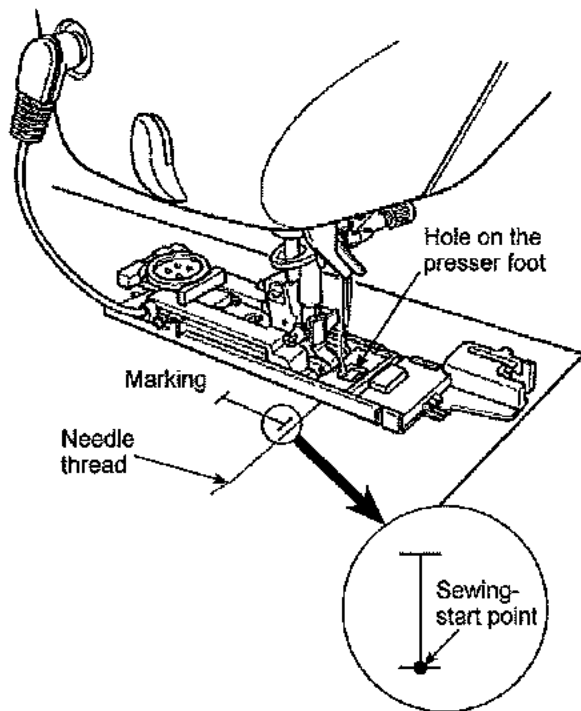

## 4 Place the fabric under the presser foot.

Raise the presser foot, pass the needle thread through the hole on the presser foot and pull it out sideways. Place the fabric under the presser foot, align the marking with the sewing-start point. Penetrate the needle into the fabric by turning the hand wheel and lower the presser foot.

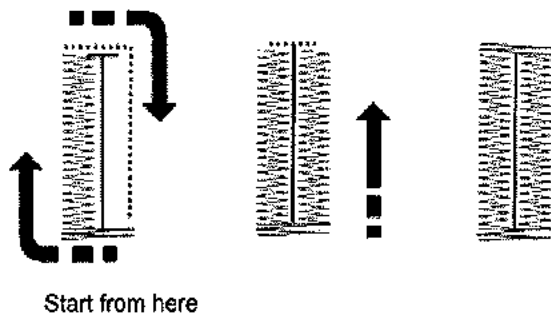

## 5 Start sewing.

The machine will stop automatically after sewing the buttonhole.

- \* If a buttonhole of the same size will be sewn again, push the thread trimming button to trim the threads and raise the presser foot. Under this condition move to another point, lower the presser foot and then start sewing.
- \* Do not change stitch length and/or zigzag width during buttonholing. Otherwise this will cause imbalanced stitches.
- \* If thread trimming button is pushed while sewing buttonhole, the machine will stop and will not complete the buttonhole.
- \* Depending on material to be sewn and weaving direction of the material, there might be a slight difference in zigzag widths between right and left lines of buttonholes. Test sewing is recommended.

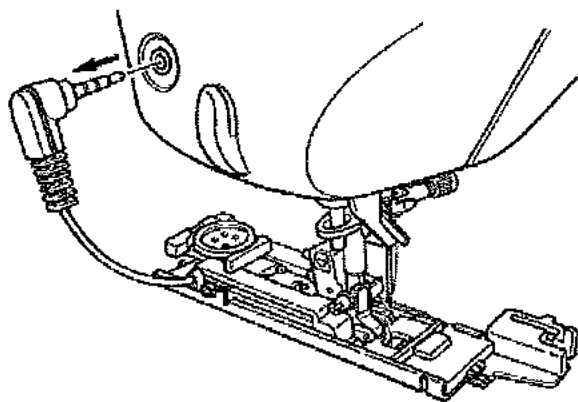

**6** Unplug the sensor pin after sewing.

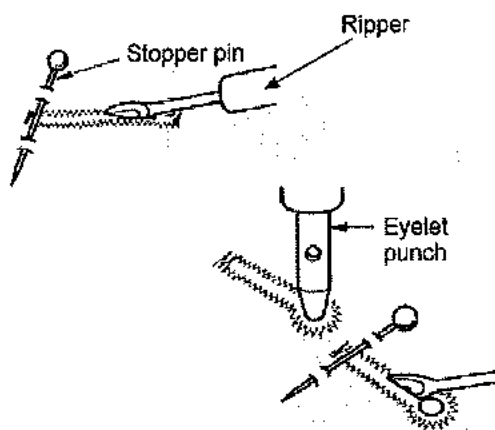

**7** Opening the buttonhole using a ripper.

**[double bartack]**

Pierce a stopper pin at the bartack and open the buttonhole with a ripper. Be careful not to cut the stitches.

**[Keyhole buttonhole]**

Place a cardboard under the buttonhole and make a hole with the eyelet punch. Then pierce a stopper pin at the bartack and open the buttonhole with a ripper.

### ● Buttonhole clamping plate

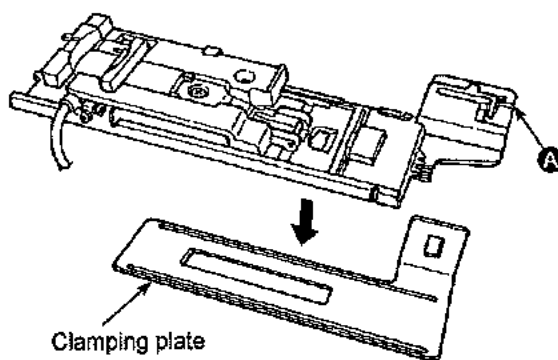

**⚠ Caution**

Turn off the power when setting the clamping plate.

It will be easier to sew buttonholes on the thin fabrics and/or near the overlapped sections, if the clamping plate is used.

1. Attach the buttonhole presser foot to the presser foot holder, with the clamping plate together.
2. Place the fabric between the presser foot and the clamping plate.

\* You can remove the clamping plate by holding **A**.



## ■ Buttonhole with gimp

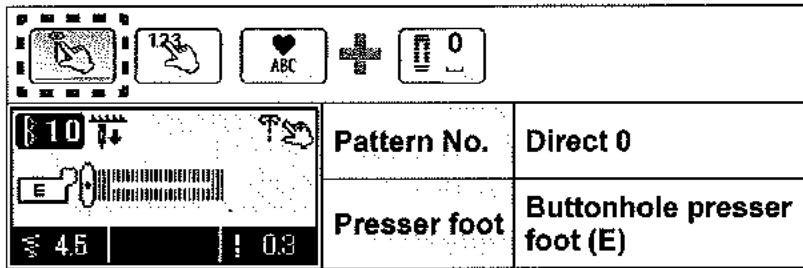

### ⚠ Attention

Turn off the power before replacing the presser foot.

Buttonholes with gimp thread prevent the buttonholes from stretching and can make them more secure. Use thread such as hand-sewn buttonholes and similar for gimp thread.

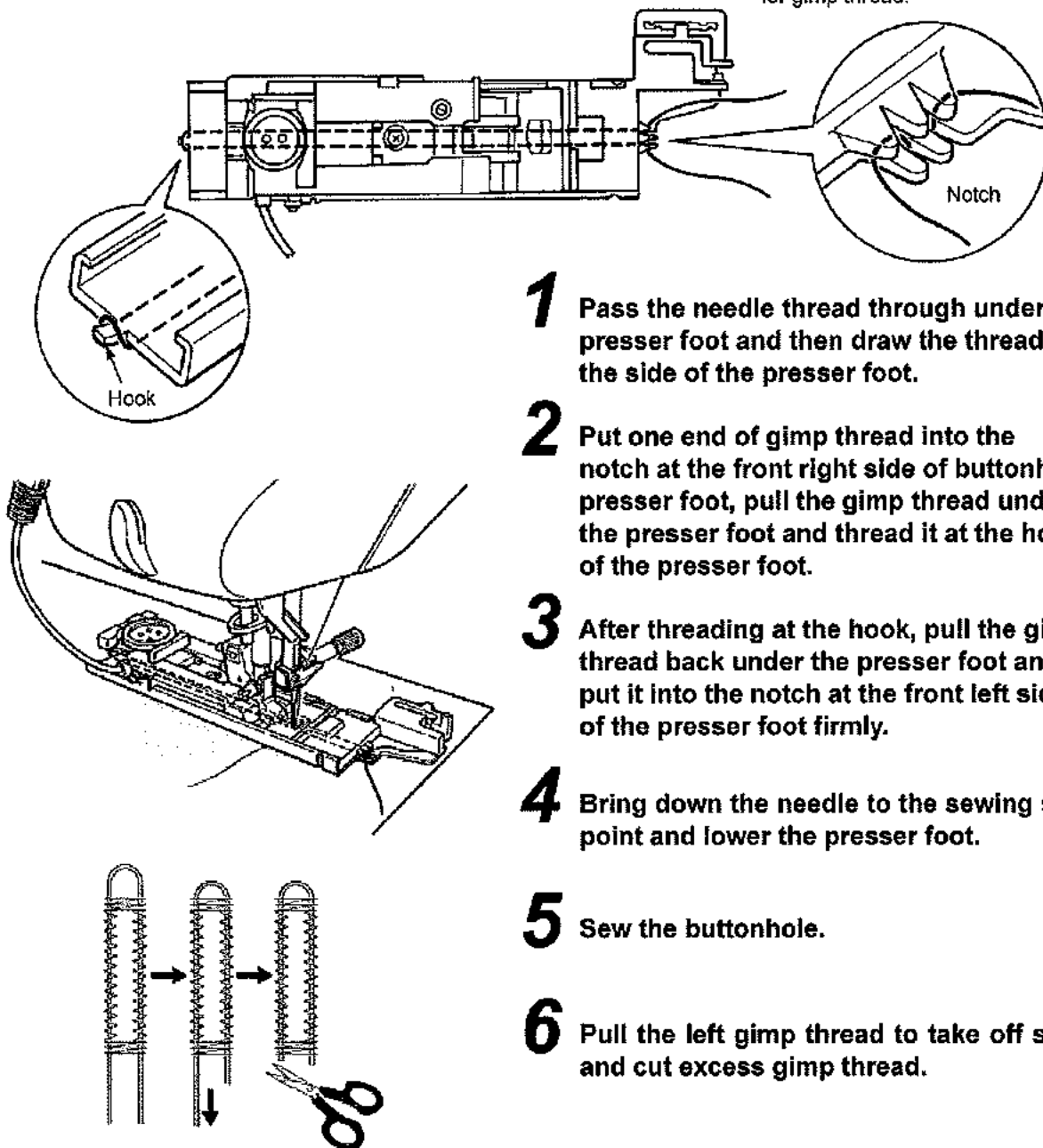

**1** Pass the needle thread through under the presser foot and then draw the thread to the side of the presser foot.

**2** Put one end of gimp thread into the notch at the front right side of buttonhole presser foot, pull the gimp thread under the presser foot and thread it at the hook of the presser foot.

**3** After threading at the hook, pull the gimp thread back under the presser foot and put it into the notch at the front left side of the presser foot firmly.

**4** Bring down the needle to the sewing start point and lower the presser foot.

**5** Sew the buttonhole.

**6** Pull the left gimp thread to take off slack and cut excess gimp thread.

## ■ When changing the width of the buttonhole

Turn the zigzag width adjusting dial/button.

\* The setting of the buttonhole width and stitch length will be cancelled when the power is shut down or another pattern is selected.

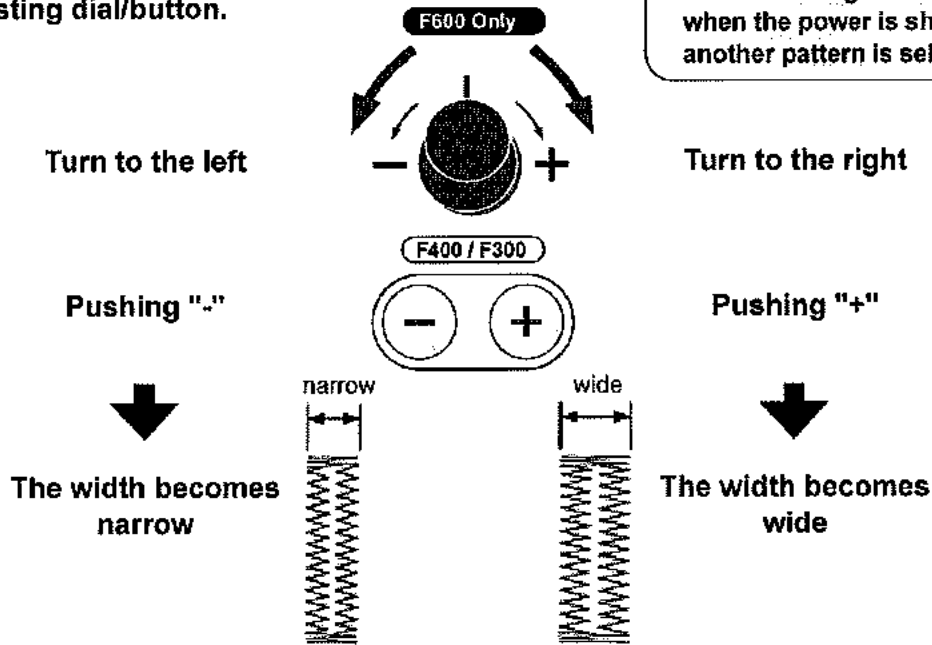

## ■ When changing the density of the seam

Turn the stitch length adjusting dial/button.

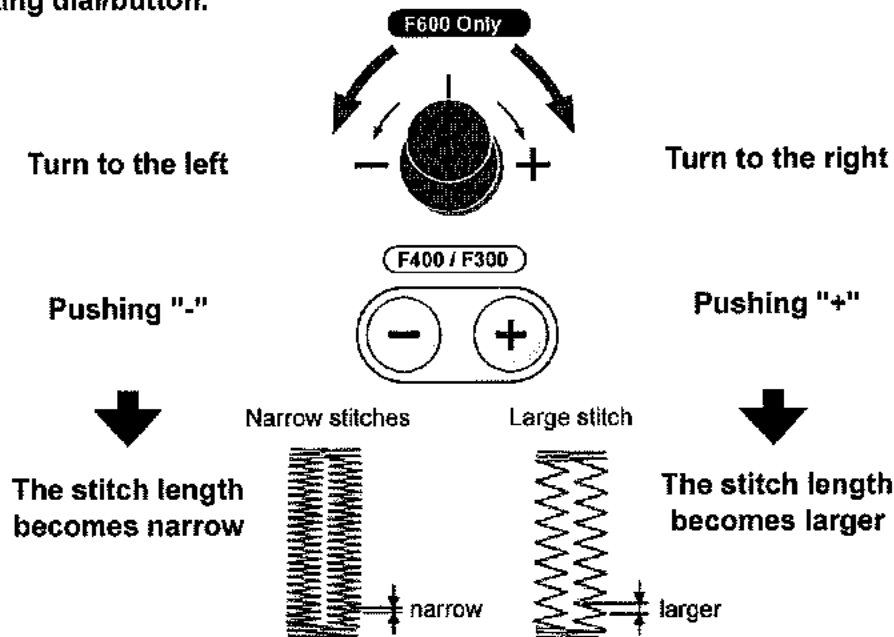

\* The width of buttonhole can be changed by (  ) option. (Refer to page 80)

## Manual 2-step buttonhole

|  |  |
|--|--|
|  |  |
|  | <b>Pattern No.</b> Buttonhole 03                       |
|  | <b>Presser foot</b> Manual buttonhole presser foot (I) |

### ⚠ Attention

Turn off the power before replacing the presser foot.

\* Turn the "zigzag width" and "stitch length" adjusting dials before sewing when you want to change the buttonhole width and density of the seam.

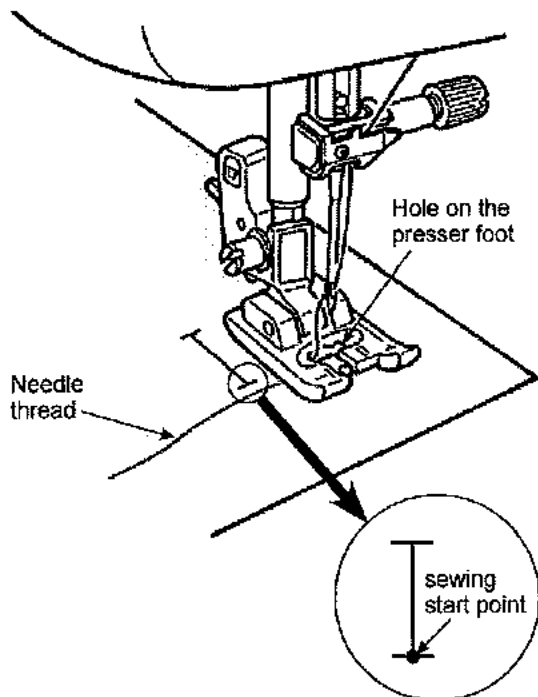

**1** Set the manual buttonhole presser foot (I).

**2** Pass the needle thread through the hole of the presser foot and pull it out sideways together.

**3** Bring down the needle on the sewing start point and lower the presser foot.

**4** Push start/stop button to sew.

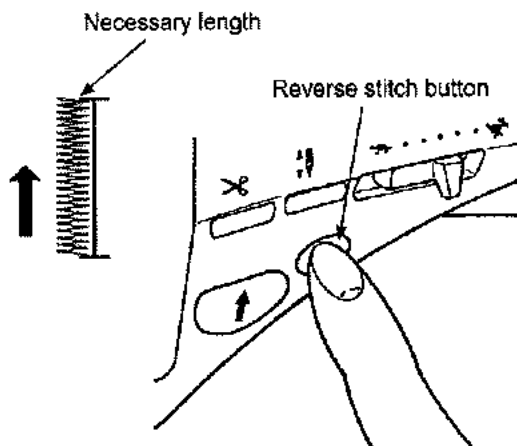

\* At this time, if the start/stop button is pushed, the machine will stop sewing. And if the start/stop button is pushed again, then the machine will continue to sew the left side of the buttonhole.

Push the reverse stitch button when it reaches the necessary length of the left side of the buttonhole.

Sew bartack and the right side of the buttonhole, then the machine sews bartack and right side of the buttonhole.

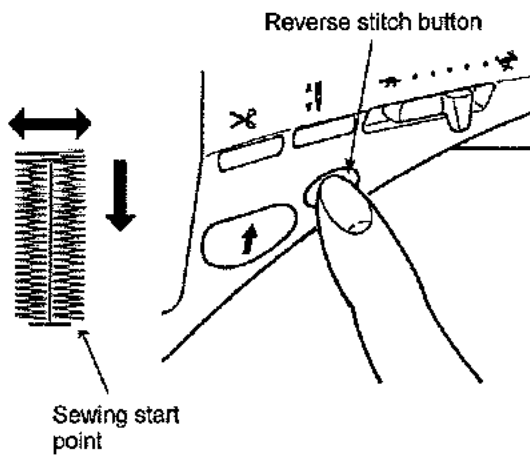

**5** Push reverse stitch button when it comes to the sewing start point.



**6** Sew bartack and lock stitches until the machine stops automatically.

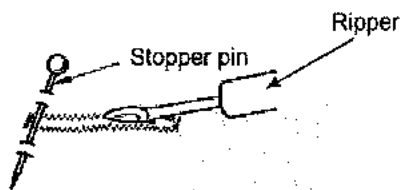

**7** Pierce a stopper pin at the bartack and open the buttonhole with a ripper. Be careful not to cut the stitches.

As the numbers of stitches of both right and left lines of buttonhole is memorized in the sewing machine, the buttonhole of the same size can be sewn.

\* If you want to change the memory, select the stitch pattern once again.

\* In the case of a 2-step buttonhole, sewing direction of the left and that of the right side is different. Due to this and according to fabrics to be sewn, it may be possible that the density of each side looks different.

# Bartacking

|  |  |
|--|--|
|  |  |
|  | <b>Pattern No.</b> Practical 19 <b>F600</b><br>Practical 17 <b>F400 / F300</b> |
|  | <b>Presser foot</b> Manual buttonhole<br>presser foot (I)                      |

**Attention**  
 Turn off the power before replacing the presser foot.

Bartacking is used to reinforce the part of the seam that is likely to ravel.

\* The length of the bartack is determined by pushing the reverse stitch button, but it will automatically make a u-turn when it reaches the maximum of 20 stitches.

\* If the presser foot cannot be parallel to throat plate, use filler fabric or cardboard.

## example of use

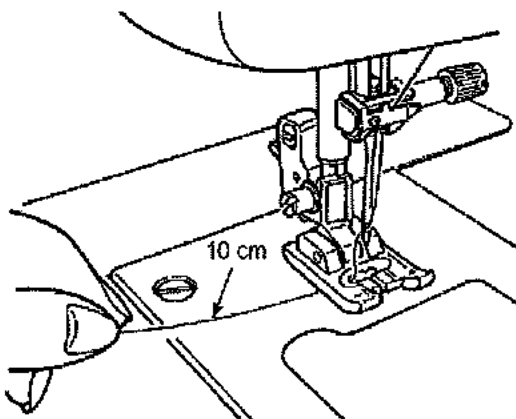
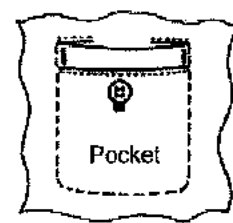

**1** Pass the needle thread through the presser foot.

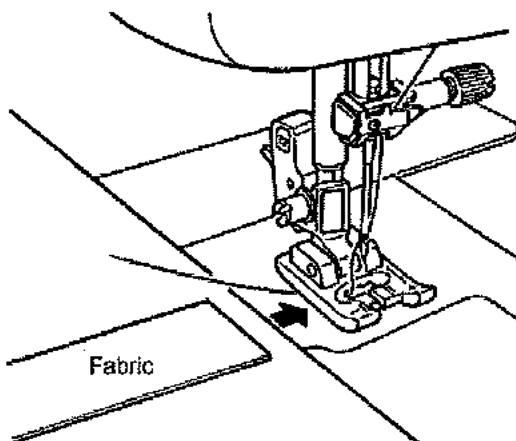

**2** Place the fabric under the presser foot.

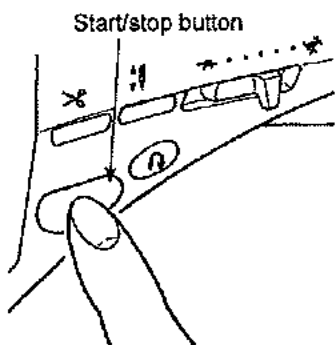
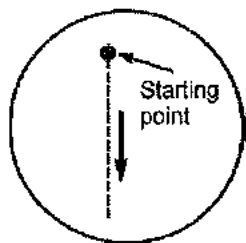

### 3 Start sewing.

Push the start/stop button and the machine starts to sew straight stitches.

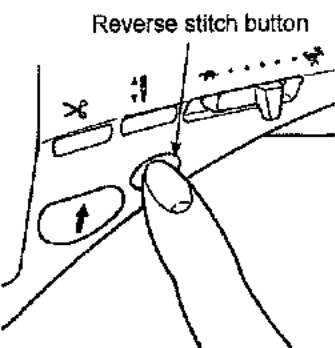
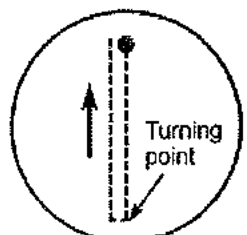

### 4 When it comes to the turning point push the reverse stitch button.

The machine goes back to the starting point by sewing straight stitches and then it sews zigzag stitches to the point where the reverse stitch button is pushed.

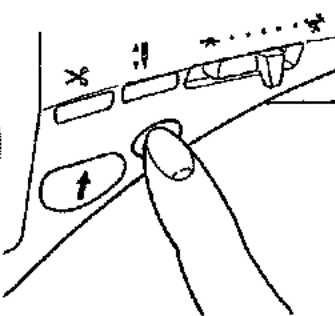
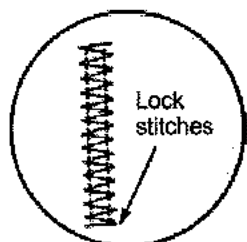
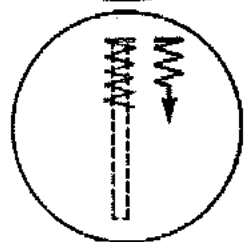

### 5 When the machine comes to the sewing end point, push the reverse stitch button.

The machine sews lock stitches and stops.

**To sew a bartack of the same length again...  
when the length of the first bartack has been memorized,**

- When the start/stop button is pushed, the machine starts to sew and makes a u-turn automatically at the same point as the first bartack.

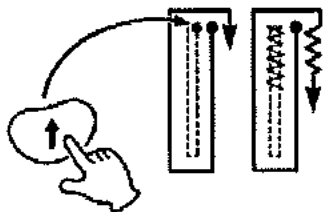

- When it comes to the sewing end point, push the reverse stitch button.

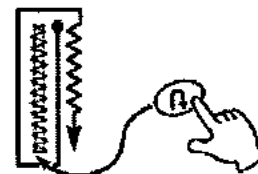

\* If you want to change the memorized length of the bar tack, please select stitch pattern again.

# Inserting zippers

|  |   |
|--|---|
|  |   |
|  | <b>Pattern No.</b> Direct 1                 |
|  | <b>Presser foot</b> Zipper presser foot (B) |

## ⚠ Attention

Turn off the power before replacing the presser foot.

Zippers are set in two different ways: by inserting into the side seam of the garment and by centering in position.

\* Make sure to use center needle position (Stitch pattern No. Direct 1).

## ■ Preparation before attaching zipper

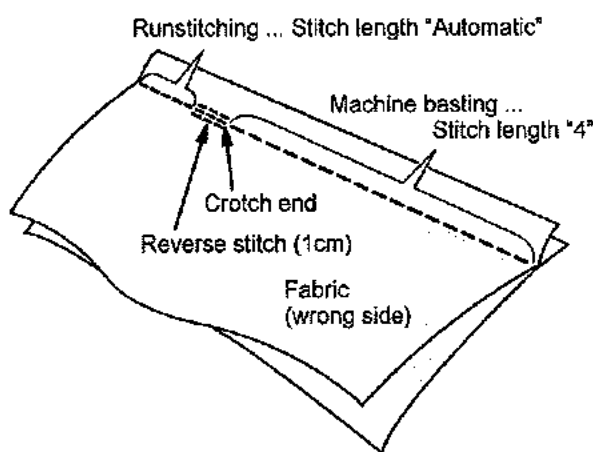

### 1 Use the standard presser foot (A) to sew.

Place the fabrics face-to-face. Check the runstitching length and the length of the zipper to be inserted. Machine baste the zipper onto the fabrics.

Machine basting = zipper opening length + 1 cm

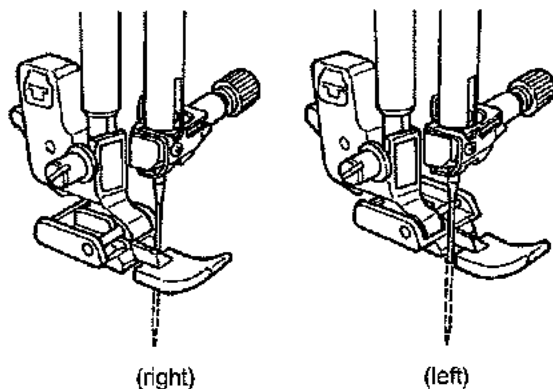

### 2 Attach the zipper presser foot (B) to the machine.

When sewing the left side of the zipper, place the zipper under the right portion of the zipper presser foot. When sewing the right side of the zipper, place the zipper under the left portion of the foot.

## ■ Lapped insertion

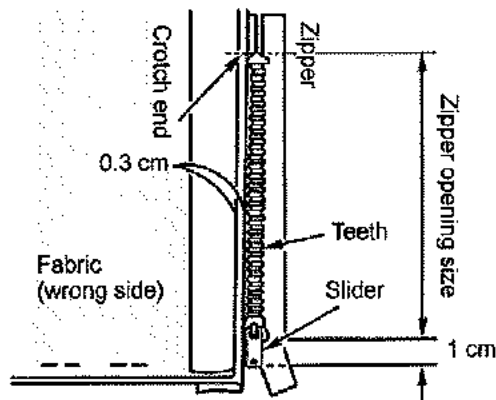

### 1 Open the seam allowance.

Neatly open the seam allowance. Adjust the back seam allowance so that it projects 3 mm from the seam. Press with an iron to make a crease. Fit the crease along the edge of the teeth.

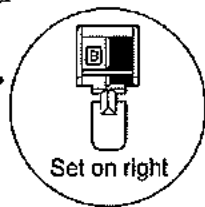
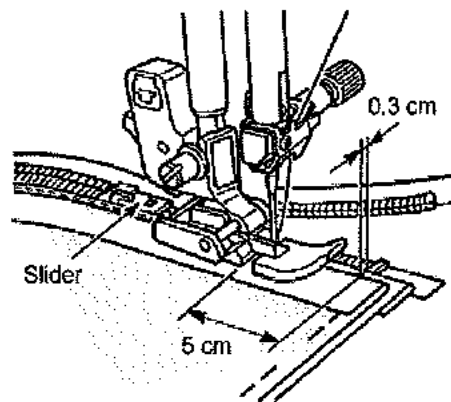

### 2 Sew the zipper tape on the seam allowance from bottom to top.

Fitting the edge of the zipper presser foot along the edge of the zipper teeth, sew the zipper tape on the seam allowance. At the slider part of the zipper, stop the machine at 5 cm (2 inches) before the slider. Move the slider to the far side of the presser foot and sew the zipper until its top end is reached.

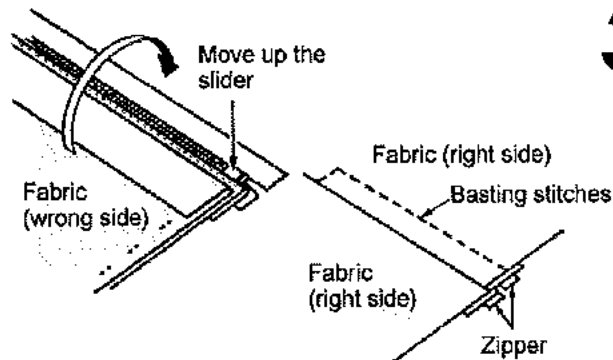

### 3 Put the fabric over the zipper. Baste the zipper and set it on the fabric.

\* Baste the zipper tape with the fabric with hand basting stitches. Move the slider to the top of the zipper. Put the fabric over the zipper and perform basting.

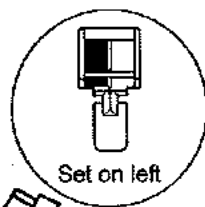
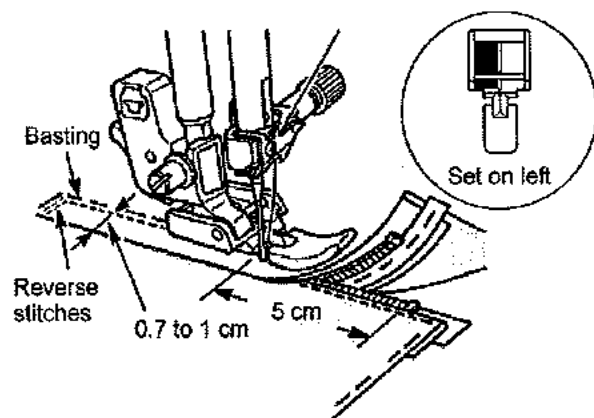

### 4 Sew reverse stitches and sew the right-hand side.

After sewing reverse stitches, set the left hand side of the zipper presser foot to the zipper teeth. Sew until 5 cm (2 inches) of the zipper end. Undo the basting stitches and move the slider to the far end of the presser foot. Then sew the rest of the way.



## ■ Centered insertion

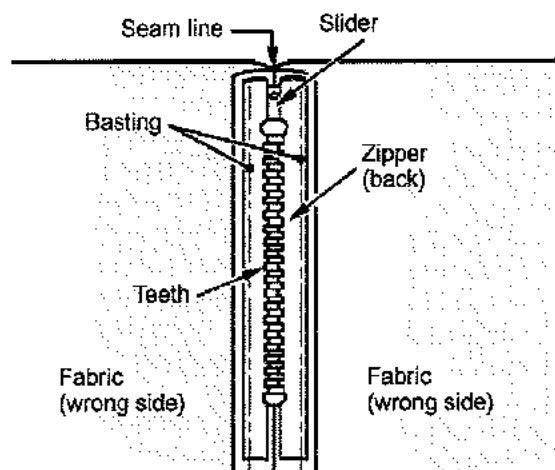

### 1 Baste zipper and garment body.

Open the seam allowance. Fit the teeth of the zipper at the end of the seam line and perform basting by hand. Pull the slider tab to the up side.

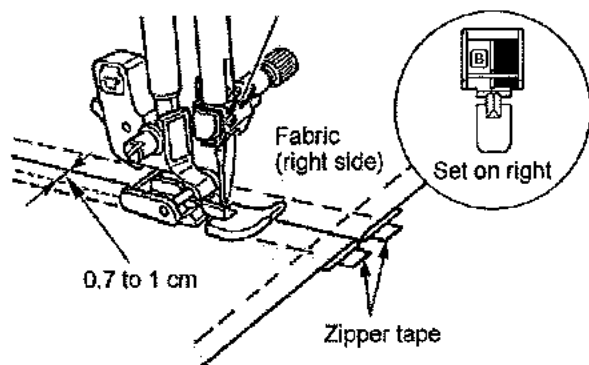

### 2 Sew the left part of the zipper on the seam allowance from the bottom of the opening to the top.

Sew 0.7 to 1 cm from the seam line.

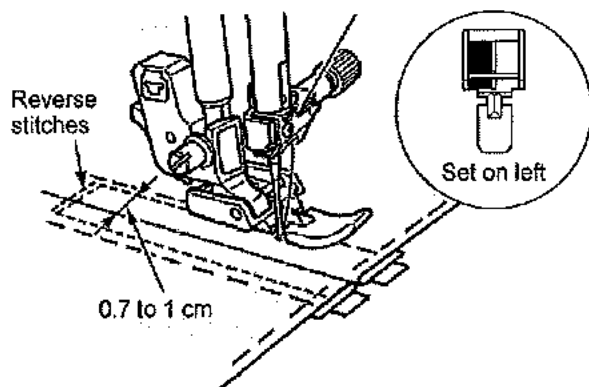

### 3 Sew the right part of the zipper.

Sew reverse stitches a few times. Sew the other side 0.7 to 1 cm from the seam line.

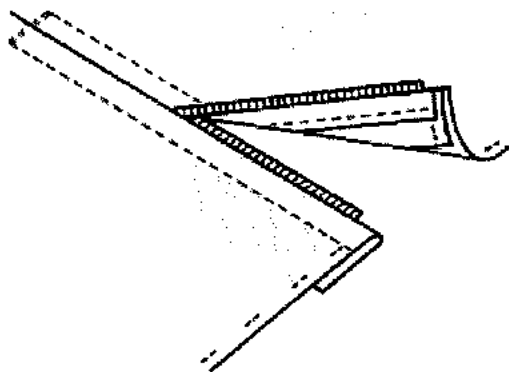

### 4 Undo only the basting stitches.

# Shirring and gathering

|  |   |
|--|---|
|  |   |
|  | <b>Pattern No.</b> Direct 1                   |
|  | <b>Presser foot</b> Standard presser foot (A) |

## ⚠ Attention

Turn off the power before replacing the presser foot.

★ Shirring: such as the shoulder line and waist of the skirt, on which shirring is not seen.

★ Gathering: such as shoulder joining and the frills of a skirt.

### Gathering

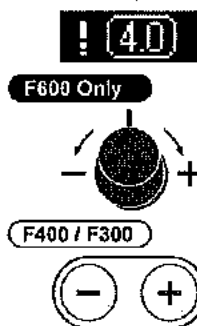

### Shirring

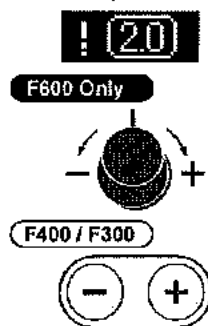

Loose

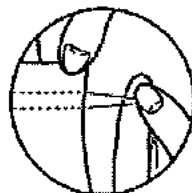
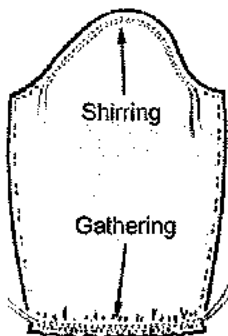
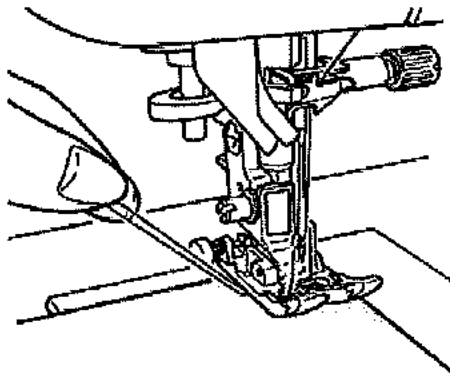

## 1 Change the stitch length.

Set 3.0 - 4.0 for gathering and 1.5 - 2.0 for shirring.

## 2 Loosen the needle thread tension.

## 3 Start sewing.

Leave about 5 cm of needle and bobbin threads both at the sewing start and at the sewing end and sew a parallel line.

## 4 Pull the lower thread by hand to shrink the fabrics

# Pintucking

|  |   |
|--|---|
|  |   |
|  | <b>Pattern No.</b> Direct 1                   |
|  | <b>Presser foot</b> Standard presser foot (A) |

## ⚠ Attention

Turn off the power before replacing the presser foot.

This stitch is used to sew decorations on the front of blouses and/or aprons, etc.

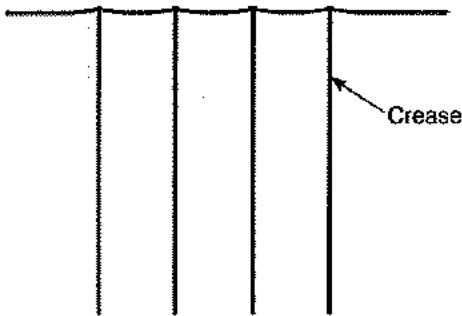

**1** Iron the creases of the pintuck.

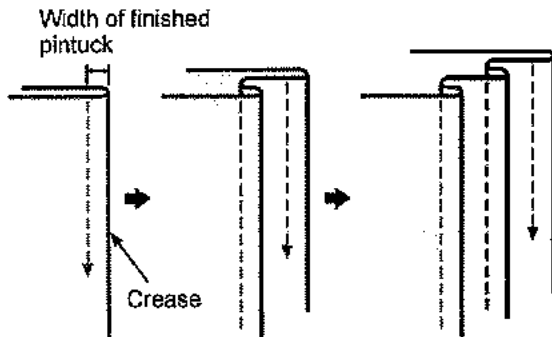

**2** Sew the creases one by one and avoid it stretching.

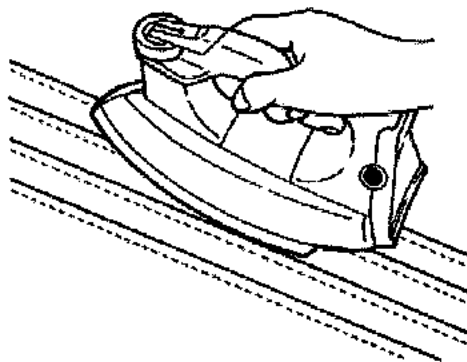

**3** After sewing, turn over pintucks and iron them.

## ■ Example of use

• Blouse



• Apron

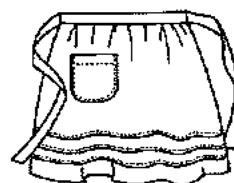

# Welt seam

|  |   |
|--|---|
|  |   |
|  | <b>Pattern No.</b> Direct 1                   |
|  | <b>Presser foot</b> Standard presser foot (A) |

## ⚠ Attention

Turn off the power before replacing the presser foot.

This stitch is used for securing an edge.

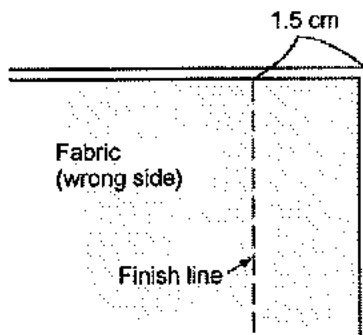

**1** Put the fabrics together and sew.

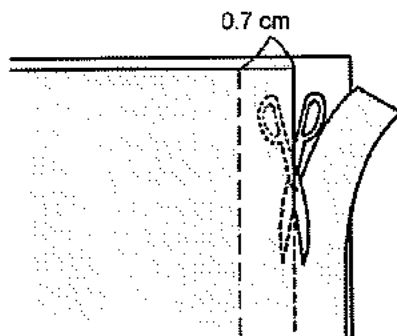

**2** Cut half of the seam allowance.

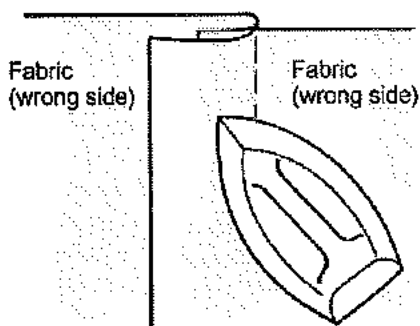

**3** Open the fabrics from the finish line and fold the seam allowance together and iron.

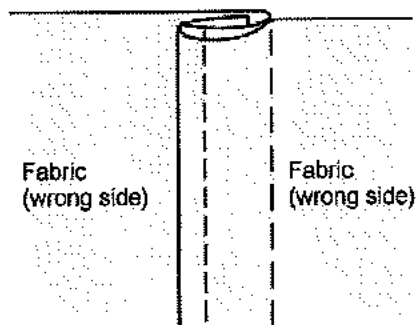

**4** Wrap up the shorter seam allowance with the longer one and sew the edge of the crease.

# How to use the quilt guide

|  |   |
|--|---|
|  |   |
|  | <b>Pattern No.</b> Direct 1, 4                |
|  | <b>Presser foot</b> Standard presser foot (A) |

## ⚠ Attention

Turn off the power before replacing the presser foot.

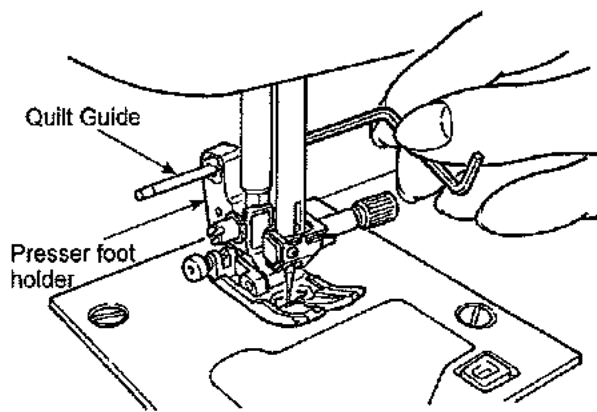

**1** Insert the quilt guide into the groove of the presser foot holder.

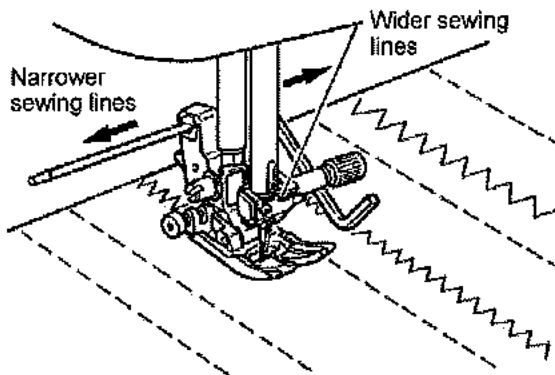

**2** Sew while tracing the stitches with the tip of the quilt guide.

Distance between sewing lines can be adjusted freely.

## Scallop stitches

|                     |  |
|---------------------|--|
|                     |  |
|                     | <b>Pattern No.</b><br>One point 24, 25 <b>F600</b><br>One point 24 <b>F400</b><br>One point 13 <b>F300</b> |
| <b>Presser foot</b> | Manual buttonhole presser foot (I)   |

### Attention

Turn off the power before replacing the presser foot.

This stitch is used for decorating edging on items such as table cloths, collars on blouse, etc.

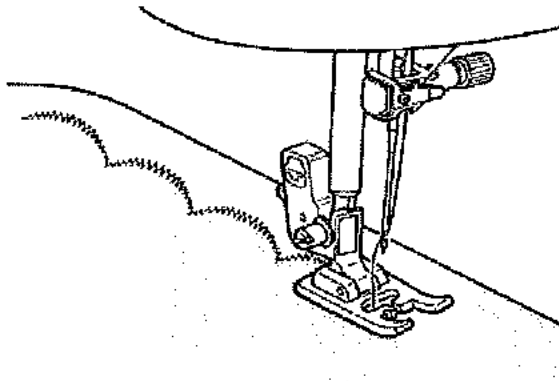

- 1** To keep the pattern intact, leave some margin and sew on the edge of the cloth.

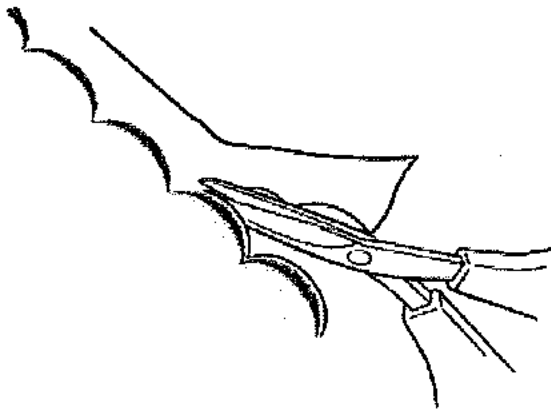

- 2** Cut the sewn fabric carefully so that stitches are not cut by the scissors.

\* Adjust stitch length of the decorative stitches according to the fabric to be sewn.  
Sewing on fabric too thick may cause jamming.

# Decorative stitches

|  |  |
|--|--|
|  |  |
|  | <b>Pattern No.</b><br>Decorative 01~72 <b>F600</b><br>Decorative 01~49 <b>F400</b><br>Decorative 01~20 <b>F300</b> |
|  | <b>Presser foot</b><br>Manual buttonhole presser foot (I)  |

## Attention

Turn off the power before replacing the presser foot.

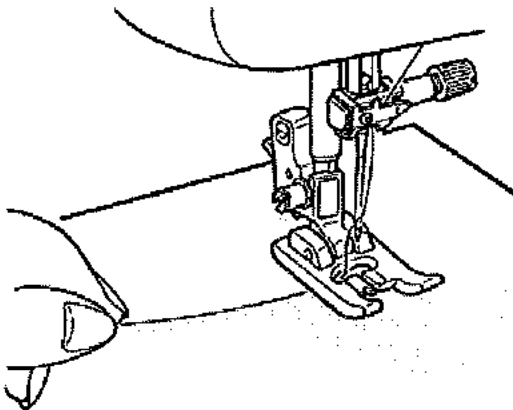

Place the fabric under the presser foot and start.

## Display of the length of one cycle

Although the length of one cycle of the decorative pattern is displayed, treat it only as a reference, as this will be changeable based on fabric and thread.

Example) 's

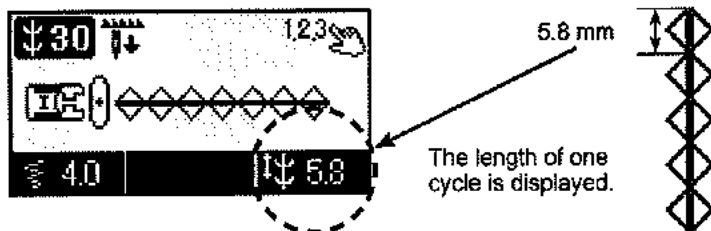

# Patchwork piecing

|  |   |
|--|---|
|  |   |
|  | <b>Pattern No.</b> Direct 2                   |
|  | <b>Presser foot</b> Standard presser foot (A) |
|  |   |

## ⚠ Attention

Turn off the power before replacing the presser foot.

To sew pieces of cloth together is called piecing in patchwork. When piecing, the seam allowance is usually 7mm.

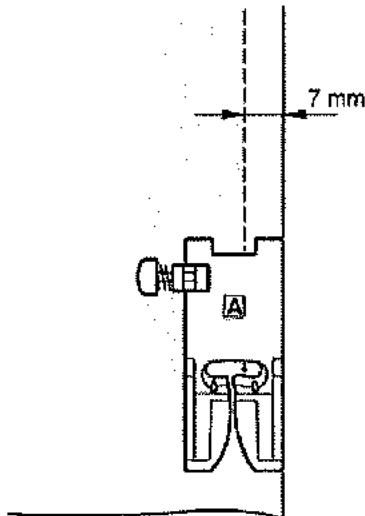

**1** Cut the fabric with seam allowance.

**2** Align the right end of the presser foot and the edge of the fabric and sew.

The needle will enter 7mm from the edge of the fabric, so the seam allowance of 7mm can be sewn.

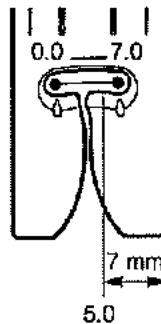

The needle position can be adjusted between 0.0~7.0.

When the needle position is at '5.0', the needle is 7mm from the right edge of standard presser foot (A).

\* You can change the needle position as you like.  
Needle position change: Refer to page 81



# Applique (1)

|  |   |
|--|---|
|  |   |
|  | <b>Pattern No.</b> Direct 5   |
|  | <b>Presser foot</b><br>Manual buttonhole presser foot (I)<br>Open toe presser foot (O) <b>F600 Only</b> |

## ⚠ Attention

Turn off the power before replacing the presser foot.

The edge of the applique fabric is sewn with a compact zigzag, so it is suitable for the applique of cut fabric.

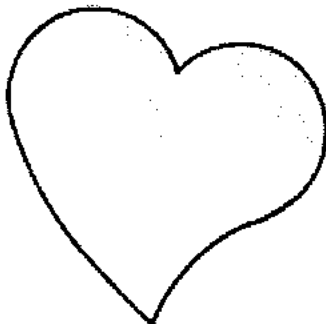

- 1** Cut the applique fabric at the finish line, put it on the base fabric and fix it temporarily.

It is recommended to use both-sided adhesive interlining or the similar to fix the appliqué fabric on the base fabric. Use the interlining to the edge of the appliqué fabric.

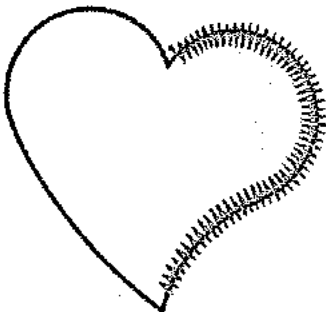

- 2** Turn the hand wheel towards you and start sewing along with the outer side of the applique fabric.

When you start sewing, the machine will automatically sew 3 lock stitches.

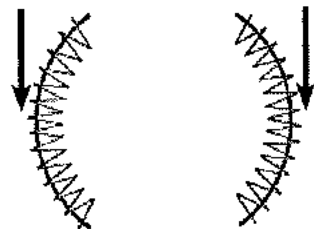

Keep the needle inside the fabric at the point of arrow and raise the presser foot.

\* When sewing steep angles, keep the needle inside the fabric, raise the presser foot, change sewing direction and sew slowly.

- 3** At the end of sewing, push the reverse stitch button to sew lock stitches for 3~5 stitches.

\* Usually center needle position is used for appliqué stitches but right or left needle position can be used. Changing needle position: Refer to page 81

## Applique (2)

|  |   |
|--|---|
|  |   |
|  | <b>Pattern No.</b> Direct 6<br>Quilting 01~04, 35~37 <b>F600</b><br>Quilting 01~04, 07, 08 <b>F400/F300</b> |
|  | <b>Presser foot</b> Manual buttonhole presser foot (I)<br>Open toe presser foot (O) <b>F600 Only</b>        |

### Attention

Turn off the power before replacing the presser foot.

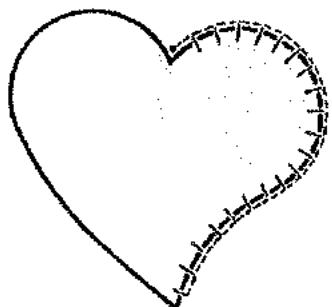
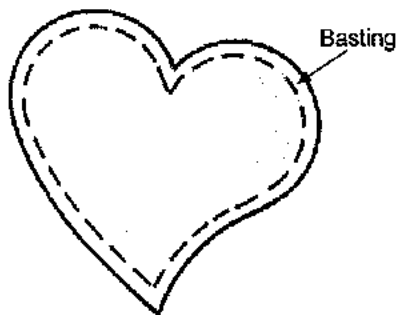
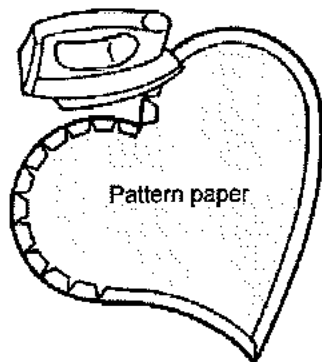
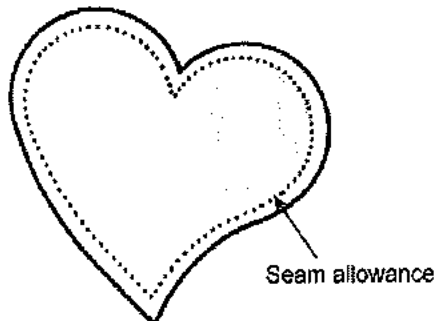

To make the stitch inconspicuous, an applique can be sewn.

- 1** Cut the applique fabric with seam allowance of 3~5mm.
- 2** Put the pattern paper onto the wrong side of the fabric and fold the seam allowance at the finish line.
- 3** Put the applique fabric on the base fabric. Temporarily fix it with basting stitches or glue.
- 4** Turn the hand wheel towards you and start sewing along with the outer side of the applique fabric.
 

When you start sewing, the machine will automatically sew 3 lock stitches.

\* When sewing steep angles, keep the needle inside the fabric, raise the presser foot, change sewing direction and sew slowly.
- 5** Lock stitch at the end of sewing.
 

Push the reverse stitch button and the machine will automatically sew 3 lock stitches.

It is better to lock stitch at the outer side of the applique fabric.

\* Usually center needle position is used for appliqué stitches but right or left needle position can be used.  
 Changing needle position: Refer to page 81

# Crazy quilt

|  |                     |   |  |                       |
|--|---------------------|---|--|-----------------------|
|  |                     |   |  | <b>Pattern number</b> |
|  | <b>Pattern No.</b>  | <b>Quilting 01~67</b> <b>F600</b><br><b>Quilting 01~29</b> <b>F400</b><br><b>Quilting 01~22</b> <b>F300</b> |  |                       |
|  | <b>Presser foot</b> | <b>Manual buttonhole presser foot (I)</b>   |  |                       |

## ⚠ Attention

Turn off the power before replacing the presser foot.

Using a decorative stitch, this gives a decorative look to the joining of patchworks. It is recommended to use decorative thread such as embroidery thread.

### Example 1) Quilting 08

Sew patterns so that they extend over both pieces of fabric.

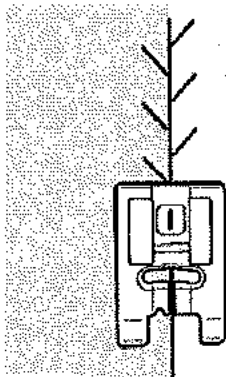

### Example 2) Quilting 10

Sew patterns so that the presser foot holds one side of fabric.

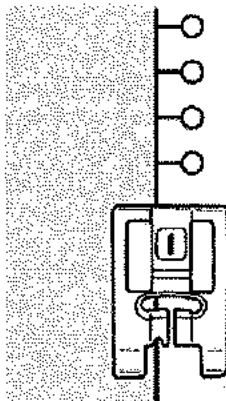

**F600 Only**

### ★ Random pattern

Random slitch patterns (Quilting 18~34) are transformations of Quilting 01~17.

The width can be changed automatically by section, so that you can enjoy those patterns.

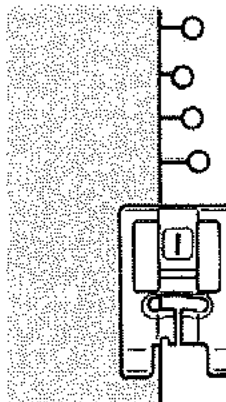

## Stitch in ditch quilting

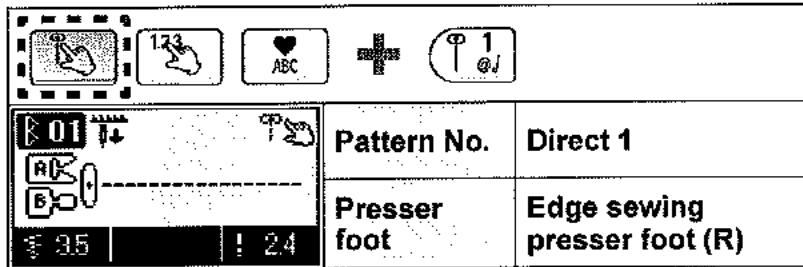

### ⚠ Attention

Turn off the power before replacing the presser foot.

This is for quilting the edge of patchworks and appliqués. The machine will sew the lower (thinner) side of the fabric layers. As a result, the stitches will not be noticeable and have an effect to make the design look three dimensional or emphasized.

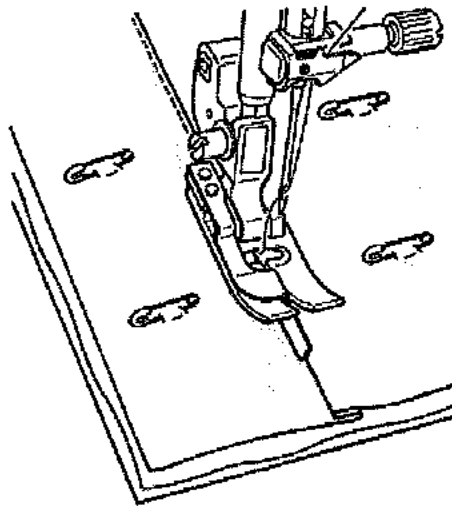

**1** Put the top layer of fabric with patchwork and/or appliqués, quilting cotton and bottom layer of fabric together by pin or basting stitches.

**2** Put the guide of the presser foot along with the crease and sew.

The needle enters behind the guide, so that the edge of the crease can be sewn.

\* If the desired points can not be sewn, adjust the needle position.

Needle position change: refer to page 81

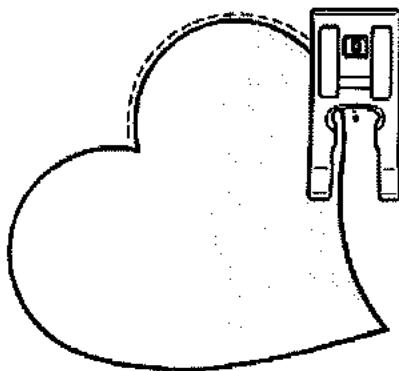

### ★ Curved concealed quilting

Use manual buttonhole presser foot (I) or the open toe presser foot (O). Sew curves by lifting the presser foot and changing the direction very often.

Also this can be done by free motion with the quilt presser foot. (Refer to page 69.)

# Quilting (straight stitch)

|  |                                      |
|--|--------------------------------------|
|  |                                      |
|  | <b>Pattern No.</b> Direct 1, 4       |
|  | <b>Presser foot</b> Walking foot (N) |

## Attention

Turn off the power before replacing the presser foot.

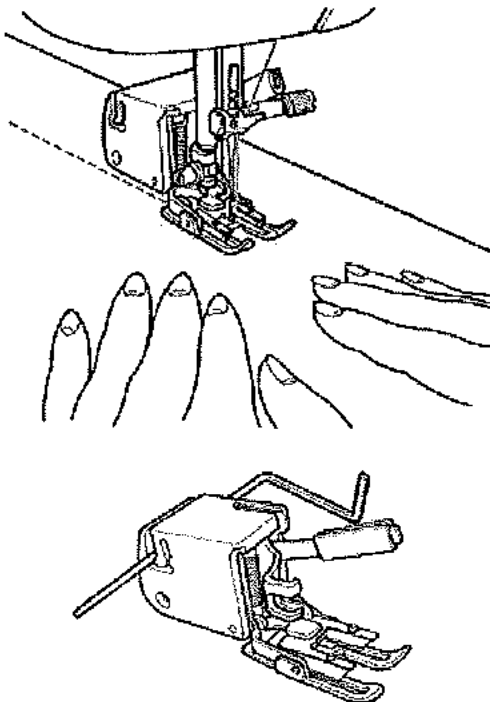
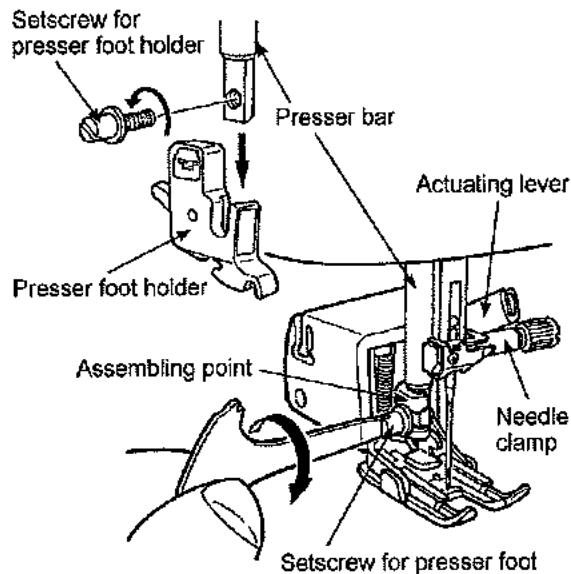

Quilting is the process of sewing the top layer of fabric, with quilting cotton in between and a bottom layer of fabric underneath.

By using the walking foot, the machine feeds both top and bottom fabrics together at the same time, so fabric shifting is eliminated.

**1** Put top layer of fabric with patchwork and/or appliqué, quilting cotton and bottom fabric together by using pin or basting stitches.

**2** Assemble the walking foot.

Raise the presser bar. Loosen the setscrew for presser foot holder and remove the presser foot holder. (Refer to page 13)

Set the actuating lever on the needle clamp and insert the assembling point to the presser bar and tighten the setscrew for presser foot.

**3** Place your hands to both sides of the presser foot and sew by pulling the fabrics apart.

\* Sew with slow to medium sewing speed.

\* To further avoid fabric shifts, set the presser foot pressure lower.

Adjustment of presser foot pressure: Refer to page 26

\* If it is necessary to sew with the same distance, use quilt guide.

Quilt guide: Refer to page 60

## Quilting (free motion)

|                     |                               |
|---------------------|-------------------------------|
|                     |                               |
|                     | <b>Pattern No.</b> Direct 1   |
| <b>Presser foot</b> | <b>Quilt presser foot (Q)</b> |

### ⚠ Attention

Turn off the power before replacing the presser foot.

It is called free motion quilting when moving the fabrics freely towards any directions without using the feed dog of sewing machine.

When the feed dog is lowered (drop feed condition), it is possible to sew various curves and/or any directions by moving the fabrics by hands.

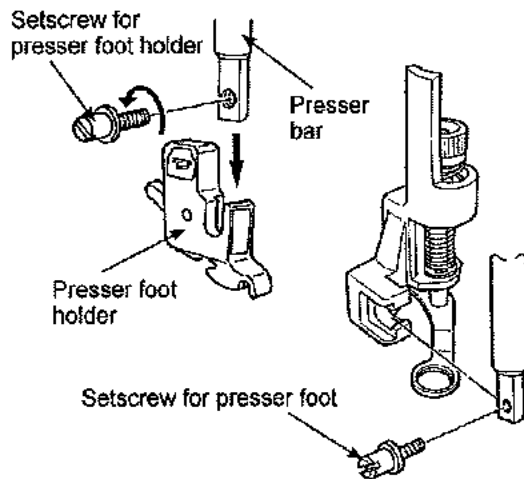

**1** Put top layer of fabric with patchwork and/or appliqué, quilting cotton and bottom fabric together by using pin or basting stitches.

**2** Assemble the quilt presser foot.

Raise the presser bar. Loosen the setscrew for presser foot holder and remove the presser foot holder. (Refer to page 13)

Set the quilting foot and tighten the setscrew for presser foot.

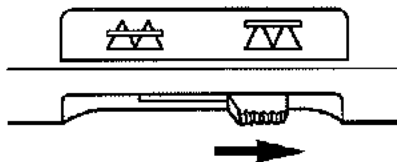

**3** Move the drop feed knob to the right hand side.

Feed dog is now down.

**4** Place the fabric underneath the presser foot and lower the presser foot.

**5** Adjust the height of presser foot according to the thickness of the fabrics by screw. When the height is 1mm from the surface of the fabrics, it will be easier to move the fabrics without interference.

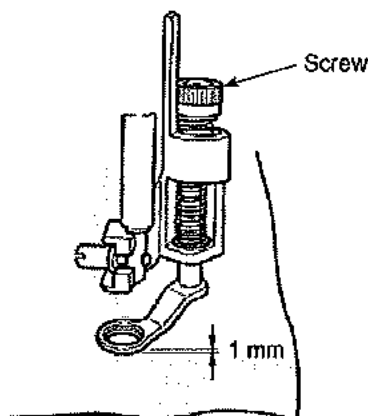

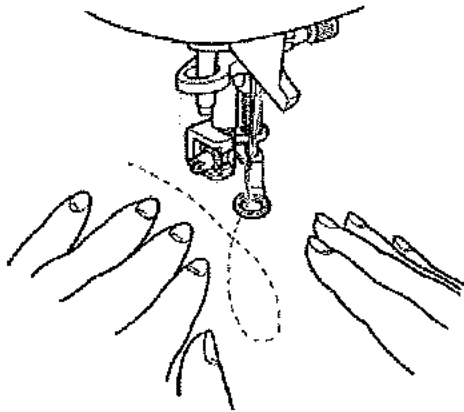

**6** Use both hands to hold the fabrics and move it without letting it loose. The target stitch length is about 1.5~2.0mm.

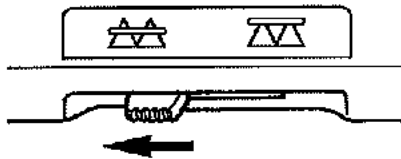

**7** When free motion sewing is finished, move the drop feed knob back to the left side.

The feed dog will be up and engaged at the same time as the machine starts to sew.

### Tips

#### • How to lock stitches

1. At sewing start, pull up the bobbin thread on the top layer of the fabric, hold both needle and bobbin threads together and sew 3 stitches on the same point. After that move fabrics as you wish. In this way, stitches on the wrong side of the fabrics look neat.
2. At sewing-end sew 3 stitches on the same point and stop.

#### • How to sew stitches with the same stitch length

1. When the foot controller is used, the fabrics can be guided by both hands and you can move the fabrics freely.
2. Set the speed controller to medium or medium low first, press the foot controller completely and move the fabrics.
  - if stitches become too large, set the speed controller to "faster"
  - if stitches become too small, set the speed controller to "slower".

☆ When doing the free motion with zigzag stitch, use the quilt presser foot (transparent type) which is optionally available from your dealer.

# One-point stitch/sewing letters

|                            |  |                     |  |
|----------------------------|--|---------------------|--|
|                            |  |                     | +  |
| <b>F600</b>                |  | <b>Pattern No.</b>  | One point 01~38 <b>F600</b><br>One point 01~33 <b>F400</b><br>One point 01~18 <b>F300</b><br>Letters |
| <b>F400</b><br><b>F300</b> |  | <b>Presser foot</b> | Manual buttonhole presser foot (I)   |

**Attention**

Turn off the power before replacing the presser foot.

## Preparation before sewing

(in order to sew a pattern neatly, apply interlining and conduct a test sewing first.)

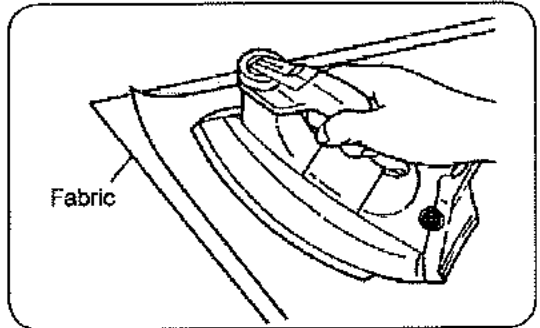

Use an iron to attach a fusible interlining to the wrong side of fabric.

\* When stitch length becomes too small, the bobbin thread will come out to the front side of fabric and/or stitches might get stuck. Therefore make sure to conduct a test sewing beforehand.

## Test sewing

|            |            |            |            |                     |   |  |
|------------|------------|------------|------------|---------------------|---|--|
|            |            |            | +          |                     | +   |  |
| <b>22</b>  |            |            | <b>22</b>  | <b>Pattern No.</b>  | Practical 22 <b>F600</b><br>Practical 20 <b>F400 / F300</b> |  |
| <b>7.0</b> | <b>2.1</b> | <b>2.1</b> | <b>2.1</b> | <b>Presser foot</b> | Manual buttonhole presser foot (I)                          |  |

Since the pattern might be deformed according to the type and thickness of fabric and fusible interlining to be used, make sure to conduct test sewing on the same fabric and interlining.

Select stitch pattern No. 22 **F600** (No. 20 **F400 / F300**) for test sewing; if the stitch pattern deforms, adjust it by the pattern adjustment dial.

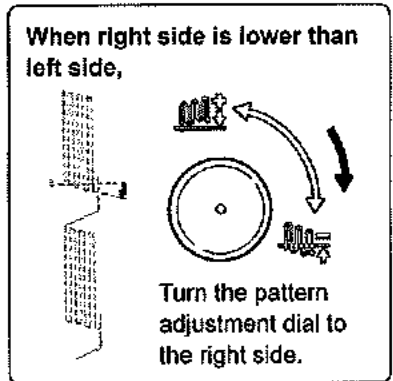
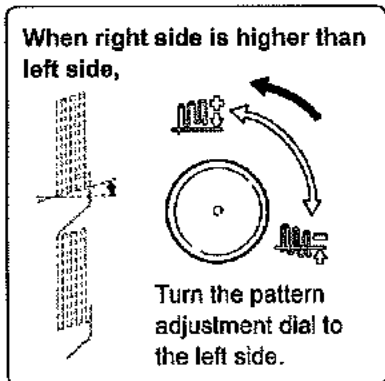
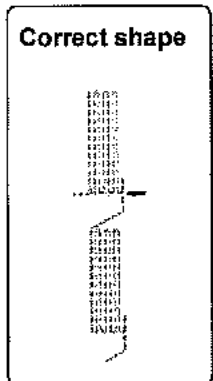
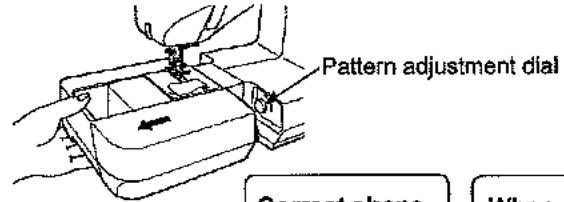



## Operational buttons and screen

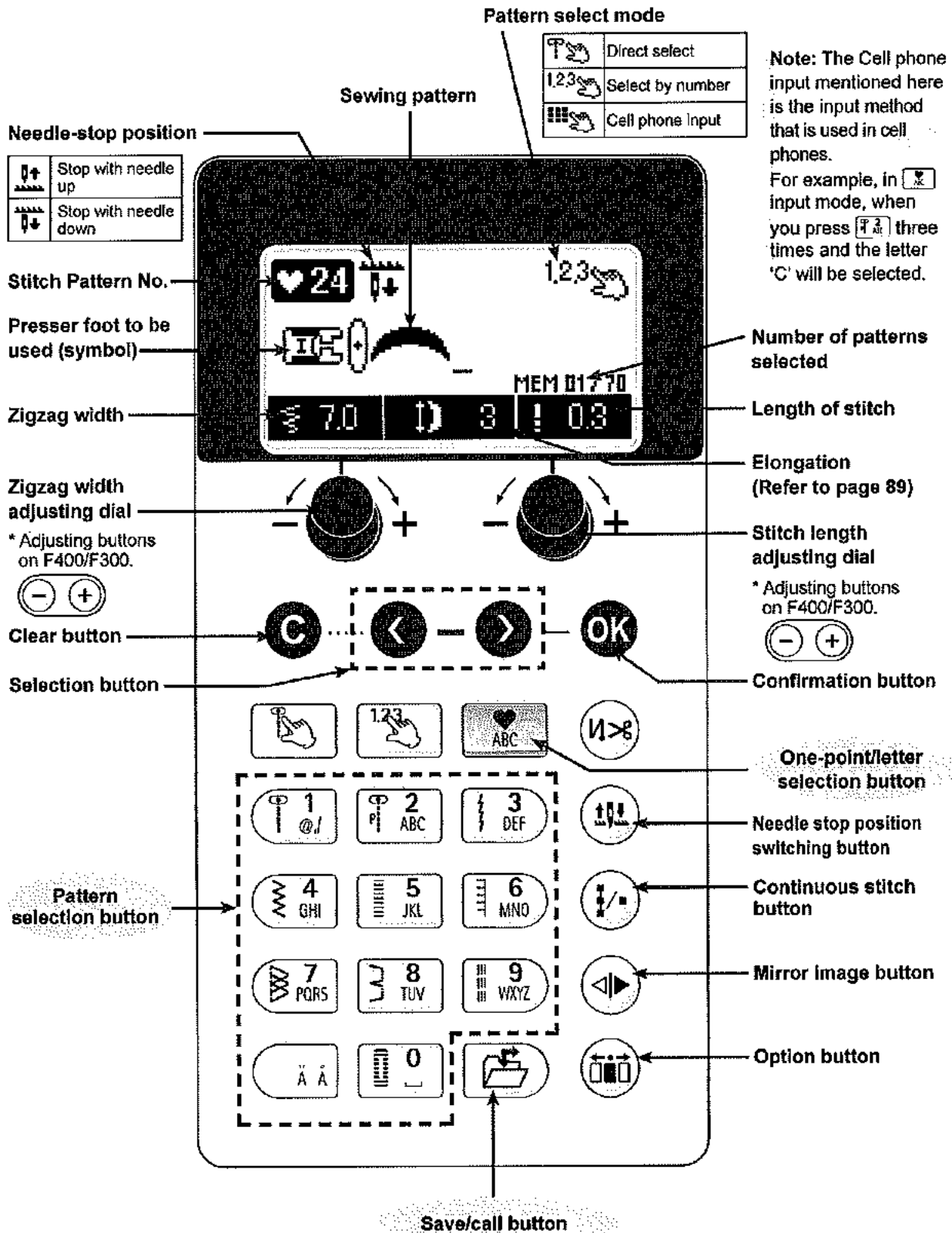

## ■ How to select pattern (letters)

Press

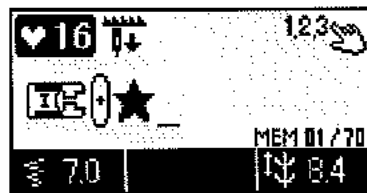
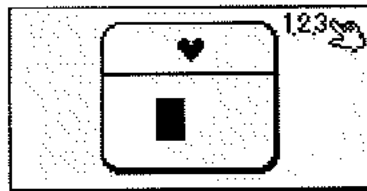

Press **OK**

Press **1** and **6**

(Pattern No. 16)

Press **ABC**

Press **➤**

Select **Aa**

Example:

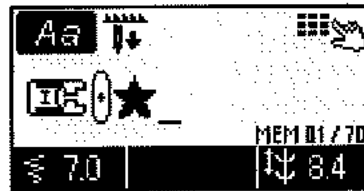

Press **OK**

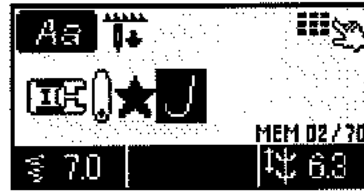

Press **5** one time.

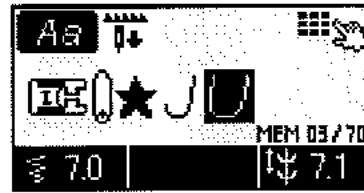

Press **3** twice.



Press **5** twice.



Press **4** three times.

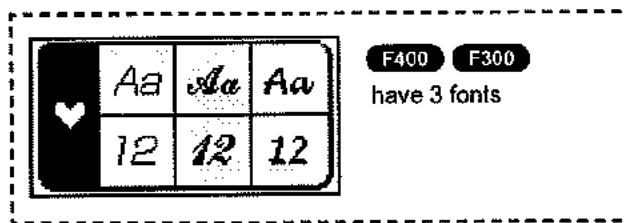

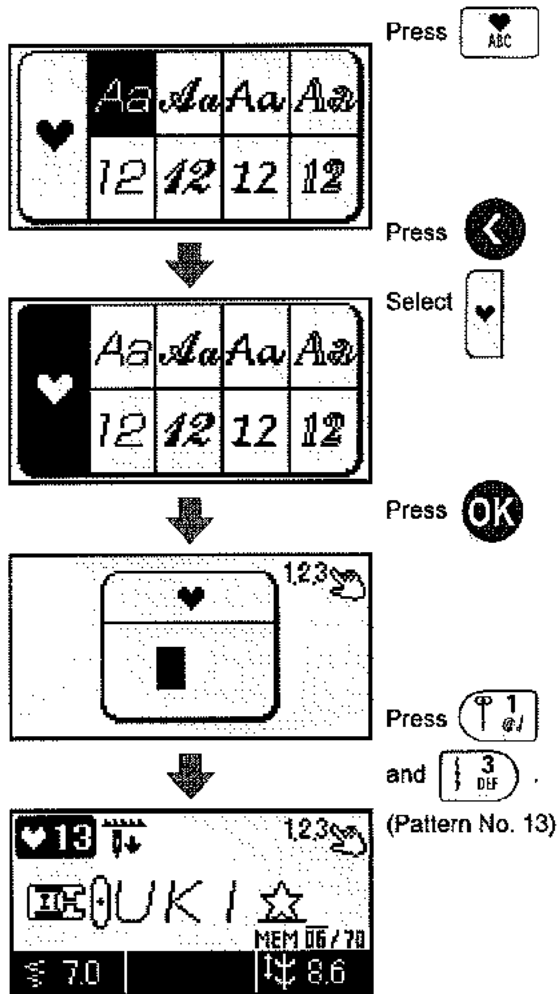

**When you want to change the size of pattern (letters) .....**

Move the cursor to the desired pattern (letter).  
You can change the height and width by:

Height: Zigzag width adjusting dial  
Width: Stitch length adjusting dial





## ■ How to edit patterns (letters)

### Example)



Change ★ to ☆.



Press , and move the  (cursor) to the position where you wish to delete.



By pressing , the pattern on the cursor "★" will be deleted.



Press .

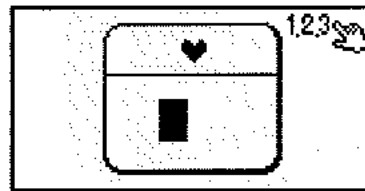
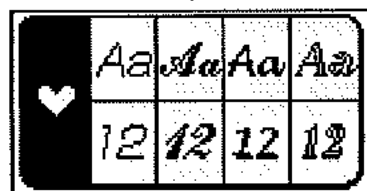

Press .

Press .

and .

(Pattern No. 13)

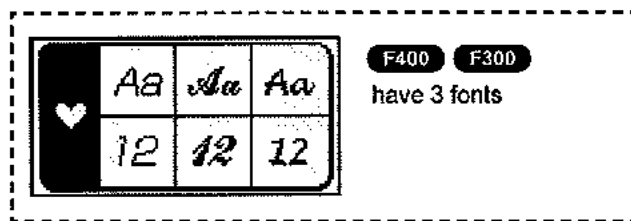

---

---

## ■ How to stitch a pattern (letters)

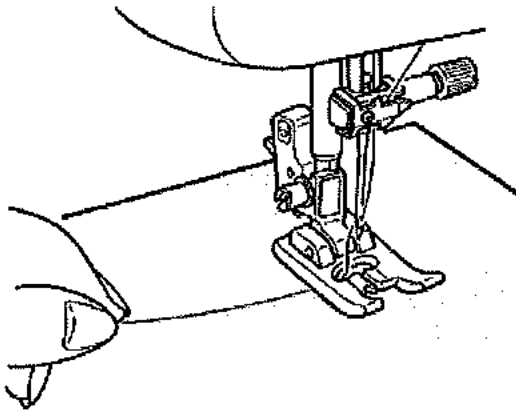

**Place the fabric underneath the presser foot and start.**

The machine will stop automatically when sewing is finished.

### Notes:

1. Note that the sewing speed varies according to stitch patterns (letters) to be sewn.
2. If the automatic thread trimmer is used while sewing, the machine starts to sew from the beginning.
3. In case of condensed sewing, if the stitch length is too small, the stitches may get stuck.

## ■ Disposing thread ends of jump stitches

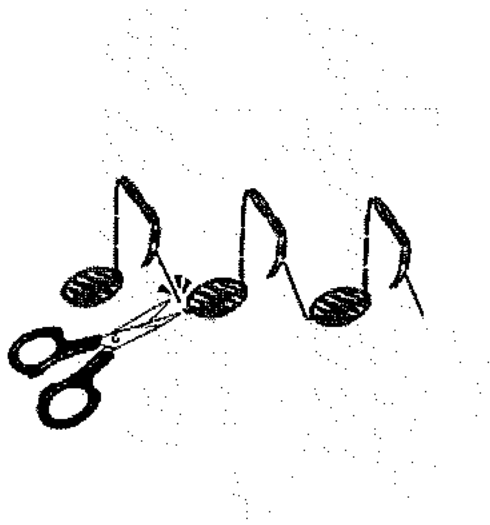

**Get rid of unnecessary thread on the front side of fabric by scissors.**



## ■ Save/call of patterns (letters)

The letters and one point patterns can be combined and saved for later use.  
There are 10 folders in total for saving.

### (Save)



Press

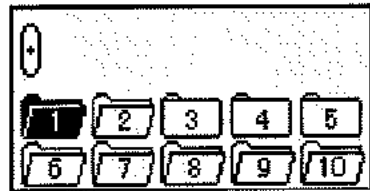

Use to select folder to save and press

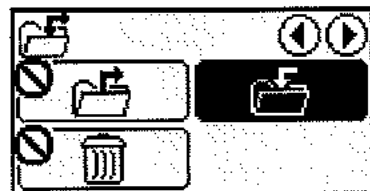

Notes: means there exists already a pattern.  
 means empty and available for saving pattern.

Press



### (Call)



Press

Press to select the folder where you wish to call the desired combination.



Press

Press

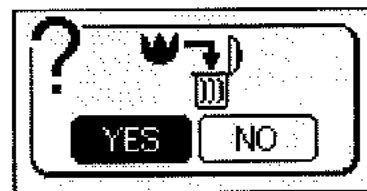

Press



★ To delete the content stored inside a folder.

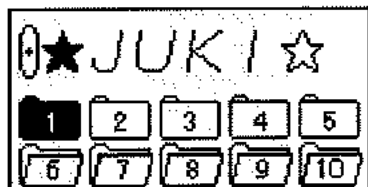

Press 

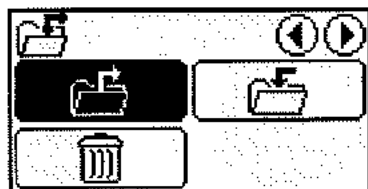

Use  to select the target folder where content to be deleted is stored.

Press 

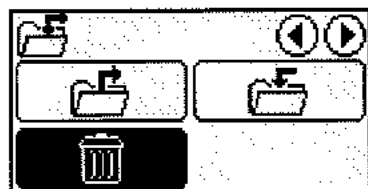

Use  to select "delete" and

press 

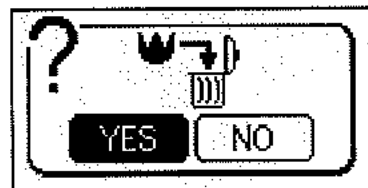

Press 

# Character selecting methods

Aa Aa Aa Aa

|  | No. of pressing a button |   |   |   |   |   |   |   |   |    |    |    |    |    |
|--|--------------------------|---|---|---|---|---|---|---|---|----|----|----|----|----|
|  | 1                        | 2 | 3 | 4 | 5 | 6 | 7 | 8 | 9 | 10 | 11 | 12 | 13 | 14 |
|  | @                        | ! | & | ' | ( | ) | . | . | ? | -  | .  | /  | :  | ;  |
|  | A                        | B | C | a | b | c |   |   |   |    |    |    |    |    |
|  | D                        | E | F | d | e | f |   |   |   |    |    |    |    |    |
|  | G                        | H | I | g | h | i |   |   |   |    |    |    |    |    |
|  | J                        | K | L | j | k | l |   |   |   |    |    |    |    |    |
|  | M                        | N | O | m | n | o |   |   |   |    |    |    |    |    |
|  | P                        | Q | R | S | p | q | r | s |   |    |    |    |    |    |
|  | T                        | U | V | t | u | v |   |   |   |    |    |    |    |    |
|  | W                        | X | Y | Z | w | x | y | z |   |    |    |    |    |    |
|  | -                        |   |   |   |   |   |   |   |   |    |    |    |    |    |

12 12 12 12

|  | No. of pressing a button |
|--|--------------------------|
|  | 1                        |
|  | 1                        |
|  | 2                        |
|  | 3                        |
|  | 4                        |
|  | 5                        |
|  | 6                        |
|  | 7                        |
|  | 8                        |
|  | 9                        |
|  | 0                        |

|                              |                               | No. of pressing a button |   |   |   |   |
|------------------------------|-------------------------------|--------------------------|---|---|---|---|
|                              |                               | 1                        | 2 | 3 | 4 | 5 |
|                              | Immediately after selecting A | À                        | Á | Æ | Ä |   |
|                              | Immediately after selecting a | à                        | á | æ | ä |   |
|                              | Immediately after selecting C | Ç                        | Ç |   |   |   |
|                              | Immediately after selecting c | ç                        | ç |   |   |   |
|                              | Immediately after selecting e | è                        | é | ê | ë | e |
|                              | Immediately after selecting i | ì                        | í |   |   |   |
|                              | Immediately after selecting N | Ñ                        | Ñ |   |   |   |
|                              | Immediately after selecting n | ñ                        | n |   |   |   |
|                              | Immediately after selecting O | Ö                        | Ø | Ó |   |   |
|                              | Immediately after selecting o | ò                        | ó | ø | œ | o |
|                              | Immediately after selecting U | Ü                        | U |   |   |   |
|                              | Immediately after selecting u | ü                        | ü | u |   |   |
| Other than the above letters | Ineffective                   |                          |   |   |   |   |



# Type and usage of options

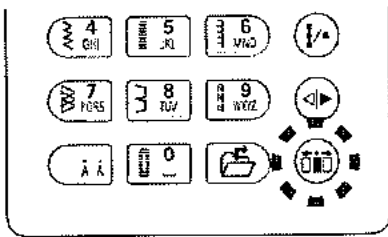

## < Type of options >

|  |  |
|--|--|
|  | Changing the seam width of buttonhole    |
|  | Change of needle position                |
|  | Setting thread trimming foot switch      |
|  | Twin needle sewing                       |
|  | Guide                                    |
|  | Contrast of Liquid Crystal Display (LCD) |
|  | Button reception buzzer volume setting   |
|  | Language setting                         |
|  | Elongation                               |

## ① Change of seam width of buttonhole

The seam width of buttonhole is changeable.  
\* It is changeable when sewing a buttonhole.

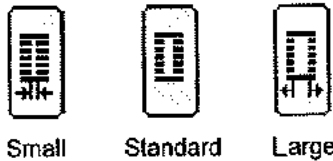

\* Default setting is "standard".

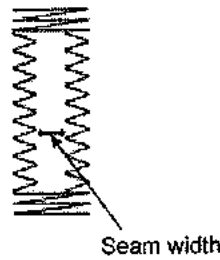

### Example) narrowing (reducing) the seam width

The width is now changed.

\* When opening buttonhole with a ripper, make sure not to cut the stitches.

\* The setting goes back to the default setting after the sewing machine is turned off and on.

## ② Change of needle position

Example) change the needle position of zigzag stitch to left needle position.

\* Default setting is center needle position.

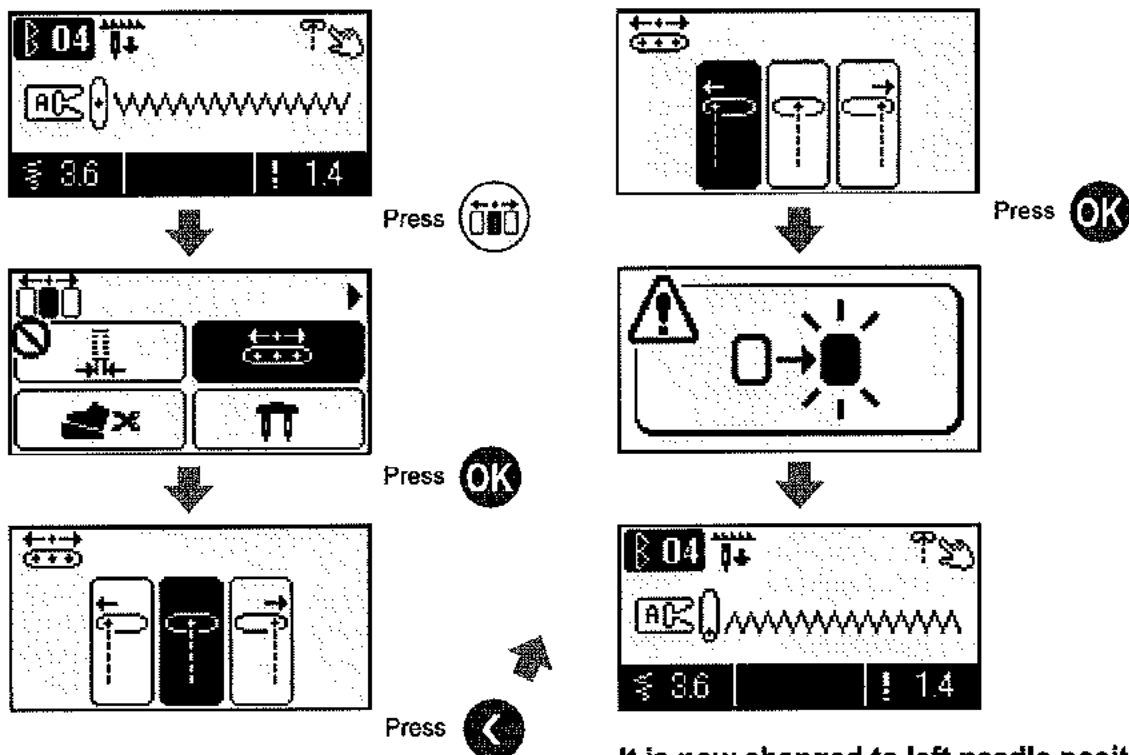

It is now changed to left needle position.

\* In case of a combined stitch pattern, if the needle position is changed, the needle position of the selected patterns is all changed to the same needle position at the same time. However, if letter is included in the combined stitch pattern, needle position will not be changed.

\* After a change of needle position and in the event that other stitch pattern is selected, the sewing machine goes back to the default setting.

### ③ Setting the thread trimming foot switch to OFF

In order to avoid trimming the thread by mistake while sewing, you can set the thread trimming foot switch to "off" beforehand.

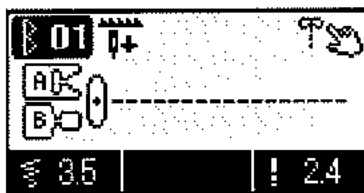

Press

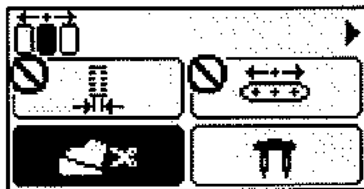

Press



Press

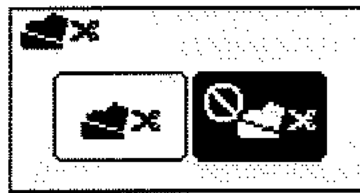

Press

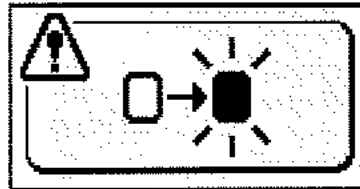

The thread trimming foot switch is now turned off.

\* There is not a change in the display, however, even if the foot switch is pressed, threads will not be trimmed.

\* The setting is memorized even when the machine is turned off and on.

## ④ Twin needle sewing

By using two needles beautiful decorative stitches can be sewn.

\* When using twin needles, make sure to set twin needle sewing in Option  and perform test sewing.

\* When twin needle sewing, make sure to use thread size smaller than No. 60.

\* Make sure to use a twin needle with size of 2.0 mm (included needle: 2.0 mm).

\* When twin needle sewing, the sewing speed will become slower.

|  |   |
|--|---|
|  <b>Attention</b> | Turn off the power before replacing needles.                    |
| <b>Pattern No.</b>   | <b>Direct 1, 4</b>  |
|  | <b>F600</b> One-point 17, 19, 20, 21, 24~31, 34~38              |
|  | <b>F400</b> One-point 17, 19, 20, 21, 24~29, 31~33              |
|  | <b>F300</b> One-point 9, 10, 13~17                              |
| <b>Presser foot</b>  | Standard presser foot (A)<br>Manual buttonhole presser foot (I) |

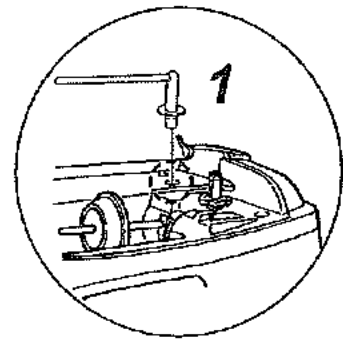
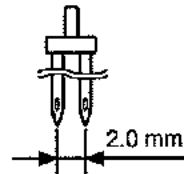

\* Bobbin winding is also possible with supplementary spool pin.

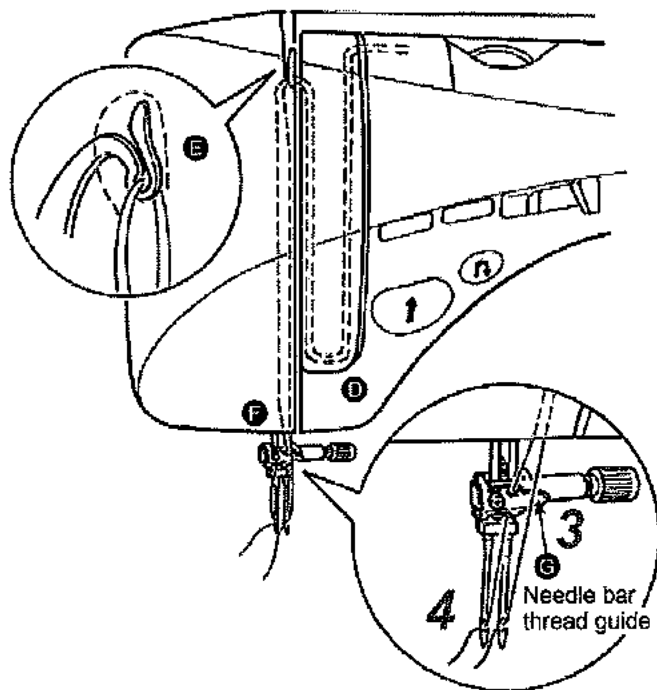
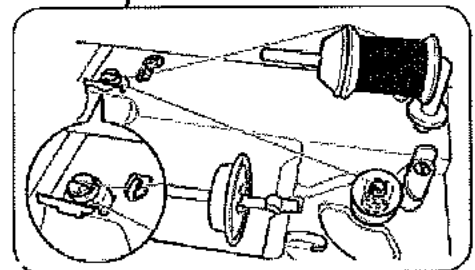
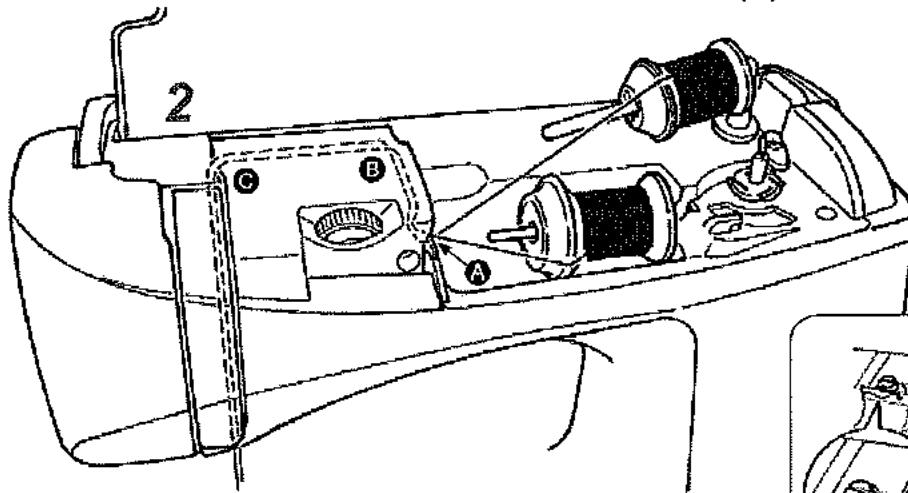

### ■ How to thread the needles

- 1 Place the supplementary spool pin.
- 2 Thread to the thread guide **A** first. After that, thread paths are same up from **B** to **F**.
- 3 Do not thread **E** for right-hand needle.
- 4 Thread to right-hand and left-hand needles separately.

\* Automatic needle threader can not be used. Thread each needle manually.  
\* Automatic thread trimmer can not be used in case of twin needle sewing.

## ■ Setting of twin needle sewing

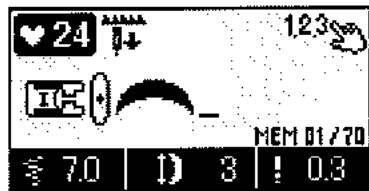

\* Select a stitch pattern suitable for twin needle sewing.

Press

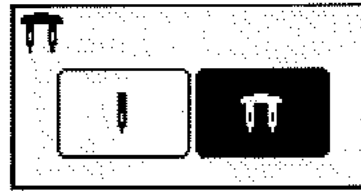

Press

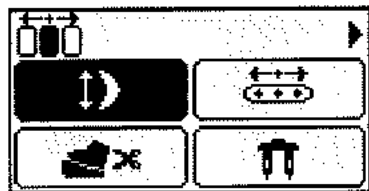

Press three times.

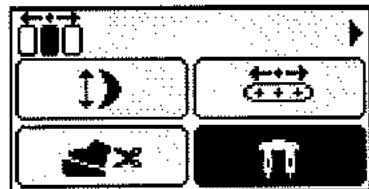
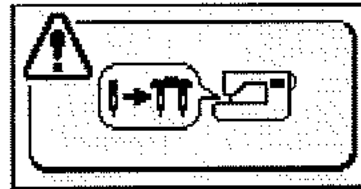

Press

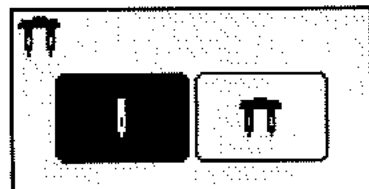
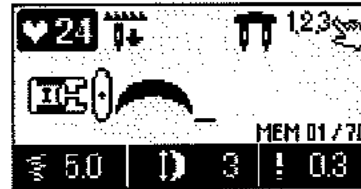

Press

Symbol of twin needle sewing will be shown on the display.

- \* When in twin needle sewing, the stitch patterns will be limited. In addition, the stitch length and zigzag width will be also adjusted to suit the twin needle sewing.
- \* The setting is memorized even when the machine is turned off and on.

\* Twin needle setting can not be done while a stitch pattern other than those for twin needle sewing is selected.



mark will be shown.



The twin needle setting can only be carried out when suitable pattern is selected and center needle position is selected at the same time.

\* Maximum zigzag width is 7.0 mm, however, display shows .



The sewing image



Maximum 7.0 mm

## ⑤ Guide

The guide for winding bobbin thread, setting of bobbin, threading of needle thread, changing presser foot and needle can be seen on the LCD display.

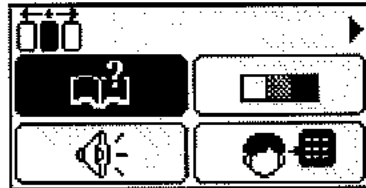
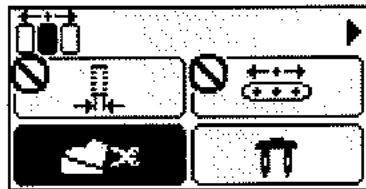
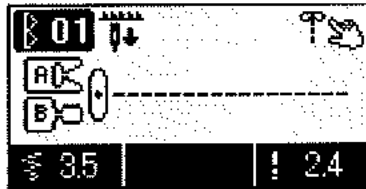

Press

Press twice.

Press

The page will proceed when pressing

### <Winding bobbin thread>

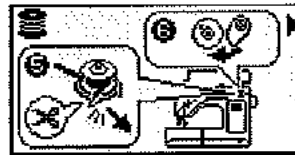
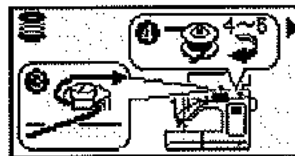
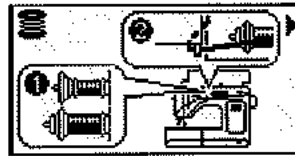

### <Setting of bobbin>

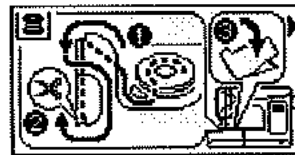

### <Changing presser foot>

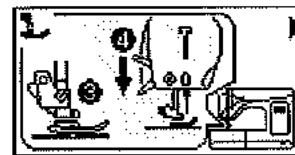
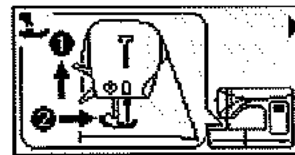

### <Threading of needle thread>

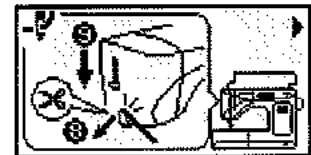
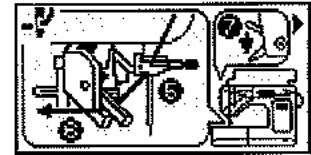
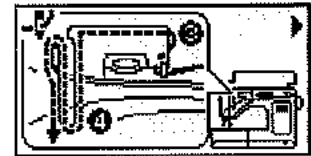
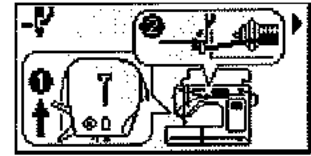

### <changing needle>

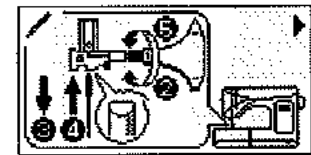
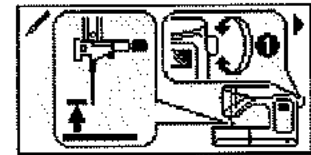

Press or to end the guide.

## ⑥ Contrast of Liquid Crystal Display (LCD)

The LCD contrast can be chosen from 11 levels.

Example) Reduce the contrast of display.

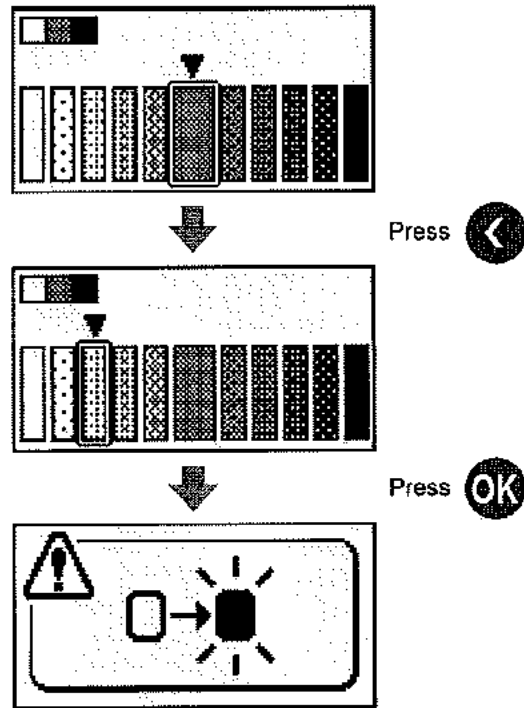
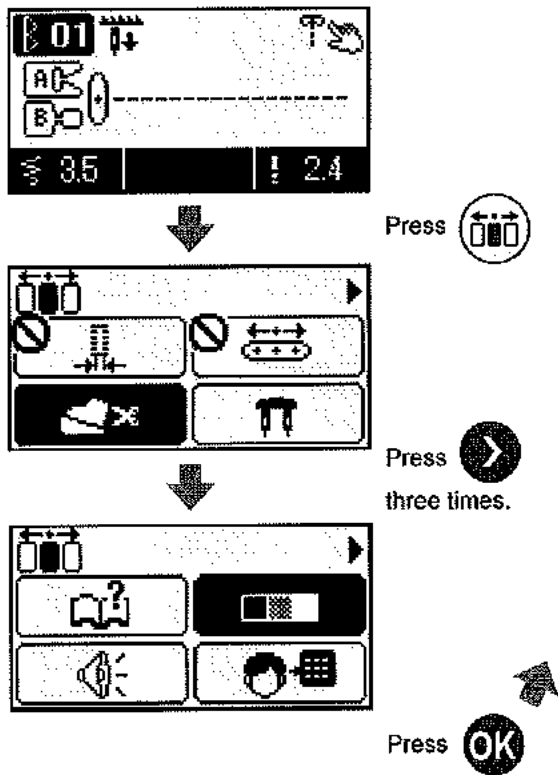

The contrast is now changed.

\* The setting is memorized even when the machine is turned off and on.

## ⑦ Button reception buzzer volume settings

The volume of buzzer can be adjusted.

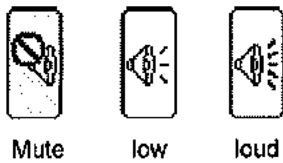

Example) Setting the volume to “mute”

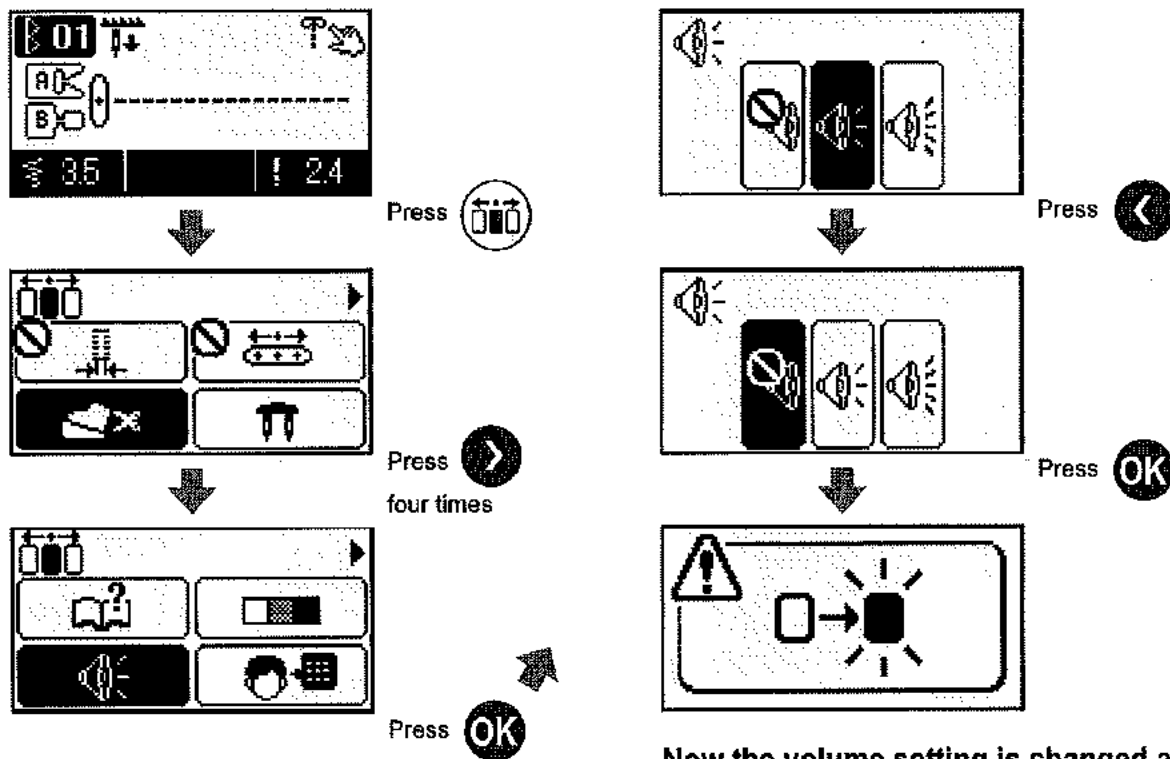

Now the volume setting is changed and it will not produce a sound even when a button is pressed.

\* The setting is memorized even when the machine is turned off and on.



## ⑧ Language setting

You can select language from 8 languages or pictographs.  
(Default setting is English.)



Example) Change the language to Italian.

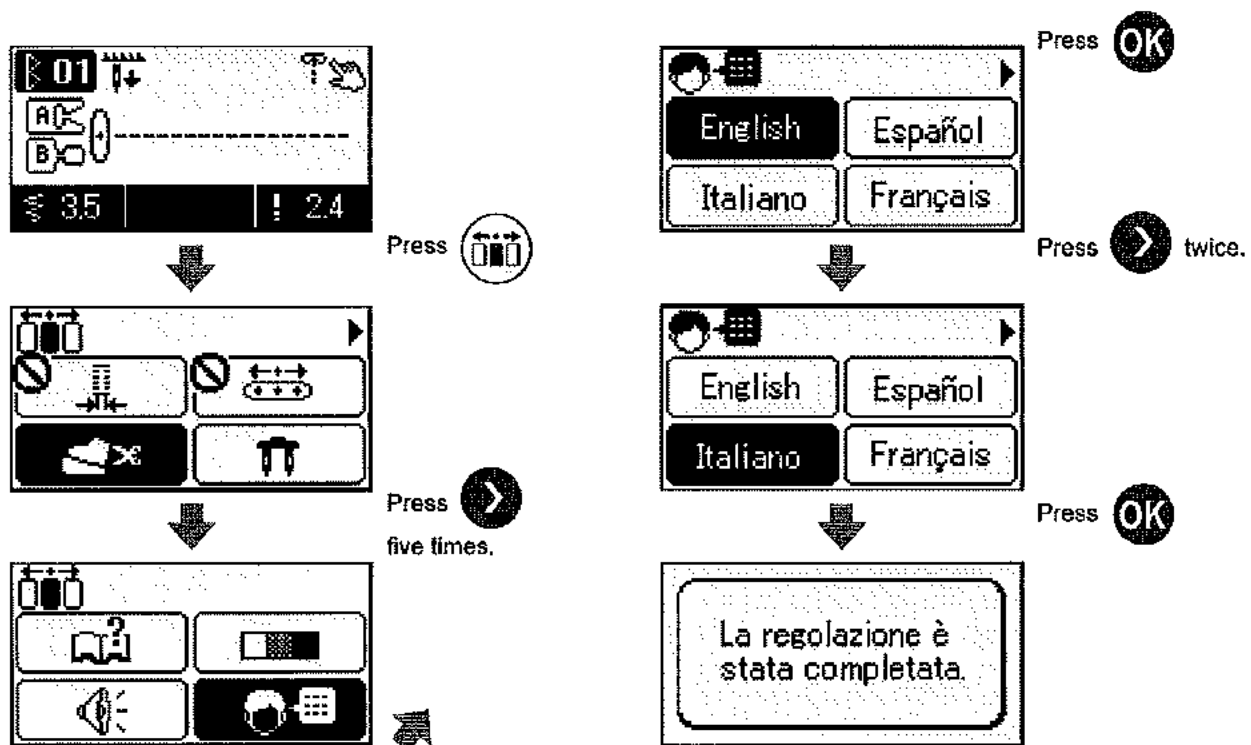

The language is now changed to Italian and all messages will be displayed in Italian from now on.

\* The setting is memorized even when the machine is turned off and on.

## ⑨ Elongation

|             |      |                 |
|-------------|------|-----------------|
| Pattern No. | F600 | One-point 24~38 |
|             | F400 | One-point 24~33 |
|             | F300 | One-point 13~18 |

The length of the patterns (stitch pattern **F600** No.24 ~ 38, **F400** No.24 ~ 33, **F300** No.13 ~ 18) can be adjusted.



↑ Adjusting range is from size 1 to size 5. (Default setting is size 3.)

### Example) changing to size 5

\* Select a pattern which size can be elongated.

Press

Press

Press









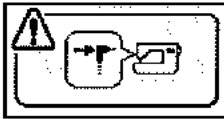
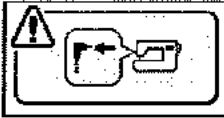
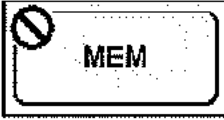

Press

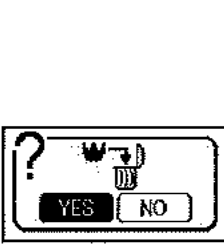
Press

↑ The size is now changed.

\* The setting is memorized even when the machine is turned off and on.

## Message catalog

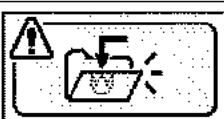
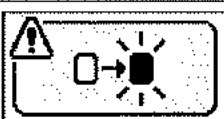
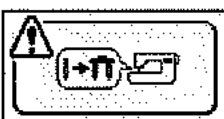
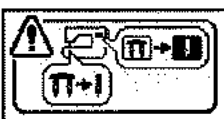
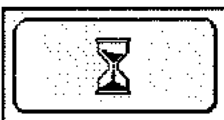
|    | Message   | Cause (Reason to display such messages)  |
|----|---|--|
| 1  |    | A. When "start/stop", "reverse stitch" or "thread-trimming" button is pressed while the presser foot is raised.<br>B. When presser foot is raised while sewing.  |
| 2  |    | A. When one of the buttonhole stitches is selected and the buttonhole sensor pin is not connected, the machine starts to sew.  |
| 3  |    | A. When a stitch pattern other than buttonholes is selected but the buttonhole sensor pin is connected, the machine starts to sew.   |
| 4  |    | A. When in the  mode, user attempts to select stitch patterns more than the maximum number of memory (70).  |
| 5  |   | A. When in the  mode and more than one stitch pattern is selected, user attempts to move to mode  and/or  .<br>B. When in the  mode and more than one stitch pattern is selected, user presses the  button for more than two seconds (deleting all).<br>C. When in the  mode and more than one stitch pattern is selected, user presses the  button (calling a memory). |
| 6  |  | A. When the process of saving a pattern into folder is completed.  |
| 7  |  | A. When in the option setting, settings which will be kept after turning off the machines are changed. (Thread trimming by foot controller, LCD contrast, buzzer volume and language setting)  |
| 8  |  | A. When the setting of the machine is changed to twin needle sewing (option setting).  |
| 9  |  | A. When in twin needle sewing, a stitch pattern other than twin needle sewing is selected.   |
| 10 |  | A. When the motor is locked, the machine stops temporarily for safety.   |

## Introduction of optional accessory parts

Make your home sewing more pleasant!

Please purchase the following items in the shop where you buy our products.

### ● Rolled hemming presser foot

Fabric edge is hemmed while rolling it under. Used for bottom of shirts, blouses, frills and the edge of handkerchiefs.

F600 F400 F300

### ● Binder presser foot

It is possible to attach tapes such as bias tape into four folds.

F600 F400 F300

### ● Button attaching presser foot

This presser foot is used to attach buttons on garments.

F600 F400 F300

### ● Hemming presser foot for zigzag

Fabric edge is hemmed by zigzag while rolling it under. Used for bottom of shirts, blouses, frills and the edge of handkerchiefs.

F600 F400 F300

### ● Quilt presser foot (transparent type)

It is used for free-motion quilting. Zigzag stitch is also possible with this presser foot.

F600 F400 F300

### ● Quilt presser foot (open type)

It is used in free motion sewing. As the front portion is open, it is easy to see the needle entry point.

F600 F400 F300

### ● Cording and Embroidery presser foot

It is used in free motion quilting and a cord can be sewn together with this presser foot.

F600 F400 F300

### ● Appliqué presser foot

Since the front and back of the presser foot is short, it is easy to move the materials at curve points. Also fabrics can be seen easily because it is transparent.

F600 F400 F300

### ● Pearl attaching presser foot

With this presser foot it is possible to attach pearls, beads and thick cord.

F600 F400 F300

### ● Cording presser foot (for 3 cords)

It is possible to attach 1 - 3 cords by three-point zigzag or decorative stitch.

F600 F400 F300

### ● Presser foot with guide

As the presser foot has markings, which show 2 mm distance, these marking will serve as a guide.

F600 F400 F300

### ● Invisible zipper foot

As a seam does not appear on the right side of the fabric, an opening can be finished with fabric edges neatly butted.

F600 F400 F300

### ● Throat plate for straight stitch

Use with patchwork presser foot for better stitch quality.

F600 F400 F300

• **Smooth presser foot**

This presser foot is used for non-slippery materials like vinyl and satin stitches.

F400 F300

• **Walking foot**

This presser foot is used for "difficult-to-feed" materials such knit, jerseys, vinyl, artificial leather and leather or quilting.

F300

• **Eyelet punch**

This is to open hole at round area of keyhole buttonhole.

F400 F300

• **Auxiliary spool pin**

This spool pin is used for twin needle sewing or for bobbin thread winding.

F300

• **Wide Table**

For sewing large projects such as quilts, etc.

F400 F300

• **Quilt presser foot**

This presser foot is used for quilt stitches (free motion quilting).

F300

• **Open toe presser foot**

This presser foot is used for appliqué and decorative stitches. (Front part of the presser foot is open for better visibility.)

F400 F300

• **Patchwork presser foot**

This presser foot is used for patchwork stitches.

F300

• **Edge sewing presser foot**

This presser foot is used for patchwork, sewing center line of joined materials by using the center guide of the presser foot.

F400 F300

• **Quilt guide**

This is a guide is to sew lines in the same distance.

F300

• **Knee lifting lever**

You can raise or lower presser foot by knee, without using your hand.

F300

## How to install Wide Table

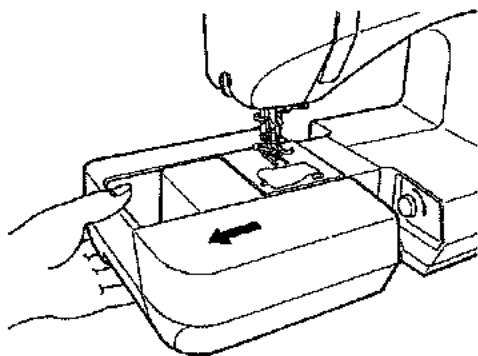

**1** Remove auxiliary bed.

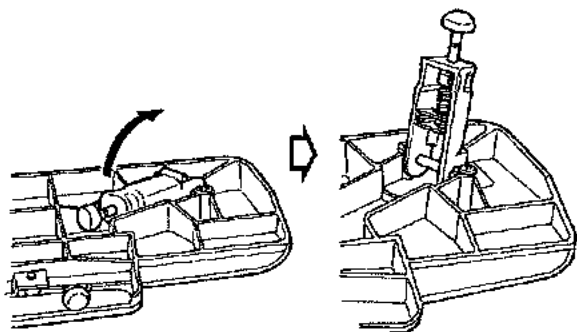

**2** Open legs of Wide Table until they stop securely at the stopping position.

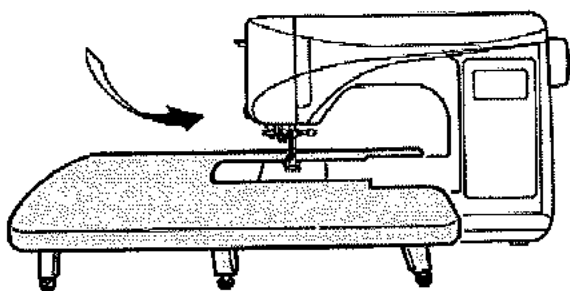

**3** Assemble Wide Table to sewing machine body.

Attach it to free arm of sewing machine.

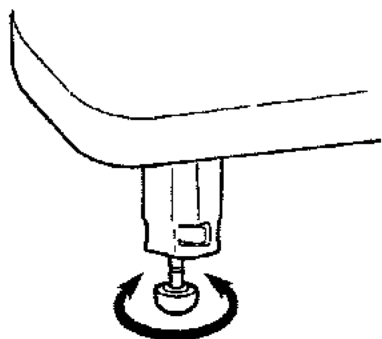

**4** Adjust the height of legs so that the top surface of Wide Table is the same height of sewing machine body.

**▲ Attention**

- \* Don't put any heavy materials on the Wide Table.
- \* Don't move sewing machine with Wide Table attached.

# Machine Maintenance

When lint and/or dirt has built up, it may cause machine failures. Therefore, clean the machine frequently.

## Attention

Turn off the power and disconnect the plug from the wall outlet before maintaining the machine.

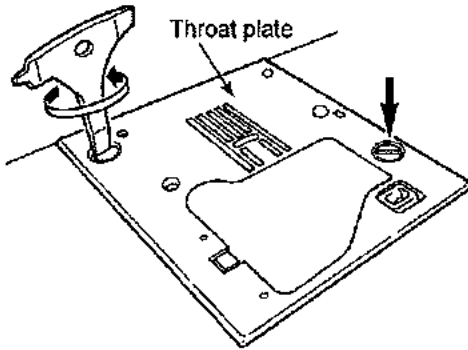

### 1 Remove the throat plate

Remove needle and presser foot and remove the needle plate by using T-shape screwdriver.

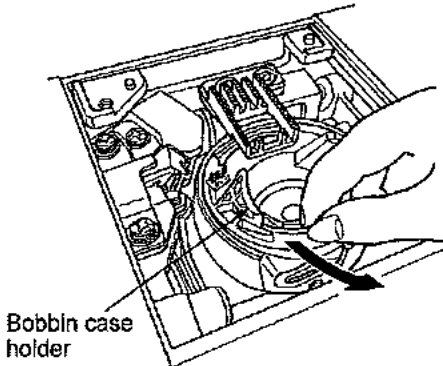

### 2 Remove the bobbin case holder.

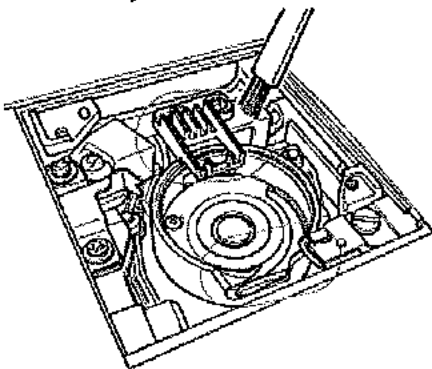

### 3 Remove lint and dirt.

Remove lint and dirt around the feed dog and bobbin case holder with the cleaning brush.

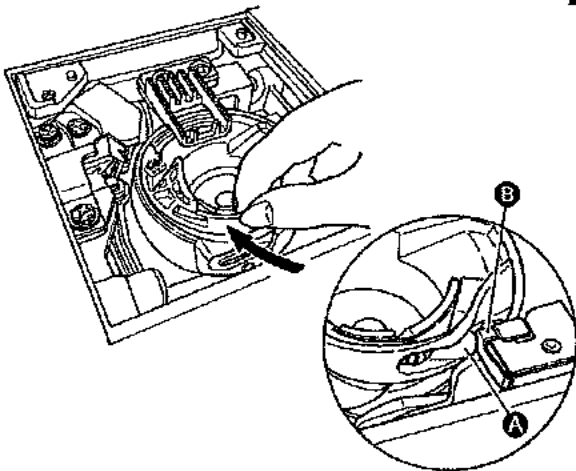

### 4 Install the bobbin case holder.

Install the bobbin case holder so that points **A** and **B** touch each other.

#### Install the throat plate.

When attaching the throat plate, align the positioning pins with holes of throat plate.

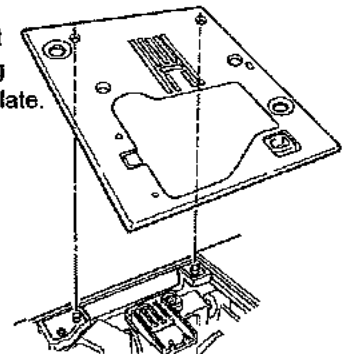

## Performance check list

If sewing difficulties occur, make sure the instructions are correctly followed.



If a problem still exists, the reminders below may help solve it.











| Case  | Cause (Reason)   | Solution  | Reference page      |
|---|--|---|---------------------|
| <ul style="list-style-type: none"> <li>The machine stops sewing suddenly. (This is in case you can turn hand wheel by hand.)</li> </ul>   | <ul style="list-style-type: none"> <li>The machine sews at slow speed continuously. (The machine has a mechanism to automatically cut off the power to prevent the motor from overheating.)</li> </ul>   | <ul style="list-style-type: none"> <li>Turn off the power and wait for a while (about 10 minutes). The safety mechanism will be reset and the machine will return to normal.</li> </ul>   | 2                   |
| <ul style="list-style-type: none"> <li>The machine will not work even when started.</li> </ul>  | <ul style="list-style-type: none"> <li>Presser foot is in up position.</li> </ul>  | <ul style="list-style-type: none"> <li>Lower the presser foot and start to sew.</li> </ul>  | -                   |
| <ul style="list-style-type: none"> <li>The machine will not work even when start/stop button is pressed. (This is in case sewing light is still on.)</li> </ul>   | <ul style="list-style-type: none"> <li>The needle hits presser foot due to an installation of incorrect presser foot.</li> <li>The needle fell into the hook area and tried to start.</li> </ul>   | <ul style="list-style-type: none"> <li>Use the appropriate presser foot to the selected stitch pattern.</li> <li>Remove the needle from the hook area.</li> </ul>   | -<br>-              |
| <ul style="list-style-type: none"> <li>Needle breaks.</li> </ul>  | <ul style="list-style-type: none"> <li>Thick material is sewn with a thin needle.</li> <li>The needle is not inserted fully.</li> <li>The needle setscrew is not securely tightened.</li> <li>The wrong presser foot is used for a certain pattern.</li> </ul> | <ul style="list-style-type: none"> <li>Check the combination of fabric, thread and needle.</li> <li>Check the installation of needle.</li> <li>Securely tighten the needle setscrew.</li> <li>Check the combination of stitch pattern and presser foot to be used.</li> </ul> | 24<br>23<br>23<br>- |
| <ul style="list-style-type: none"> <li>Loud noise and/or keen noise while sewing</li> </ul>   | <ul style="list-style-type: none"> <li>Lint or dust has accumulated in the feed dog.</li> <li>Lint or dust has accumulated in the hook.</li> </ul>   | <ul style="list-style-type: none"> <li>Clean the feed dog area.</li> <li>Clean the hook area.</li> </ul>  | 94<br>94            |
| <ul style="list-style-type: none"> <li>Machine fails to feed fabrics.</li> </ul>  | <ul style="list-style-type: none"> <li>The stitch length is set at "0".</li> <li>Soft fabrics such as towels are being sewn.</li> <li>The machine is set in drop feed condition. (the drop feed knob is on the right side)</li> </ul>                          | <ul style="list-style-type: none"> <li>When the stitch pattern is reselected, the machine goes back to the default setting.</li> <li>Set the stitch length to 3 – 5.</li> <li>Set the drop feed knob to left side.</li> </ul>   | 36<br>-<br>26       |
| <ul style="list-style-type: none"> <li>Needle can not be threaded. (This is in case needle threader will not turn.)</li> <li>The hook of needle threader does not go through the needle eye.</li> </ul> | <ul style="list-style-type: none"> <li>The needle is not in the up position. (When needle is not in the up position, needle threader will not turn. This is to avoid damages to the hook.)</li> <li>The needle is not inserted fully.</li> </ul>               | <ul style="list-style-type: none"> <li>Rotate the hand wheel and lift the needle upwards.</li> <li>Check the installation of the needle.</li> </ul>   | 21<br>23            |



















| Case   | Cause (Reason)   | Solution  | Reference page                                   |
|--|--|---|--|
| <ul style="list-style-type: none"> <li>The needle threading lever will not return to the original position and the machine can not turn properly. (This is in case the hook of needle threader remains in the needles eye.)</li> </ul> | <ul style="list-style-type: none"> <li>Hand wheel is turned by mistake while the needle threading lever is in down position. (in the process of threading to the needle.)</li> </ul>   | <ul style="list-style-type: none"> <li>Turn hand wheel slightly away from you. (to the opposite side when sewing).</li> </ul>   | -  |
| <ul style="list-style-type: none"> <li>The machine will not start even when start/stop button is pressed.</li> </ul>   | <ul style="list-style-type: none"> <li>The foot controller is plugged in.</li> </ul>   | <ul style="list-style-type: none"> <li>Start/stop button can function when foot controller is removed.</li> </ul>   | 8  |
| <ul style="list-style-type: none"> <li>Thread breaks.</li> <li>Stitch is skipped.</li> </ul>   | <ul style="list-style-type: none"> <li>The machine is incorrectly threaded.</li> <li>There is knot or knurl on the thread.</li> <li>The setting of manual thread tension is incorrect.</li> <li>The needle is bent or the tip of needle is broken.</li> <li>The needle is installed incorrectly.</li> <li>Threading of bobbin thread is not correct.</li> <li>The bobbin can not turn smoothly inside the hook holder.</li> <li>The needle size does not match the thread.</li> <li>Thread take-up is not threaded.</li> </ul> | <ul style="list-style-type: none"> <li>Rethread the machine correctly.</li> <li>Remove knot or knurl from thread.</li> <li>Adjust thread tension manually according to fabrics and thread to be used.</li> <li>Change needle.</li> <li>Install needle correctly.</li> <li>Check the correct way of setting bobbin thread.</li> <li>Check the correct way of winding bobbin thread.</li> <li>Check the combination of thread and needle.</li> <li>Rethread the machine correctly.</li> </ul> | 19<br>-<br>25<br>23<br>23<br>17<br>-<br>24<br>19 |
| <ul style="list-style-type: none"> <li>Thread tension is not good.</li> </ul>  | <ul style="list-style-type: none"> <li>The needle thread is threaded in correctly.</li> <li>The bobbin thread is threaded incorrectly.</li> <li>The direction of spool cap doesn't match the spool.</li> </ul>   | <ul style="list-style-type: none"> <li>Rethread the machine correctly.</li> <li>Check the correct way of setting bobbin thread.</li> <li>Attach the spool cap in a correct direction.</li> </ul>  | 19<br>17<br>19                                   |
| <ul style="list-style-type: none"> <li>Puckering occurs.</li> </ul>  | <ul style="list-style-type: none"> <li>The stitch length is too large on light-weight fabrics.</li> <li>The needle tip is broken.</li> </ul>   | <ul style="list-style-type: none"> <li>Make the stitch length smaller (shorter).</li> <li>Change needle.</li> </ul>   | 36<br>23   |
| <ul style="list-style-type: none"> <li> sign is shown on the LCD display.</li> </ul>  | <ul style="list-style-type: none"> <li>Safety mechanism works when machine stops due to motor lock.</li> </ul>   | <ul style="list-style-type: none"> <li>The safety mechanism will be reset in a short while (about 10 minute) and the machine will return to normal. (At this time, the start/stop button will not light up.)</li> </ul>   | -  |







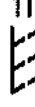



# List of stitch patterns





















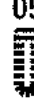

1 
 2 
 3 
 4 
 5 
 6 
 7 
 8 
 9 
 0 





























01 
 02 
 03 
 04 
 05 
 06 
 07 
 08 
 09 
 10 
 11 
 12 
 13 

14 
 15 
 16 
 17 
 18 
 19 
 20 
 21 
 22 
 23 























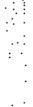















01 
 02 
 03 
 04 
 05 
 06 
 07 
 08 
 09 
 10 
 11 
 12 
 13 
 14 
 15 



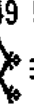



















01 
 02 
 03 
 04 
 05 
 06 
 07 
 08 
 09 
 10 
 11 
 12 
 13 
 14 
 15 
 16 
 17 

**Patterns for crazy quilt**

18 
 19 
 20 
 21 
 22 
 23 
 24 
 25 
 26 
 27 
 28 
 29 
 30 
 31 
 32 
 33 
 34 

35 
 36 
 37 
 38 
 39 
 40 
 41 
 42 
 43 
 44 
 45 
 46 
 47 
 48 
 49 
 50 
 51 

52 
 53 
 54 
 55 
 56 
 57 
 58 
 59 
 60 
 61 
 62 
 63 
 64 
 65 
 66 
 67 



# List of stitch patterns

Icons:

1 2 3 4 5 6 7 8 9 0

Icons: +

01 02 03 04 05 06 07 08 09 10 11 12 13

14 15 16 17 18 19 20 21

Icons: +

01 02 03 04 05 06 07 08 09 10 11 12 13 14 15

Icons: +

01 02 03 04 05 06 07 08 09 10

11 12 13 14 15 16 17 18 19 20

21 22 23 24 25 26 27 28 29

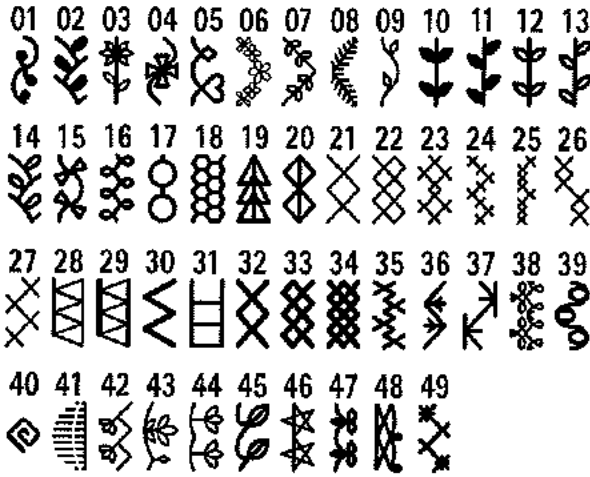

One-point



Pattern for elongation

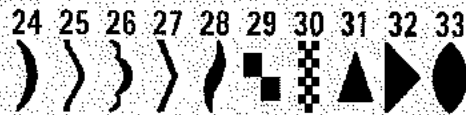

Letters/numbers/signs



@!&' ( ) . . ? - - / : ;  
 ABCDEFGHIJKLMNOPQRSTUVWXYZ  
 abcdefghijklmnopqrstuvwxyz  
 1234567890  
 ÄÅÆäääëèéëÇçİİñÑÖøöÙüü

@!&' ( ) . . ? - - / : ;  
 ABCDEFGHIJKLMNOPQRSTUVWXYZ  
 XYZ  
 abcdefghijklmnopqrstuvwxyz  
 1 2 3 4 5 6 7 8 9 0  
 ÄÅÆäáâãäåääëèéëÇçİİñÑÖøðóôõœÙüü

@!&' ( ) . . ? - - / : ;  
 A B C D E F G H I J K L M N O P Q R S  
 T U V W X Y Z  
 a b c d e f g h i j k l m n o p q r s t u v w x y z  
 1 2 3 4 5 6 7 8 9 0  
 Ä Å Æ ä å ä ä ä ä ä ä ä ä Ç ç İ İ ñ Ñ Ö ø ö ö ö ö ö œ Ù ü ü

# List of stitch patterns

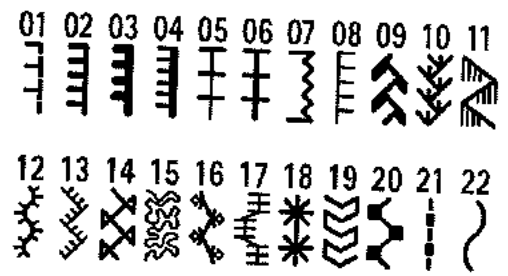
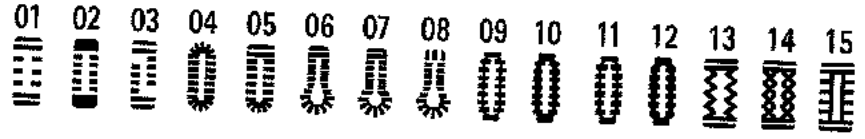
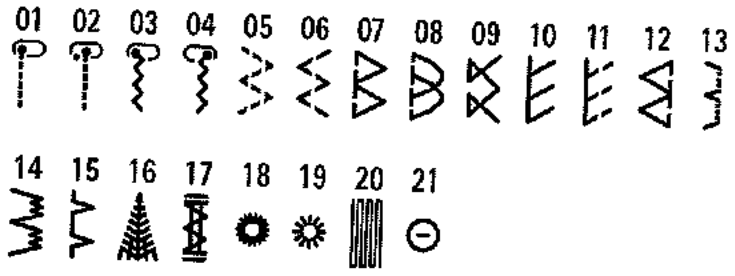
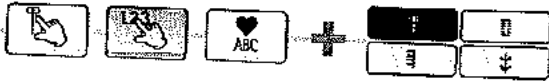
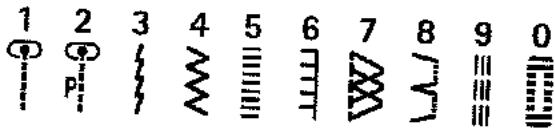

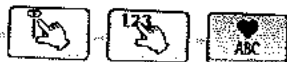

One-point

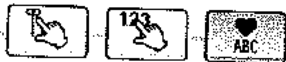
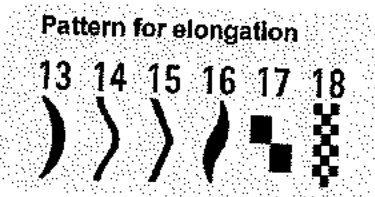
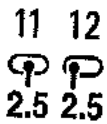
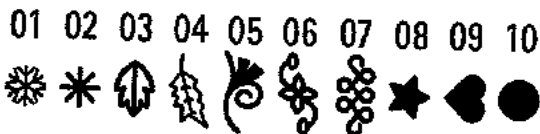

Letters/numbers/signs

@!&' ( ) . . ? - - / : ;  
 ABCDEFGHIJKLMNOPQRSTUVWXYZ  
 abcdefghijklmnopqrstuvwxyz  
 1234567890  
 ÄÅÆääääééééÇçÈèÎîÏïÖöÙù

@!&' ( ) . . ? - - / : ;  
 ABCDEFGHIJKLMNOPQRSTUVWXYZ  
 XYZ  
 abcdefghijklmnopqrstuvwxyz  
 1234567890  
 ÄÅÆääääééééÇçÈèÎîÏïÖöÙù

@!&' ( ) . . ? - - / : ;  
 ABCDEFGHIJKLMNOPQRS  
 TUVWXYZ  
 abcdefghijklmnopqrstuvwxyz  
 1234567890  
 ÄÅÆääääééééÇçÈèÎîÏïÖöÙù

## ■ Specification list

| Item                           | Specification                     |
|--------------------------------|-----------------------------------|
| Body size                      | 44.5 (W) X 29.1 (H) X 21.0 (D) cm |
| Body size with hard case       | 51.0 (W) X 30.5 (H) X 25.7 (D) cm |
| Weight (Weight with hard case) | 9.8 KGS / 21.6 LBS                |

# JUKI®

JUKI CORPORATION

8-2-1, KOKURYO-CHO,  
CHOFU-SHI, TOKYO 182-8655, JAPAN  
PHONE : 03(3480)2458  
FAX : 03(3480)5037

Copyright © 2009 JUKI CORPORATION  
All rights reserved throughout the world.

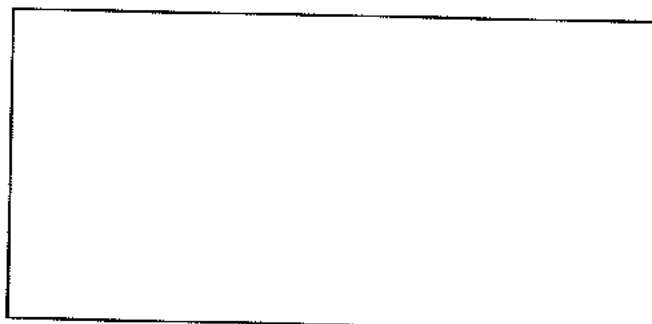

F6 000209