

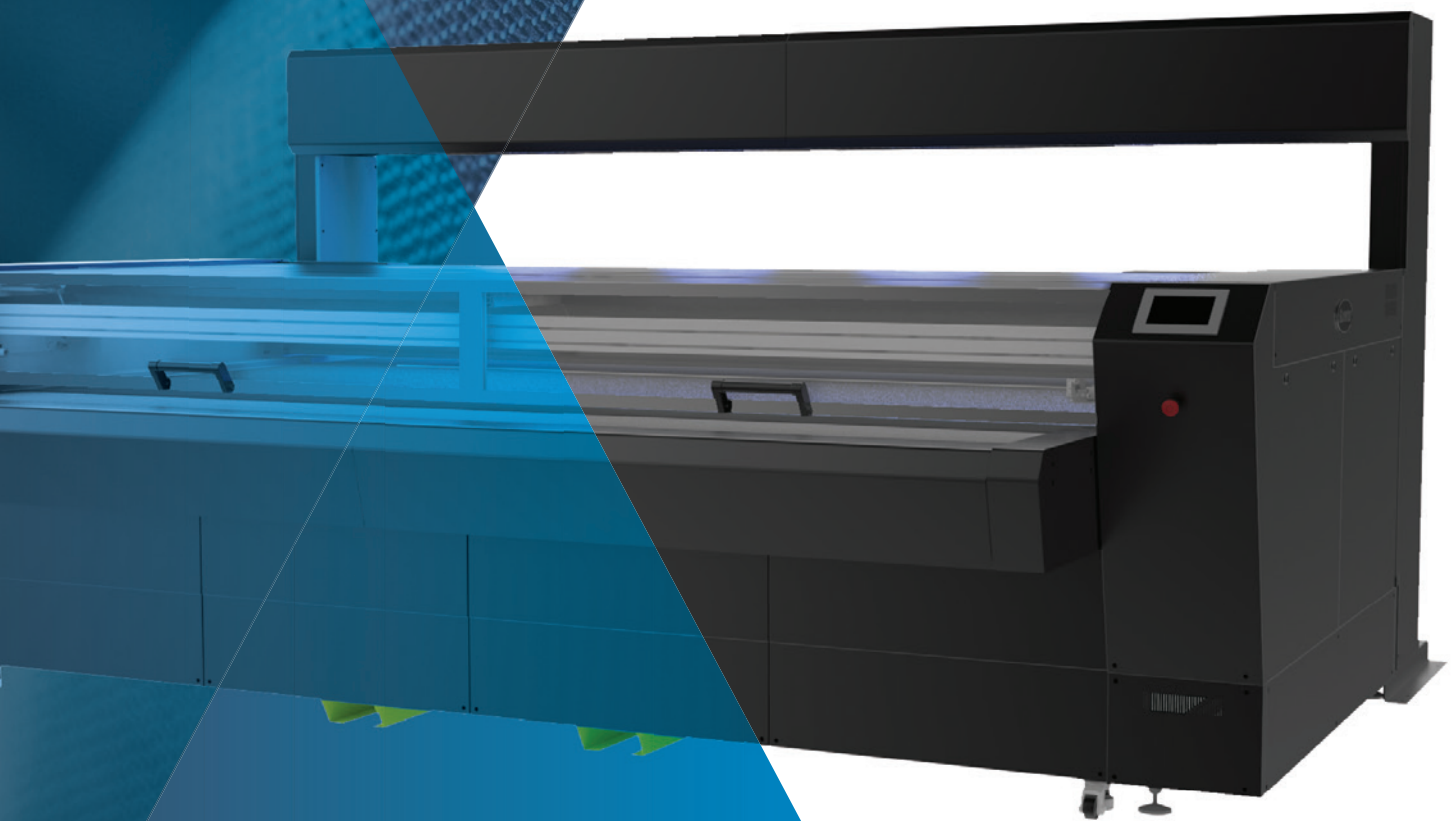

# SUMMA L SERIES

Advanced laser cutters  
for fabrics and textiles



Summa.com | #SummaFinish



# ABOUT SUMMA

---

Summa is a manufacturer of innovative cutting equipment that helps companies and people to finish their applications to the highest standards. Delivering outstanding quality conforming these high standards, has secured the Summa reputation for legendary performance.

Companies from all over the world use Summa cutting solutions for products in the printing, signage, display, apparel and packaging industry. With the cutting solutions from Summa your business is future-proof for many years to come.

[Summa.com](http://Summa.com) | [#SummaFinish](https://twitter.com/SummaFinish)



---

**About Summa** **02**

---

**Summa Laser Cutting Solutions** **04**

---

Summa laser cutters represent the right equipment for businesses who want to bring their print and finishing capacity in line, level up productivity and boost workflow efficiency.

**Laser Cutting Technologies** **10**

---

Several advanced technologies transform the Summa laser cutters into productive workhorses, ensuring optimised and automated workflows.

**Cut-on-the-Fly** **11**

**Cut-to-Frame** **12**

**Trace & Cut Work Method** **13**

**Barcode Workflow** **14**

**Advanced Media Handling** **15**

**Summa L Series Range** **18**

---

Set new standards for high-quality cutting with the Summa L Series laser models, developed to grow with your business.

**Summa L1810** **20**

**Summa L3214** **21**

**Summa GoProduce Software** **22**

---

The GoProduce Laser edition is a powerful and intuitive production software for the Summa L Series. It includes several smart features to establish an optimised and automated workflow.

**Technical Specifications** **26**

---

**Order Codes** **27**

---



# SUMMA LASER CUTTING SOLUTIONS

---

The advantages of laser cutting are multiple and applicable to a wide range of materials across all industries. The laser cutting solutions of Summa are solid and powerful, built to deliver the highest cutting quality.

Summa laser cutters represent the right equipment for businesses who want to bring their print and finishing capacity in line, level up productivity and boost workflow efficiency.

Find your cutting solution in the Summa L Series range and choose the configuration your business requires.



---

L Series

## About laser cutting

---

In essence, laser is focused energy and the better the laser beam is focused, the more energy can be used to cut materials. A large amount of focused energy will vaporize the material with high precision. The quality of the laser source is, therefore, very decisive for the final cutting result.

## Advantages of laser cutting in general

---

- Laser cutting delivers high accuracy and precision
- Edge sealing without fraying when cutting synthetic textiles
- No fabric distortion while cutting, because of contactless cutting
- Quick and precise cutting of intricate designs
- Low to no dust generation while cutting
- Constant cutting quality and no tool wear
- Saves significantly on labor cost, tool cost, setup cost

## Production capacity with laser versus knife

---

Knife-cutting technology can hardly meet the production speed of traditional printers and needs a lot of process time due to the up down movement of knife and tool setup for instance.

Therefore, large (profitable) jobs are unrealistic for the capacity of a knife cutter and rush jobs get lost in the job queue. Whereas with a laser cutter, you have more capacity and productivity possibilities to keep up. Work methods such as Cut-on-the-Fly, Trace & Cut and the overall accuracy of laser can be a true gamechanger.

## Laser quality identifiers

### State-of-the-art laser sources

- Usage of renowned brands Luxinar and Universal representing best round shaped laser sources.
- Perfect temperature regulation of the metal tubes for constant and precise cutting results.

### Laser Power

- Increasing the power generally increases the cutting speed.
- The required power is related to production volume and applications.

### Laser cooling technology

- Optimal cooling keeps the laser beam focused and ensures the laser beam to maintain an even distribution of power for longer production runs.
- Air cooled systems are used for lower power ranges and are recommended for shorter production runs.
- Water cooled systems are extremely stable enabling a full continue production maintaining the same high quality.

## Laser cutting with Summa

The laser cutters from Summa are focused on productivity and delivering high quality results. The cutters are equipped with renowned Luxinar and Universal laser sources ensuring high precision, consistently.

- High speeds and quick acceleration thanks to positioning of the laser source on the chassis, keeping the laser nozzle lightweight.
- Accurate cuts even of most intricate details through camera recognition.
- Optimized for cutting a wide range of substrates.
- Edges are sealed and soft without fraying.
- Level-up production capacity thanks to the ability to cut while the material is being fed (Cut-on-the-Fly).
- Ease of use through automated options and smart media handling.
- Safe operation with the Class 1 safety classification; covered laser source and extraction of fumes.
- Powerful and intuitive software, built to match seamlessly with the Summa laser cutting systems.

### Boost workflow efficiency with Summa laser cutting

Laser cutters enable you to upgrade your production capacity while delivering high quality. Set new standards with unrivalled Summa laser cutting technology now and for many years to come.

BOOST WORKFLOW  
EFFICIENCY WITH SUMMA  
LASER CUTTING



Laser cutter range:  
Summa L1810 & Summa L3214

## Applications

Across many segments, businesses are detecting needs in their original industry and are finding solutions in laser cutting. The range of applications for laser cutting is therefore broad and keeps expanding.

### S Soft Signage

Eye-catching, large and versatile are the applications for laser cutting in soft signage.

- Tradeshow graphics
- Backlit displays
- Retail store décor elements
- Flags & banners



### 👕 Sportswear/Clothing

Sportswear requires a most accurate cut with sealed edges simplifying further finishing processes.

- Dye sublimation prints
- Sportswear
- Fashion



### 🎯 Technical Textiles

When processing technical textiles there is no room for errors. To achieve such quality, precise cutting with advanced laser equipment is necessary.

- Seatbelts
- Swimming pool filtration
- Medical mesh
- Airbags



### 🏠 Interior Decoration

The applications for interior decoration are diverse, they can also include custom designs for individual customers.

- Pillow covers
- Rugs and blankets
- Upholstery
- Textured wall art



# FUNDAMENTAL FIVE+

---

Today's laser equipment from Summa is a result of continuous research and further development of earlier products. Technology has evolved and modern laser systems are safer, more productive and easier to use.

1

## Power: OptiPower Technology

---

With Summa OptiPower technology the laser beam remains focused and constant. A key element of OptiPower technology is the temperature regulation of the laser tube. Summa laser cutters use a metal sealed CO<sub>2</sub> RF laser source. Combined with the cooling system, the laser beam will maintain an even distribution of power. The cutting result will be the same over the complete cutting surface and consistent during the entire time of production.

2

## Precision Quality

---

The concentrated power of the laser on a very small focal spot size, allows the laser cutter to cut designs with the highest precision. It is thanks to this degree of precision, that the edges are sealed and soft without fraying, which is ideal for ready-to-use textiles.

3

## Safety: Class 1

---

Summa laser cutters are classified for Class 1 safety. The cutters use a closed system, protecting the laser source with a cover. This way, gases that are released stay inside and are taken away via the extraction system. It is also thanks to this extraction system that Summa laser cutters do not leave any burn marks (discolouration) on the material.

When the cover is opened, the cutting head pauses, and the laser beam is blocked by a mechanical arm. When the cover is closed again, the job can be resumed where it paused. Other safety precautions include a shield in front of the laser cutter and finger latches.

4

## Stability

---

The chassis of the new L1810 2<sup>nd</sup> generation is made from welded steel, making it an incredibly stable base for the laser cutter. This stability highly benefits the level of accuracy. Moreover, the firm construction allows for easier placement, installation and maintenance.

The firm construction allows for several options to retrofit. It enables customers to enhance their cutter at a later stage, so it can grow alongside their business' aspirations and goals.



# 5

## Productivity

The highly performant Summa laser cutters can boost productivity thanks to smart features such as the optional Vision System. It uses integrated cameras to scan marks, black outlines or barcodes, fast and accurately. It is also possible to scan, feed and cut at the same time. This time saving process is called 'Cut-On-the-Fly'.

With the laser cutters from Summa, rush jobs that generate good business can be accepted, also bulk orders and peak production can be perfectly accommodated. Cutting is no longer a time-consuming task, it becomes just as fast or even faster than the printing process.

## Powerful software enabling workflow automation

With the GoProduce software for laser, Summa developed powerful and intuitive production software for its range of laser cutters. It includes several smart, easy-to-use options and features to establish an automated workflow where operator comfort is key. For instance, the barcode functionality allows to automatically process an entire roll of textile with different cutting jobs, without operator intervention.

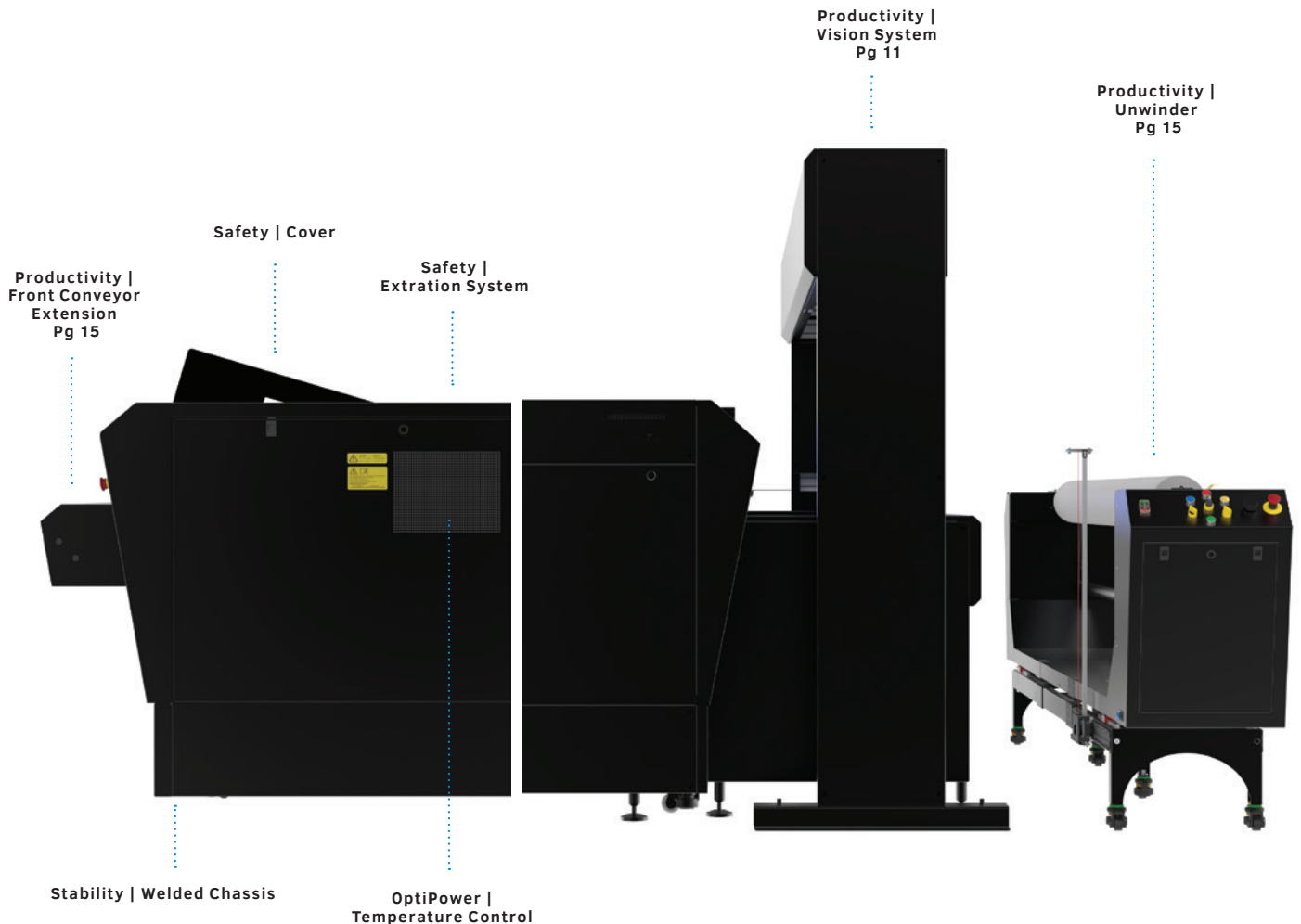

Left side: L1810

Right side: L3214

# LASER CUTTING TECHNOLOGIES

---

Summa laser cutters are based on several advanced technologies, transforming them into productive, operator-friendly workhorses that ensure excellent automated and optimised workflows.

Additionally, effective media handling contributes to the process efficiency and to achieving qualitative results.

It is thanks to the many retrofittable options and features, Summa laser cutters will grow along with your business at your own pace, which makes them the ideal future-proof investment for many years to come.



# CUT-ON-THE-FLY

The laser cutters from Summa are making a significant difference with their ability to cut on the fly. This means the Summa laser cutter will keep on cutting while scanning and feeding the material simultaneously.

## Key benefits:

- Faster processing of jobs
- Contributing to workflow efficiency
- Increasing production capacity

## Requirements:

- Vision System
  - L1810: Optional
  - L3214: Standard included
- GoProduce Laser Edition



## How it works

When the material is being fed to the cutter, the design is immediately scanned by the integrated cameras of the Vision System. Cutting starts when the first part is scanned and fed forward. At the same time, the next part is already being fed and scanned. In this efficient process, cutting happens continuously until the job is done.

So, instead of feeding, scanning and cutting each segment of the material separately, the Vision system converts the three steps almost into one single step. The amount of time saved with the Cut-on-the-Fly method is substantial.

### Cut-on-the-fly method

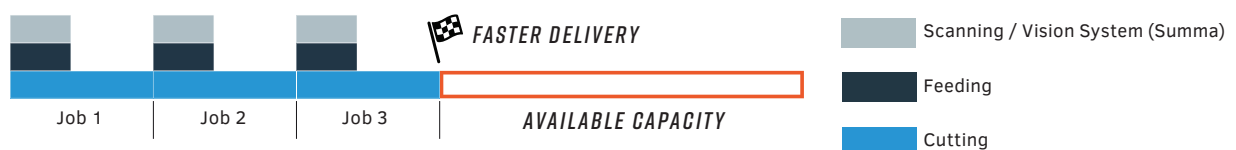

### Traditional working method



Visualization of Cut-on-the-Fly method in comparison with the traditional working method.



# CUT-TO-FRAME

Cutting banners to size can be a true challenge. Taking any shrinkage and deformations into account, the image should be well positioned relative to the frame and the canvas should fit in the frame tightly.

With Summa's Cut-to-Frame functionality, banners will perfectly fit into a frame with the image aligned as desired. This feature is an ideal solution for cutting Silicone Edge Graphics (SEG).

## Key benefits:

- Perfect fit into SEG frames
- No shrinkage or distortions
- No post-processing needed

## Requirements:

- Vision System or Head Camera
- GoProduce Laser Edition



## Cut-to-Frame process

With Summa's own software for laser it is possible to use the Cut-to-Frame functionality, also known as Fixed Size Cutting. It prevents errors, material waste and costs. Combined with the Vision System, it allows for producing jobs that require a fixed size to fit perfectly into SEG frames.

### How it works

1. In pre-production a bleed and registration marks are added to the original artwork.
2. The camera reads the registration marks in the artwork and the software quickly compares the result with the original cut file.
3. Any shrinkage and deformations that occurred during printing and calandring are automatically detected.
4. The positioning of the cutting data is then calculated and placed so the image will fit to the exact frame size.
5. Sewing-in the silicon beading happens faster thanks to the perfectly sealed edges.

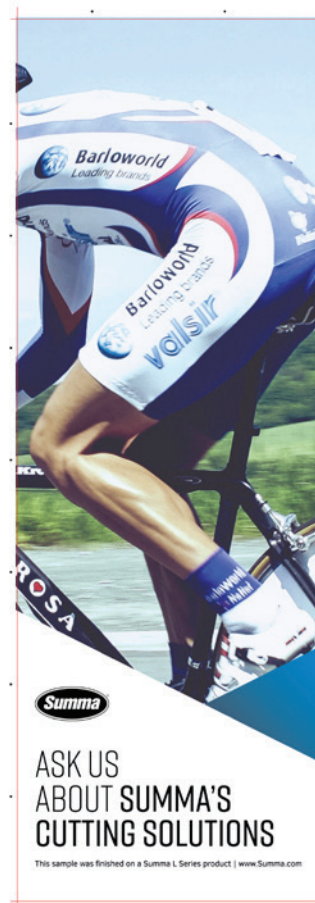

# TRACE & CUT

The Trace & Cut functionality is used to automate the cutting process. This method does not need a cut file. Thanks to the Vision camera System which detects the design and the software which creates a vector file automatically with the scanned data. Also nesting becomes more efficient as no registration marks are required.

## Key benefits:

- Automated contour cutting
- Cut to printed size
- Better nesting of designs
- Improved workflow efficiency
- More operator comfort
- No file searching

## Requirements:

- Vision System
- GoProduce Laser Edition



## Automated cutting process

The Trace & Cut method allows automatic processing of an entire roll with different jobs on the laser cutter without pre-prepared cutting data, offering maximum operator comfort.

There is also no need for printed registration marks creating space for a better nesting of the print designs, optimizing material use and costs. However, where necessary printed registration marks can be used, allowing the intelligent analysis to compensate for any deformations.

## How it works

1. The Trace & Cut method uses the Vision camera System to trace the contours of the artwork. The camera follows a black outline, which has been added to the print design, and detects the cutting area.
2. The software receives the data and automatically creates cut files after each scan, so there is no need to search or import files first.
3. Cutting starts when the first part of the design is scanned and the next part on the roll is scanned simultaneously. So, this work method also enjoys the benefits of the cut-on-the-fly process. Between the parts, the cutter adds a waste cut to split the waste into smaller pieces to avoid pulling on the uncut material.



# BARCODE WORKFLOW

The Summa Barcode Workflow increases the productivity of the laser cutter considerably and the quality of the cut product will be impeccable. This automatic process frees up time for the operator to concentrate on other jobs. In addition, human errors will be reduced to a minimum.

**Key benefits:**

- Workflow automation
- Fast processing of jobs
- Significant production capacity increase

**Requirements:**

- Vision System or Head Camera
- GoProduce Pro Pack Laser Edition software

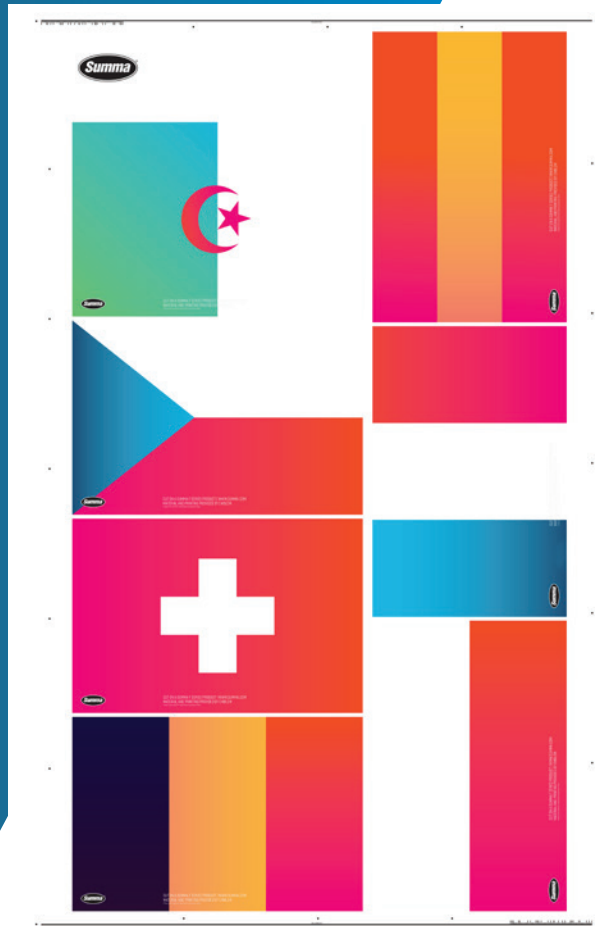

## Advanced Workflow Automation

With the GoProduce software for Summa laser cutters, a strong feature for workflow automation becomes available. Using the Barcode Workflow, it is possible to process an entire roll with different cutting jobs on the laser cutter, without operator intervention.

**How it works**

- Along with the design, a barcode is printed on the material that refers to the corresponding cutting file. Each printed roll can contain different cutting jobs, each of the jobs with its own barcode.
- When the material is scanned with the Vision camera System, the cut file is identified and automatically retrieved by the software. Subsequently, it starts cutting.
- This process will repeat itself until all cutting jobs have been processed.





# ADVANCED MEDIA HANDLING

To enhance efficiency, accuracy and productivity the Summa L Series can be equipped with a number of advanced media handling options.

Ranging from a front conveyor extension to relax the fabric and facilitate material picking, a motorized unwinder for constant, stable material feed, an advanced camera system for workflow automation to different types of planks.

Customise your Summa laser cutter to your particular cutting needs and applications.



L1810 w/ Front Extension, Vision system and Unwinder

## Front Conveyor Extension

A Front Conveyor Extension is ideal for jobs on roll material and helps the operator to remove the cut parts safely and easily.

- L1810: Optional

### Working of the Front Conveyor Extension

The Front Conveyor Extension on the L1810 is ideal for jobs on roll material and will facilitate the operator's life considerably. Once the first part of the cutting job is completed, the conveyor advances the cut material to the extended front, where the operator can remove the cut parts safely and easily.

Meanwhile, the laser can cut the next part of the job in the back. This will minimise idle periods, increase yield and maintain a well-organised working space.

*The front conveyor extension is optional on the L1810 and not retrofittable.*



## Unwinder

---

The motorized Unwinder (de-reeler), ensures that the material is transported to the cutting bed in a constant and stable manner, thus eliminating fabric distortion while cutting. By creating a loop in the material, the unwinder relaxes the material, and secures an accurate cut, even at high production speeds.

- L3214: Standard included  
Unwinder with edge detection incl. droop sensor and tension bar
- L1810: Optional - 2 models available
  - Standard unwinder (with droop sensor)
  - Unwinder with edge detection  
(incl. droop sensor and tension bar)

### Unwinder options and benefits

**Droop Sensor:** ideal for loading thin material

Key benefits: detects when the unwinder has reeled enough slack material and loop is kept constant

**Tension Bar:** ideal for loading stiffer material

Key benefits: stable feed without material sagging or exerting too much power on the laser cutter

**Edge Detection:** for a constant alignment of your material

Key benefits: perfectly even rolling off of textile material

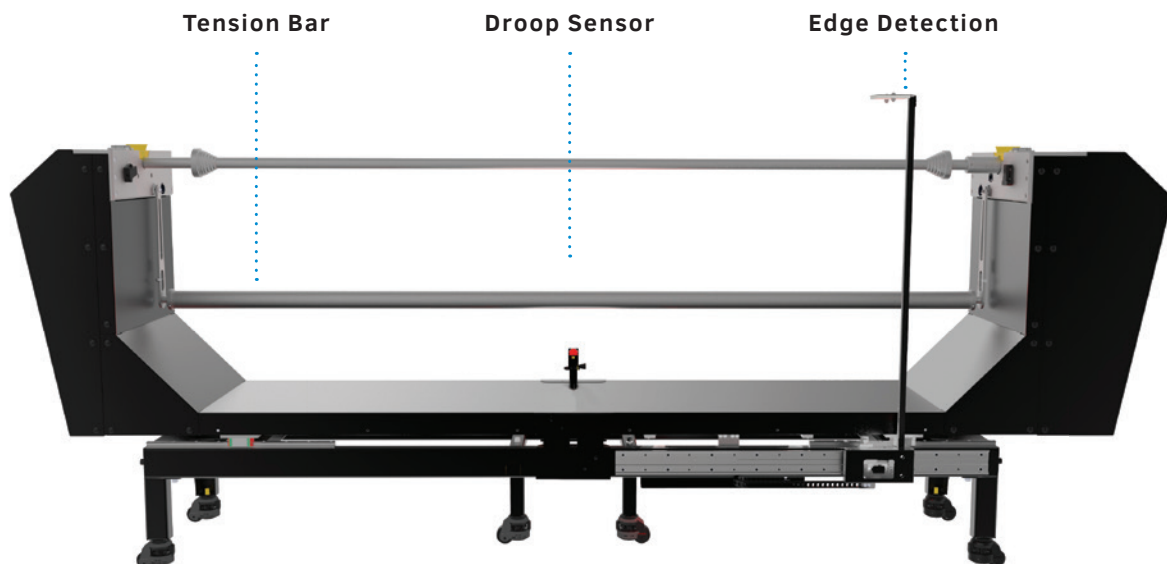

---

L1810 Edge Detect Unwinder

## Vision System

The optional Vision camera System provides state-of-the-art camera recognition for scanning the material. The intelligent camera system enables several work methods, such as Cut-on-the-Fly and Trace & Cut, that boost production efficiency.

- L1810: Optional
- L3214: Standard included



L3214 Vision System

### Exclusive Vision System work methods

#### Cut-on-the-Fly work method:

- Scanning, feeding and cutting simultaneously
- Increases production capacity
- Enables faster processing limiting idle time

#### Trace & Cut work method:

- Automatic contour cutting
- Without pre-prepared cutting file
- More operator comfort

### Other possible work methods with Vision System

#### Cut-to-Frame work method:

- Fixed size cutting
- Ideal solution for SEG frames
- No post-processing needed

#### Barcode workflow:

- Automatic process of different cutting jobs
- Without operator intervention
- Increased production capacity

## Conveyor planks

Summa's conveyor system ensures a continuous production of rolled material and automatically transports cut parts out of the machine. The metal slat or honeycomb construction allows for vacuum extraction from underneath. The material will be held down by means of the vacuum, which will result in a clean cut and precise transport movement through the working area.

- L1810: Configurable choice
- L3214: Standard included (blade planks)

### Blade planks

The blade planks have an optimal fume extraction, have no flashback of the laser, they are easy to clean and durable. These planks are suitable for most applications and ideal for soft signage in particular. It makes loading and unloading much easier.

### Honeycomb planks

The honeycomb planks have an improved extraction of fumes. The structure of these planks provide better grip on the material and keeps the working surface more flat. This solution is best for light weight, slippery and stretch materials.

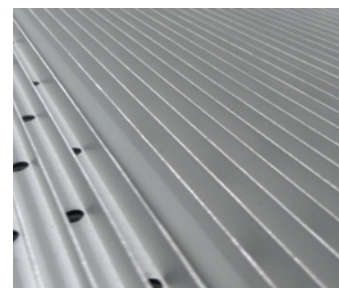

Blade planks

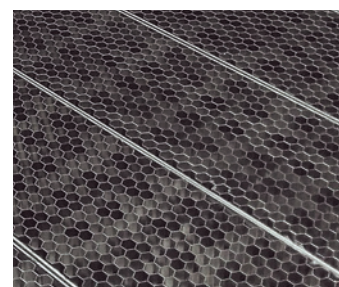

Honeycomb planks



# SUMMA L SERIES

---

The laser cutters from Summa are developed with over 25 years of specialised experience in laser cutting technology. The Summa L Series laser cutters are equipped with best in-market laser sources, advanced camera technology and are classified for safety. Moreover, the powerful production software takes a business' production efficiency to the next level, enabling fast cutting processes and advanced workflow automation.

Set new standards with the Summa L Series laser models and achieve high-quality cutting results.



## Summa Legendary Performance

The L Series laser cutters carry Summa's long-standing reputation for legendary performance. The laser cutters enable businesses to upgrade their production capacity while keeping quality standards consistently high.

### Key features of the series

#### Power

The laser sources have an Optimal Power Control keeping the laser beam focused and constant, even in a larger working area.

#### Precision

The small and focused laser beam vaporizes material with high precision, leaving edges sealed and soft without fraying or discoloration.

#### Safety

The cutters are classified for Class 1 safety. The laser source is fully covered and an effective extraction system ensures a clean environment.

#### Stability

The industrialized welded steel base of the next generation cutters enhances cutting accuracy and allows for easier placement, installation and maintenance.

#### Productivity

Finishing capacity equates printing capacity thanks to the ability to cut while the material is being fed (Cut-on-the-Fly).

#### Software



Production-oriented, in-house GoProduce Laser edition software, tailored to the Summa L Series and including smart features to handle jobs fast and easily.

### Choose your laser power

The quality of the laser source is very decisive for the final cutting result.

Summa offers high-quality Luxinar and Universal laser sources with different power options. This way, you can choose the laser power best suited for your application\*.

*\*Contact your Summa distributor for more detailed information.*

Guidelines			
50 W	Air Cooled	 Intermitted production	<ul style="list-style-type: none"> <li>Engraving applications</li> <li>Thin, light and sensitive textiles</li> </ul>
100 W	Air Cooled		<ul style="list-style-type: none"> <li>Engraving applications</li> <li>Thin, light and sensitive textiles</li> </ul>
120 W	Water Cooled	 Full production	<ul style="list-style-type: none"> <li>Engraving applications</li> <li>Thin, light and sensitive textiles</li> <li>Cutting plastics, thicker materials</li> </ul>
250 W	Water Cooled		<ul style="list-style-type: none"> <li>Recommended for special materials</li> </ul>

# SUMMA L1810

The L1810 laser cutter is especially suitable to cut textiles, such as sportswear, dye sublimation garments but also all sorts of raw materials used in the composite industry.

## Key Benefits

- Small footprint
- Fast and precise cutting
- Safety Class 1
- Retrofittable options

## Cutting Possibilities

### Materials

- Stretchable materials (lycra, spandex, elastane)
- Polyester fabric
- (Technical) textiles
- Felt
- Filtration materials

### Applications

- Sportswear, apparel
- Carpet, matting
- Industrial (seat covers, belts)
- (Fishing) nets
- ....

## Retrofittable options

- Standard Unwinder
- Unwinder w/ Edge Detection
- Vision System

## Workflows

- Cut-on-the-Fly
- Cut-to-Frame
- Trace Workflow
- Barcode Workflow



Summa.com

Technical Specifications	
<b>Model</b>	<b>L1810</b>
<b>Laser Power</b>	50 or 100 Watt (Aircooled) 120 or 250 Watt (Watercooled)
<b>Dimensions</b> <i>(H x W x D)</i>	1172 x 2810 x 2178 mm 1172 x 2810 x 2578 mm <i>(Base with Front Conveyor Extension)</i> 1632 x 2810 x 2178 mm <i>(Base with Vision System)</i> <i>All dimensions are displayed without Unwinder.</i>
<b>Media Width</b>	Up to 1845 mm
<b>Working Area</b>	1840 mm x 950 mm
<b>Speed</b>	Up to 1000 mm/s
<b>Acceleration</b>	Up to 1G
<b>Camera Recognition</b>	OPOS marks Optional: Vision System
<b>Features</b>	Welded Steel base Three phase input Repeatability 0,05% of move or 0.05 mm (whichever is larger)
<b>Standard Solution Includes</b>	Summa GoProduce Laser Edition Conveyor System (with configurable planks) Compressed air drying bowl and flow regulator Head Camera
<b>Options</b>	Summa GoProduce Laser Edition Pro Pack Planks: Blade or Honeycombs Planks Front Conveyor Extension Unwinder Vision System

*Please contact your dealer for more information*

# SUMMA L3214



Summa.com



The L3214 laser cutter is the most productive solution for cutting wide-format soft signage. The key to its productivity is a unique on-the-fly cutting principle to ensure a perfectly cut product, ready to roll off the table.

## Key Benefits

- Very high productivity
- Intelligent Vision camera system
- Large-format cutting

## Cutting Possibilities

### Materials

- Banners & canvas
- Adhesive vinyl
- Polycarbonate
- Polyester

### Applications

- Flags & banners
- Trade show graphics
- Backlit displays
- Retail store décor elements
- Technical textiles
- ...

### Media Handling Features

- Vision System
- Unwinder w/ Edge Detection

### Workflows

- Cut-on-the-Fly
- Cut-to-Frame
- Trace Workflow
- Barcode Workflow



Technical Specifications	
<b>Model</b>	<b>L3214</b>
<b>Laser Power</b>	250 Watt (Watercooled)
<b>Dimensions</b> <i>(H x W x D)</i>	2135 x 4382 x 3800 mm
<b>Max Roll Width</b>	3400 mm
<b>Working Area</b>	3300 x 1400 mm
<b>Speed</b>	Up to 1500 mm/s
<b>Acceleration</b>	Up to 1 G
<b>Camera Recognition</b>	OPOS marks Vision system
<b>Features</b>	Extraction speed control Cageless bearings
<b>Standard Solution Includes</b>	PC and monitor GoProduce Laser Edition Conveyor system Vision system Chiller Air flow pumps Unwinder with edge detection

*Please contact your dealer for more information*

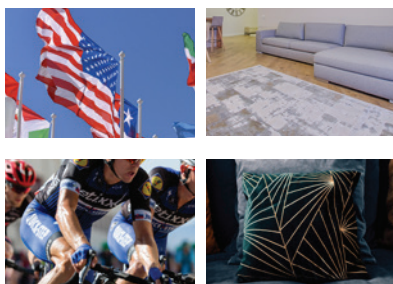





# SUMMA IN-HOUSE DEVELOPED SOFTWARE

The Summa GoSuite software platform has been developed in-house to enable users to make the most of their print and cut workflow. With the Summa software, operators, designers and business owners, can easily process and analyse complex and high volume jobs with great flexibility.

Rely on powerful software to maximise the use of your Summa cutting equipment.



## Summa GoProduce™ Laser Edition

The Summa GoProduce Laser edition is a powerful and intuitive production software for the L Series. It includes several smart, easy-to-use options and features to establish a fully automated workflow where operator comfort is key. Create, customise and set the interface to your needs.



- Modern interface
- Custom configuration
- Quick, intuitive and flexible
- Windows-based
- Standard included
- Pro Pack available
- 30-day Trial available

## Key Features - Standard included

### Material Manager

Allowing to preset speed and other settings linked to the specific method used: Thru-Cut, Kiss-Cut, Registration marks and Engrave.

### Added camera profiles

Added camera profiles for precise and fast processing of different media types, which will add to the robustness of the software. This results in even higher productivity with unrivalled cut quality.

### Trace & Cut

The Trace & Cut functionality uses the Vision system to trace the contours of designs by detecting the black outlines. No cutting file is needed, adding to the automation and reducing downtimes considerably.

### Job log functionality

The GoProduce Laser edition automatically logs every job sent to the cutter. Job Log enables a simple form of post calculation, monitoring of the unit's uptime, tracing of jobs, links to ERP/MIS systems and much more.

### Cut-to-Frame

This functionality enables a perfect fit into SEG (Silicone Edge Graphics) frames. Any shrinkage and deformations that occurred during printing and calandering are automatically detected.

### Waste cut functionality

The waste cut functionality, ensures material is laser cut in a very efficient way so that the cut pieces can easily be picked and handled afterwards.

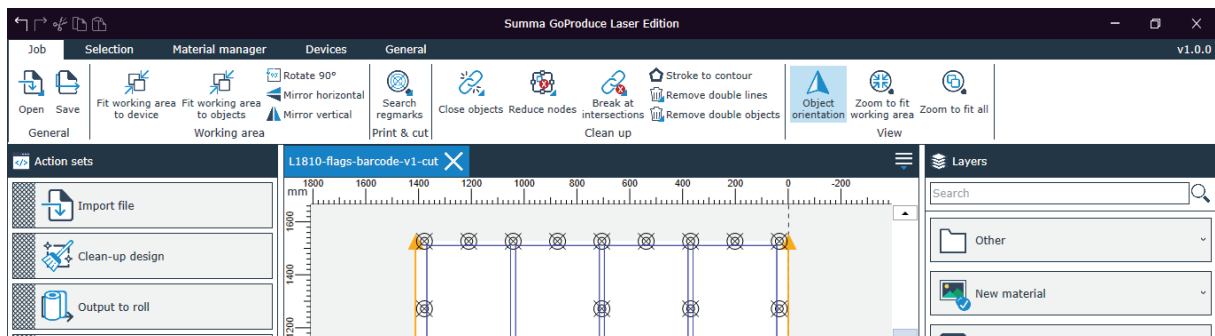

## How to get started

Choose the functionalities you need and discover the software with a free 30-day trial on our website.

### Knowledge Base

Frequently asked questions have been bundled and answered by Summa experts in a knowledge database. Gradually, we will be extending the

database with more tutorials, make-relevant tips and useful tips&tricks. Go to [www.summa.com/faq](http://www.summa.com/faq) or scan the QR code.

### Website:



Free 30-day trial

FAQ

## GoProduce™ Laser Edition Pro Pack

The optional GoProduce Laser Edition Pro Pack offers the advanced features barcode functionality and hot folder support to enhance your cutting workflow even more. Similar to the standard GoProduce Laser Edition software, also the Pro Pack will be gradually expanded with new functionalities.

### Hot folder support

With the hot folder functionality, which is linked to media and action sets, files dropped in a folder can automatically be opened in the GoProduce Laser edition. The flexible action sets ensure that what happens next is fully customisable.

### Barcode functionality

This functionality allows to process an entire roll with different cutting jobs on the laser cutter without the need for digital intervention whatsoever. Free up your operator's time to do other assignments.

GoProduce Laser Edition 1.0	GoProduce Laser Edition 1.0 Pro Pack
<b>Standard available on <a href="http://www.Summa.com">www.Summa.com</a></b>	<b>One-time Pro version purchase (610-8522)</b>
<ul style="list-style-type: none"> <li>• Custom configuration of action sets</li> </ul>	<ul style="list-style-type: none"> <li>• Custom configuration of action sets</li> </ul>
<ul style="list-style-type: none"> <li>• Registration of square / round marks</li> </ul>	<ul style="list-style-type: none"> <li>• Registration of square / round marks</li> </ul>
<ul style="list-style-type: none"> <li>• Material manager</li> </ul>	<ul style="list-style-type: none"> <li>• Material manager</li> </ul>
<ul style="list-style-type: none"> <li>• Job log functionality</li> </ul>	<ul style="list-style-type: none"> <li>• Job log functionality</li> </ul>
<ul style="list-style-type: none"> <li>• Cut-to-Frame functionality</li> </ul>	<ul style="list-style-type: none"> <li>• Cut-to-Frame functionality</li> </ul>
<ul style="list-style-type: none"> <li>• Set parameters in advance</li> </ul>	<ul style="list-style-type: none"> <li>• Set parameters in advance</li> </ul>
<ul style="list-style-type: none"> <li>• Added camera profiles</li> </ul>	<ul style="list-style-type: none"> <li>• Added camera profiles</li> </ul>
<ul style="list-style-type: none"> <li>• Vision Trace functionality</li> </ul>	<ul style="list-style-type: none"> <li>• Vision Trace functionality</li> </ul>
<ul style="list-style-type: none"> <li>• Waste-Cut functionality</li> </ul>	<ul style="list-style-type: none"> <li>• Waste-Cut functionality</li> </ul>
	<ul style="list-style-type: none"> <li>• Barcode functionality</li> </ul>
	<ul style="list-style-type: none"> <li>• Hot folder support</li> </ul>





## Product Registration

Summa recommends users to register their products online. Upon registration of your Summa products, you can activate several features such as the barcode workflow, and so on. Also, in the registration form, you can choose to tick the box if you want to receive our monthly newsletter. This way, you can stay up to date with Summa's latest products and features that might complement your cutting equipment.

All Summa products can be registered through the Summa website.

Go to:  
Product  
Registration



## Inspiring Customer Stories

Customer stories go beyond product leaflets, brochures and other presentations. These real-life views and opinions from people in the field are the actual depiction of a product's benefits as shown in a true production area. So, go ahead and read our blog, which is filled with inspiring customer stories to create innovative and striking applications with our Summa equipment that fits your every cutting need!

Summa  
Blog



## Testimonial: The Look Company

“SIMPLY NO OTHER LASER  
CUTTER MET OUR REQUIRE-  
MENTS UNTIL WE CAME  
ACROSS THE SUMMA L3214”

**Company:** The Look Company

**Core business:** Sportswear, luxury goods and retail

**Challenge:** Accurate & fast cutting of stretchable textiles

**Solution:** Summa L3214

Read the full story at [www.summa.com/blog](http://www.summa.com/blog)



“The ability of the L3214 laser cutter to scan in registrations marks whilst processing the next part is a unique combination, which no other laser cutter in the market can do so well. Simply no other laser cutter met our requirements until we came across the Summa L3214.”

*Image courtesy of The Look Company*

/ Roger Pennell, Director of Operations, Development & Supply at The Look Company





# TECHNICAL SPECIFICATIONS & ORDER CODES

Model	L1810	L3214
<b>Laser Power</b>	50 or 100 Watt (Aircooled) 120 or 250 Watt (Watercooled)	250 Watt (Watercooled)
<b>Dimensions</b> <i>(H x W x D)</i>	1172 x 2810 x 2178 mm 1172 x 2810 x 2578 mm <i>(Base with Front Conveyor Extension)</i> 1632 x 2810 x 2178 mm <i>(Base with Vision System)</i> <i>All dimensions are displayed without Unwinder.</i>	2135 x 4382 x 3800 mm
<b>Media Width</b>	Up to 1845 mm	Up to 3400 mm
<b>Working Area</b>	1840 mm x 950 mm	3300 x 1400 mm
<b>Speed</b>	Up to 1000 mm/s	Up to 1500 mm/s
<b>Acceleration</b>	Up to 1 G	Up to 1 G
<b>Camera Recognition</b>	OPOS marks Optional: Vision System	OPOS marks Vision System
<b>Features</b>	Welded Steel base Three phase input Repeatability 0,05% of move or 0.05 mm (whichever is larger)	Extraction speed control Cageless bearings
<b>Standard Solution Includes</b>	Summa GoProduce Laser Edition Conveyor System (with configurable planks) Compressed air drying bowl and flow regulator Head Camera	PC and monitor GoProduce Laser Edition Conveyor system Vision system Chiller Air flow pumps Unwinder with edge detection
<b>Options</b>	Summa GoProduce Laser Edition Pro Pack Planks: Blade or Honeycombs Planks Front Conveyor Extension Unwinder Vision System	Summa GoProduce Laser Edition Pro Pack



L1810



L3214



# L SERIES™

---



## Advanced laser cutters for fabrics and textiles

Summa nv  
Rochesterlaan 6  
8470 Gistel  
Belgium

[www.Summa.com](http://www.Summa.com)

Summa America  
100 Cummings Center  
Suite #151-G  
Beverly MA 01915  
USA

Laser Division of Summa  
CadCam Technology Ltd.  
5 Crocus Street  
Nottingham / NG2 3DE  
United Kingdom

**Follow us on LinkedIn | Facebook | Twitter | YouTube | #SummaFinish**

---

Copyright 2022© Summa nv. Marketing Communications. Summa nv believes that all illustrations and specifications contained in this catalogue are correct at the time of publication. Summa nv reserves the right to make changes at any time, without notice. RevEN22.01 / All rights reserved