

# Operation Manual

## UV INKJET PRINTER *UCJV300 Series* *UCJV150 Series*

### Operation Manual

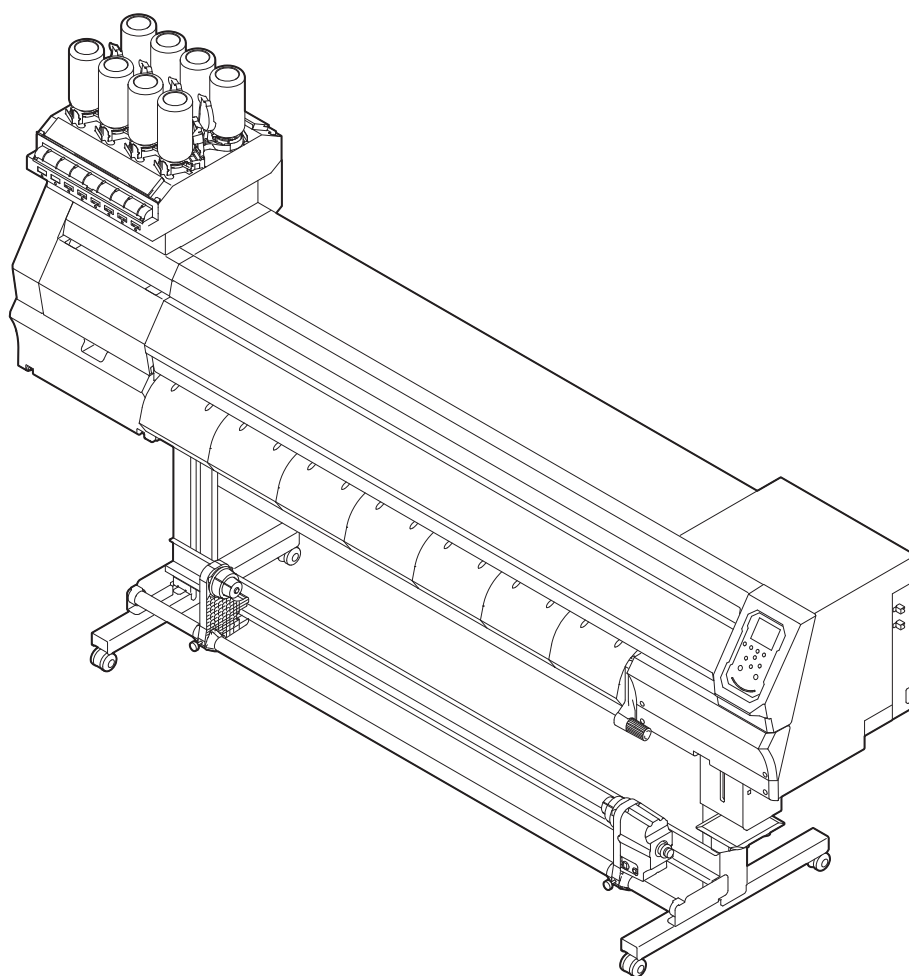

You can also download the latest manual from official website.

MIMAKI ENGINEERING CO., LTD.

<https://mimaki.com/>

D203176-29  
Original instructions

# TABLE OF CONTENTS

Introduction .....	6
To Ensure Safe Use .....	8
Symbols .....	8
Usage Precautions .....	9
Ink or any Other Liquid Used with the Machine .....	13
Ink Specifications .....	14
Restrictions Concerning the Machine .....	15
Installation Precautions.....	16
Installation Space .....	17
When Relocating This Machine .....	17
Moving This Machine.....	17
Safety Interlocks .....	19
Warning Label.....	20

## Chapter 1 Before Use

1.1 Part Names and Functions .....	24
Front .....	24
Rear and Right Side View.....	25
Carriage .....	26
Capping station.....	26
Pinch Rollers and Grit Rollers.....	26
Platen.....	27
Ink status lamp.....	27
Media Sensor.....	28
Power Supply Switch .....	28
Operating Panel.....	29
1.2 Connecting the Power Cable .....	33
Turning On the Power.....	33
Turning Off the Power.....	34
1.3 Connecting a PC to the Product .....	35
Using a USB Cable.....	35
Using a LAN Cable .....	35
1.4 System Configuration .....	37
Installing the Mimaki Driver.....	38
Installing RIP Software .....	38
Obtaining Color Profiles.....	38
Setting Up RIP Software.....	39
1.5 Ink Replacement Method.....	41
When Ink Near End is Displayed .....	41
When Ink End is Displayed.....	41
Replacing Ink .....	42

## Chapter 2 Printing

2.1 Print Process .....	50
2.2 Adjusting the Print Head Height.....	53

2.3 Adjusting the Pinch Roller Positions .....	54
1,600 mm Size .....	55
1,300 mm Size .....	56
1,070 mm Size .....	57
750 mm Size .....	58
2.4 Loading the Media .....	59
Media .....	59
Take-up unit .....	59
Loading the Roll Media .....	61
Setting Leaf Media .....	65
2.5 Setting the Pressure and Number of Pinch Rollers to Use .....	68
2.6 Test Printing .....	69
Changing the Layout Direction for Test Printing .....	69
Checking White Ink Ejection .....	69
Ejection Failures .....	70
2.7 Head Cleaning .....	71
2.8 Feed Correction .....	72
Feed Correction Procedure .....	72
2.9 Correcting the Drop Position .....	74
Drop Position Correction Procedure .....	74
2.10 Preparing RIP data .....	75
2.11 Printing .....	77
Changing the Origin .....	77
Starting Printing .....	77
Stopping Printing (Data Clear) .....	78
2.12 Cutting the media .....	79

## Chapter 3 Cutting

3.1 Cutting Process .....	82
3.2 Installing Cutting Tools .....	84
Using the Cutter .....	84
Using a Pen .....	88
3.3 Setting the Cutting Conditions .....	92
3.4 Test Cutting .....	93
3.5 Cutting the Cutting Data .....	94
Changing the Origin .....	94
Starting Cutting .....	94
Stopping Cutting (Data Clear) .....	95
Retracting the Cutter Unit .....	95

## Chapter 4 Cutting Data with Register Marks

4.1 Process for Cutting Data with Register Marks .....	98
--	----

4.2 Creating Register Marks .....	100
Register Marks.....	100
Register Mark Size .....	101
Spacing Between Register Marks.....	102
Reading Range of Register Marks.....	103
No-Plotting Areas Around Register Marks.....	104
Combined Operations of Printing and Cutting .....	104
4.3 Setting Mark Detection Conditions .....	105
4.4 Detecting the Position of the Register Mark Origin.....	106
4.5 ID Cut Process.....	107

## Chapter 5 Settings

5.1 Setup menu .....	110
Temporary Use .....	112
Changing the name of a setting type .....	113
LT mode.....	113
5.2 Maintenance Menu .....	115
Registering Nozzle Recovery .....	116
5.3 Machine setup menu .....	118
Event Email Function Settings.....	120
5.4 Nozzle check menu .....	123
5.5 Information menu.....	124
5.6 Cutting Menu .....	125
Copying the Last Data .....	128
Preventing Uncut Media .....	128

## Chapter 6 Maintenance

6.1 Maintenance Precautions .....	132
6.2 Maintenance Methods .....	133
Maintenance Items and Timing.....	133
Ink Maintenance .....	134
Wiper Cleaning .....	134
Cap Rubber Cleaning .....	136
NCU Cleaning.....	137
Carriage Underside Cleaning .....	138
Cleaning the Mist Filter .....	139
Ink Discharge Channel Cleaning .....	140
Media Sensor Cleaning .....	141
Media Holder Cleaning .....	142
Jam Sensor Cleaning .....	142
Platen Cleaning .....	143
Cover (Exterior) Cleaning .....	144
When this printer is left unused for a long time.....	144

6.3 Consumable Item Replacement .....	147
Wiper Replacement .....	147
Cap Absorber Replacement .....	148
Mist Filter Replacement .....	149
LED Glass Replacement .....	150
Exhaust Fan Filter Replacement .....	151
Pinch Roller Replacement .....	152
Media Holder Replacement .....	153
Media Cutter Replacement .....	155
Waste Ink Tank Replacement.....	156
About the Media Cutter .....	159
Pen Line Replacement .....	160

## Chapter 7 Troubleshooting

7.1 Troubleshooting .....	162
The power does not turn on.....	162
Printing is not possible.....	162
The media jams or the media is dirty.....	162
Image Defects Occur.....	163
The ink has leaked out.....	168
The light-blocking cover comes off.....	168
Cutting Related .....	168
7.2 Problems Causing Messages to Appear .....	174
Warning Messages .....	174
Ink Errors .....	176
Error Message .....	177
SYSTEM HALT .....	183

## Chapter 8 Appendix

8.1 Specifications.....	186
8.2 Specifications (Cutting).....	189
8.3 LICENSE Library .....	190

# Introduction

Thank you for purchasing the UV-LED curable inkjet printer UCJV300 Series, 150 Series.

Read this operating manual ("this document" hereinafter) thoroughly and make sure you understand its contents to ensure safe and correct use of the product.

Please note that the illustrations contained in this manual are intended to show functions, procedures, or operations and may sometimes differ slightly from the actual machine.

Adobe, the Adobe logo, Acrobat, Illustrator, Photoshop, and PostScript are the trademarks or registered trademarks of Adobe Incorporated in the United States and other countries.

RasterLink is a trademark or a registered trademark of Mimaki Engineering Co. Ltd. in Japan and other countries.

Other company and product names mentioned herein are the trademarks or registered trademarks of the respective companies in Japan and in other countries.

Unauthorized reproduction of any portion of this document is strictly prohibited.

© 2017 MIMAKI ENGINEERING Co., Ltd.

## ● DISCLAIMERS

- MIMAKI ENGINEERING REJECTS ALL LIABILITY FOR DAMAGE ARISING DIRECTLY OR INDIRECTLY FROM THE USE OF THE UCJV300 Series, 150 Series ("THIS MACHINE" HEREINAFTER), WHETHER OR NOT THE PRODUCT IS FAULTY.
- MIMAKI ENGINEERING REJECTS ALL LIABILITY FOR DAMAGE, DIRECT OR INDIRECT, TO MATERIALS CREATED WHILE USING THIS MACHINE.
- USING THIS MACHINE IN CONJUNCTION WITH DEVICES OTHER THAN THOSE RECOMMENDED BY MIMAKI ENGINEERING MAY RESULT IN FIRE OR ACCIDENTS. SUCH INCIDENTS ARE NOT COVERED BY THE PRODUCT WARRANTY. MIMAKI ENGINEERING REJECTS ALL LIABILITY FOR DAMAGE, DIRECT OR INDIRECT, ARISING FROM SUCH INCIDENTS.
- USE ONLY GENUINE MIMAKI ENGINEERING INK AND MAINTENANCE LIQUID. USE OF OTHER PRODUCTS MAY RESULT IN FAILURES OR REDUCE PRINT QUALITY. SUCH INCIDENTS ARE NOT COVERED BY THE PRODUCT WARRANTY. MIMAKI ENGINEERING REJECTS ALL LIABILITY FOR DAMAGE, DIRECT OR INDIRECT, ARISING FROM SUCH INCIDENTS.
- DO NOT ATTEMPT TO REFILL THE INK BOTTLES WITH UNAUTHORIZED INK. SUCH INCIDENTS ARE NOT COVERED BY THE PRODUCT WARRANTY. MIMAKI ENGINEERING REJECTS ALL LIABILITY FOR DAMAGES, DIRECT OR INDIRECT, ARISING FROM SUCH INCIDENTS.
- USE ONLY GENUINE MIMAKI ENGINEERING ANTI FREEZING LIQUID. USE OF OTHER ANTI FREEZING LIQUID MAY CAUSE FAILURES OR REDUCE PRINT QUALITY. SUCH INCIDENTS ARE NOT COVERED BY THE PRODUCT WARRANTY. MIMAKI ENGINEERING REJECTS ALL LIABILITY FOR DAMAGES, DIRECT OR INDIRECT, ARISING FROM SUCH INCIDENTS.
- AVOID USING UV-LED UNITS OR UV POWER SUPPLY UNITS OTHER THAN THOSE SPECIFIED BY MIMAKI ENGINEERING. USING DEVICES OTHER THAN GENUINE MIMAKI ENGINEERING DEVICES MAY RESULT IN FAILURE, ELECTRIC SHOCK, OR FIRE. SUCH INCIDENTS ARE NOT COVERED BY THE PRODUCT WARRANTY. MIMAKI ENGINEERING REJECTS ALL LIABILITY FOR DAMAGES, DIRECT OR INDIRECT, ARISING FROM SUCH INCIDENTS.

## ● TV and radio interference



- The machine emits high-frequency electromagnetic radiation while operating. Under certain circumstances, this may result in TV or radio interference. We make no guarantee that this machine will not affect special radio or TV equipment.

If radio or TV interference occurs, check the radio or TV reception after turning off the machine. If the interference disappears when the power is turned off, the machine is likely to be the cause of the interference.

Try any of the following solutions or combinations of these solutions:

- Change the orientation of the TV or radio antenna to find a position where interference does not occur.

- Move the TV or radio away from this machine.
- Plug the TV or radio into a power outlet on a power circuit other than the power circuit to which this machine is connected.

### ● FCC (Federal Communications Commission) regulations

The machine has been tested and certified to comply with restrictions applying to Class A digital devices under Part 15 of the FCC regulations. These restrictions are designed to provide suitable protection from harmful interference when the printer is used in commercial environments.

This product may generate, use, or emit radio frequency energy and may cause harmful interference with radio communications if not installed or used in accordance with the operating manual.

Use of this product in residential areas may cause harmful interference. If so, the user is responsible for rectifying such interference.











- Use only the cables recommended by Mimaki Engineering when connecting to the machine. Use of other cables may cause the product to exceed the restrictions stipulated by FCC regulations. To maintain compliance with FCC regulations, use the cables recommended by Mimaki Engineering.
-

# To Ensure Safe Use

## Symbols

In this manual, the symbols indicate and explain precautions. Make sure you fully understand the meaning of each symbol and use the machine safely and correctly.

Explanation		
	Warning	Indicates a potential hazard that may result in death or serious injury if handled improperly or if instructions are disregarded.
	Caution	Indicates a potential hazard that may result in minor or moderate injury if handled improperly or if instructions are disregarded.
	Notice	Indicates a potential hazard that may result in property damage if handled improperly or if instructions are disregarded.
	Warning sign	Indicates something that requires attention. Warning specifics are drawn inside the symbol.
	Mandatory action sign	Indicates an action that must be carried out. The specifics of the mandatory action are drawn inside the symbol.
	Prohibition sign	Indicates a prohibited action. The specifics of the prohibited action are drawn inside the symbol.
	Important	Indicates important information related to use of this machine.
	Tip	Indicates useful reference information.
	Reference information	Indicates the corresponding page for related information.



## Usage Precautions

### ● In the event of abnormal conditions

#### WARNING



- In the event of abnormal conditions such as smoke or unusual odor, turn off the main power immediately and unplug the power cable. Continuing to use the product under these conditions may result in failure, electric shock, or fire. Once you have confirmed that smoke is no longer being emitted, contact your local dealer or our service office. Never attempt to repair the product yourself. Doing so is hazardous.

#### CAUTION



- Immediately wipe off any ink, maintenance liquid, waste ink, or other liquid used with the product that comes into contact with your skin. Then wash using soap, and rinse with plenty of water. Failure to wash off ink may result in skin inflammation. If your skin becomes irritated or painful, seek medical attention immediately.
- If ink, maintenance liquid, waste ink, or any other liquid used in the product comes into contact with your eyes, rinse immediately with plenty of clean water. Rinse for at least 15 minutes. If you wear contact lenses and they can be easily removed, remove after rinsing for at least 15 minutes with clean water. Be sure to also rinse the undersides of your eyelids. Failure to rinse off ink may result in blindness or impaired vision. If your eyes become irritated or painful, seek medical attention immediately.
- If ink, maintenance liquid, waste ink, or any other liquid used in the product enters your mouth or is swallowed, gargle with water immediately. Do not induce vomiting. Seek medical attention promptly. Inducing vomiting may cause liquid to enter the airway.
- If a large amount of vapor is inhaled, move to a well-ventilated area, keep warm, and rest in a posture that allows easy breathing. If the condition does not improve, seek medical attention promptly.

#### NOTICE



- If an ink leak occurs, turn off the main power immediately and unplug the power cable. Then, contact your local dealer or our service office.

## ● Power supply precautions

### ⚠ WARNING



- Use the power cable provided. Otherwise there is a risk of failure, electric shock, or fire. Do not use the power cable with other electronic devices.
- Always grasp the plug when unplugging the power cable. Pulling on the power cable itself may damage the cable and result in failure, electric shock, or fire.
- Do not use the power plug with dust on it. Otherwise there is a risk of failure, electric shock, or fire.
- Avoid touching the blade of the power plug with a metal object. Otherwise there is a risk of failure, electric shock, or fire.
- Do not attempt to modify the cable. Avoid damaging the cable. Avoid placing heavy objects on the power cable or pulling on or exposing the cable to heat. Doing so may damage the cable, resulting in electric shock or fire.
- Do not use extension cords or multi-outlet extension cords. Otherwise there is a risk of failure, electric shock, or fire.
- Do not use if the power cable appears to be damaged or the core wire has an exposed or broken core. Otherwise there is a risk of failure, electric shock, or fire.



- Do not handle the power plug with wet hands. Disregarding this precaution may result in electric shock.



- Plug the power cable plug into a grounded power outlet. Otherwise there is a risk of failure, electric shock, or fire.
- When installing electrical outlets, perform grounding work to prevent electric shock. All electrical work (Class C grounding work; formerly Type 3 grounding work) must be handled by a licensed electrician.

### NOTICE



- Do not turn off the main power supply. Turning off the main power supply will disable the automatic maintenance function (including nozzle clogging prevention function and waste ink draining channel cleaning function). This will increase the risk of print defects (e.g., nozzle clogging, deflection).

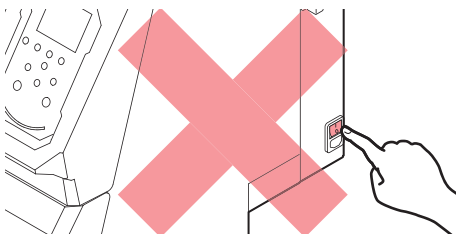

- Use the machine with a power supply that meets specifications.
- Be sure to plug the power cable into a power outlet close to the machine. Insert the power plug blade securely.
- When connecting the power cable, check the input voltage of the power outlet and the capacity of the breaker. Also, connect each cable to a separate power source with an independent breaker. Connecting to power outlets linked to the same breaker may cause the breaker to trip.

## ● Caution regarding moving parts

### CAUTION



- Keep parts of the body such as the face and hands away from moving parts. Also keep clothing (e.g., loose clothing and accessories) that may impede work away from the machine. Failure to do so may result in injury.



- Long hair should be tied back. Failure to do so may result in injury.

## ● Do not disassemble or repair

### WARNING



- Do not attempt to disassemble or repair this machine. Otherwise there is a risk of failure, electric shock, or fire.

## ● Handling the cutter

### CAUTION



- Avoid touching the cutter blade. Failure to do so may result in injury.
- Do not shake or swing the cutter holder. Doing so may cause the blade to come off.

## ● Ultraviolet light (UV) and the UV-LED unit

### WARNING



- Do not place combustible materials underneath UV-LED unit or cover the UV-LED unit with paper or cloth. Disregarding this precaution may result in fire or smoldering.



- Small amounts of ultraviolet light may leak from the UV-LED unit. Wear UV safety glasses, face shields, masks, gloves, and long-sleeved clothing to protect the eyes and skin from ultraviolet light.
  - (1) Exposure to ultraviolet light may result in skin inflammation. Even if no inflammation occurs, extended or repeated exposure may lead to chronic problems.
    - Acute problems: Inflammation
    - Chronic problems: Skin cancer, wrinkles, blotches
  - (2) Looking directly at the lamp while the lamp is on may result in eye pain or damage to eyesight. Even if no eye pain occurs, extended or repeated exposure may lead to chronic problems.
    - Acute problems: Ultraviolet keratitis, conjunctivitis, discomfort, pain, watery eyes
    - Chronic problems: Pterygium, cataracts

### CAUTION



- The UV-LED unit becomes extremely hot. Be careful not to touch the LED after it has been turned off until it has sufficiently cooled.



- Do not expose the skin or eyes directly or indirectly to light from the UV-LED unit. The UV-LED unit emits ultraviolet (UV) light. Skin or eye exposure may result in inflammation.



- Be sure to use the UV safety glasses provided. Disregarding this precaution may result in eye pain or damage to eyesight.

**NOTICE**



- Avoid scratching or subjecting the UV-LED unit to excessive force. Disregarding this precaution may result in deformation or failure of the unit.
- Avoid touching the glass on the underside of the UV-LED unit with bare hands. Disregarding this precaution may impair UV ink curing. If the glass becomes dirty, wipe clean using a soft, clean cloth soaked with ethanol. Be careful to keep ethanol from splashing on the covers or other parts while cleaning. Disregarding this precaution may result in deformation or failure of the unit.

● **Other usage precautions**

**WARNING**



- Keep children away from this machine.

**NOTICE**



- Do not pull the media when the clamp lever is lowered (the media is clamped). Doing so may damage the machine.



- The underside of the media may be soiled depending on how the printed media has been stored (due to weight when laying printed media rolls horizontally, for example) and the media type. Perform a test beforehand to check that the media does not transfer ink to the underside of the adjacent media.

● **Disposing of the product**

**CAUTION**



- Please contact your local retailer or service agent.
- When disposing of the product yourself, contact an industrial waste disposal operator or dispose of the product in accordance with local laws and regulations.

# Ink or any Other Liquid Used with the Machine

Precautions regarding ink, maintenance liquid, or other liquids used with this machine are included with the containers. Thoroughly read them and make sure you understand the contents.

## WARNING



- Take steps to prevent leakage into natural water systems or domestic wastewater. Some constituents are toxic to aquatic life.

## CAUTION



- Be sure to read the safety data sheet (SDS) before use. <https://mimaki.com/supply/sds/>



- Pay close attention to ventilation and be sure to wear safety glasses, gloves, and a mask when handling ink, maintenance liquid, waste ink, or other solutions used with the machine. Leaking ink may adhere to the skin or get into the eyes or mouth.



- Use only genuine Mimaki Engineering anti freezing liquid. Use of other anti freezing liquid may cause failures of the cooling unit.
- Take care to prevent any potential sources of ignition such as sparks caused by static electricity or material impacts.
- Be sure to dispose of any unneeded anti freezing liquid in the following manner.
  - (1) Soak it up with materials such as sawdust or rags and burn them in an incinerator.
  - (2) Pass them onto a licensed industrial waste disposal company after clearly indicating their contents.



- Do not subject the Ink bottle to strong shocks or violent shaking. Do not attempt to refill the ink. Leaking ink may adhere to the skin or get into your eyes or mouth.



- Do not disassemble the Ink bottle. Leaking ink may adhere to the skin or get into your eyes or mouth.



- Avoid storing this product in locations accessible to children.



- When disposing of the product, contact an industrial waste disposal operator or dispose of the product in accordance with the local laws and regulations.

## NOTICE



- Do not use ink, maintenance liquid, or other liquids used with this machine with other printers. Doing so may damage the machine.
- Do not touch the metal parts of the ink IC chip. Static electricity may damage the ink IC chip, and dirt or damage may make the ink IC chip unreadable.



- Store in a low place no higher than 1 m above the floor. Dropping this machine may result in splashing ink.
- Store in sealed containers.
- Store in a cool and dark place.
  - (1) Store ink in an environment where it will not freeze. Note that using thawed ink may affect printing quality due to ink degradation.
  - (2) When moving ink from cold to warm locations, allow to stand for at least three hours before use in the same conditions as the machine.
  - (3) Open the ink before use and use up as quickly as possible. Print quality may degrade if the bottles are left open for extended periods.



- Printing is not possible when different types of ink IC chips are used.
- If the ink bottle mounted on the machine is dented, it may still be used.

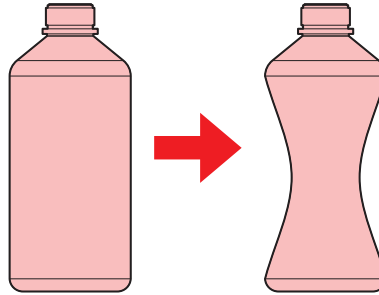

- Do not store ink, maintenance liquid, or other liquids used with the machine in locations exposed to direct sunlight.
- Do not store ink, maintenance liquid, or other liquids used with the machine in environments where cutting fluid or other volatile substances (such as amines or modified amine alcohol) are present in significant quantities. Storage in such places increases the risk of failure or ejection failures (e.g., nozzle clogging or deflection).

## Ink Specifications

Item		Details
Type		UV curing ink (MIMAKI product)
Color		Cyan (C) Magenta (M) Yellow (Y) Black (K) Light cyan (Lc) <sup>*1</sup> Light magenta (Lm) <sup>*1</sup> White (W) <sup>*1</sup> Clear ink (CL) <sup>*1</sup>
Form		Bottle
Ink capacity		1,000 ml
Expiration date		As indicated on the ink bottle However, within three months after opening, even before the expiration date
Storage temperature	When stored	5 °C to 30 °C (daily mean temperature) However, not more than 1 month at 30 °C <ul style="list-style-type: none"> <li>• Ink quality may deteriorate if stored outside these conditions.</li> </ul>

Item		Details
	During transportation	1 °C to 60 °C However, not more than 120 hours at 60 °C, and not more than 1 month at 40 °C <ul style="list-style-type: none"> <li>• Where possible, avoid storing in cold locations below 0 °C and hot locations above 40 °C.</li> <li>• Ink quality may deteriorate if stored outside these conditions.</li> </ul>

\*1. 300 series only

## Restrictions Concerning the Machine

The ink expiration date is indicated on the Ink bottle. Expired ink may cause ejection failures or alter the color tone. Printing is possible even if the ink has passed its expiration date. Nevertheless, we recommend replacing with new ink or using up as quickly as possible.

Example: When the expiration date is April 20xx

- May 20xx: Replace with new ink or use up as quickly as possible. Printing is possible.
- June 20xx: Replace with new ink or use up as quickly as possible. Printing is possible.
- July 20xx: Printing is not possible.



- The message appears on the display.

# Installation Precautions

## WARNING



- Do not install this machine in environments where flammable substances are present (e.g., gasoline, flammable spray, alcohol, thinner, lacquer, or powder). This machine is not explosion-proof. The product poses a risk of explosion.



- Do not install this machine in locations where open flames are present. The ink may ignite.
- Do not place vases, pot plants, cups, cosmetics, containers of chemicals or water, or small metal objects on top of this machine. There is a risk of failure, electric shock, or fire if liquids or items drop inside the machine.



- Do not install this machine in humid locations or locations where it may be exposed to splashing water. Otherwise there is a risk of failure, electric shock, or fire.



- Avoid installing this machine in locations accessible to children.

## CAUTION



- A ventilation system must be provided if this machine is installed in a poorly ventilated area or sealed room.
- Be sure to observe the following points when installing an extractor outlet:
  - (1) The extractor outlet must be installed in accordance with applicable local EHS (environmental, health, and safety) guidelines.
  - (2) If the extractor outlet is fitted with a shutoff valve, the valve must be open when this machine is in use.

## NOTICE



- Do not install this machine in locations where dust or powder is present. Failure or printing defects may result (e.g., nozzle clogging, deflection) if dust gets inside this machine.
- Do not install this machine in locations exposed to drafts (e.g., from air conditioning). Disregarding this precaution may result in dust or powder getting inside this machine.
- Do not install this machine in unstable locations or locations subject to vibration. This will increase the risk of failure or printing defects (e.g., nozzle clogging, deflection).
- Do not install this machine in locations exposed to direct sunlight.
- Do not install this machine in locations subject to sudden temperature changes. This will increase the risk of failure or printing defects (e.g., nozzle clogging, deflection).
- Do not install this machine in locations exposed to excessive noise from large machinery.
- Do not install this machine in locations where photographic fixing agents generate vapor or acid gas (e.g., acetic acid, hydrochloric acid) or locations filled with metal working fluids or highly volatile substances (e.g., amines, amine-modified alcohols). Malfunctions or printing defects may result (e.g., nozzle clogging, deflection) as print head ink is more likely to harden under such environments.



- Operating conditions: 20 °C to 30 °C (68 °F to 86 °F), 35 %RH to 65 %RH (no condensation)
- Guaranteed accuracy temperature range: 20 °C to 25 °C (68 °F to 77 °F)



## Installation Space

Provide the following space around the machine to allow safe and proper replacement of ink and media:

Item	UCJV300-160	UCJV300-130	UCJV300-107	UCJV300-75	UCJV150-160
Width <sup>*1</sup>	At least 3,900 mm (2,900 mm)	At least 3,650 mm (2,650 mm)	At least 3,380 mm (2,380 mm)	At least 3,090 mm (2,090 mm)	At least 3,900 mm (2,900 mm)
Depth <sup>*1</sup>	At least 2,776 mm (776 mm)				
Height <sup>*1, *2</sup>	(1,475 mm)				
Weight	188 kg	177 kg	161 kg	144 kg	183 kg

\*1. The figures in parentheses indicate machine dimensions.

\*2. Excluding ink bottle height

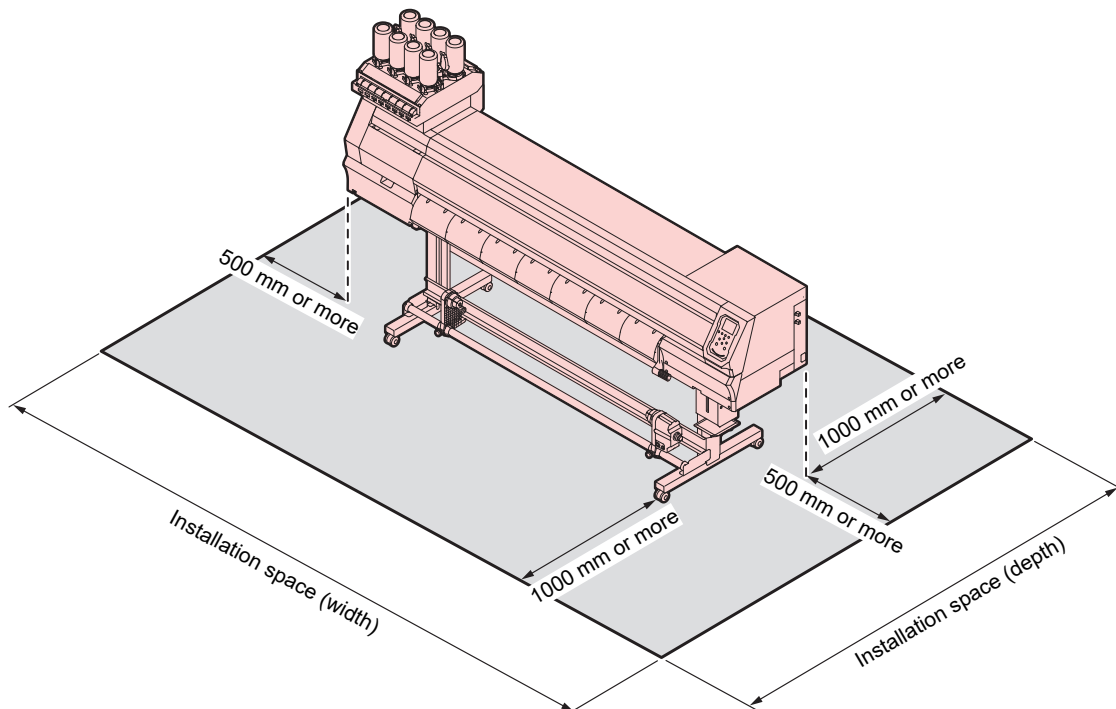

## When Relocating This Machine

Contact your local dealer or our service office. Attempting to handle relocation yourself may result in failure or damage.

## Moving This Machine

Never move this machine. If circumstances make it unavoidable, move the machine only to a location somewhere on the same floor horizontally.



- Read and make sure you fully understand the procedures before moving this machine.



- Do not move by pushing the cover. Otherwise the cover may be damaged.

**1** Attach the transportation stays fitted underneath this machine.

**2** Remove the caster block.

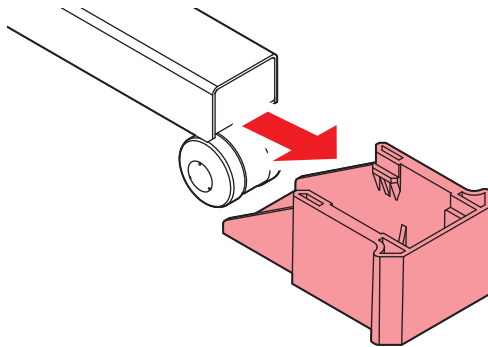

**3** Move by grasping the transportation stays.

- Assign at least six persons to move this machine. Comply with local regulations when moving the product.

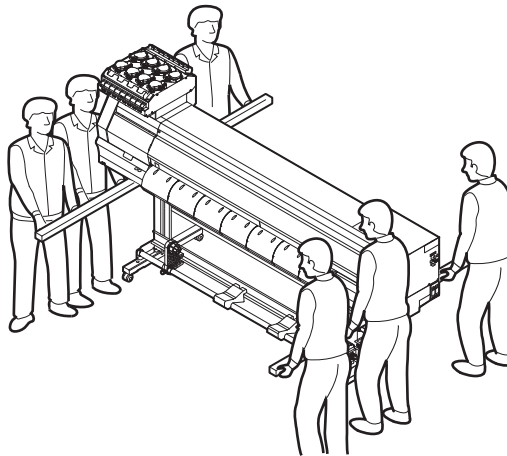

**4** Replace the caster block.

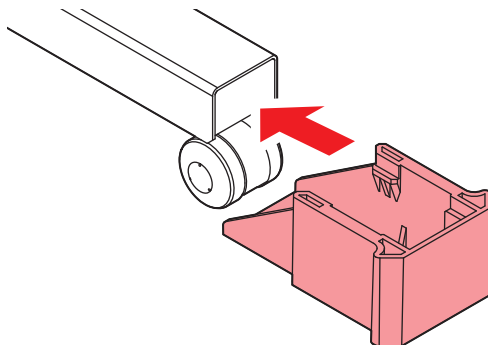

**5** Remove the transportation stays.

**6** Attach the transport stay to the underside of the main unit.

**7** Check to confirm the nozzle is not clogged.

**8** Be sure to correct the feed and the dot position before printing.

# Safety Interlocks

The machine is equipped with interlocks to ensure safety during use.

Printing will abort if you open the covers while printing is underway. The RIP data will need to be resent.

- Safety interlock locations

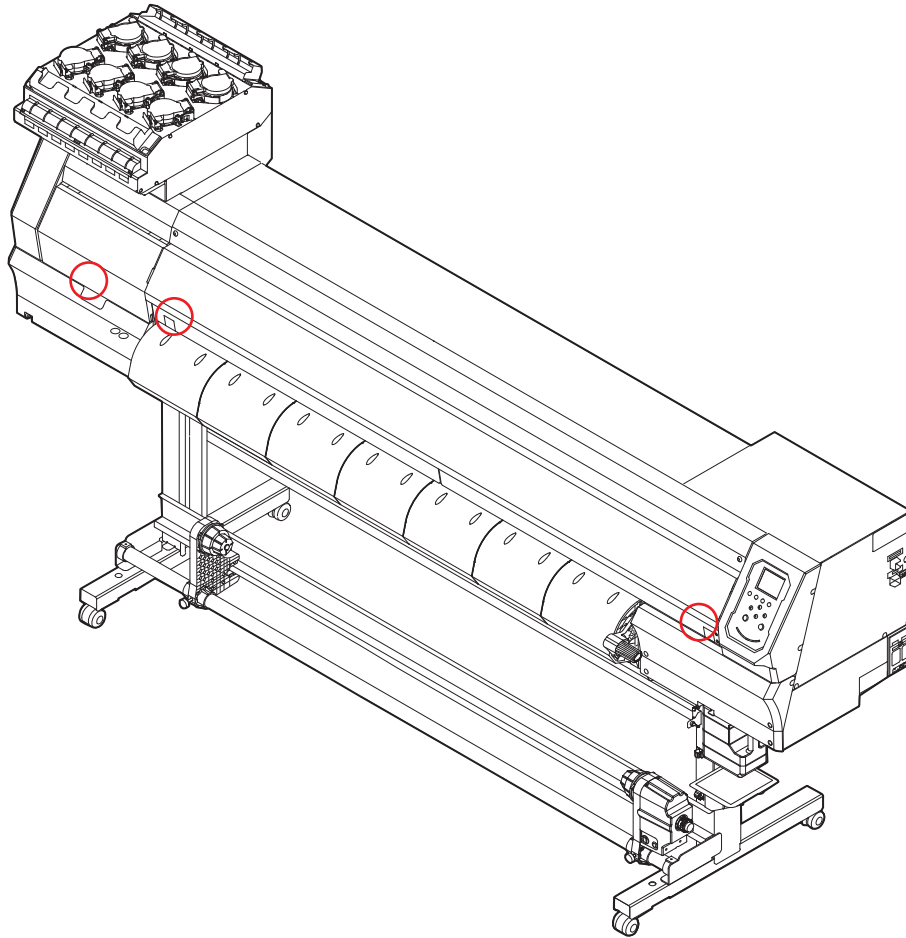





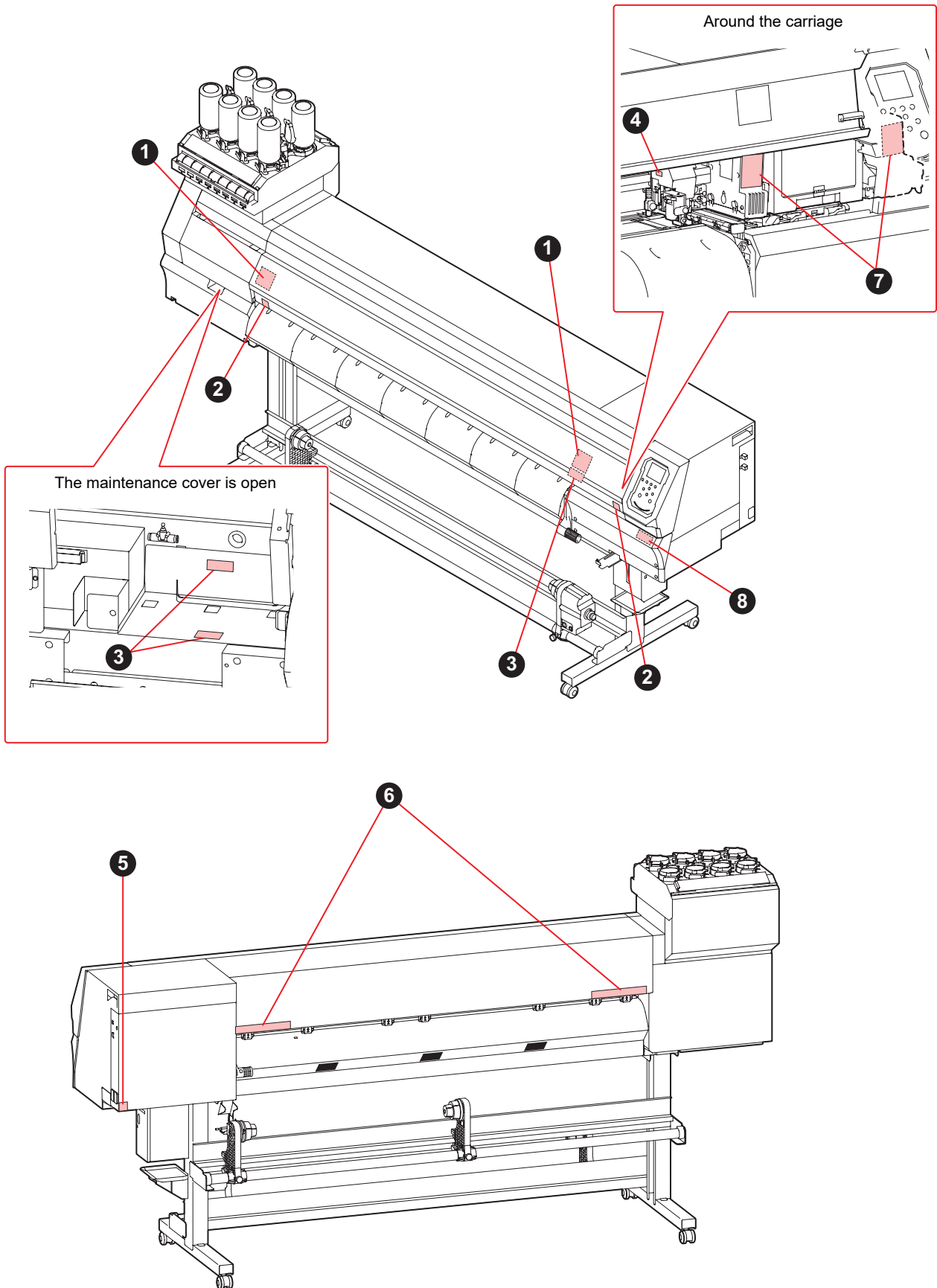

# Warning Label

Make sure you fully understand the details indicated on the various warning labels.

If any of the warning labels becomes dirty and illegible or peel off, contact your local dealer or our service office to request new warning labels.

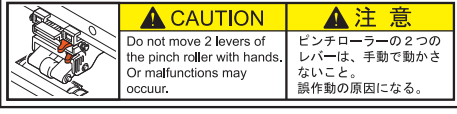

No.	Order code	Label	Details
1	M910931	 <p><b>CAUTION</b> <b>ATTENTION</b></p> <p><b>COVER HAZARD</b> May result in severe injury. When open and close the cover, hold a cover until the end.</p> <p><b>COUVERCLE-DANGER</b> Peut entraîner de graves blessures. Lors de l'ouverture ou de la fermeture du couvercle, tenir le couvercle jusqu'à la fin.</p> <p>カバー急落下あり 指を挟まると、ケガや骨折の恐れあり。 カバーの開閉は、最後まで手を添えて行ってください。</p> <p>M910931</p>	Beware of opening and closing parts. Injury may result if hands become trapped.
2	M907833		Indicates dangerous moving parts.
3	M903330		Wear safety glasses and gloves while working.
4	M903405		Beware of the cutter.
5	M907935		Indicates dangerous live parts.
6	M905811	 <p><b>警告</b> <b>警告</b> <b>WARNING</b> <b>WARNSCHÜNING</b> <b>AVERTISSEMENT</b></p> <p>手指や身体部分の動きが速い部分。注意してください。 危険な動き HÄNDEN UND ANDERE KÖRPERTEILE WEGHALTEN Keep fingers and other body parts away. GEFÄHRLICHE BEWEGLICHE TEILE Finger und andere Körperteile fernhalten. Pièces mobiles en mouvement. DANGER DE BLESSURE Les doigts et autres parties du corps sont hors du pontet.</p>	Indicates dangerous moving parts.
7	M913419	 <p><b>WARNING</b> <b>AVERTISSEMENT</b> 警告</p> <p><b>ULTRAVIOLET RADIATION</b> <b>RAYONS ULTRAVIOLETS</b> 紫外線注意 紫外線照射</p> <p>Ultraviolet Radiation, When exposed to ultraviolet light, there is a risk of blindness or burns. Rayonnement UV-Violet. Exposition dangereuse pour l'œil et la peau. Peut provoquer la cécité et des brûlures. 紫外線が照射されています。紫外線を浴びると失明や火傷の恐れがあります。 紫外線照射注意 紫外線照射による失明 視覚障害の原因</p>	Beware of ultraviolet light.
8	M905935	 <p><b>CAUTION</b> <b>注意</b></p> <p>Do not move 2 levers of the pinch roller with hands. Or malfunctions may occur.</p> <p>ピンチローラーの2つのレバーは、手で動かさないこと。誤作動の原因になる。</p>	Avoid touching the pinch roller lever.

# Chapter 1 Before Use



## This chapter

This chapter describes information essential before use, such as part names.

Part Names and Functions .....	24	Connecting a PC to the Product .....	35
Front .....	24	Using a USB Cable .....	35
Rear and Right Side View .....	25	Using a LAN Cable .....	35
Carriage .....	26	System Configuration .....	37
Capping station .....	26	Installing the Mimaki Driver .....	38
Pinch Rollers and Grit Rollers .....	26	Installing RIP Software .....	38
Platen .....	27	Obtaining Color Profiles .....	38
Ink status lamp .....	27	Setting Up RIP Software .....	39
Media Sensor .....	28	Ink Replacement Method .....	41
Power Supply Switch .....	28	When Ink Near End is Displayed .....	41
Operating Panel .....	29	When Ink End is Displayed .....	41
Connecting the Power Cable .....	33	Replacing Ink .....	42
Turning On the Power .....	33		
Turning Off the Power .....	34		

# 1.1 Part Names and Functions

## Front

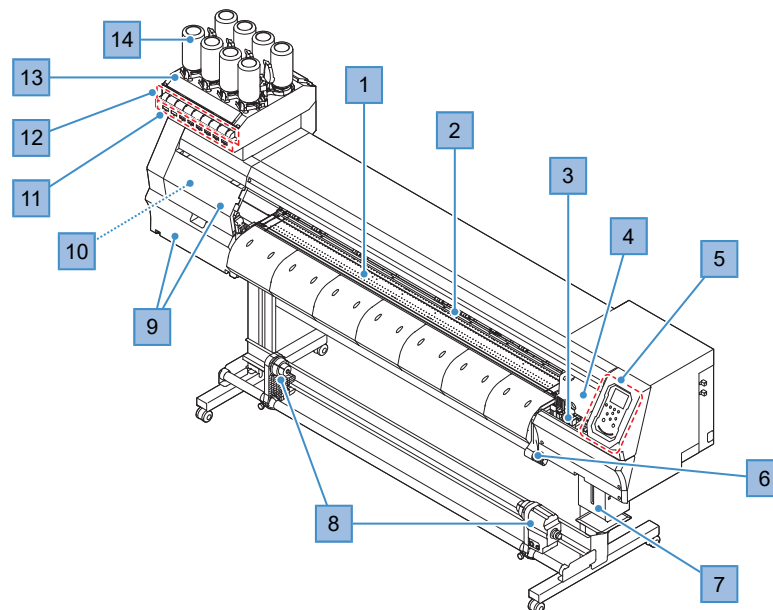

No.	Name	Overview
1	Platen	Print area. <a href="#">"Platen"(P. 27)</a>
2	Pinch roller Grit rollers	The pinch rollers and grit rollers are used to grip and feed the media. <a href="#">"Pinch Rollers and Grit Rollers"(P. 26)</a>
3	Capping station	Includes caps, wipers, and an NCU for monitoring print head nozzle conditions. <a href="#">"Capping station"(P. 26)</a>
4	Carriage	Consists of a print head, a UV-LED lamp, and the jam sensor. <a href="#">"Carriage"(P. 26)</a>
5	Operating panel	Includes operating keys and displays indicating various settings and other items. <a href="#">"Operating Panel"(P. 29)</a>
6	Clamp lever (front)	Lowering the clamp lever secures the media. Raising the clamp lever releases the media.
7	Waste ink tank	Container for waste ink. <a href="#">"Waste Ink Tank Replacement"(P. 156)</a>
8	Take-up unit	Rolls up the printed roll media. <a href="#">"Take-up unit"(P. 59)</a>
9	Maintenance cover	Open the cover to perform maintenance on the carriage underside. Printing and automatic maintenance are not possible while the covers are open.
10	Cutter unit	Includes a media cutter cutting the media along the platen cutting slot. The cutter unit is located at the maintenance position on the left side during standby. <a href="#">"Installing Cutting Tools"(P. 84)</a>
11	Ink IC chip slot	The IC chip provided with the Ink bottle is inserted here. This manages information on the Ink bottle. Insert Ink IC Chip
12	Ink status lamp	This lamp indicates ink status. <a href="#">"Ink status lamp"(P. 27)</a>
13	Ink wipe filter	Filter for soaking up ink droplets from the ink bottle special caps.
14	Ink supply unit	The ink bottle is inserted here to supply ink to the print head. <a href="#">"Ink Replacement Method"(P. 41)</a>



## Rear and Right Side View

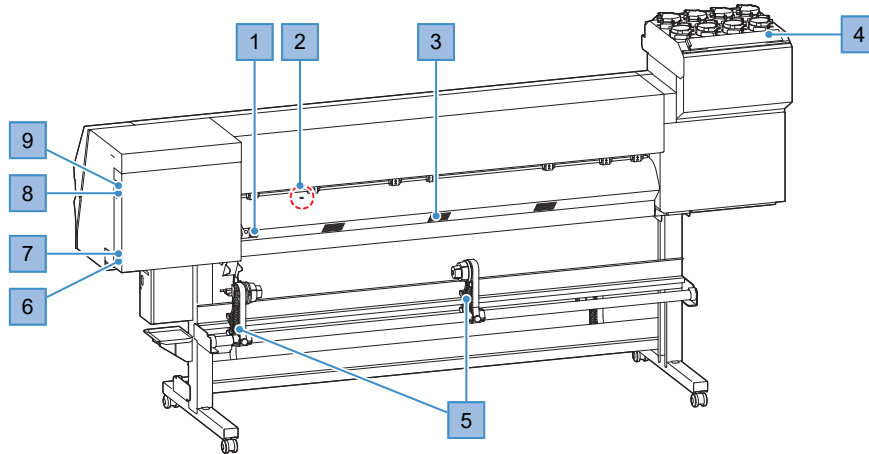

No.	Name	Overview
1	Clamp lever (rear)	Linked to the clamp lever at the front.
2	Media sensor	Detects whether media is present. <a href="#">"Media Sensor"(P. 28)</a>
3	Media vacuum exhaust port	Vacuum exhaust port securing media under vacuum pressure
4	Ink wipe filter	Filter for soaking up ink droplets from the ink bottle special caps.
5	Feed unit	Holds the roll media before printing. Compatible with 2-inch and 3-inch paper rolls
6	AC inlet	Used to connect the power cable (provided). <a href="#">"Connecting the Power Cable"(P. 33)</a>
7	Main power switch	Main power supply for the product To prevent print defects attributable to the print head (e.g., nozzle clogging, deflection), do not turn off the main power supply. <a href="#">"Turning On the Power"(P. 33)</a> <a href="#">"Turning Off the Power"(P. 34)</a>
8	LAN port	Used when using the network function. <a href="#">"Using a LAN Cable"(P. 35)</a>
9	USB port	Connects to PC via a USB interface cable. <a href="#">"Using a USB Cable"(P. 35)</a>

## Carriage

The carriage includes a print head for ejecting ink, a UV-LED lamp for curing UV ink, and a jam sensor for stopping the carriage when media clogs. Printing occurs as ink is ejected while traversing left and right.

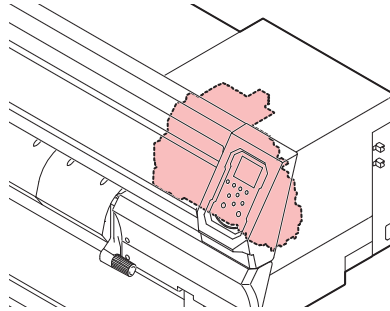

- Be sure to use the UV safety glasses provided. Disregarding this precaution may result in eye pain or damage to eyesight.

## Capping station

The capping station includes caps for keeping the print head nozzle surface from drying out, a wiper required for print head maintenance, and an NCU for monitoring print head nozzle conditions.

The NCU (Nozzle Check Unit) automatically checks whether the nozzle is clogged. Setting various functions enables automatic print head cleaning or printing using other nozzles. (👉 "[Nozzle check menu](#)"(P. 123) 👈) ("[Registering Nozzle Recovery](#)"(P. 116))

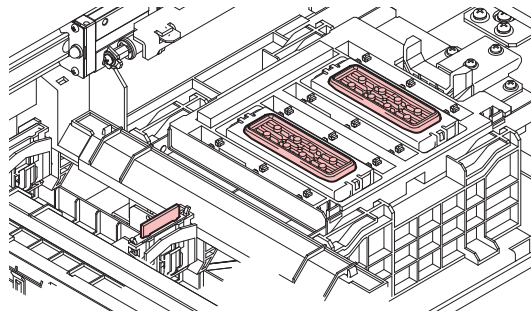

## Pinch Rollers and Grit Rollers

The pinch rollers and grit rollers are used to grip and feed the media.

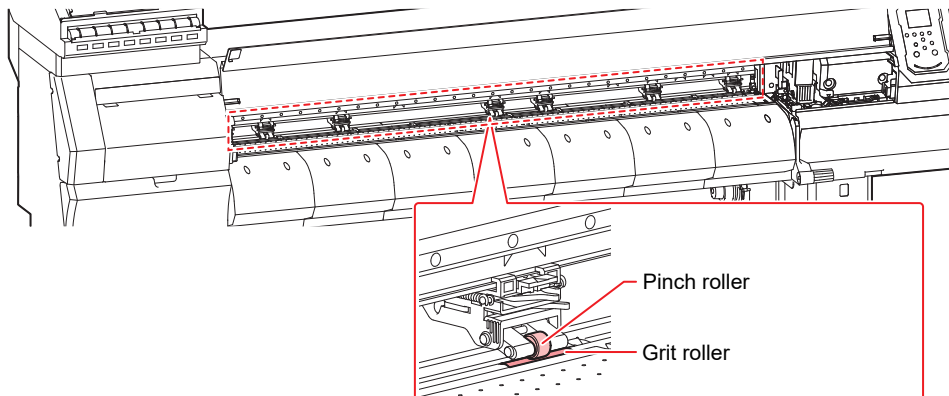



- When the machine is not in use, raise the clamp lever to separate the pinch rollers from the grit rollers. Leaving the pinch rollers in the lowered position for an extended period of time may cause the pinch rollers to become deformed. Deformation of the pinch rollers may prevent the media from being fed correctly.

## Platen

The platen features a large number of holes used to secure the media under vacuum pressure. This also features a cutting slot for cutting the media.

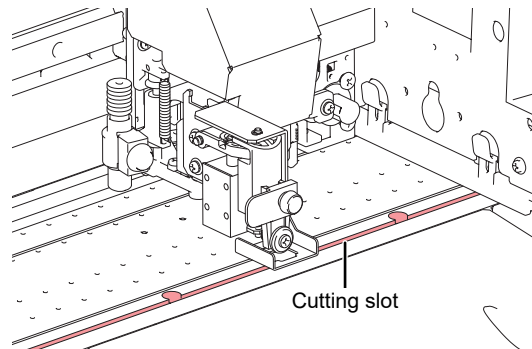

## Ink status lamp

You can check the status of the ink by looking at the lamp on the ink supply unit.

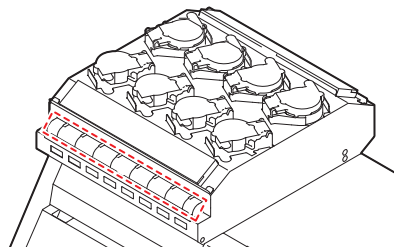

Color	Status	Overview
-	Off	No error
Blue	Illuminated	Ink is being supplied (no error)
Yellow	Illuminated Flashing	One of the following errors has occurred: Printing is possible. <ul style="list-style-type: none"> <li>• INK NEAR END</li> <li>• Ink has expired (1 months passed)</li> </ul>
Red	Illuminated	One of the following errors has occurred: Printing is not possible. <ul style="list-style-type: none"> <li>• INK END</li> <li>• The ink IC chip is not inserted.</li> <li>• Other ink errors</li> </ul>
	Flashing	Printing is not possible. <ul style="list-style-type: none"> <li>• Ink has expired (2 months passed)</li> </ul>

## Media Sensor

The media sensor detects the presence/absence of media. The sensor must be covered by the media to detect the media width.

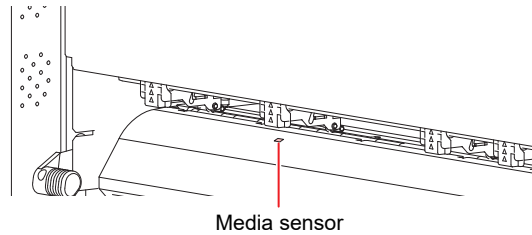

## Power Supply Switch

### ● Main power switch

This is located on the right-hand side of the product.

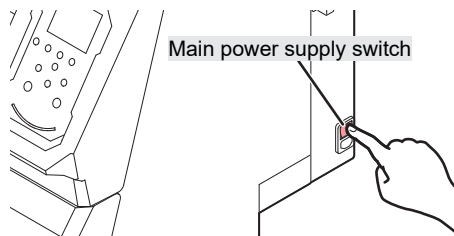

- Do not turn off the main power supply. Turning off the main power supply will disable the automatic maintenance function (including nozzle clogging prevention function and waste ink draining channel cleaning function). This will increase the risk of print defects (e.g., nozzle clogging, deflection).

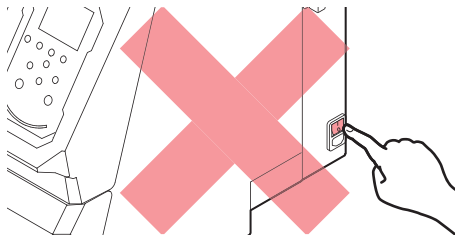

### ● [END/POWER] key

The [END/POWER] key is the key normally used to turn the power on and off.

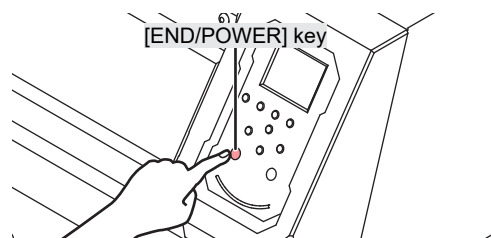

- Close the front cover and maintenance covers. Leaving any of the covers open will disable the automatic maintenance function (including nozzle clogging prevention function and waste ink draining channel cleaning function). This will increase the risk of failure or ejection failures (e.g., nozzle clogging or deflection).

## Operating Panel

This is used to control the product and make/change settings.

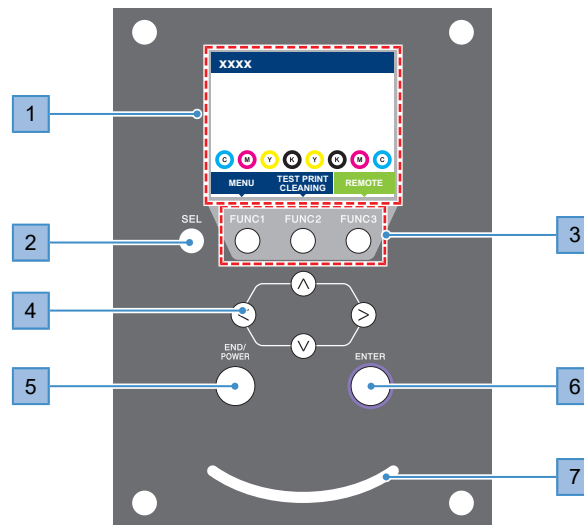

No.	Name	Overview																
1	Display	"Display"(P. 30)																
2	[SEL] key	Selects the function for the corresponding [FUNCTION] key.																
3	[FUNCTION] key	Used for test printing, head cleaning, and editing settings  "[FUNCTION] key"(P. 31)																
4	[JOG] key 	Used to move the carriage, feed media, and select settings																
5	[END/POWER] key	Used to cancel the last setting entered, return to the previous level of the setting menu, or to turn power on and off <ul style="list-style-type: none"> <li>• Illuminates in blue when the power is on.  "Turning On the Power"(P. 33)</li> <li>• To turn off the power, hold down the key.  "Turning Off the Power"(P. 34)</li> </ul>																
6	[ENTER] key	Used to move to the next level menu and to confirm settings. This can also be used to display product information.  "Displaying Machine Information (Local Guidance)"(P. 32)																
7	Status lamp	This lamp indicates the product status. <table border="1" data-bbox="454 1406 1445 1924"> <tbody> <tr> <td>Off</td> <td></td> <td>Indicates LOCAL mode. Used for test printing, maintenance, and settings</td> </tr> <tr> <td rowspan="2">Light blue</td> <td>Illuminated</td> <td>Indicates REMOTE mode. The product is in standby to receive print data.</td> </tr> <tr> <td>Flashing</td> <td>Indicates printing is underway. This also flashes to indicate test printing—for example, when printing built-in patterns.</td> </tr> <tr> <td>Blue</td> <td>Illuminated</td> <td>Indicates that data remains to be printed. Switch to REMOTE mode and start printing</td> </tr> <tr> <td rowspan="2">Red</td> <td>Flashing</td> <td>An error has occurred. Refer to the error code list and take appropriate action.  "Error Message"(P. 177)</td> </tr> <tr> <td>Illuminated</td> <td>A system error (SYSTEM HALT) has occurred. Contact our service office.  "SYSTEM HALT"(P. 183)</td> </tr> </tbody> </table>	Off		Indicates LOCAL mode. Used for test printing, maintenance, and settings	Light blue	Illuminated	Indicates REMOTE mode. The product is in standby to receive print data.	Flashing	Indicates printing is underway. This also flashes to indicate test printing—for example, when printing built-in patterns.	Blue	Illuminated	Indicates that data remains to be printed. Switch to REMOTE mode and start printing	Red	Flashing	An error has occurred. Refer to the error code list and take appropriate action.  "Error Message"(P. 177)	Illuminated	A system error (SYSTEM HALT) has occurred. Contact our service office.  "SYSTEM HALT"(P. 183)
Off		Indicates LOCAL mode. Used for test printing, maintenance, and settings																
Light blue	Illuminated	Indicates REMOTE mode. The product is in standby to receive print data.																
	Flashing	Indicates printing is underway. This also flashes to indicate test printing—for example, when printing built-in patterns.																
Blue	Illuminated	Indicates that data remains to be printed. Switch to REMOTE mode and start printing																
Red	Flashing	An error has occurred. Refer to the error code list and take appropriate action.  "Error Message"(P. 177)																
	Illuminated	A system error (SYSTEM HALT) has occurred. Contact our service office.  "SYSTEM HALT"(P. 183)																

## Display

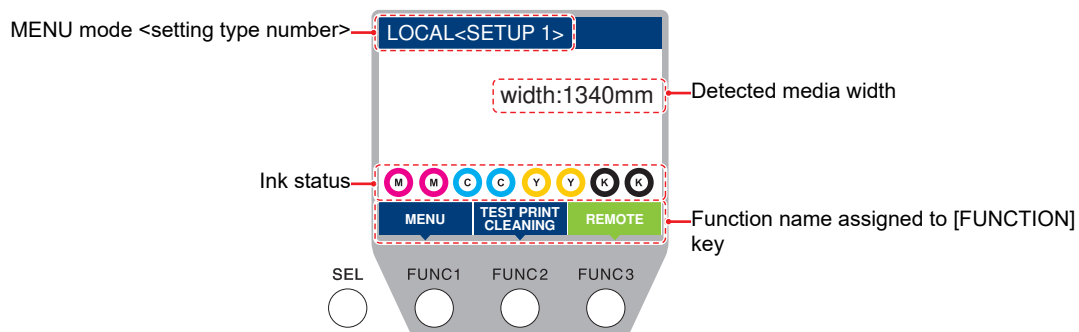

## MENU mode

Four menu modes are available.

Name	Overview
LOCAL mode	Used for test printing, maintenance, and settings
REMOTE mode	Prints the print data received from a PC.
MENU mode	Press the [MENU] on the LOCAL mode screen to switch to MENU mode. This is used to set various functions.
NOT-READY mode	Status before media is detected



## Ink status

Ink bottle status such as remaining ink levels and ink errors are indicated by icons.

Icon	Overview
	Displays remaining ink levels using a 9-stage icon.
	Full    1/8 used    1/4 used    3/8 used    1/2 used    5/8 used    3/4 used    7/8 used
	Displayed when ink is nearly depleted. Very little ink remains. Prepare fresh ink.
	Printing is not possible. Displayed when ink is depleted or an ink error has occurred. <a href="#">"Ink Errors"(P. 176)</a>
	Displayed when the ink has passed its expiration date. Replace with new ink or use up as quickly as possible. Printing is possible. <a href="#">"Restrictions Concerning the Machine"(P. 15)</a>

## [FUNCTION] key

This section describes the functions and roles assigned to the [FUNCTION] key.

Icon	Overview
	Displays the various menu screens.  "Settings"(P. 109)
	Displays maintenance functions such as test printing and cleaning.
	Switches from LOCAL mode to REMOTE mode.
	Displays adjustment functions such as feed adjustment and drop position adjustment.
	Clears received data.
	Used to switch from REMOTE mode to LOCAL mode
	Used to cut media
	Used to move to the previous menu screen
	Used to move to the next menu screen
	Used to close the confirmation screen in response to prompts or other messages
	Used to disable functions
	Indicates that the function is assigned. Displays settings and functions.
	Used to enable or disable multiple items
	Displays the cutting condition input screen.
	Displays the test cutting and other cutting related function screens.
	Displays the pinch roller setting screen.

## Displaying Machine Information (Local Guidance)

---

Press the [ENTER] key on the LOCAL mode screen to display the following information.

- Ink information: Displays ink type, remaining ink levels, and ink errors.
- Ink IC chip registration information: Displays the information registered on the ink IC chip.
- Warning: Displays all warnings issued.
- Information: Displays information such as media width, head height, product serial number, firmware version, command version, and LAN connection status.
- Nozzle check: Displays the number of nozzles detected as clogged in the nozzle check.



## 1.2 Connecting the Power Cable

- 1 Check to confirm that the main power supply is turned off.
- 2 Insert the cable band to the machine.
- 3 Plug the power cable into the inlet of the machine.
- 4 Secure the power cable to the cable band.
  - Pass the power cable through the clamp and clamp until it clicks into place.

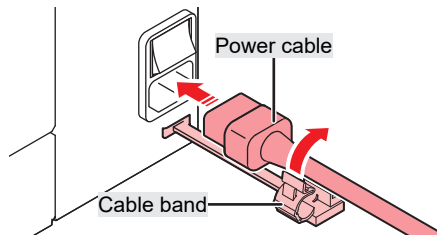

- 5 Plug the power plug into the power outlet.

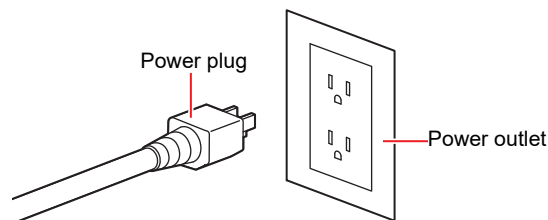

- Do not handle the power plug with wet hands. Disregarding this precaution may result in electric shock.

### Turning On the Power



- Close the front cover and maintenance covers. Leaving any of the covers open will disable the automatic maintenance function (including nozzle clogging prevention function and waste ink draining channel cleaning function). This will increase the risk of failure or ejection failures (e.g., nozzle clogging or deflection).

- 1 Check to confirm that the main power supply is turned on.
  - If the main power supply switch is not turned on, set to "I".

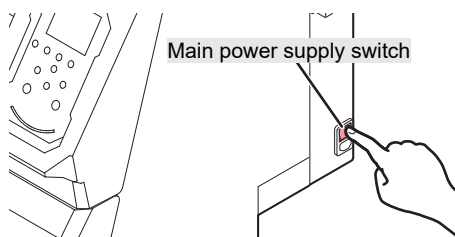

## 2 Press the [END/POWER] key to turn on power.

- The firmware version appears on the display, and the initial operation is executed. LOCAL mode is then set and the machine is ready for use.

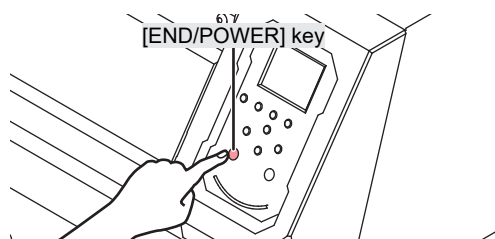

## 3 Turn on the power for the connected PC.

### Turning Off the Power



- Check the following when turning off power:
  - (1) The front cover and maintenance covers are closed.
    - Leaving any of the covers open will disable the automatic maintenance function (including nozzle clogging prevention function and waste ink draining channel cleaning function).
  - (2) The carriage has returned to the capping station.
    - If not, the print head nozzle may dry out, resulting in printing defects (e.g., nozzle clogging or deflection).
  - (3) Data is not being received
  - (4) No errors have occurred.
    -  ["Problems Causing Messages to Appear"\(P. 174\)](#)

## 1 Turn off the power to the PC connected.

## 2 Hold down the [END/ POWER] key.

- A power off confirmation screen appears. Press the [ENTER] key to turn the power off.

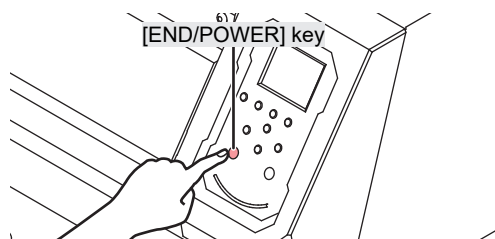

- Do not turn off the main power supply. Turning off the main power supply will disable the automatic maintenance function (including nozzle clogging prevention function and waste ink draining channel cleaning function). This will increase the risk of print defects (e.g., nozzle clogging, deflection).

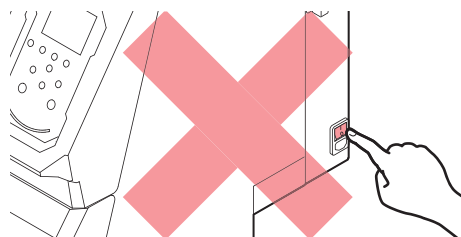

# 1.3 Connecting a PC to the Product

## Using a USB Cable

Connect a PC to this product using a USB interface cable.



- Do not unplug the cable while data is being transferred.



- Use RIP software that supports the USB interface.



- If the PC does not have a USB port, contact your local distributor, our sales office, or service center.

## USB Connection Precautions

### ● When connecting more than one UCJV300 Series, 150 Series to a PC

The UCJV300 Series, 150 Series may not be correctly recognized.

If the PC has more than one USB port, try connecting to a different USB port to check whether the product is correctly recognized. If the product is still unrecognized even when connected to a different USB port, use a commercially-available USB active repeater cable.

### ● When extending the USB cable

Use a commercially-available USB active repeater cable. However, make sure that the combined length of the USB cable and the USB active repeater cable does not exceed 20 m.

Data transfer speeds to this product may be reduced if the USB cable is extended. This may cause the carriage to temporarily stop at the left-hand or right-hand end during printing.

### ● USB high-speed mode peripheral devices

It may not be possible to recognize USB peripheral devices if USB high-speed mode peripheral devices (e.g., USB memory, USB HDD devices) are connected to the PC to which the product is connected. Data transfer speeds to this product may be reduced if external USB hard disk drives or similar devices are connected. This may cause the carriage to temporarily stop at the left-hand or right-hand end during printing.

### ● Unplugging USB memory devices

When unplugging USB memory devices from the PC to which this product is connected, use "Stop" in "Safely removing hardware" before unplugging. Otherwise, an [ERROR 201 Command Error] will occur.

## Using a LAN Cable

Connect a PC to this product using a LAN cable. Insert a LAN cable until it engages with a click.



- Do not unplug the cable while data is being transferred.

### ● Network Connection Precautions

Make sure the network is set up as follows: Printing is not possible if the network is not set up correctly.

- Use a Category 6 or higher LAN cable.

- The PC used to transfer print data must be located on the same network as this product. This product cannot be connected via a router.
- Use a 1000BASE-T compatible computer or switching hub. Printing requires 1000BASE-T support.

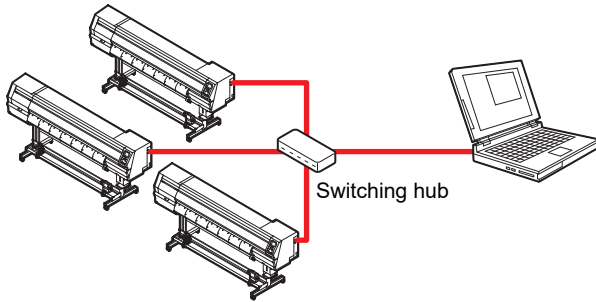

## ● Checking the LAN connection

### 1 Check the display on this product.

- Local guidance can be used for checking. ["Displaying Machine Information \(Local Guidance\)"\(P. 32\)](#)
- Printing is not possible if "100Mbps", "10Mbps", or "No Connect" is displayed. Event email can be used. ["Event Email Function Settings"\(P. 120\)](#)

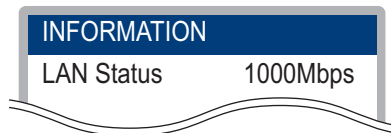

### 2 Check the lamp on the LAN connector.

- The LAN connector lamp illuminates when the machine is running.

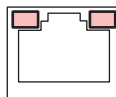

Color	Status	Overview
Green	Illuminated	Connected via 1000BASE-T
	Off	Connected via a network other than 1000BASE-T <ul style="list-style-type: none"> <li>• 1,000 Mbps is not supported if only the orange lamp is illuminated or flashing. Check the specifications for the PC, peripheral devices, and cable.</li> </ul>
Orange	Illuminated	Linked up (connected).
	Flashing	Data being received
	Off	Link down (not connected)

# 1.4 System Configuration

Use RIP software to request to print data created using applications like Illustrator or Photoshop.

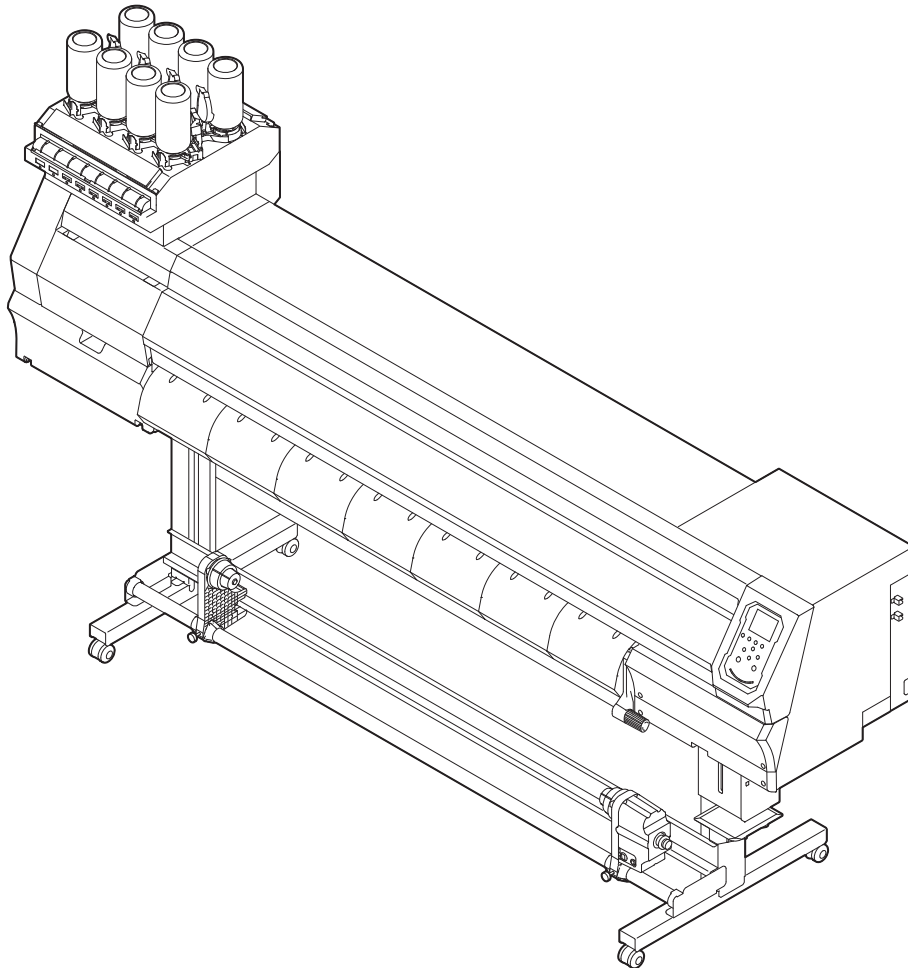
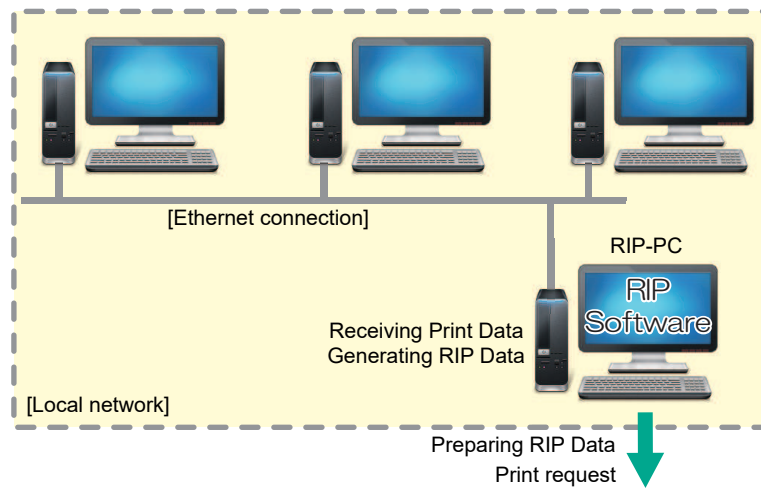

## Installing the Mimaki Driver

### 1 Download the Mimaki driver from our website.

- <https://mimaki.com/download/inkjet.html>  
[UCJV300 Series, 150 Series] > [Driver/Utility]

### 2 Install the MIMAKI driver.

## Installing RIP Software

The explanation here applies to MIMAKI RIP software (RasterLink).

### 1 Install RasterLink.

- The following icon appears on the PC desktop once the software has been installed.



- For more information, refer to the RasterLink installation guide. <https://mimaki.com/download/software.html>



- Once installed, activate the license for Rasterlink. Otherwise, "Profile Update" will not start.

## Obtaining Color Profiles

Print quality (e.g., tone, bleeding) will vary depending on the media and ink set. To maintain consistent print quality, select a color profile that suits the media and ink set.

The explanation here applies to MIMAKI RIP software (RasterLink).

### 1 Launch "Profile Update".

- (1) From the Start menu, select [Mimaki RasterLink6Plus] > [Profile Update].
- (2) Click [Next].

### 2 Select the UCJV300 Series, 150 Series being used.

- Select the check box for the ink set and ink type being used, then click [Next].

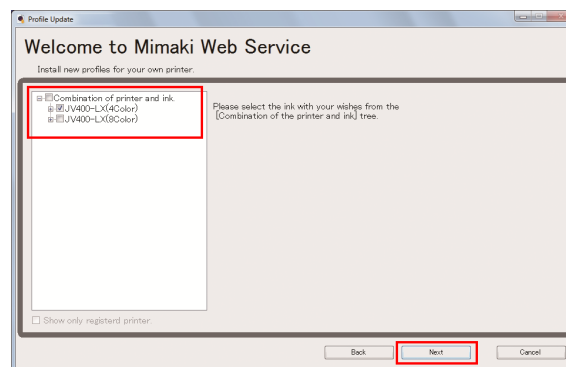

- Expanding the [+] button allows selection of the ink type.

### 3 Set the search options, then click [Next].

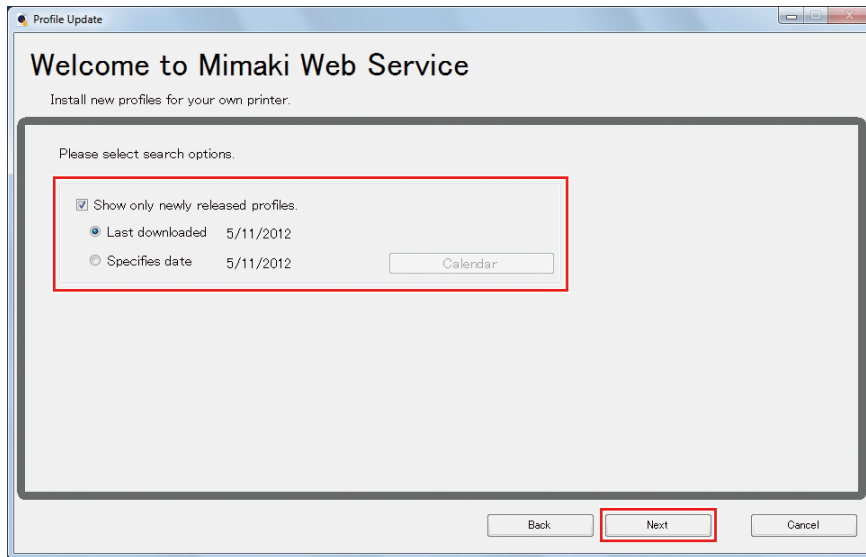

### 4 Download the color profile.

- (1) Select the check box for the color profile corresponding to the media and resolution to be used.

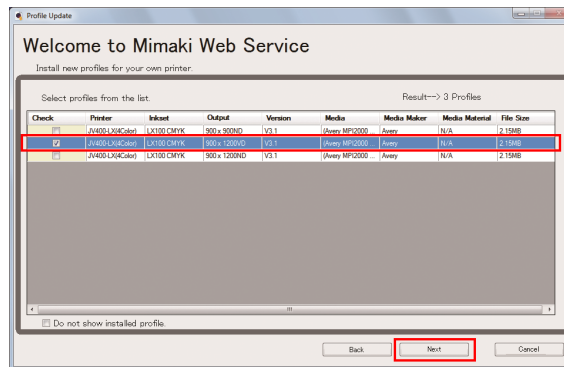

- (2) Click [Next].
  - The profile downloaded here will be installed the next time RasterLink is launched.

### 5 Click [Complete].

- "Profile Update" closes.



- For more information, refer to the RasterLink installation guide. <https://mimaki.com/download/software.html>



- The latest color profiles can also be downloaded from our website. The profiles downloaded can be installed using Profile Manager. <https://mimaki.com/download/inkjet.html> [UCJV300 Series, 150 Series] > [Profile]

## Setting Up RIP Software

The explanation here applies to MIMAKI RIP software (RasterLink).

## 1 Launch RasterLink.

- The [Printer Management] screen appears.
- To add a new model, launch RasterLink, then select [Environment] > [Printer Management].

## 2 Register UCJV300 Series, 150 Series.

(1) Click [Add].

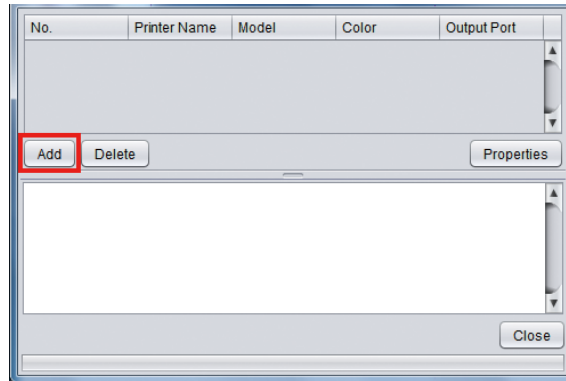

(2) Set the specifics for UCJV300 Series, 150 Series.

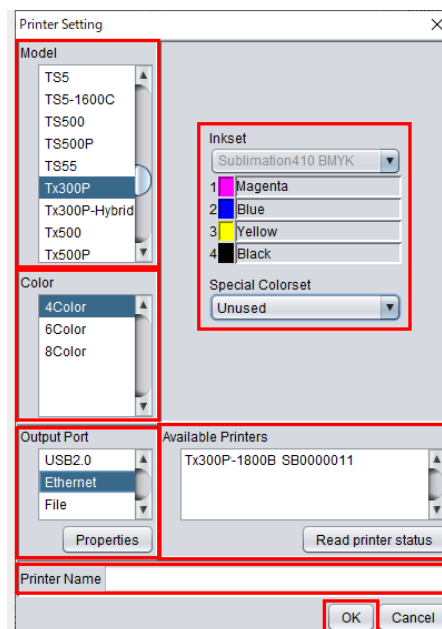

- Model: Select the model.
- Color: Select the ink set filled.
- Output Port: Select the cable connected.
- Available Printers: Select UCJV300 Series, 150 Series connected.
- Printer: Enter a name as required.

(3) Click [OK].

- A confirmation screen appears.

(4) Click [Yes].

- Printer registration starts.



- For more information, refer to the RasterLink installation guide. <https://mimaki.com/download/software.html>



# 1.5 Ink Replacement Method

## When Ink Near End is Displayed

Ink levels are low. We recommend replacing with new Ink bottle as soon as possible. Printing is still possible, but cleaning and continuous printing are not possible. Note that ink may run out during printing.

To check which Ink bottle needs to be replaced, press the [ENTER] key on the LOCAL mode screen.  ["Displaying Machine Information \(Local Guidance\)"\(P. 32\)](#)

## When Ink End is Displayed

The ink has run out. Replace with new Ink bottle.

Thoroughly read the following and make sure you understand its contents.

 ["Ink or any Other Liquid Used with the Machine"\(P. 13\)](#)



- Pay close attention to ventilation and be sure to wear safety glasses, gloves, and a mask when handling ink, maintenance liquid, waste ink, or other solutions used with the machine. Leaking ink may adhere to the skin or get into the eyes or mouth.

## Replacing Ink

### ● Removing the Ink bottle

- 1 Rotate the lever on the tank section from left to right.

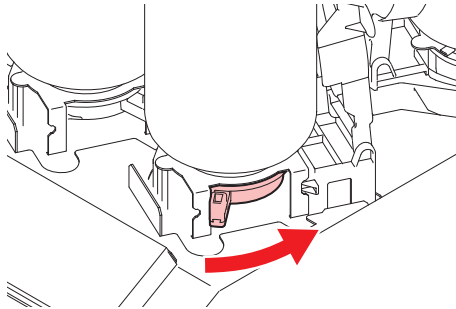

- Never attempt to rotate the ink bottles. Doing so may result in leaking ink.

- 2 Lift the ink bottles vertically.

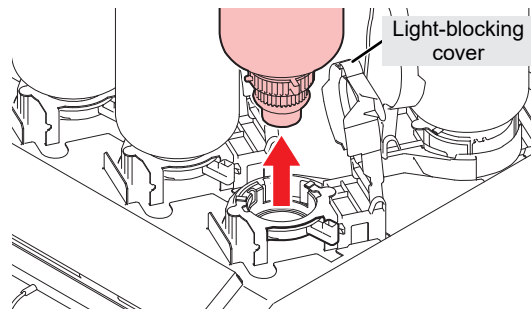

- Check to confirm that the light-blocking cover is closed when removing ink bottles. Close the light-blocking cover by hand if it is open. If the light-blocking cover is left open, the ink may harden, resulting in printer failure.
- Be careful to prevent ink leaks from the ink bottles.



- The O-ring fitted to the bottle caps may become detached when removing an ink bottle. Refit the O-ring if it becomes detached.

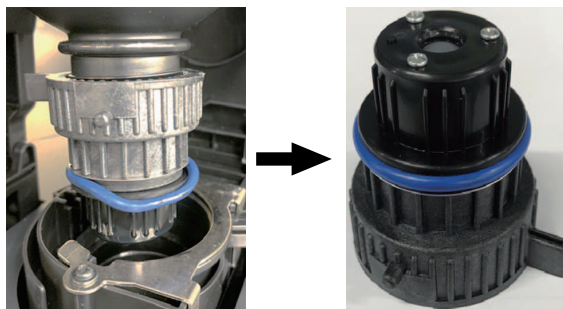

### 3 Soak up any ink droplets on the special caps.

- Use a wipe filter to soak up ink droplets and prevent dripping.

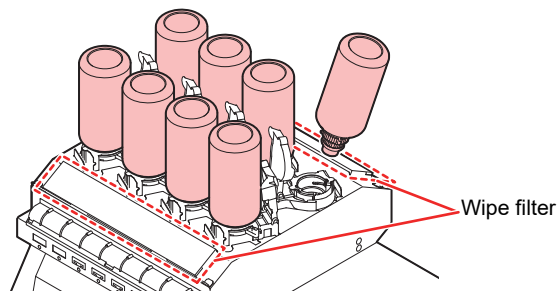

### 4 Wipe off any ink on the special caps with a paper towel.



- Check to confirm that there is no foreign matter, such as paper towel scraps or dust, adhering to the ink bottle caps. Continuing to use it when it is dirty may result in foreign matter blocking the ink channels, causing ink leakage.

### 5 Remove the special caps from the ink bottles.

- If the special caps are tight, remove using a tightening tool.

### 6 Remove the ink IC chip.

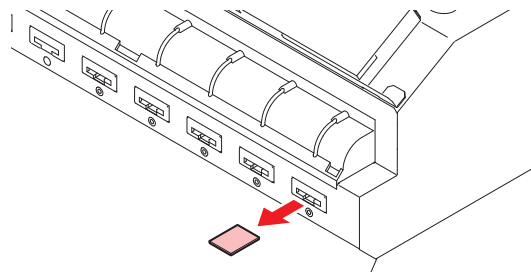

- When disposing of the product, contact an industrial waste disposal operator or dispose of the product in accordance with the local laws and regulations.

## ● Preparing the Ink bottle

### 1 Shake the Ink bottle to the left and right slowly at least 20 times.

- Tighten the ink bottle lid securely, then shake the bottle slowly from left to right to ensure that the ink moves inside, holding the ink bottle lid with a paper towel.

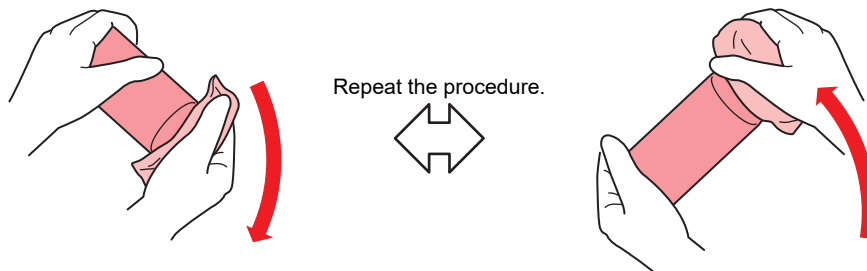

- Shake slowly. If the bottle is shaken too violently, ink may leak out or the air mixed in the ink may cause nozzle clogging.
- If the ink bottle is partially used, tilt it slowly until the ink bottle is upright.

### 2 Remove the ink bottle lid.

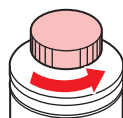

- If the mouth of the ink bottle is fitted with a seal

- (1) Use a craft knife to cut around and remove the seal. Ink leakage may result if parts of the seal remain.

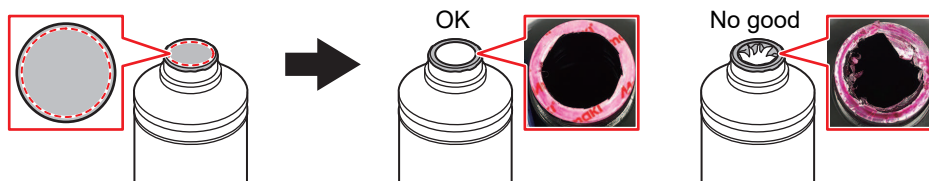

- (2) Do not damage the mouth of the ink bottle. Ink may leak from damaged parts.
- (3) Be careful not to allow any seal fragments to fall inside the bottle. Using ink bottles with seal fragments inside may cause the bottle cap to become blocked, preventing ink supply.

### 3 Attach the special caps to the ink bottles.

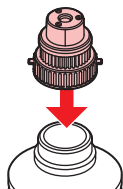



- Wipe off any ink or maintenance liquid remaining on the ink bottles and bottle caps. Otherwise ink leakage may result due to the loosened the ink bottle caps.



- Check to confirm that there is no foreign matter, such as paper towel scraps or dust, adhering to the ink bottle caps. Continuing to use with foreign matter present may result in foreign matter blocking the ink path, causing ink leakage.

#### 4 Use the tightening jig to tighten the special caps in place.

1

2

Tightening tool

<p>[SPA-0232]</p> <p>Position the upper arrow within this range!</p>	<p>Good example</p>	<p>Bad example</p>
<p>[SPA-0328]</p> <p>Position the upper arrow within this range!</p>	<p>Good example</p>	<p>Bad example</p>



- Do not overtighten the ink bottle caps. Disregarding this precaution may result in damage, idling or ink leakage. If the arrow moves beyond the above range, loosen the ink bottle caps, and repeat the steps again.
- Do not leave ink bottles with the ink bottle caps fitted for extended periods. Disregarding this precaution may result in the ink hardening.

#### 5 Turn the ink bottle upside-down to check that no ink leaks occur.

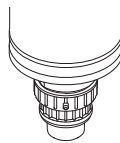

● **Mounting the Ink bottle**

The order of Ink bottle to be set depends on the ink set you are currently using. Check the ink slot numbers, then insert the correct color Ink bottle.

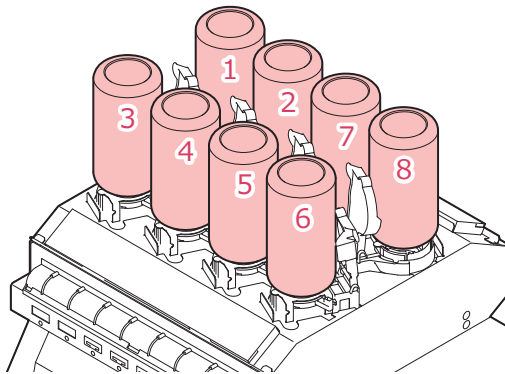

Model	Ink set	Ink bottle positions (specified by color)							
		1	2	3	4	5	6	7	8
300 series	4-color	C	M	Y	K	Y	K	M	C
	4-color, W	C	C	M	M	Y	K	W	W
	4-color, W, CL	C	M	Y	K	CL	CL	W	W
	6-color, W	C	M	Y	K	Lm	Lc	W	W
150 series	4-color	-	-	C	M	Y	K	-	-

**1 Mount the ink bottles.**

- Rotate the lever from the left to the right side, then mount the ink bottle.

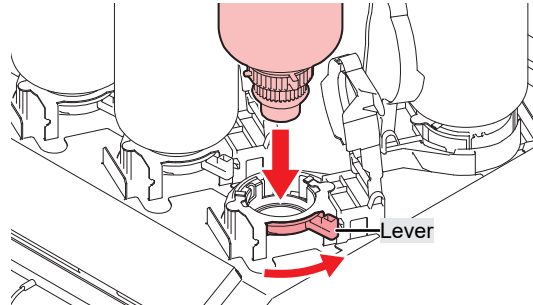

- You may apply the maintenance liquid onto the O-ring of the ink bottle caps so that the ink bottle can be inserted easily. Use the appropriate maintenance liquid to suit the ink being used.



**2 Rotate the lever from the right to the left to secure in place.**



- Never attempt to rotate the ink bottles. Doing so may result in leaking ink.



- Once the ink bottle is mounted, use up the ink as quickly as possible.

### 3 Insert a new ink IC chip into the slot on the ink supply unit.

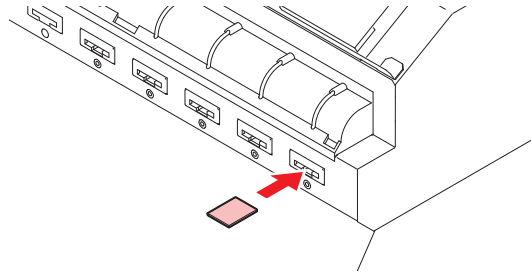

- Insert the ink IC chip with the metal side facing up. Inserting it in the wrong way may cause failure of the machine or damage the ink IC chip.



- Do not touch the metal parts of the ink IC chip. Static electricity may damage the ink IC chip, and dirt or damage may make the ink IC chip unreadable.

#### • Ink IC chips

The marking on the ink IC chip indicates the color information.

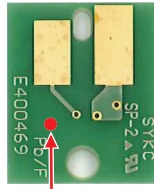

Marking locatio

Ink Color	Marking
Cyan	● (One blue circle)
Magenta	● (One red circle)
Yellow	● (One yellow circle)
Black	● (One black circle)
Light cyan	●● (Two blue circles)
Light magenta	●● (Two red circles)
White	○ (One white circle)
Clear	○○ (Two white circles)



- Insert the ink IC chip included in the package with the ink. The ink IC chip stores information such as the ink color, remaining amount, and expiration date. Printing is not possible if an incorrect ink IC chip is inserted.





# Chapter 2 Printing



## This chapter

This chapter describes printing procedures and settings.

Print Process .....	50	Test Printing .....	69
Adjusting the Print Head Height. ....	53	Changing the Layout Direction for Test Printing .....	69
Adjusting the Pinch Roller Positions.....	54	Checking White Ink Ejection .....	69
1,600 mm Size .....	55	Ejection Failures .....	70
1,300 mm Size .....	56	Head Cleaning.....	71
1,070 mm Size .....	57	Feed Correction.....	72
750 mm Size .....	58	Feed Correction Procedure.....	72
Loading the Media .....	59	Correcting the Drop Position .....	74
Media .....	59	Drop Position Correction Procedure .....	74
Take-up unit .....	59	Preparing RIP data .....	75
Loading the Roll Media .....	61	Printing .....	77
Setting Leaf Media .....	65	Changing the Origin .....	77
Setting the Pressure and Number of Pinch Rollers to Use .....	68	Starting Printing .....	77
		Stopping Printing (Data Clear) .....	78
		Cutting the media .....	79

## 2.1 Print Process

### 1. Turn on the power.

 ["Turning On the Power"\(P. 33\)](#)

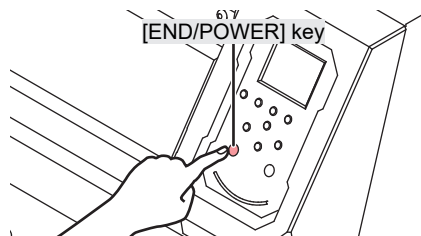

### 2. Connect a RIP PC to the machine.

 ["Using a USB Cable"\(P. 35\)](#)

 ["Using a LAN Cable"\(P. 35\)](#)

### 3. Setting Up RIP Software

 ["Installing RIP Software"\(P. 38\)](#) (required first time only)

 ["Obtaining Color Profiles"\(P. 38\)](#)

 ["Setting Up RIP Software"\(P. 39\)](#) (required first time only)

### 4. Adjust the print head height

Adjust the height adjustment lever to suit the media.  ["Adjusting the Print Head Height."\(P. 53\)](#)

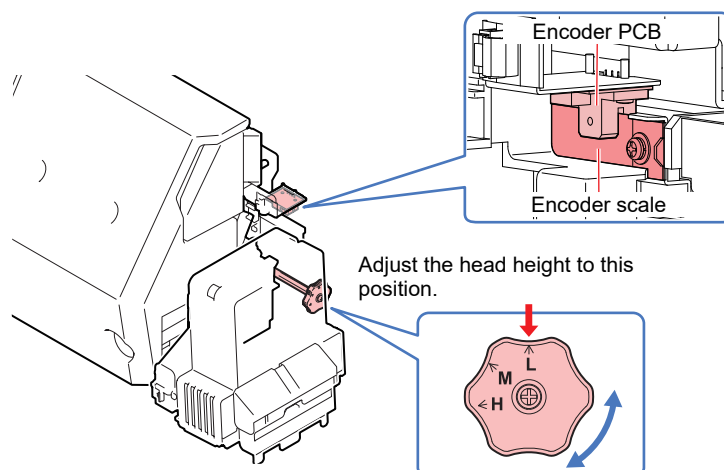

### 5. Adjust the pinch roller positions

Adjust the pinch roller positions to suit the width of the set media. Adjust the pinch roller positions so that the pinch rollers are positioned above the grit rollers. The pinch rollers at both ends should be aligned to within 10 cm from the left edges and 2 cm from the right edges of the media. 📖 ["Adjusting the Pinch Roller Positions"\(P. 54\)](#)

## 6. Loading the media

This machine can be used with roll media and leaf media. 📖 ["Loading the Media"\(P. 59\)](#)

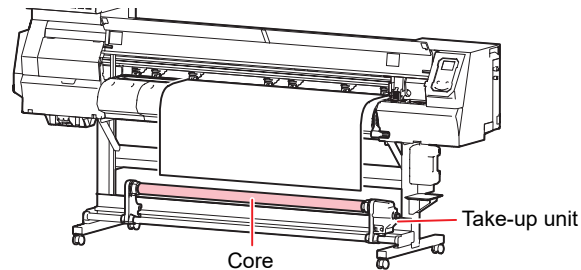

## 7. Adjust the number and pressure of pinch rollers to use.

Set an appropriate pressure for the set media. 📖 ["Setting the Pressure and Number of Pinch Rollers to Use"\(P. 68\)](#)

## 8. Check the state of the print head nozzles.

📖 ["Test Printing"\(P. 69\)](#)

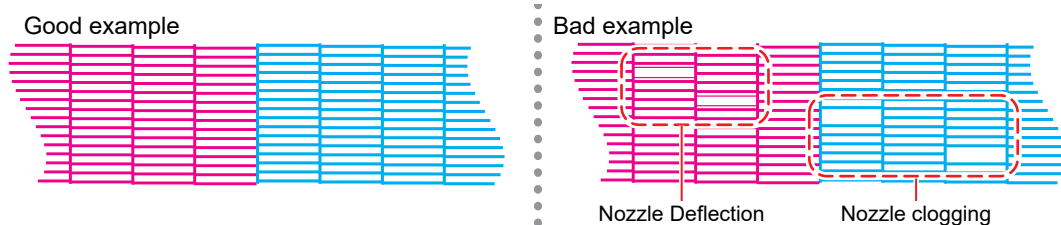

## 9. Clean the head to clear malfunctioning nozzles.

There are four different head cleaning methods. Choose the head cleaning method based on test print results. 📖 ["Head Cleaning"\(P. 71\)](#)

## 10. Adjust the media feed amount.

📖 ["Feed Correction"\(P. 72\)](#)

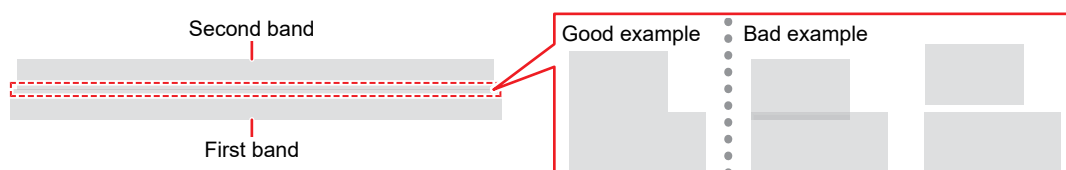

# 11. Adjust the drop position for bi-directional printing.

☞ "Correcting the Drop Position"(P. 74)

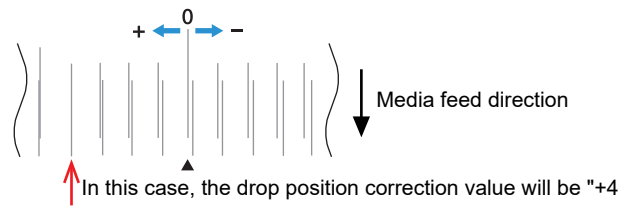

# 12. Printing RIP data

☞ "Printing"(P. 77)

# 13. Cutting the media

☞ "Cutting the media"(P. 79)

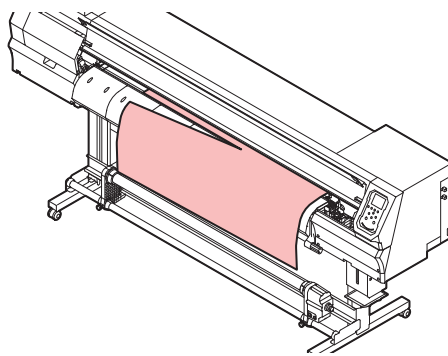

## 2.2 Adjusting the Print Head Height.

Adjust the height of the print head according to the thickness of the media you are using.

Range	Gap between print head and platen
Low	2 mm (default setting)
Middle	2.5 mm
High	3 mm



- Be sure to correct the dot position after altering the print head height.  "Correcting the Drop Position"(P. 74)
- The print head height should normally be set to 2.0 mm. With inkjet printers, if the gap between the print and media increases, the ink droplets may vaporize before they reach the media. Vaporized ink will adhere to the print head nozzle surface, media, and cooling fan filter. The amount of reflected light incident on the print head surface from the UV-LED unit will also increase. Reflected light may cure vaporized ink adhering to the nozzle surface. This will increase viscosity, reduce print quality, and generate print head faults.

### 1 On the LOCAL mode screen, select [MENU] > [Maintenance], then press the [ENTER] key.

- The Maintenance menu is displayed.

### 2 Select [Station] > [Carriage Out] > [Station Maint.], then press the [ENTER] key.

- The carriage moves over the platen.

### 3 Open the front cover.

### 4 Use the height adjustment lever to adjust the height.

- Set the height adjustment lever so that the desired height is at the top. If the lever is not set to the correct position, problems such as media jamming and misting may occur, resulting in impaired print quality.

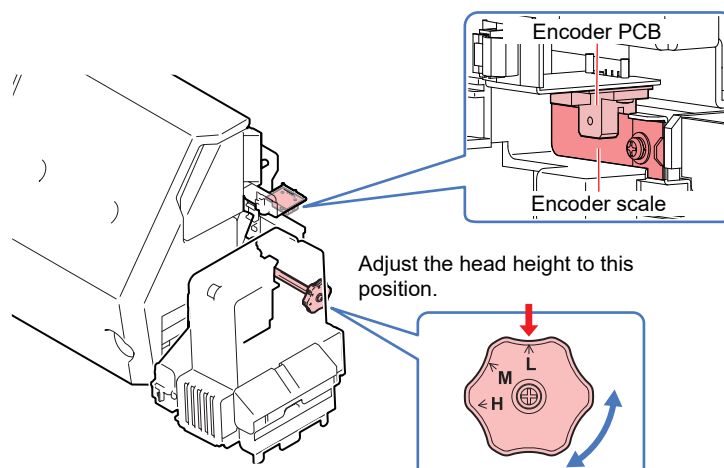

- Be careful not to touch the encoder scale or encoder PCB when using the height adjustment lever.

### 5 Once adjustment is complete, close the cover, then press the [ENTER] key.

## 2.3 Adjusting the Pinch Roller Positions

Adjust the pinch roller positions to suit the width of the media being used.



- Always use at least two pinch rollers.

### 1 Choose the grit rollers capable of holding down the media at equal intervals.

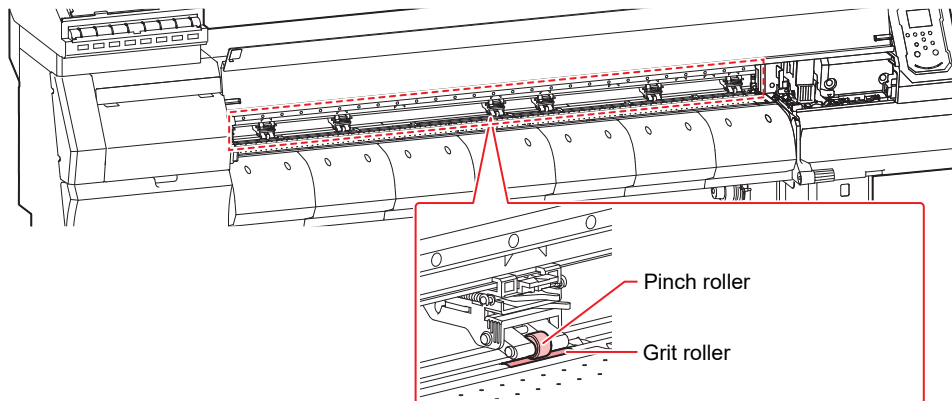

### 2 Move the pinch rollers above the grit rollers.



- Use the pinch roller guide marks as references.

- When adjusting from the front

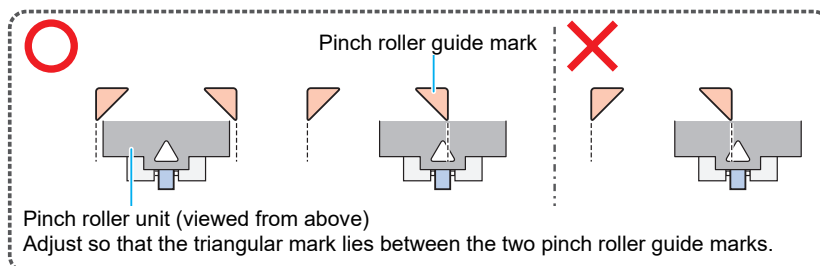

- When adjusting from the rear

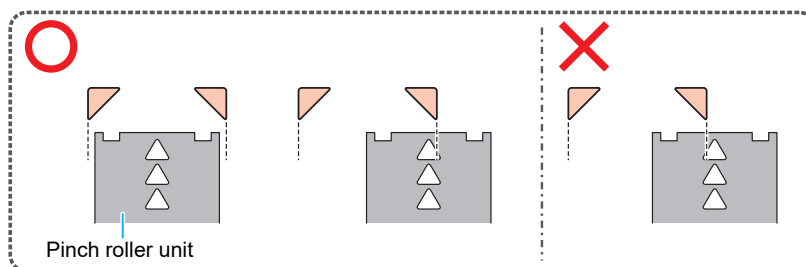

### 3 Align the pinch rollers at both the ends to within 10 cm from the left edges and 2 cm from the right edges of the media.

- Placement farther from the edges may leave some portions of the media uncut.

### 4 Remove the pinch rollers lying outside the media from the grit rollers.

- Feeding media with the pinch rollers and grit rollers in contact will cause pinch roller wear.

1,600 mm Size

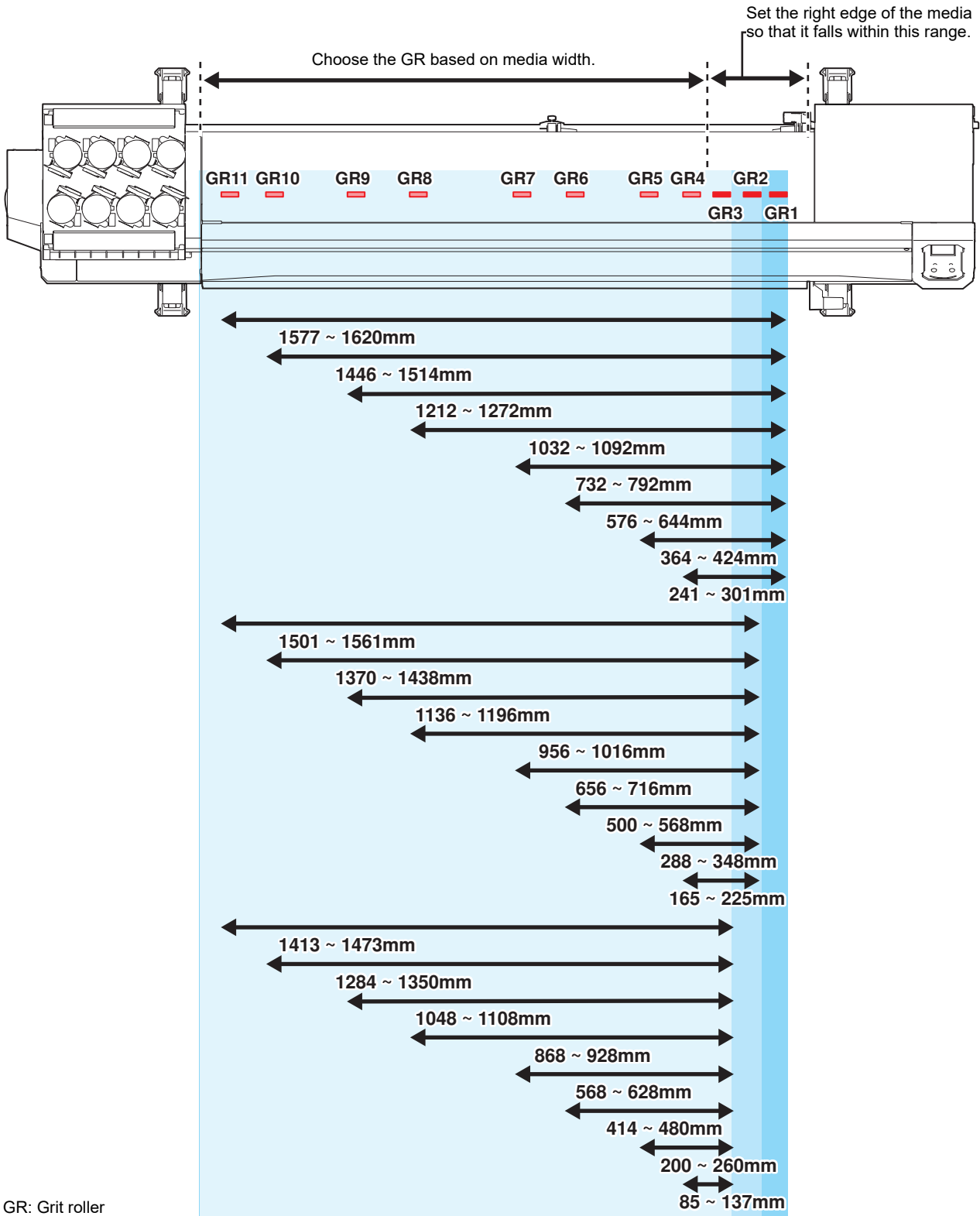

# 1,300 mm Size

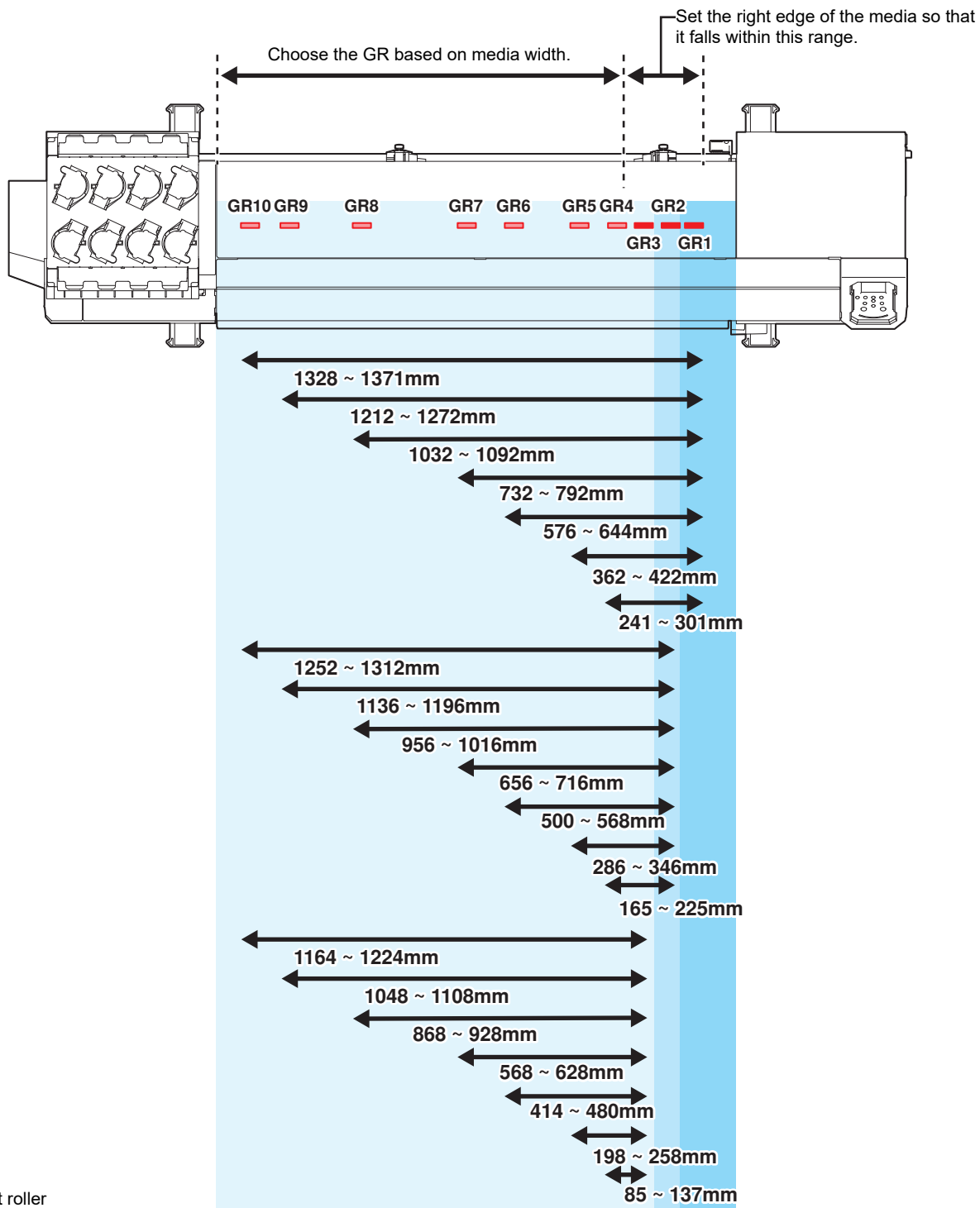

GR: Grit roller



## 1,070 mm Size

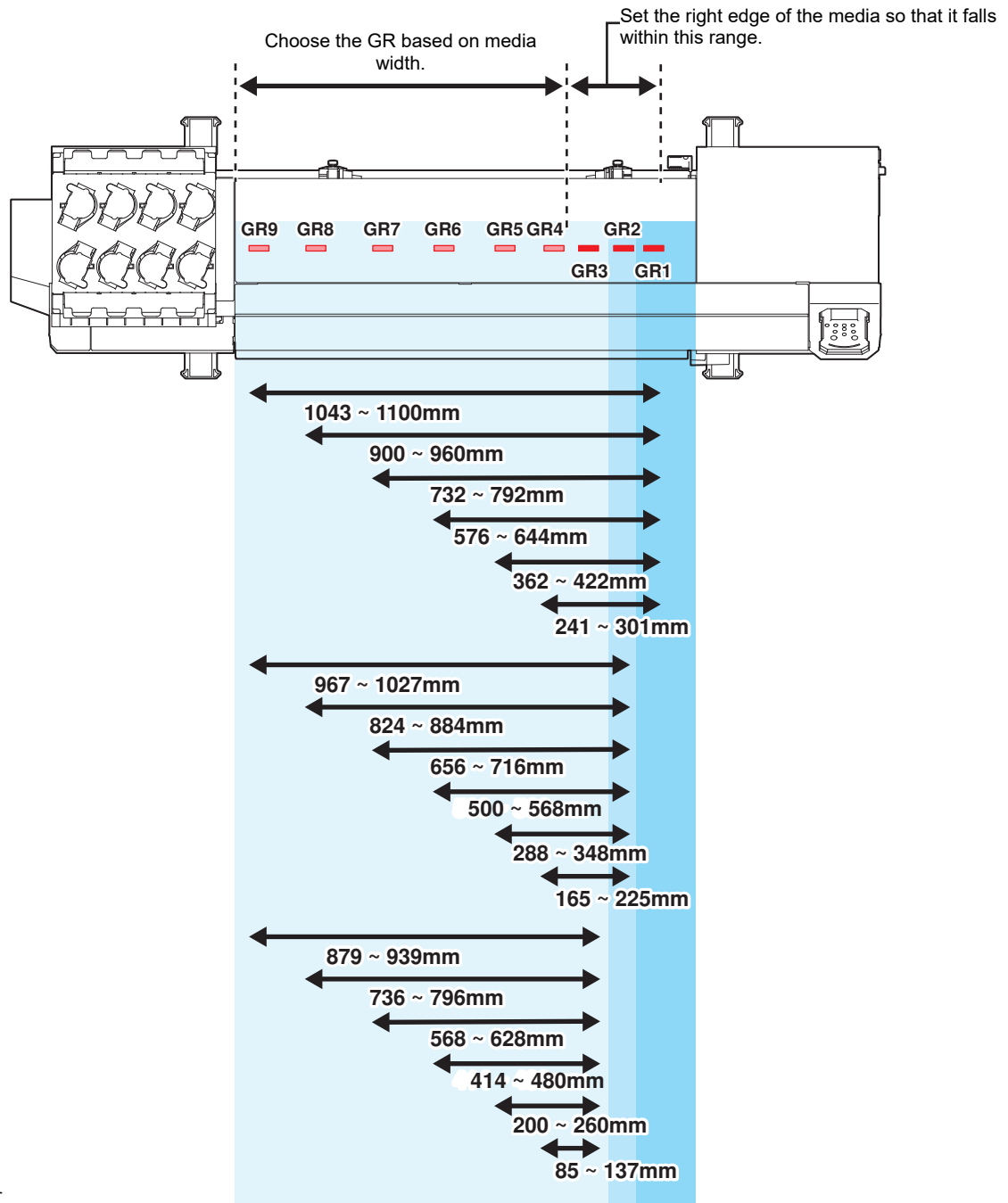

GR: Grit roller

# 750 mm Size

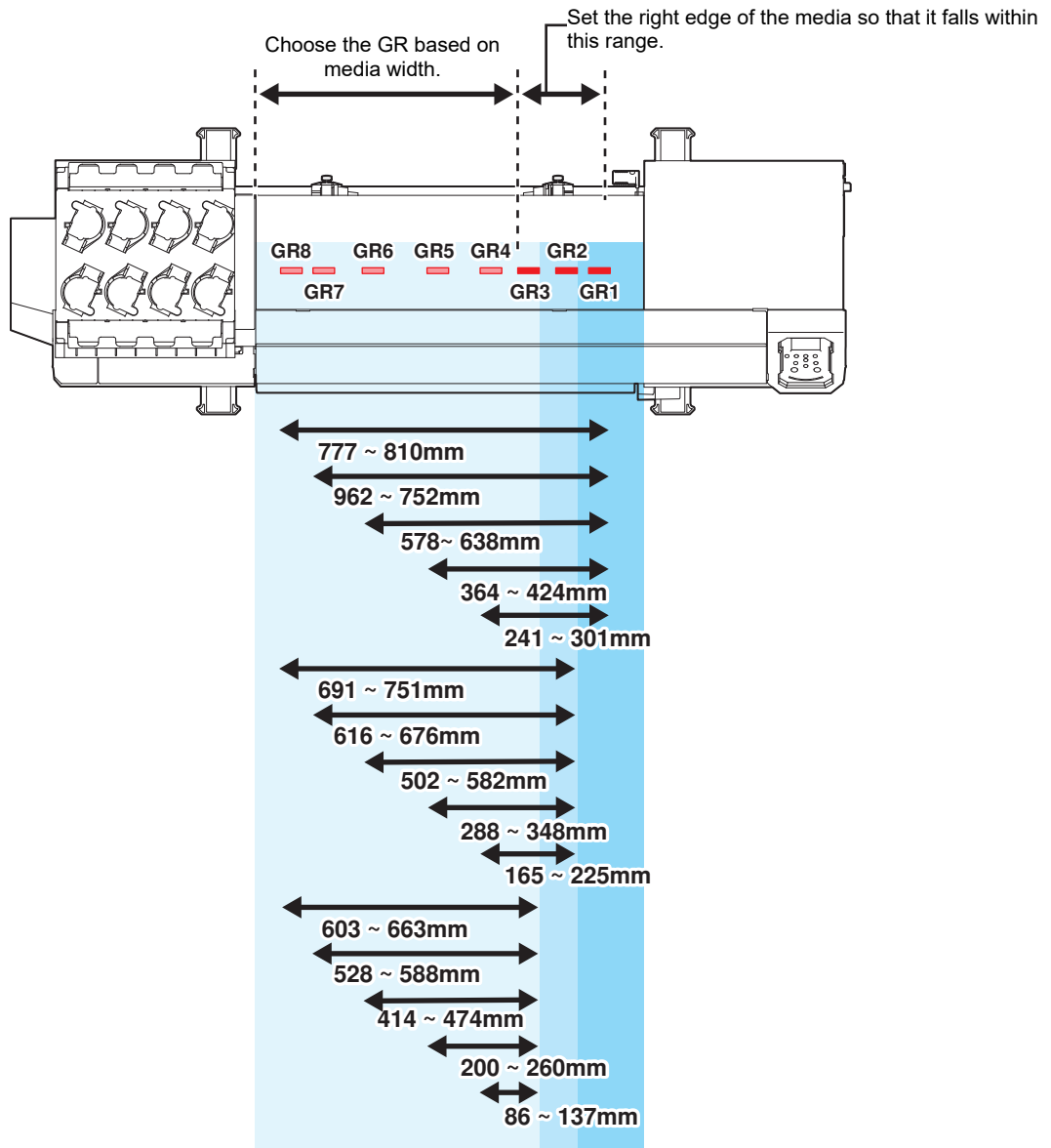

GR: Grit roller

## 2.4 Loading the Media



- Adjust the head height before loading media. Moving the carriage after the media has been loaded may result in the print head coming into contact with the media and being damaged.

### Media

#### ● Media handling precautions



- Use Mimaki-approved media to ensure consistent high-quality printing.

#### ⚠ WARNING



- Assign at least two people to load roll media. Otherwise there is a risk of back injury due to the weight of the media.

#### NOTICE



- Protect media from dust when stored. Otherwise print quality may be reduced.
- When storing standard-size media rolled up, store with the coated surface facing out.
- Take precautions to prevent static electricity buildup on media (e.g., by using ionizers, discharging bars, water mist humidification, or alcohol-based anti-static solutions). Do not use anti-static solutions that contain detergent.



- Do not leave media loaded in the machine. This may cause dust to collect on media. Also, do not use media after wiping off dust. The static electricity generated by wiping may impair print quality.
- Do not use media immediately after removing from the packaging. The media may expand or shrink depending on the ambient temperature and humidity at the storage location. Allow to sit for at least 30 minutes in the same room conditions as this machine before loading.
- Do not use curled media. Doing so may result in damage to the print head and impaired print quality.
- Do not use mirrors, polished stainless steel plate, or gold or silver foil media. Light reflected from the media surface may result in print head ink hardening and damage to the head. Such damage is not covered by the warranty.

### Take-up unit

Use the switch on the take-up unit to change the media take-up direction.

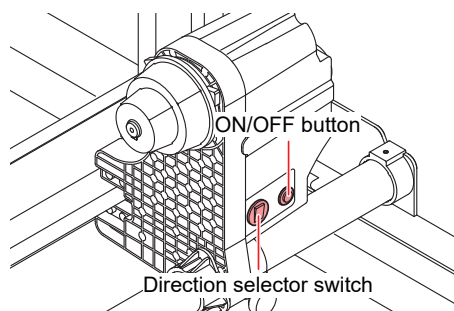

Name	Overview	
Direction selector switch	Up	To take up media with printed surface on the inside
	Down	To take up media with printed surface on the outside
ON/OFF button	Press the button to start/stop the take-up unit. The setting can be altered so that the take-up unit operates only while the button is depressed.  <a href="#">"Machine setup menu"(P. 118)</a>	

## Adjusting the Torque Limiter

The take-up unit is fitted with a torque limiter.

Turn the torque limiter adjustment nut to adjust take-up tension. The torque limiter is initially set to "Medium" when shipped.

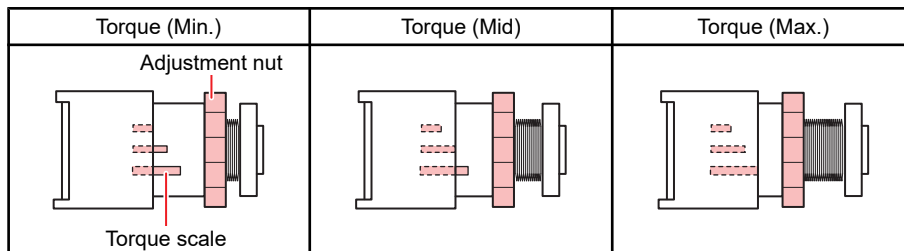

### ● Increase tension (clockwise)

Increase tension when using with heavy or thick media, such as tarpaulin. Perform adjustments manually.

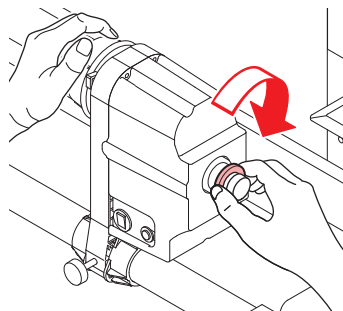

- Do not use the torque adjustment handle. Using the torque adjustment handle will cause overtightening. Overtightening may damage the take-up unit.

### ● Decrease tension (counterclockwise).

Decrease tension when using lightweight media. Use the "torque adjustment handle" provided.

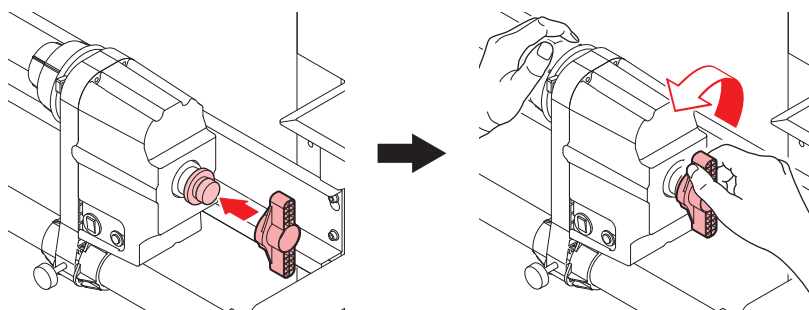

## Loading the Roll Media

- 1 Raise the clamp lever.

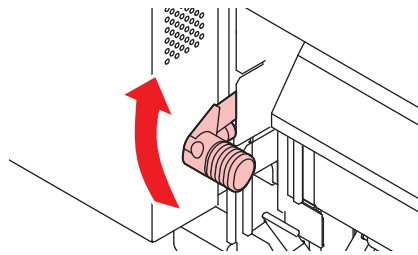

- 2 Move the rear left roll holder to the roll setting position.

- Unscrew the roll holder retaining screw before moving.

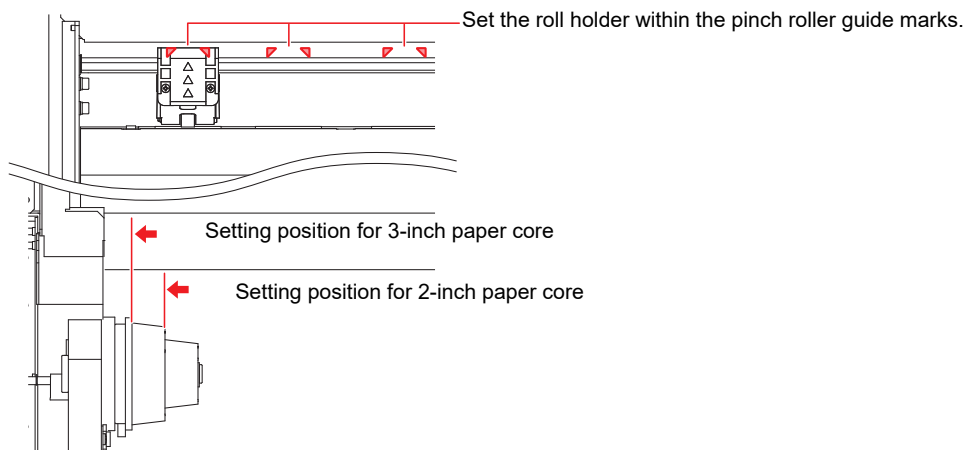

- 3 Tighten the retaining screw on the rear left roll holder.

- 4 Place roll media on the roll media hanger.

- 5 Insert the paper core of the roll media on to the rear left roll holder.

- Push in until the paper core moves no farther.

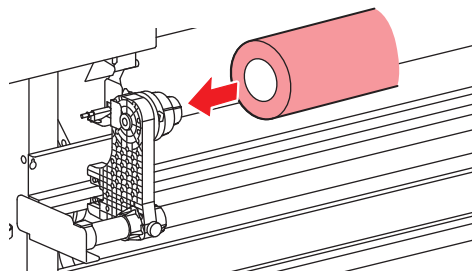

- 6 Insert the rear right roll holder into the paper core.

- Unscrew the roll holder retaining screw before moving.

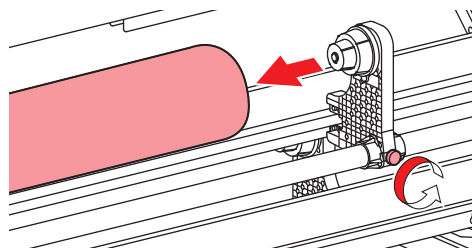

**7 Tighten the retaining screw on the rear right roll holder.**

**8 Insert the media.**

- Insert into the gap between the pinch rollers and the grit rollers.



- Inserting the media at an angle allows smooth insertion without catching or sticking.

**9 Lower the clamp lever.**

- Hold the media with the pinch roller and grit rollers.

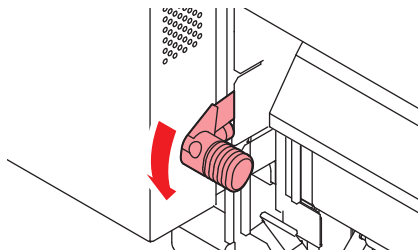

**10 Move to the front of the machine and open the front cover.**

**11 Raise the clamp lever and pull out the media.**

- Make sure the media does not fall to the rear.



- Adjust the rear roll holder position so that the media does not cover the right-hand slit line on the platen. Movement at an angle may result in damage to the print head.

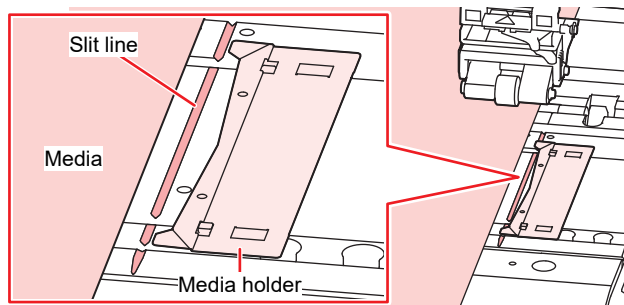

- The areas extending 5 mm from both sides of the media are margins.

**12 Lower the clamp lever to confirm that the spacing from the pinch roller is uniform.**

- ["Adjusting the Pinch Roller Positions"\(P. 54\)](#)

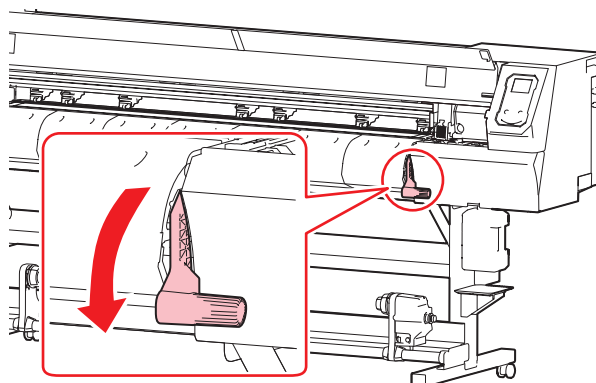



- If the spacing is not uniform, repeat all steps from the start.

### 13 Raise the clamp lever.

### 14 Gently pull out the media and stop at the position where it is gently locked in place.

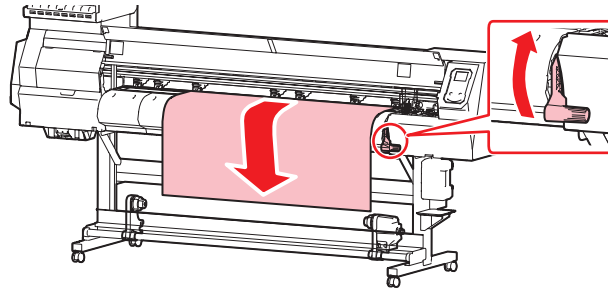

### 15 Check how far the media was pulled out.

- Pull the front edge of the media gently at several points to confirm that the media was pulled out by the same amount.

### 16 Lower the clamp lever.

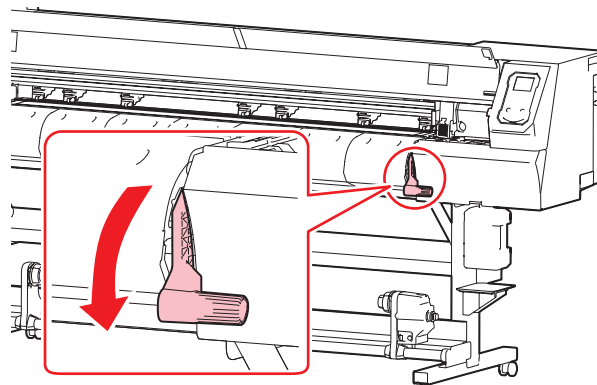

### 17 Secure the media in the media holder.

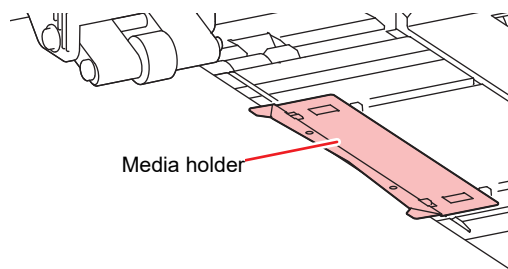

- Do not use the media holder when printing on thicker media.
- Do not use the media holder when cutting media.

### 18 Press , then select "Roll".

- This starts media width detection.
- If the setting for [Machine Setup] > [Media Detect] > [Detection Type] is "MANUAL", the area for printing must be determined manually.
- If the setting for [Machine Setup] > [Media Detect] > [Media Remain] is "ON", the media length input screen will be displayed.



- A notification reading "Media Set Position R" will appear after media width detection if the media is too far to the right of the specified position. Reload media in the specified position.

## 19 Enter the number of pinch rollers being used.

- If the setting for [Machine Setup] > [Media Detect] > [Use PR Number Query] is "OFF", the screen for entering the number of pinch rollers will be displayed.

## 20 Load an empty paper core on the take-up unit.

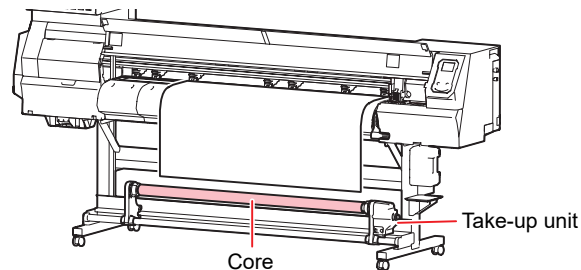

## 21 Secure the media to the take-up unit.

- (1) Press  to feed the media until it reaches the core on the take-up unit.
- (2) Secure the middle of the media with adhesive tape.
- (3) Secure the media on the right and left in the same way.
  - Pull the lower edge of the media evenly on both the left and right sides, check to confirm that it is free of sagging and creasing, then affix the tape.

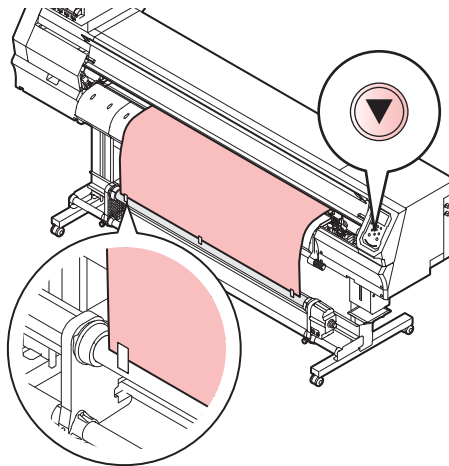

- Move the take-up unit to the left or right when it is not in use. Print quality may be affected if the front edge of the media hits the take-up unit.

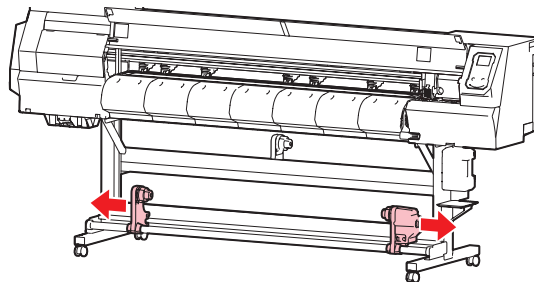



## Setting Leaf Media

The roll holder and the roll hanger are not used with leaf media.

### 1 Move the take-up units to left and right.

- Print quality may be affected if the front edge of the media hits the take-up unit during printing.

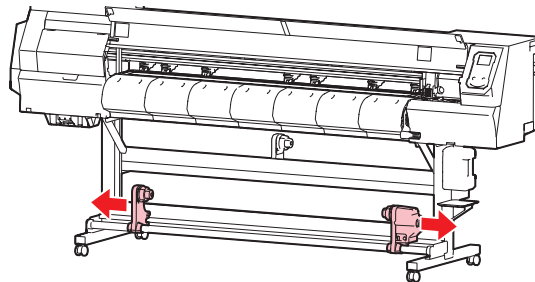

### 2 Raise the clamp lever.

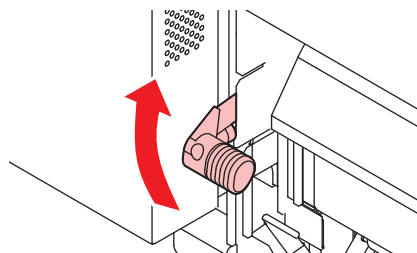

### 3 Open the front cover.

### 4 Insert the media.

- Insert into the gap between the pinch rollers and the grit rollers.



- Inserting the media at an angle allows smooth insertion without catching or sticking.

### 5 Adjust the position of the right media edge.

- Set the media straight so that the media does not lie beyond the slit line on the platen.

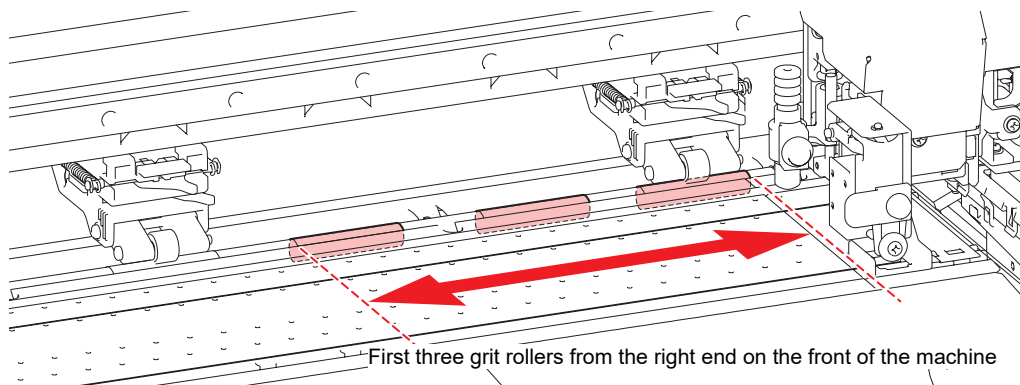

- The areas extending 5 mm from both sides of the media are margins.

## 6 Adjust the position of the front media edge.

- Set the media so that at least 40 mm of the media lies on the after cover. If not, the media width may not be detected.

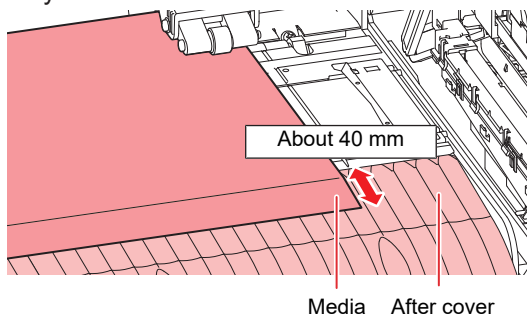

## 7 Lower the clamp lever to confirm that the spacing from the pinch roller is uniform.

- Hold the media with the pinch roller and grit rollers.
-  ["Adjusting the Pinch Roller Positions"\(P. 54\)](#)

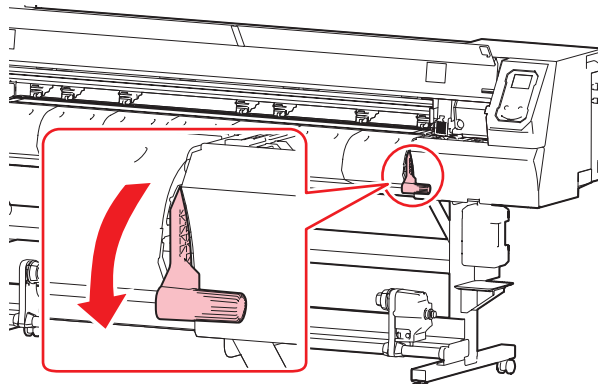

- If the spacing is not uniform, repeat all steps from the start.

## 8 Secure the media in the media holder.

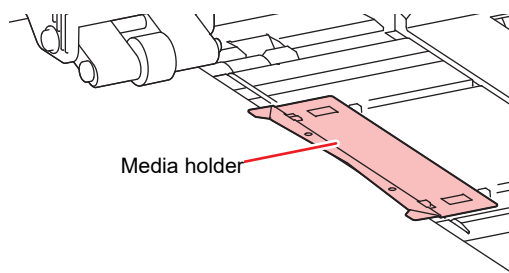

- Do not use the media holder when printing on thicker media.
- Do not use the media holder when cutting media.

## 9 Press and select [LEAF].

- After the media width is detected, the rear edge of the media is detected.
- If the setting for [Machine Setup] > [Media Detect] > [Detection Type] is "MANUAL", set the area for printing manually.



- A notification reading "Media Set Position R" will appear after media width detection if the media is too far to the right of the specified position. Reload media in the specified position.

**10 Enter the number of pinch rollers being used.**

- If the setting for [Machine Setup] > [Media Detect] > [Use PR Number Query] is "OFF", the screen for entering the number of pinch rollers will be displayed.

## 2.5 Setting the Pressure and Number of Pinch Rollers to Use

Set the pressure and number used to hold media based on the tool and media being used. Incorrect pinch roller pressure settings may result in media skew or leave pinch roller marks on the media.

- 1 On the LOCAL mode screen, select [PR].

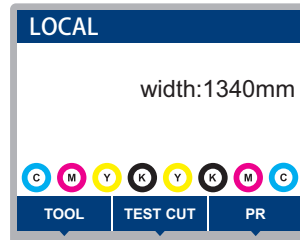

- 2 Make settings based on the tool and media used.

- The following items can be configured:
- The settings are retained even when the power is turned off.

Item	Setting	Overview
Number for Use	2 or more (depending on size)	Sets the number of pinch rollers to use.
Print	LOW/MID/HIGH	Sets the pressure used for printing.
Cut:Ends	LOW/MID/HIGH	Sets the pressure for both the pinch rollers on the edges (left and right) used for cutting.
Cut:Inner	OFF/LOW/MID/HIGH	Sets the pressure for the pinch rollers used for printing other than those on the edges.
Pullback setting: both ends	LOW/MID/HIGH	Sets the pressure for both pinch rollers on the edges (left and right) used for multilayer printing. The pinch rollers other than those on the edges are raised so that they leave no marks on the print surface. (This is supported in firmware version 2.5 and later.) This can be used only when printing with white ink and then with color and gloss. For more information refer to the RasterLink reference guide or the multilayer printing guide. <a href="https://mimaki.com/download/software.html">https://mimaki.com/download/software.html</a> <a href="https://mimaki.com/download/inkjet.html">https://mimaki.com/download/inkjet.html</a>
Switch operation	-	Used to check settings. Switch to configured settings before printing the built-in pattern (e.g., test printing, test cutting).

## 2.6 Test Printing

Print a test pattern to confirm that the ink prints correctly. Perform head cleaning if you observe any ejection failures (e.g., nozzle clogging or deflection). 🗨️ ["Head Cleaning"](#)(P. 71)

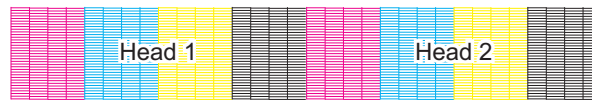

### Check beforehand

- Was the print head adjusted? 🗨️ ["Adjusting the Print Head Height."](#)(P. 53)
- Is media loaded? 🗨️ ["Loading the Media"](#)(P. 59)



- Load media at least 500 mm wide. You cannot print the entire pattern if media less than 500 mm wide is used.



- Select [Maintenance] > [Nozzle Recovery] > [Test Print], then select "ON" to perform nozzle recovery and test printing. (This feature is supported in firmware version 2.5 and later)  
Registration is required to perform nozzle recovery. 🗨️ ["Registering Nozzle Recovery"](#)(P. 116)

## Changing the Layout Direction for Test Printing

You can change the layout direction for test printing.

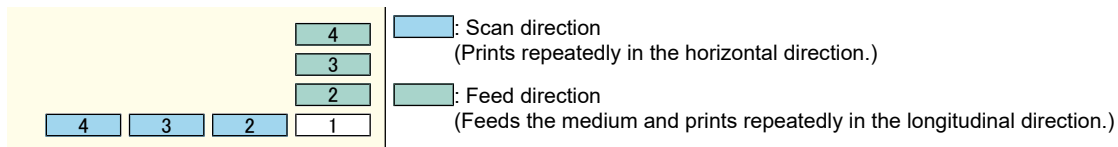

**1** On the LOCAL mode screen, select [TEST PRINT/CLEANING] > [Test Print], then press the [ENTER] key.

- The Test Print menu is displayed.

**2** Select [Scan Dir.] or [Feed Dir.], then press the [ENTER] key.

- Test printing starts.

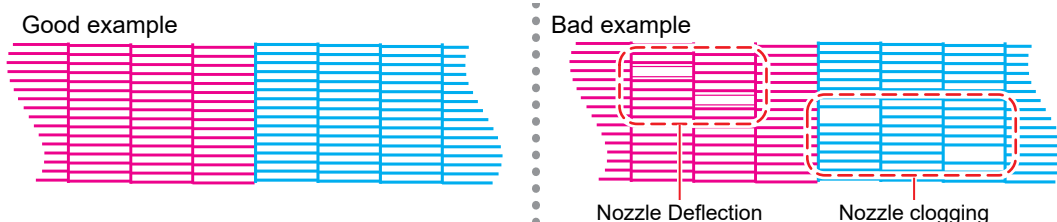

**3** Check the print results.

## Checking White Ink Ejection

The following two methods are available for checking white ink:

- Print on clear film.
- Print the background for the test pattern using black ink.

## ● Procedure for printing the background using black ink

- 1 On the LOCAL mode screen, select [TEST PRINT/CLEANING] > [Test Print], then press the [ENTER] key.
  - The Test Print menu is displayed.
- 2 Select [SpotColor Check], then press the [ENTER] key.
  - Test printing starts.
  - The layout direction is fixed at [Scan Dir.].

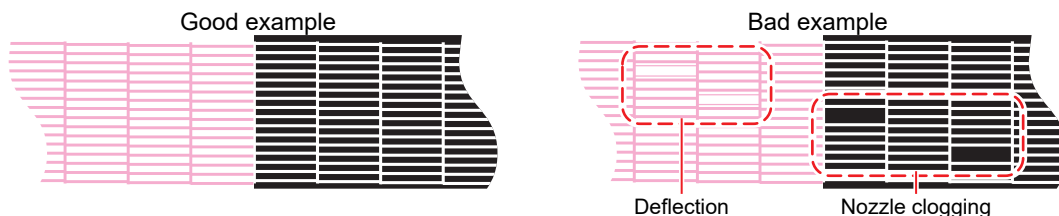

- 3 Check the print results.

## Ejection Failures

Typical examples of ejection failures (e.g., nozzle clogging, deflection) are as shown below. In order to prevent printing in such a state, check whether the ink has been properly ejected regularly before printing.

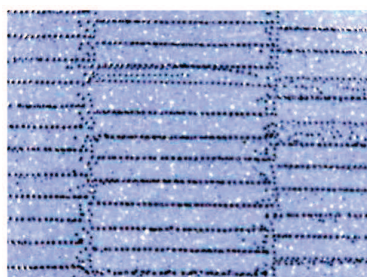

Nozzle Deflection

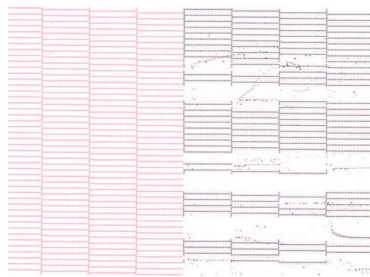

Nozzle clogging



Ink drips



Mist

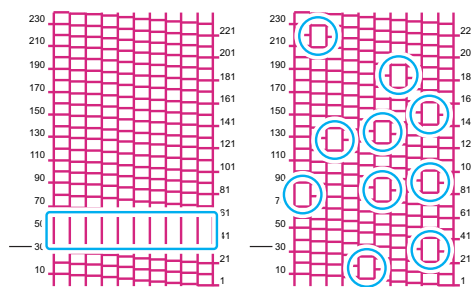

Mixed air

## 2.7 Head Cleaning

The following head cleaning methods are available. Choose the method based on test results.

Item	Details
Soft	If the print shows a bent line (nozzle deflection)
Normal	If the print shows a missing line (nozzle clogging)
Hard	If soft cleaning and normal cleaning fail to resolve ejection failures (e.g., nozzle clogging or deflection).
Ultra	If hard cleaning fails to resolve ejection failures (e.g., nozzle clogging or deflection) or color mixing



- Cleaning is not possible when [Ink Near End] or [Ink End] are displayed. Replace with new ink. ["Ink Replacement Method"\(P. 41\)](#)



- The ink used in this machine is warmed before printing. Note that printing and cleaning is disabled while the ink is being warmed.

- 1 On the LOCAL mode screen, select [TEST PRINT/CLEANING] > [Cleaning], then press the [ENTER] key.**
  - The Cleaning menu is displayed.
- 2 Select the cleaning type, then press the [ENTER] key.**
- 3 Select the Head to clean, then press the [ENTER] key.**
  - Check the check box. Heads with checked check boxes will be cleaned.
- 4 Run another test print and check the print results.**
  - Repeat the cleaning and test printing process until the print results appear normal.





- Do the following if head cleaning fails to resolve the ejection failures (e.g., nozzle clogging or deflection).
  - ["Wiper Cleaning"\(P. 134\)](#)
  - ["Cap Rubber Cleaning"\(P. 136\)](#)
  - ["Print Head Nozzle Washing"\(P. 163\)](#)

## 2.8 Feed Correction

Changing the media may affect the feed amount due to various factors, including the weight and thickness of the media and whether the take-up unit is used. Correct the drop position to suit the type of media used. Image defects (e.g., dark or light streaks) will result if the feed is not properly corrected.

### Check beforehand

- Is media loaded?  ["Loading the Media"\(P. 59\)](#)
- For roll media, is the rear roll media free of sagging?
- When using the take-up unit, was the media mounted on the paper core of the take-up unit?  ["Loading the Roll Media"\(P. 61\)](#)

### Feed Correction Procedure

Print a correction pattern, then enter the correction value. The value corrected here will also be updated on the settings menu.



- When using the take-up unit, load media on the take-up unit before correcting.

- 1 On the LOCAL mode screen, select [ADJUST].

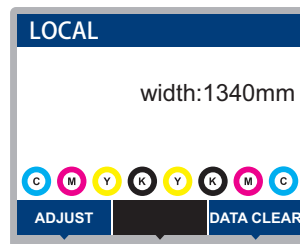

- 2 Select [Feed Comp.], then press the [ENTER] key.

- Correction pattern printing starts.

- 3 Check the print results.

- A correction value input screen appears.
- Adjust the bands so that the region between them is evenly colored.

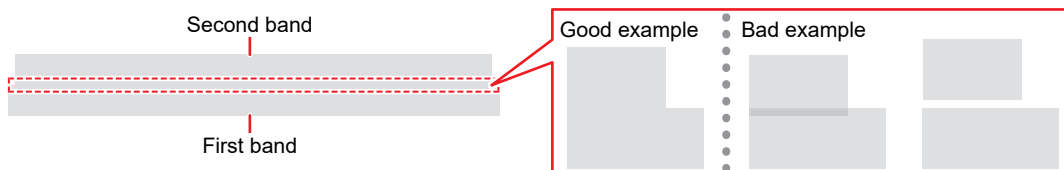

- 4 Enter the correction value, then press the [ENTER] key.

- "+" input: Increases the separation between bands.
- "-" input: Reduces the separation between bands.
- Increment the correction value by "30" to move the bands by approximately 0.1 mm.

- 5 Press the [ENTER] key.

- Print another correction pattern to check.





- Once adjustment is complete, the medium will be fed to the print origin. Sagging may occur in the rear roll medium. Rewind roll media by hand to eliminate any sagging.

---

## Correcting the Media Feed During Printing

---

You can also correct the media feed amount in REMOTE mode or while printing.

- 1** Press [ADJUST] in REMOTE mode or while printing.
- 2** Enter the correction value, then press the [ENTER] key.
  - Correction value: -9999 to 9999
  - The value entered here will be updated immediately.

## 2.9 Correcting the Drop Position

Changing the media and print head height will also alter the drop positions. Correct the drop position to suit the type of media used. Image defects (e.g., overlaid lines or blurred images) will result if the drop position is not properly corrected.

### Check beforehand

- Was the print head adjusted? 🛠️ ["Adjusting the Print Head Height."\(P. 53\)](#)
- Is media loaded? 🛠️ ["Loading the Media"\(P. 59\)](#)



- Load media at least 500 mm wide. You cannot print the entire pattern if media less than 500 mm wide is used.

### Drop Position Correction Procedure

Print a correction pattern, then enter the correction value. The value corrected here will also be updated on the settings menu.

- 1 On the LOCAL mode screen, select [ADJUST].

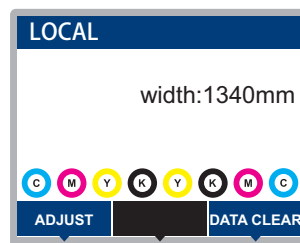

- 2 Select [Drop.PosCorrect], then press the [ENTER] key.

- Correction patterns for all resolutions will be printed.

- 3 Check the print results.

- A correction value input screen appears.
- Enter the position where the two upper and lower lines coincide.

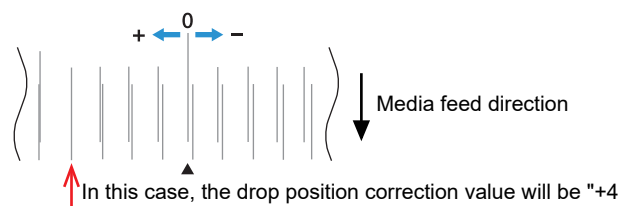

- 4 Enter the correction value, then press the [ENTER] key.

- Correction value: -40 to 40



- If the lines do not coincide when the correction value is within the range -40 to 40, the print head height may have been improperly adjusted. Adjust the print head height. 🛠️ ["Adjusting the Print Head Height."\(P. 53\)](#)

- 5 Enter the correction value in the same way for pattern 2 and subsequent patterns.

## 2.10 Preparing RIP data

The explanation here applies to MIMAKI RIP software (RasterLink).



- Prepare suitable image data for printing.

### 1 Launch RasterLink.

- Click the icon on the PC desktop.



### 2 Select the image data to print.

- (1) Select [File] > [Open].
- (2) Select the desired image data, then click [Open].
  - If multiple printers are registered, select UCJV300 Series, 150 Series in "Printer Name".

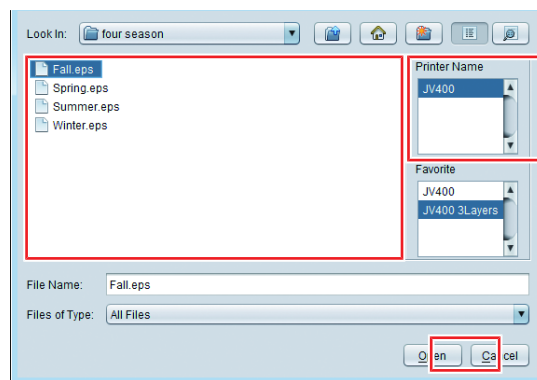

### 3 Select the image data imported.

- The image is displayed in the tab for UCJV300 Series, 150 Series selected in "Printer name".

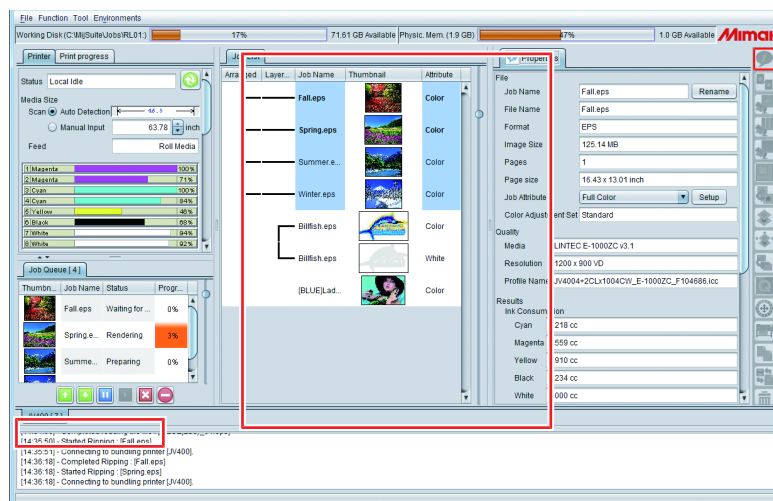

### 4 Check the settings and alter as necessary.

- Specify the following settings by clicking the function icons shown on the right-hand side of the screen:



(normal printing): Specifies settings like enlargement/reduction and number of copies.



(print conditions): Selects a color profile for the media and ink set loaded in this machine.



- For more information, refer to the RasterLink reference guide. <https://mimaki.com/download/software.html>
- 

## 5 Print image data.

- Click  (execute) from the function icons on the right-hand side of the screen. Select "Immediate Print" or "RIP and Print", then click [Start].
- 



- Media width must be reacquired after replacing media.
    - (1) Select the tab for UCJV300 Series, 150 Series in the main window.
    - (2) Click  (Update the printer status) in the Printer tab.
-

## 2.11 Printing

### Check beforehand

- Was the head gap adjusted? 🧠 "Adjusting the Print Head Height."(P. 53)
- Were the pinch roller positions adjusted? 🧠 "Adjusting the Pinch Roller Positions"(P. 54)
- Is media loaded? 🧠 "Loading the Media"(P. 59)
- Was the pinch roller pressure adjusted? 🧠 "Setting the Pressure and Number of Pinch Rollers to Use"(P. 68)
- For roll media, is the rear roll media free of sagging?
- When using the take-up unit, was the media mounted on the paper core of the take-up unit? 🧠 "Loading the Roll Media"(P. 61)

### Changing the Origin

The print start position can be altered. Use the LED pointer to set the origin.

- Print origin default value
  - Feed (longitudinal, X') direction: Approx. 75 mm to rear from platen cutting slot
  - Scan (lateral, Y') direction: 15 mm from right edge of media

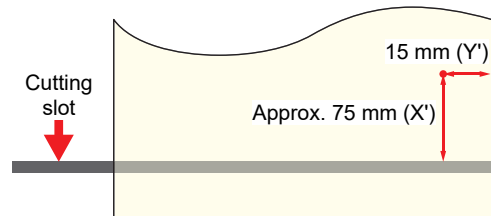

- 1 On the LOCAL mode screen, press ▲▼◀▶.**
  - The Origin Setup screen appears.
- 2 Press ▲▼◀▶ to move the origin to the desired position.**
  - The carriage moves left and right and feeds the medium.
- 3 Press the [ENTER] key.**
  - The origin is updated.

### Starting Printing

- 1 Press [REMOTE].**
  - The machine switches to REMOTE mode and is ready for printing.
- 2 Send the RIP data from the PC.**
  - 🧠 "Preparing RIP data"(P. 75)



- If an error message appears, check appropriate actions by referring to the error number. Error messages

### 3 Start printing.

- Printing starts once RIP data is received.

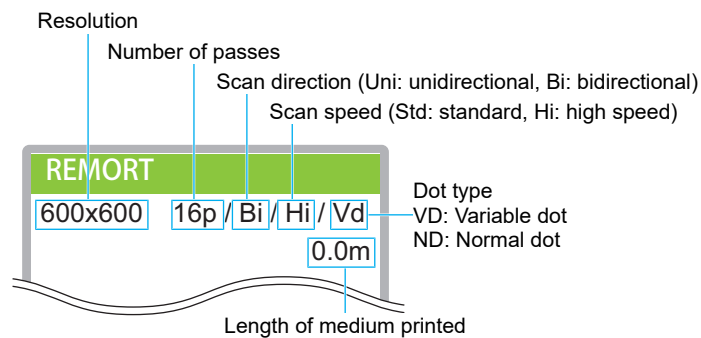

- Print speeds may differ for the same image data, depending on the width of the medium loaded, print origin position, and resolution.
- If an error occurs, the machine switches to LOCAL mode once printing is completed. Further printing is not possible.

## Pausing Printing

### 1 Press [LOCAL] while printing is in progress.

- Printing is paused.
- If data is being sent from a PC, data transmission is paused at the PC.

### 2 Press [REMOTE].

- Printing resumes.



- No other functions can be used when printing is paused.

## Stopping Printing (Data Clear)

### 1 On the LOCAL mode screen, select [DATA CLEAR].

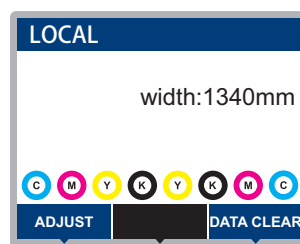

### 2 Press the [ENTER] key to clear the received data.

- The receive buffer is cleared.

## 2.12 Cutting the media

- 1** On the LOCAL mode screen, press ▲▼◀▶.
  - The Origin Setup screen appears.
- 2** Press ▲▼ to feed the media to the position required for cutting.
- 3** Select [CUT], then press the [ENTER] key.
  - The media is cut.

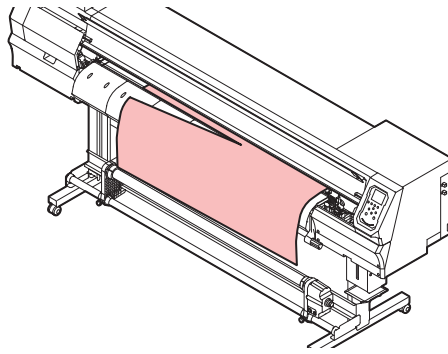





# Chapter 3 Cutting

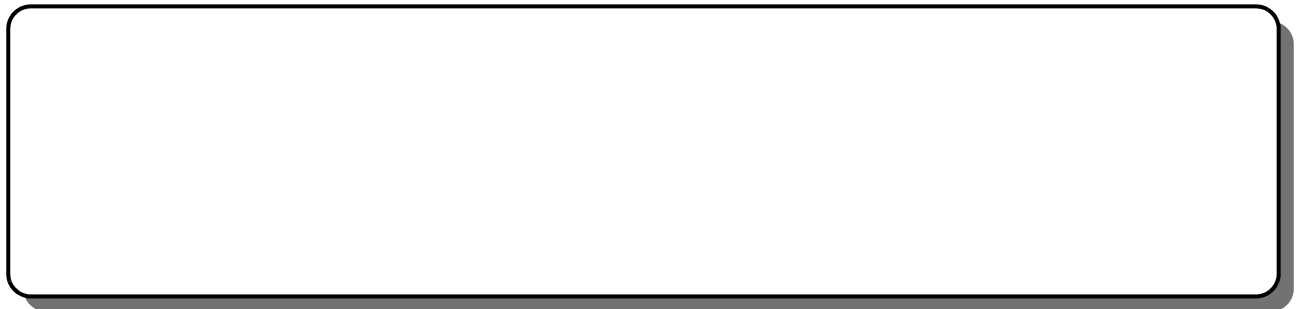

Cutting Process .....	82	Test Cutting .....	93
Installing Cutting Tools .....	84	Cutting the Cutting Data .....	94
Using the Cutter .....	84	Changing the Origin .....	94
Using a Pen.....	88	Starting Cutting .....	94
Setting the Cutting Conditions.....	92	Stopping Cutting (Data Clear).....	95
		Retracting the Cutter Unit .....	95

## 3.1 Cutting Process

### 1. Turn on the power.

 ["Turning On the Power"\(P. 33\)](#)

### 2. Connect this machine to the PC on which the cutting software is installed.

 ["Using a USB Cable"\(P. 35\)](#)

 ["Using a LAN Cable"\(P. 35\)](#)

### 3. Adjust the pinch roller positions.

Adjust the pinch roller positions to suit the width of the set media. Adjust the pinch roller positions so that the pinch rollers are positioned above the grit rollers. The pinch rollers at both ends should be aligned to within 10 cm from the left edges and 2 cm from the right edges of the media.  ["Adjusting the Pinch Roller Positions"\(P. 54\)](#)

### 4. Loading the media

This machine can be used with roll media and leaf media.  ["Loading the Media"\(P. 59\)](#)

### 5. Adjust the number and pressure of pinch rollers to use.

Set an appropriate pressure for the set media.  ["Setting the Pressure and Number of Pinch Rollers to Use"\(P. 68\)](#)

### 6. Install the cutting tools.

This machine can be used with a cutter and a pen (ballpoint pen).  ["Installing Cutting Tools"\(P. 84\)](#)

### 7. Set the cutting speed and pressure.

Set the cutting speed and pressure to match the type of media and tools in use. Setting the Cutting Conditions

### 8. Perform test cutting.

Perform a test cut to confirm that the tool conditions are set appropriately.  ["Test Cutting"\(P. 93\)](#)

## 9. Cutting the Cutting Data



👉 "Cutting the Cutting Data"(P. 94)

## 10. Cutting the media

👉 "Cutting the media"(P. 79)

## 3.2 Installing Cutting Tools

This machine can be used with the following tools:

- Cutter (for cutting media)  
Used to cut the printed image on media or to cut characters with the cutting sheet  
 "Using the Cutter"(P. 84)
- Pen (ballpoint pen)  
Used to adjust register marks This machine can be used with a ballpoint pen or cartridge refill.  
 "Using a Pen"(P. 88)

### Using the Cutter

#### Installing the Cutter in the Cutter Holder

Be careful to keep the cutter from falling into a gap in this machine. We recommend replacing the cutter on the media so you can easily pick up the cutter blade if it falls.



- Avoid touching the cutter blade. Failure to do so may result in injury.
- Do not shake or swing the cutter holder. Doing so may cause the blade to come off.



- Avoid storing this product in locations accessible to children.



- When disposing of the product, contact an industrial waste disposal operator or dispose of the product in accordance with the local laws and regulations.

#### 1 Remove the cap from the cutter holder.

- Turn in the direction indicated by the arrow in the picture.

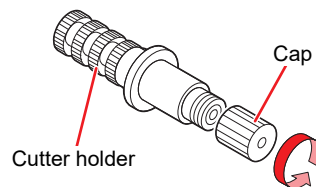

#### 2 Insert the cutter into the cutter holder.

- Use tweezers to insert the cutter.

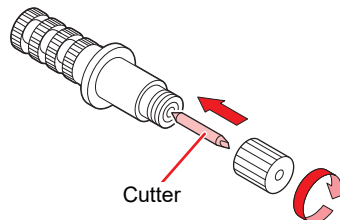

#### 3 Fix the cap by turning in the direction indicated by the arrow in the picture.

#### Adjusting the Cutting Blade Protrusion Length

Adjust the cutting blade protrusion length (0.2 to 0.5 mm).

- If the base paper is thicker than the label film:  $(\text{label film thickness} + \text{base paper thickness})/2$

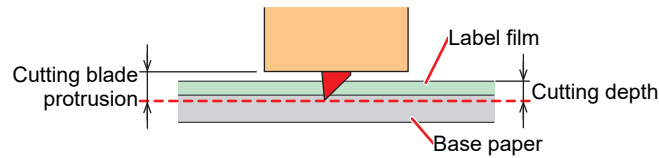

- If the base paper is thinner than the label film: As far as to cut into label film

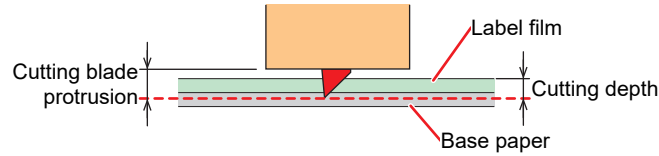

- An option is available to accurately adjust the protrusion amount of the blade tip.  
Part number: OPT-C0066 "blade adjuster (for eccentric cutter)"

## 1 Turn the adjusting knob to adjust the protrusion of the cutting blade.

- Turn the adjusting knob in the direction indicated by the arrow in the picture to have the blade protrude. (0.5 mm per turn)

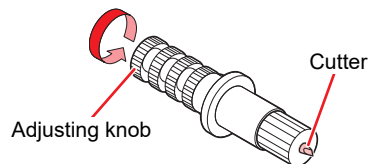

## 2 Check the cutting performance.

- Adjust the pressure so that it leaves slight marks on the base paper. A cutting blade that protrudes too far may damage the machine.  
☞ "Setting the Cutting Conditions"(P. 92)  
☞ "Test Cutting"(P. 93)



- When using the cutter holder included in the delivery, you can adjust the protrusion length while the cutter is attached to the tool holder. (0.5 mm per turn of the adjusting knob)

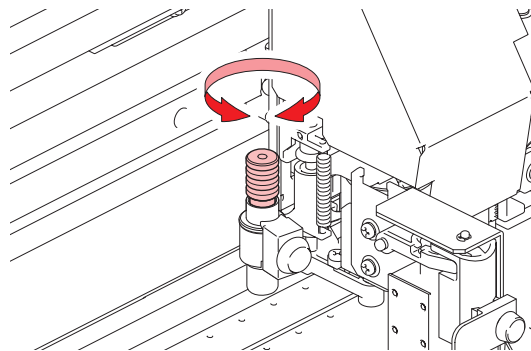

## Installing the Cutter Holder

### 1 On the LOCAL mode screen, select [MENU] > [Cutting], then press the [ENTER] key.

- The Cutting menu is displayed.

### 2 Select [Tool Change], then press the [ENTER] key.

- The cutter unit moves to the maintenance space.

### 3 Open the maintenance covers.

- The cutter unit can be moved manually. Move the cutter unit slowly to a position that allows easy access for replacing and installing the cutter holder.

### 4 Turn the knob screw and loosen the holder presser.

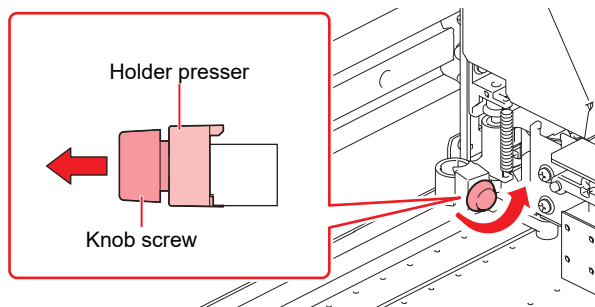

### 5 Insert the cutter holder into the tool holder.

- (1) Push the brim of the cutter holder against the tool holder.
- (2) Put the brim of the cutter holder into the tool holder.

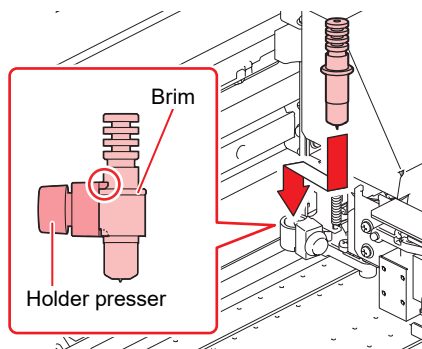

### 6 Secure the cutter holder.

- Turn the knob screw and fix the holder presser.
- Failure to secure firmly may result in lower quality.

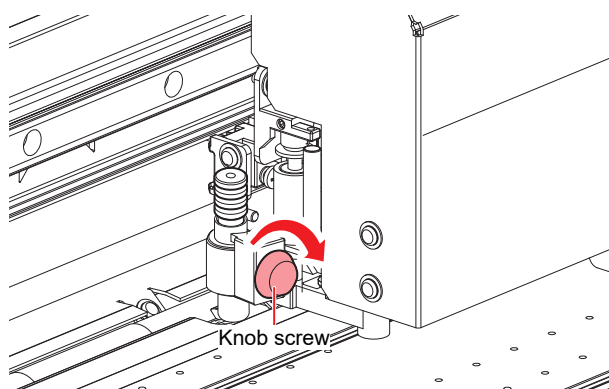

### 7 Press the [ENTER] key once installation is complete.

### 8 Close the maintenance covers.

## Using the Included Cutter Holder (SPA-0001)

### 1 Loosen the lock nut of the cutter holder and extract the adjusting knob.

- Turn in the direction indicated by the arrow in the picture.

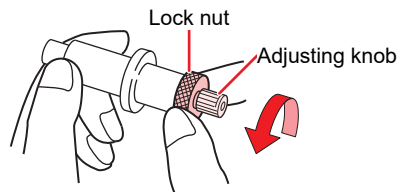

### 2 Insert the cutter into the adjusting knob.

- Use tweezers to insert the cutter.

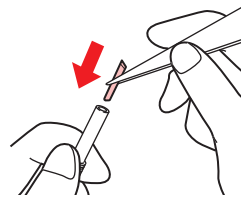

### 3 Fix the lock nut by turning in the direction indicated by the arrow in the picture.

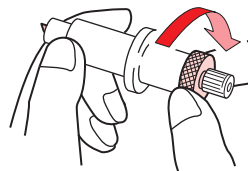

## Adjusting the Cutting Blade Protrusion Length

### 1 Loosen the lock nut of the cutter holder.

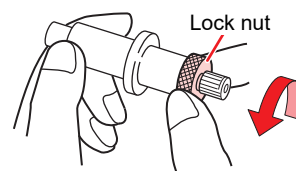

### 2 Turn the adjusting knob to adjust the protrusion of the cutting blade.



### 3 Fix the lock nut by turning in the direction indicated by the arrow in the picture.

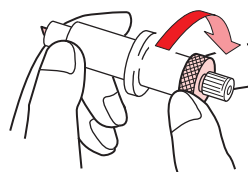

## Using a Pen

### Installing a Refill Cartridge for a Ballpoint Pen in the Pen Holder

The image quality can vary depending on the type of refill cartridge.  
Recommended: SXR-5 (Mitsubishi Pencil Co., Ltd.)

#### 1 Remove the cap from the pen holder.

- Turn in the direction indicated by the arrow in the picture.

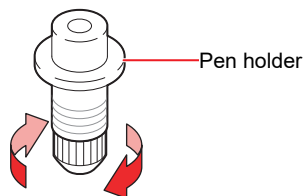

#### 2 Insert a refill cartridge into the pen holder.

- Insert the refill cartridge until it hits the pen holder.

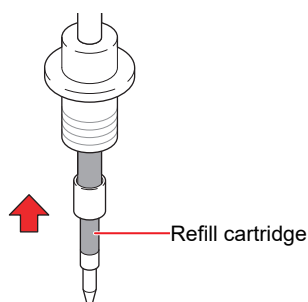

#### 3 Insert the spring into the refill cartridge.

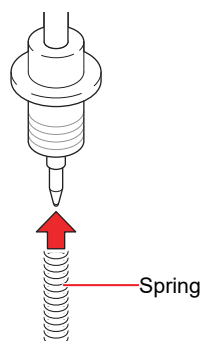

#### 4 Fix the cap by turning in the direction indicated by the arrow in the picture.

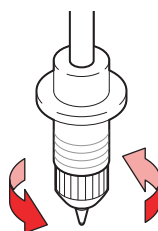

### Installing a Ballpoint Pen in the Pen Adapter

Use a ballpoint pen with a diameter of 8 to 9 mm. The ballpoint pen type may affect image quality.  
Recommended: K105-GA (Pentel Co., Ltd.)





- Do not use ballpoint pens as shown below. Some types of ballpoint pens may tilt.



Pens with shafts that change thickness midway

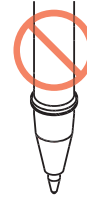

Pens with protrusions or bumps on the shaft

## 1 Put the cap on the pen adapter.

- The cap is used to adjust the height of the pen nib.

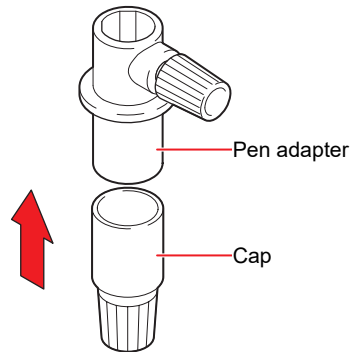

## 2 Insert the ballpoint pen into the pen adapter.

- Insert the pen nib until it hits the cap.

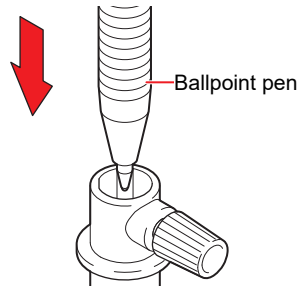

## 3 Fix the pen nib by turning the knob screw in the direction indicated by the arrow in the picture.

- Be careful to avoid overtightening the knob screw. Disregarding this precaution may damage or break the ballpoint pen.

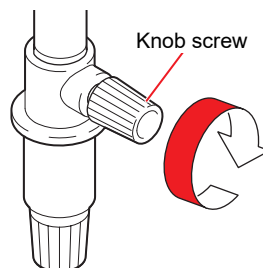

## 4 Remove the cap.

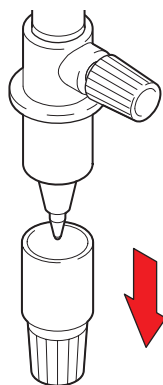

## Installing a Pen

### 1 On the LOCAL mode screen, select [MENU] > [Cutting], then press the [ENTER] key.

- The Cutting menu is displayed.

### 2 Select [Tool Change], then press the [ENTER] key.

- The cutter unit moves to the maintenance space.

### 3 Open the maintenance covers.

- The cutter unit can be moved manually. Move the cutter unit slowly to a position that allows easy access for replacing and installing the cutter holder.

### 4 Turn the knob screw and loosen the holder presser.

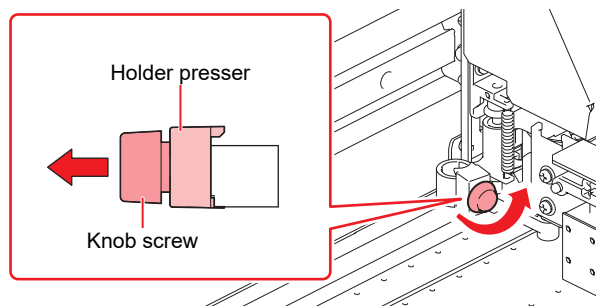

### 5 Insert the pen holder or pen adapter into the tool holder.

- (1) Push the brim of the pen holder or pen adapter against the tool holder.
  - Position the pen adapter so that the knob screw is easily accessible.
- (2) Push the brim of the pen holder or pen adapter against the holder presser.

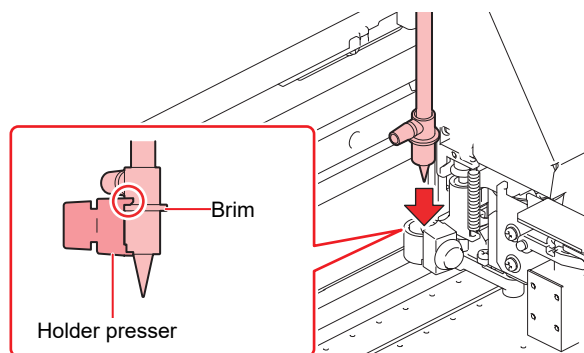

- 6 Secure the pen holder or pen adapter.**
  - Turn the knob screw and fix the holder presser.
  - Failure to fix securely may result in lower quality.
- 7 Press the [ENTER] key once installation is complete.**
- 8 Close the maintenance covers.**

## 3.3 Setting the Cutting Conditions

You can set the cutting speed and pressure to match the type of media and tools in use.

### 1 On the LOCAL mode screen, select [TOOL].

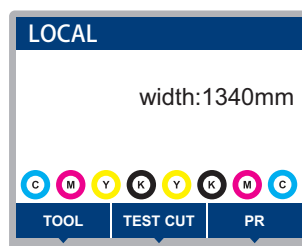

### 2 Set the conditions.

- The following items can be configured:
- The settings are retained even when the power is turned off.

Item	Setting	Overview
TOOL	CUT1 to 7/ PEN	<ul style="list-style-type: none"> <li>• Press the key repeatedly to change the tool condition in the sequence shown below.</li> </ul>
Speed	1 to 20cm/s	<ul style="list-style-type: none"> <li>• Sets the speed for cutting or pen writing.</li> </ul>
Pressure	TOOL: 10 to 450g PEN: 10 to 150g	<ul style="list-style-type: none"> <li>• Sets the pressure for cutting or pen writing.</li> <li>• This setting is also required for half cuts.</li> </ul>
Offset <sup>*1</sup>	0.00 to 2.50 mm	<ul style="list-style-type: none"> <li>• Sets the length from the center of the cutter holder to the cutting blade.</li> </ul>
Half Cut <sup>*1</sup>	ON/OFF	<ul style="list-style-type: none"> <li>• Cuts across a dotted line without cutting out the base paper.</li> </ul> <ul style="list-style-type: none"> <li>• If Half Cut is set to "ON", the three items listed below are displayed: Set the following three items and pressure in the Cutting Conditions menu:</li> </ul>
Half Cut Pressure	0 to 300g	<ul style="list-style-type: none"> <li>• Sets the pressure for the uncut portion.</li> </ul>
H-Leng	0.1 to 5.0 mm	<ul style="list-style-type: none"> <li>• Sets the uncut length.</li> </ul>
C-Leng	5 to 150 mm	<ul style="list-style-type: none"> <li>• Sets the cut length.</li> </ul>

1. This cannot be set when PEN is selected.

## 3.4 Test Cutting

Execute test cutting to confirm that the tool conditions are set appropriately.

Increase pressure as the cutter blade grows dull with wear. This is only a temporary measure. We recommend replacing the cutter blade to maintain cutting quality.

- 1 On the LOCAL mode screen, select [TEST CUT].

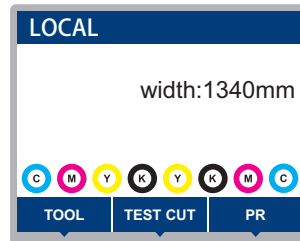

- 2 Select [Test Cut], then press the [ENTER] key.

- Test cutting starts.

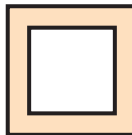





- Check the test cut results, and change the cutting conditions accordingly.

Symptom	Cause	Solution
An uncut section was identified.	<ul style="list-style-type: none"> <li>• Because the speed is too high, the cutting blade passed over the media.</li> </ul>	<ul style="list-style-type: none"> <li>• Reduce the [Speed]. ☞ "Setting the Cutting Conditions"(P. 92)</li> <li>• Tighten the knob on the tool holder. ☞ "Installing the Cutter Holder"(P. 85)</li> </ul>
The base paper of the media is cut.	<ul style="list-style-type: none"> <li>• The pressure is excessive.</li> <li>• The cutting blade protrudes too far.</li> </ul>	<ul style="list-style-type: none"> <li>• Reduce the [Pressure]. ☞ "Setting the Cutting Conditions"(P. 92)</li> <li>• Reduce the protrusion of the cutting blade. ☞ "Adjusting the Cutting Blade Protrusion Length"(P. 84)</li> </ul>
The corners are rounded.	<ul style="list-style-type: none"> <li>• The length from the center of the cutter holder to the cutting blade is not set correctly.</li> </ul>	<ul style="list-style-type: none"> <li>• Adjust the [Offset] value according to the cutter used. ☞ "Setting the Cutting Conditions"(P. 92)</li> </ul>
The corners are turned up.	Two or more of the following apply: <ul style="list-style-type: none"> <li>• The cutting blade protrudes too far.</li> <li>• The pressure is excessive.</li> <li>• The [MENU] &gt; [Cutting] &gt; [Setup Sub Menu] &gt; [Adj-prs Offset] value is large.</li> </ul>	<ul style="list-style-type: none"> <li>• Reduce the protrusion of the cutting blade. ☞ "Adjusting the Cutting Blade Protrusion Length"(P. 84)</li> <li>• Reduce the [Pressure]. ☞ "Setting the Cutting Conditions"(P. 92)</li> <li>• Reduce the [Adj-prs Offset] value. ☞ "Cutting Menu"(P. 125)</li> </ul>

## 3.5 Cutting the Cutting Data

### Check beforehand







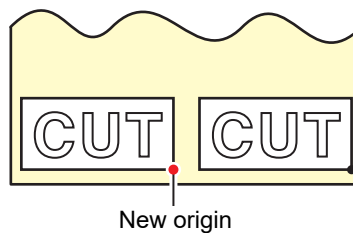

- Was the head gap adjusted?  "Adjusting the Print Head Height."(P. 53)
- Were the pinch roller positions adjusted?  "Adjusting the Pinch Roller Positions"(P. 54)
- Is media loaded?  "Loading the Media"(P. 59)
- Are the pinch rollers configured?  "Setting the Pressure and Number of Pinch Rollers to Use"(P. 68)

### Changing the Origin

You can change the cutting start position. Use the LED pointer to set the origin. The origin set here will be the origin of the cutting software you are using.

When cutting the same data again, change the origin. If not, cutting starts at the same position.



- 1 On the LOCAL mode screen, press    .
  - The Origin Setup screen appears.
- 2 Press     to move the origin to the desired position.
  - The carriage moves left and right and feeds the medium.
- 3 Press the [ENTER] key.
  - The origin is updated.
  - The set tool conditions are displayed on the display.

### Starting Cutting

- 1 Press [REMOTE].
  - The machine switches to REMOTE mode and is ready for cutting.
- 2 Send the cutting data from the PC.



- For more information, refer to the operation manual of the cutting software you are using.

- 3 Cutting starts.
  - Cutting starts once the cutting data is received.
  - The remaining amount of data is displayed on the display.



- If the media moves out of place during cutting, immediately turn off the power. Continuing to cut while the media is not in place may damage the machine.

## Pausing Cutting

- 1 Press [LOCAL] while cutting is in progress.
  - Cutting is paused.
  - If data is being sent from a PC, data transmission is paused at the PC.

- 2 Press [REMOTE].

- Cutting resumes.



- No other functions can be executed while printing is paused.

## Stopping Cutting (Data Clear)

- 1 On the LOCAL mode screen, select [DATA CLEAR].

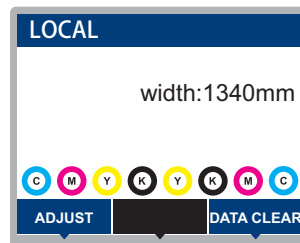

- 2 Press the [ENTER] key to clear the received data.

- The receive buffer is not cleared.

## Retracting the Cutter Unit

When cutting or printing-with-a-pen is completed, the cutter unit is positioned on the platen. To check the cutting result or to set new media, retract the cutter unit from the platen.

- 1 On the LOCAL mode screen, select [TEST CUT].

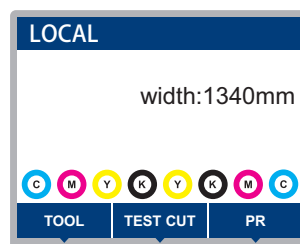

- 2 Select [Cut Head Move/Retract], then press the [ENTER] key.

- The cutter unit moves to the maintenance space on the left side.
- When the connecting unit is connected to the carriage, confirm the connection before moving the cutter unit to the origin. (Cutter unit moves)





# Chapter 4 Cutting Data with Register Marks

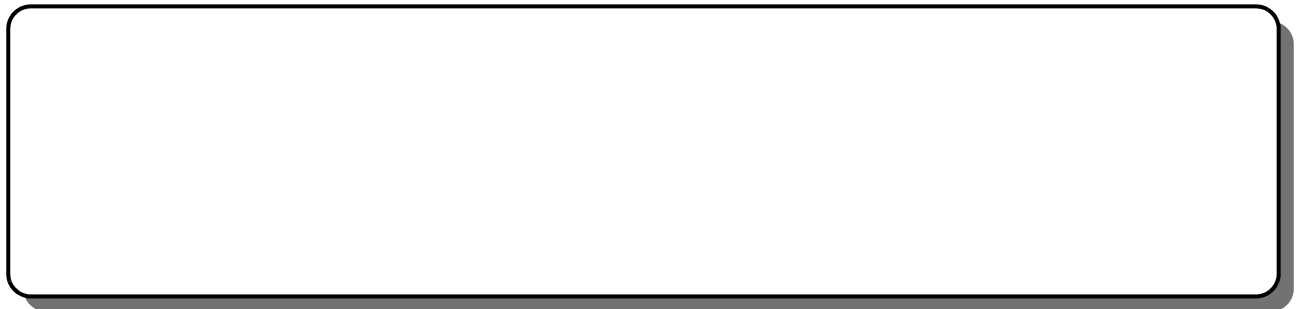

Process for Cutting Data with Register Marks.....	98	Setting Mark Detection Conditions.....	105
Creating Register Marks.....	100	Detecting the Position of the Register Mark	
Register Marks.....	100	Origin.....	106
Register Mark Size.....	101	ID Cut Process.....	107
Spacing Between Register Marks.....	102		
Reading Range of Register Marks.....	103		
No-Plotting Areas Around Register Marks	104		
Combined Operations of Printing and Cutting			
.....	104		

# 4.1 Process for Cutting Data with Register Marks

## 1. Create data with register marks.

 ["Creating Register Marks"\(P. 100\)](#)

This machine can detect the following three types of register marks:

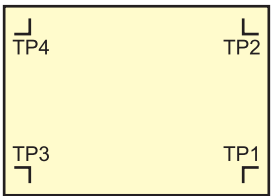
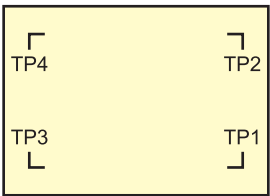
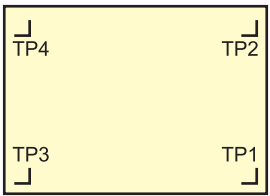
Type 1	Type 2	Zero margin register mark
		

## 2. Print printing data with register marks.

 ["Print Process"\(P. 50\)](#)

## 3. Prepare for cutting.

 ["Cutting Process"\(P. 82\)](#) (Steps 4 to 8)

## 4. Register the information for the printed register marks.

 ["Setting Mark Detection Conditions"\(P. 105\)](#)

## 5. Detect the register mark origin.

 ["Detecting the Position of the Register Mark Origin"\(P. 106\)](#)

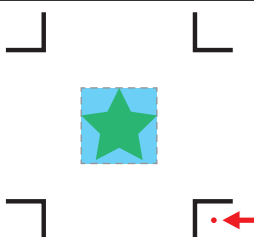
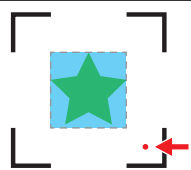
(Mark shape) Type 1	(Mark shape) Type 2
	

## 6. Cut the data.

 ["Cutting the Cutting Data"\(P. 94\)](#)

## 7. Cutting the media

 ["Cutting the media"\(P. 79\)](#)

## 4.2 Creating Register Marks

Printing image data with "register marks" can increase cutting accuracy and quality. There are some limitations to register marks. Read the following thoroughly before creating register marks.



- Trimming register marks cannot be used with the machine.

### Register Marks

The following three types of register marks can be used with this machine:

Type 1	Type 2	Zero margin register mark



- Use mark 4 (TP4) to perform trapezoidal corrections. Mark 4 can be skipped, but doing so will reduce cutting accuracy.  
Trapezoidal correction: Corrects the difference between the right and left feed amount of the media.

### Media and Register Mark Color

We recommend using white media and black register marks. The machine may fail to detect register marks in other colors.

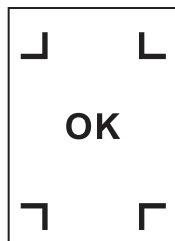

### Blurred Register Marks

Ensure that printed register marks are not blurred. If the register marks are blurred, the mark origins may be incorrectly identified, or the machine may fail to detect the register marks.



## Register Mark Size

The recommended register mark size (A) is within the range of A4 size (210 mm × 297 mm) to A3 size (297 mm × 420 mm). If the dimensions exceed A3, the machine may fail to detect register marks due to media feeding problems (e.g., media meandering).

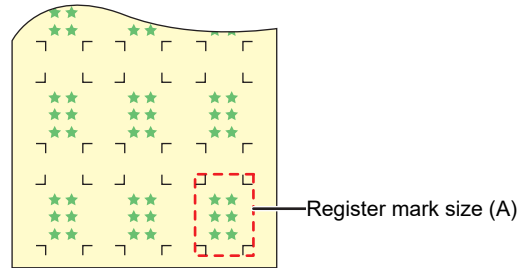

## Standards for Register Mark Length and Line Width

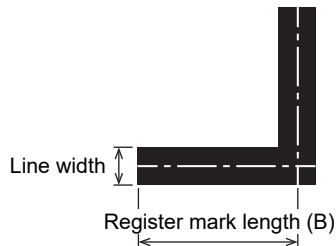

The recommended register mark length and line width are as shown below. The machine may fail to detect register marks that lie outside the recommended range.

Register mark size (A)	Register mark length (B)	Line width
200 mm or less	5 mm	0.5 mm
201 to 500 mm	8 mm	
501 to 1,000 mm	15 mm	1.0 mm
1,001 to 2,000 mm	25 mm	
2,001 mm or more	35 mm	

- If the "Fill around the registration marks" function of the RIP software is enabled, the register mark length (B) should be 10 mm or more.

## When Printing Register Marks Continuously

The register mark length (B) should be 8 mm or more. The machine may fail to detect register marks less than 8 mm if it reads them continuously.

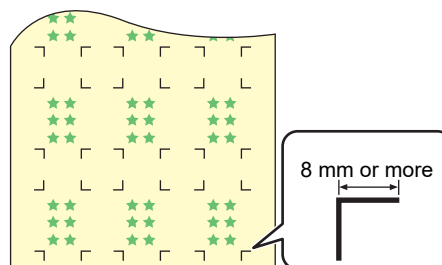

## Spacing Between Register Marks

The spacing between register marks (C) is as shown below.

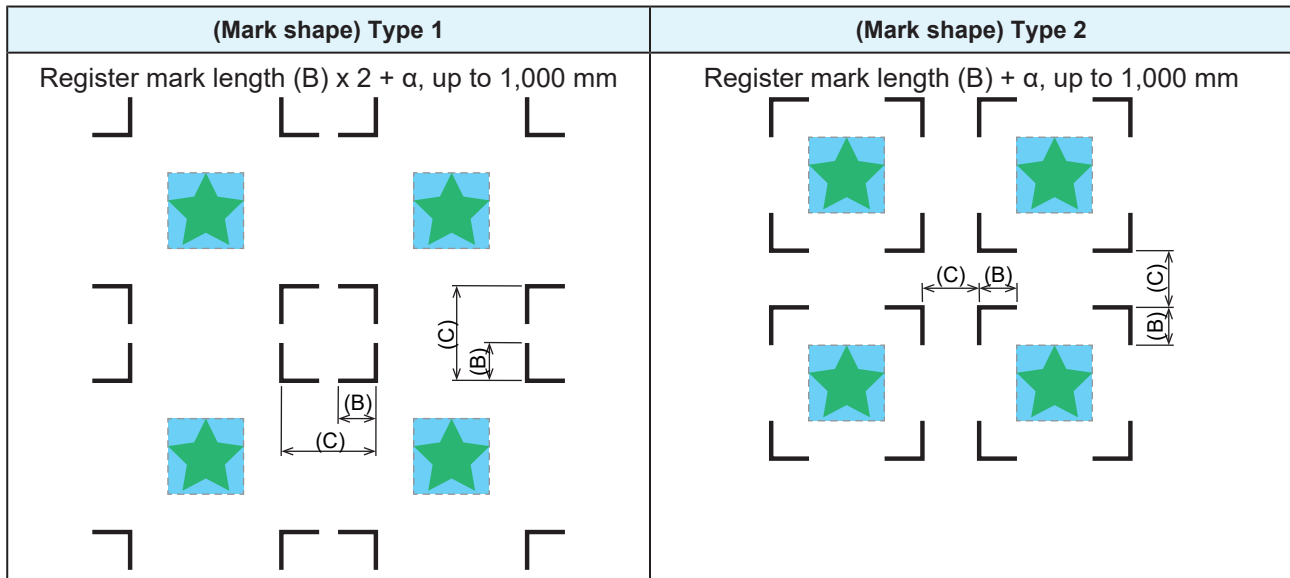

### ● Mark Origin Mis-detection Example

- If the spacing between register marks (C) is narrow, as shown in the figure below, the machine may fail to detect them.

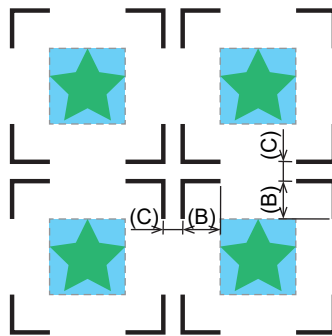

## Reading Range of Register Marks

This machine can detect register marks in the range shown below. If the margin is small, the edge of the media may be incorrectly identified as a register mark.

When copying data with MIMAKI RIP software (RasterLink), leave a space of at least 210 mm from the rear edge of the media.

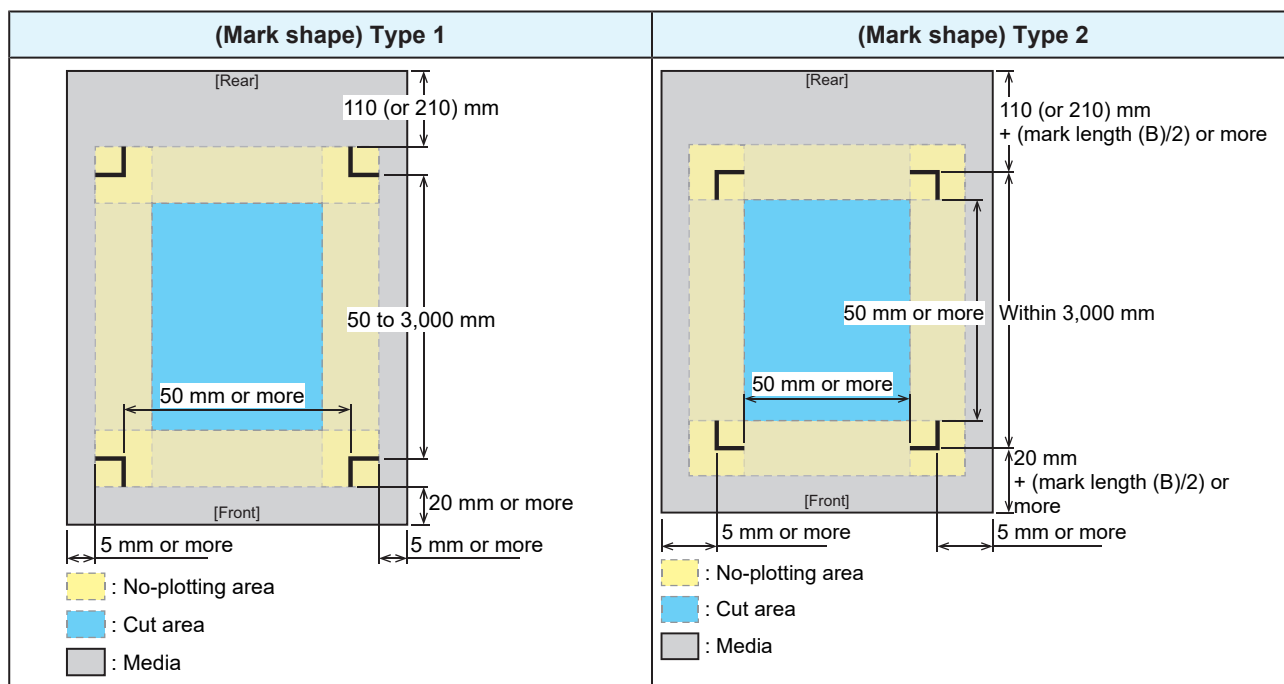

## ID Cut

This machine can detect register marks in the range shown below. If the margin is small, the edge of the media may be incorrectly identified as a register mark.

When copying data with MIMAKI RIP software (RasterLink), leave a space of at least 210 mm from the rear edge of the media.

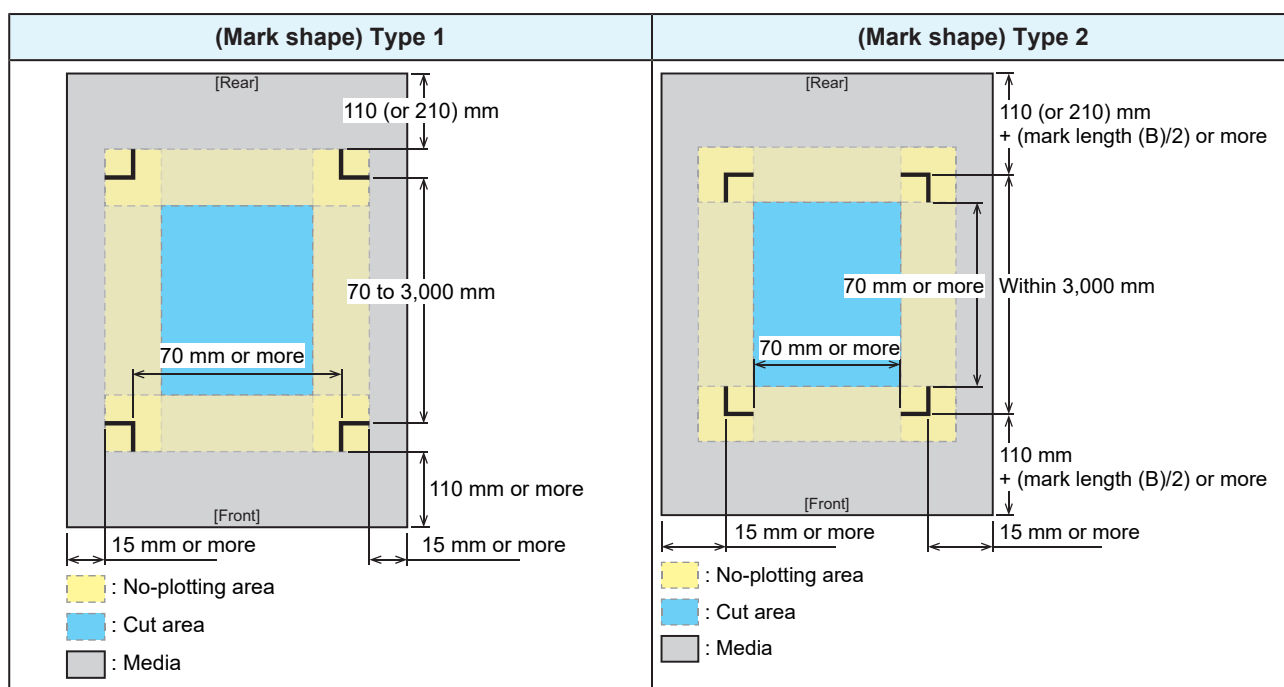

- For more information, refer to the ID Cut Guide. <https://mimaki.com/download/software.html>

## No-Plotting Areas Around Register Marks

Do not plot data around register marks. The mark origins may be identified incorrectly, or the machine may fail to detect the register marks.

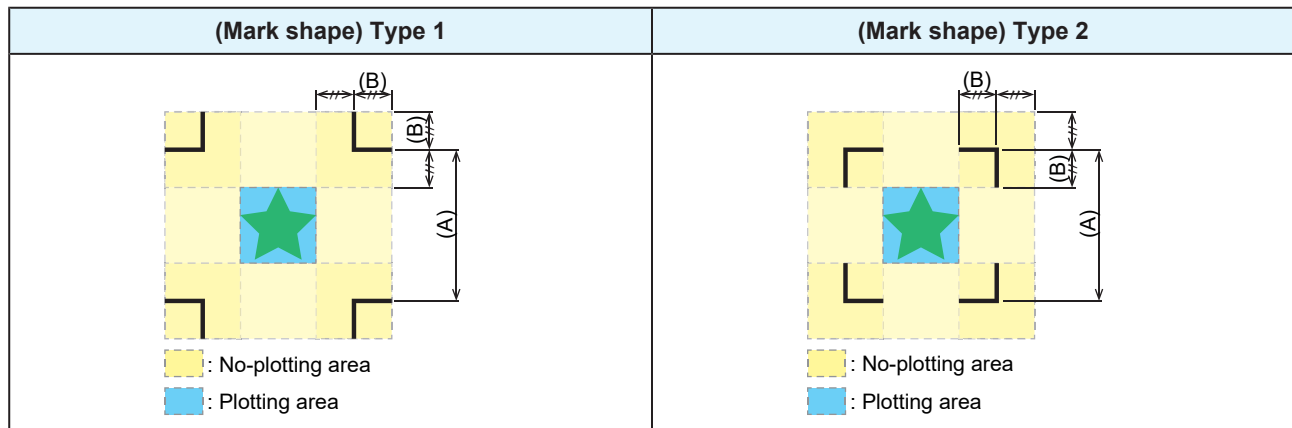

### ● Mark Origin Mis-detection Example

- If register marks are plotted in the no-plotting area as shown in the figure below, the line may be incorrectly identified as a register mark.

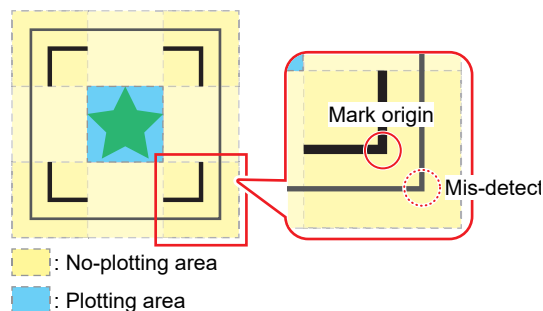

## Combined Operations of Printing and Cutting

When printing and cutting with MIMAKI RIP software (RasterLink, FineCut), please note the following:

- The mark size and mark shape settings configured in the machine will be disregarded. The software settings will be applied.
- We recommend printing and cutting using data with register marks. The volume of print data may affect cutting accuracy.
- Although it is possible to print and cut data without register marks using take-up units, doing so may reduce cutting accuracy.



## 4.3 Setting Mark Detection Conditions

Set the conditions of the printed register marks.

**1** On the LOCAL mode screen, select [MENU] > [Cutting], then press the [ENTER] key.

- The Cutting menu is displayed.

**2** Select [Mark Detect], then press the [ENTER] key.

- The Mark Detect menu is displayed.



- The Mark Detect menu can also be displayed as follows:

- (1) On the LOCAL mode screen, select [TEST CUT].
  - (2) Select [TP Detect Setup], then press the [ENTER] key.
- 

**3** Select and set the items.

-  ["Cutting Menu"\(P. 125\)](#)

## 4.4 Detecting the Position of the Register Mark Origin

- 1 On the LOCAL mode screen, select [TEST CUT].

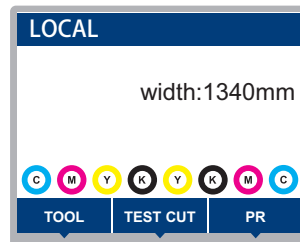

- 2 Select [Mark Detection], then press the [ENTER] key.

- The machine switches to MARK DETECT mode.
- The cutting unit moves over the platen.



- If the machine does not switch to MARK DETECT mode, set the [TEST CUT] > [TP Detect Setup] > [Mark Detect] setting to "ON".

- 3 Press to move the LED pointer to the center of the register mark.

(Mark shape) Type 1	(Mark shape) Type 2

- 4 Press the [ENTER] key.

- Register mark detection starts.

## 4.5 ID Cut Process

### 1. Create data with ID Cut.



- For more information, refer to the ID Cut Guide. <https://mimaki.com/download/software.html>

### 2. Print printing data with ID Cut.

"Print Process"(P. 50)

### 3. Prepare for cutting.

"Cutting Process"(P. 82) (Steps 4 to 8)

### 4. Register the information for the printed register marks.

"Setting Mark Detection Conditions"(P. 105)

### 5. Detect the register mark origin.

"Detecting the Position of the Register Mark Origin"(P. 106)

### 6. Cut the data.

"Cutting the Cutting Data"(P. 94)

### 7. Cutting the media

"Cutting the media"(P. 79)



# Chapter 5 Settings



## **This chapter**

This chapter describes the methods for replacing maintenance parts.

Setup menu .....	110	Machine setup menu .....	118
Temporary Use .....	112	Event Email Function Settings .....	120
Changing the name of a setting type .....	113	Nozzle check menu .....	123
LT mode .....	113	Information menu .....	124
Maintenance Menu .....	115	Cutting Menu .....	125
Registering Nozzle Recovery .....	116	Copying the Last Data .....	128
		Preventing Uncut Media .....	128

# 5.1 Setup menu

Print conditions (settings 1 to 4, Temporary) can be saved in advance for specific media. To set print conditions for a single use, select "Temporary". The conditions set in "Temporary" will not be saved.

## ● Menu List

The user can select to prioritize the settings on the machine or the settings on the PC. Setting individual menus to "Host" prioritizes PC settings. To prioritize settings for this machine, select a setting other than "Host".

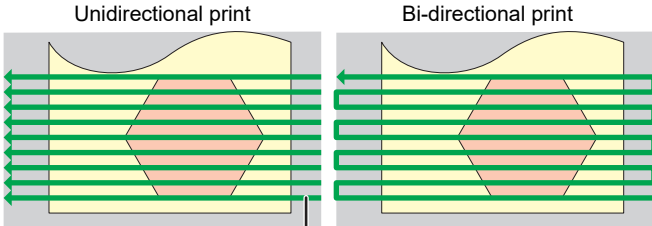
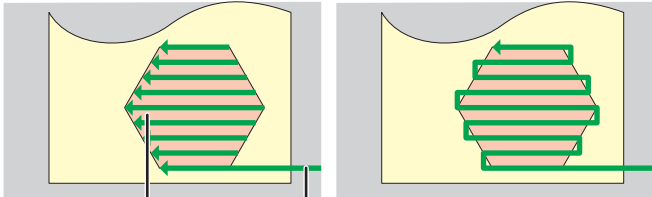

- For more information on how to specify RIP software, refer to the RIP software operating manual.

Item	Setting		Details
	*1	*2	
Feed Comp.	-9999 to <u>0</u> to 9999	-	Corrects the media feed amount. <ul style="list-style-type: none"> <li>• Print a pattern and enter the correction amount.</li> </ul>
Drop.PosCorrect	-40.0 to <u>0</u> to 40.0	-	Corrects the drop position for bi-directional printing. <ul style="list-style-type: none"> <li>• Print a pattern and enter the correction amount.</li> </ul>
Logical Seek	<u>Host</u> /ON/OFF/ Media Width	OFF	<p>Sets the range of carriage movement.</p> <ul style="list-style-type: none"> <li>• OFF: Machine size area</li> </ul>  <p>Carriage movement</p> <li>• ON: Print data area</li>  <p>Print data Carriage movement</p> <li>• Media width: Media size area (This is supported in firmware version 2.8 and later)</li>  <p>Media Carriage movement</p>
OVER PRINT	<u>HOST</u> /1 to 9 times	1	Sets the number of overprinting.

Item	Setting		Details
	*1	*2	
DRYING TIME	-	-	Sets the time for ink to dry.
Scan	<u>Host</u> /0.0 to 9.9 sec	0	Sets the stop time of the carriage after each scan. <ul style="list-style-type: none"> <li>The MIMAKI RIP software (RasterLink) indicates this as "Pause Time per Scan".</li> </ul>
Print End	<u>Host</u> /0 to 120 min	0	Sets the stop time after printing. The next data is printed once the set time has elapsed. <ul style="list-style-type: none"> <li>The Mimaki RIP software (RasterLink) does not allow the user to specify Print End. If the machine is set to "HOST", the time will be "0".</li> </ul>
Margin/Left	<u>Host</u> /-10 to 85 mm	0 mm	Sets the offset value from the media left and right standard margins (15 mm). <ul style="list-style-type: none"> <li>The left and right margins should be set to at least -5 mm when using the media holder. This eliminates the risk of printing on top of the media holder.</li> <li>The Mimaki RIP software (RasterLink) does not allow the user to specify margins. If the machine is set to "Host", the offset value will be "0 mm" for the left and right margins.</li> </ul>
Margin/Right			
Vacuum	<u>Host</u> /Weak/Standard/Strong	Strong	Sets the force with which the medium is held down. <ul style="list-style-type: none"> <li>This can be used to prevent media jamming and print head damage caused by the media lifting up.</li> </ul>
Feed Speed	<u>Host</u> /10 to 100 to 200 %	100	Sets the media feed speed. <ul style="list-style-type: none"> <li>Depending on print conditions, the speed may not vary for certain settings.</li> <li>Setting to 100 % or more reduces the time required to complete printing but may affect print quality due to insufficient drying time.</li> </ul>
Auto Cleaning	-	-	Sets the conditions to start head cleaning automatically. <ul style="list-style-type: none"> <li>Use this setting if you observe any ejection failures (e.g., nozzle clogging, nozzle deflection).</li> </ul>
Setup	File/Length/Time/OFF	-	Starts head cleaning after printing ends once the preset conditions are exceeded.
Interval	-	-	-
(File)	1 to 1,000	-	Sets the interval at which the number of files is selected.
(Length)	0.1 to 100.0 m	-	Sets the interval at which the print length is selected.
(Time)	10 to 120 min	-	Sets the interval at which the print time is selected.
Type	Normal/Soft/Hard	-	Sets the head cleaning type.
Cleaning Check	ON/OFF	-	Sets whether nozzle checking is performed after head cleaning is completed.
Interval Wiping	3 to 255 min/OFF	-	Sets the time to automatically start print head wiping. The print head is wiped once the printing time exceeds the preset value, even if printing is in progress. <ul style="list-style-type: none"> <li>Use this setting if you observe any problems such as ink droplets dripping.</li> </ul>
UV mode	<u>ON</u> /OFF/NoPrint	ON	Sets whether to turn on the UV-LED lamp. <ul style="list-style-type: none"> <li>ON: Turns on the UV-LED lamp.</li> <li>OFF: Does not turn on the UV-LED lamp.</li> </ul>

Item	Setting		Details	
	*1	*2		
			<ul style="list-style-type: none"> <li>NoPrint: Turns on the UV-LED lamp without printing. (Not used under ordinary conditions)</li> </ul>	
UV AdjVal	-50 to <u>0</u> to 50 %	-	<p>You can change the preset UV lamp brightness. (This is supported in firmware version 2.8 and later.)</p> <ul style="list-style-type: none"> <li>Minus direction: Reduces hardness.</li> <li>Plus direction: Increases hardness.</li> </ul> <p>* Check the print results for stickiness and odor.</p>	
MAPS4	-	-	<p>MAPS: Mimaki Advanced Pass System</p> <ul style="list-style-type: none"> <li>This function disperses the boundaries between passes to make feed streaks between passes less visible.</li> <li>Altering MAPS may alter the color. This function may be less effective with certain types of images.</li> </ul>	
MAPS4	<u>AUTO/</u> <u>MANUAL</u>	-	This should normally be set to "AUTO". When set to "MANUAL", the following items are displayed:	
	Smoothing Level	0 to 100 %	-	Increasing smoothing makes streaks less visible.
	Speed	50 to 100 %	-	Reducing speed will make streaks less visible. However, printing will be slower.
	Expansion	ON/OFF	-	Selecting "ON" will make streaks less visible. However, it may increase visible grain.
Ionizer	ON/OFF	-	<p>Sets the ionizer (optional). For more information, refer to the operating manual for the ionizer.</p> <ul style="list-style-type: none"> <li>Displayed when an option is connected.</li> </ul>	
LT mode	ON/OFF	OFF	<p>Set if the machine needs more ink flexibility. This should be used under certain conditions.  "LT mode"(P. 113)</p> <p>* Check the print results for stickiness and odor.</p>	
Setup Reset	-	-	Initializes the details set.	

\*1. The default settings are shown underlined.

\*2. Settings applied if no settings can be made in the RIP software (host) or if this machine is prioritized.

## Temporary Use

"Temporary" is used to set print conditions for a single use. This is also useful if you only want to use some of the settings 1 to 4. The "Temporary" printing conditions can be saved to Settings 1 to 4.



- The conditions set in "Temporary" are cleared and "Setting 1" is active when the machine is restarted.

### ● To copy Settings 1 to 4 to "Temporary"

You can edit Settings 1 to 4 to set print conditions for single use.

#### 1 On the LOCAL mode screen, select [MENU] > [Setting], then press the [ENTER] key.

- The setting types are displayed.

#### 2 Select [Temporary].

- The Setup menu is displayed.  "Setup menu"(P. 110)



- 3** Select [Setup Reset] and press the [ENTER] key.
  - 4** Select [Copy], then press the [ENTER] key.
    - The copy source selection screen is displayed.
  - 5** Select the copy source (Settings 1 to 4). Press the [ENTER] key.
    - The copy confirmation screen is displayed.
  - 6** Press the [ENTER] key.
    - The settings are copied from the copy source to "Temporary".
- **To copy "Temporary" settings to Settings 1 to 4**
    - 1** On the LOCAL mode screen, select [MENU] > [Setting], then press the [ENTER] key.
      - The setting types are displayed.
    - 2** Select [Temporary].
      - The Setup menu is displayed.  "Setup menu"(P. 110)
    - 3** Select [Save], then press the [ENTER] key.
      - The Select Save Location screen is displayed.
    - 4** Select a save location (Settings 1 to 4). Press the [ENTER] key.
      - The save confirmation screen is displayed.
    - 5** Press the [ENTER] key.
      - The settings are copied from "Temporary" to the save location.

## Changing the name of a setting type

You can change the name of a setting type. The name can include alphanumeric characters or symbols.

- 1** On the LOCAL mode screen, select [MENU] > [Setting], then press the [ENTER] key.
  - The setting types are displayed.
- 2** Select Settings 1 to 4 and press the [FUNC2] key.
  - The rename screen appears.
- 3** Enter the desired name, then press the [ENTER] key.
  - The setting type is renamed.

## LT mode

LT mode is enabled under the following conditions:













Ink Type	Ink set	Resolution	Number of passes	Media
LUS170	4-color	300 × 900	6 passes	PVC
				Tarpaulin



Ink Type	Ink set	Resolution	Number of passes	Media
		600 × 600	8 passes	PVC
				Tarpaulin
	6-color	300 × 900	12 passes	PVC
				Tarpaulin
		600 × 600	16 passes	PVC
				Tarpaulin

## 5.2 Maintenance Menu

This menu is used for maintenance actions. It also lets the user perform nozzle recovery if nozzle clogging persists even after cleaning and nozzle washing.

### ● Menu List

Item	Setting <sup>*1</sup>	Details
Station Maint.	-	This moves the carriage to allow station and print head maintenance.
Carriage Out	-	
Station Maint.	-	Cleans around the station, including the cap, wiper, and NCU.  <a href="#">"Wiper Cleaning"(P. 134)</a>  <a href="#">"Cap Rubber Cleaning"(P. 136)</a>  <a href="#">"NCU Cleaning"(P. 137)</a>
Head Maintenance	-	Cleans around the print head.  <a href="#">"Carriage Underside Cleaning"(P. 138)</a>  <a href="#">"Media Sensor Cleaning"(P. 141)</a>  <a href="#">"Cleaning the Mist Filter"(P. 139)</a>  <a href="#">"Mist Filter Replacement"(P. 149)</a>
Nozzle Wash	-	Washes the print head nozzle surface with maintenance liquid to resolve print defects (e.g., nozzle clogging, deflection).  <a href="#">"Print Head Nozzle Washing"(P. 163)</a>
Pump tube cleaning	-	Washes the suction pump tube (below the cap).  <a href="#">"Ink Discharge Channel Cleaning"(P. 140)</a>
Custody Wash	-	Perform this step if the machine will not be used for extended periods. The function washes nozzles and drainage channels to maintain the machine in optimal condition.  <a href="#">"When this printer is left unused for a long time"(P. 144)</a>
Replace Wiper	-	Use this function when replacing the wiper. Replacing the wiper resets the wiper usage counter.  <a href="#">"Wiper Replacement"(P. 147)</a>
Nozzle Recovery	-	Allows other nozzles to be used for printing if maintenance actions like nozzle washing fail to resolve print defects (e.g., nozzle clogging, deflection).
Print	-	Prints a pattern to check nozzle condition and register the nozzle.  <a href="#">"Registering Nozzle Recovery"(P. 116)</a>
Entry	-	Registers the nozzle without printing a pattern.
Reset	-	Initializes the details set.
Test printing	ON/OFF	Sets whether to perform nozzle recovery before test printing. (This is supported in firmware version 2.5 and later.)
Auto Maint.	-	Sets various maintenance actions to be performed automatically. Set the interval between individual maintenance actions. <ul style="list-style-type: none"> <li>If the warning message "Replace Wasteinktank" appears, the automatic maintenance function is disabled.  <a href="#">"Waste Ink Tank Replacement"(P. 156)</a></li> <li>Beside the automatic maintenance function, the function for reapplying the negative pressure during sleep is executed in sleep mode. This maintains negative pressure inside the head during sleep by regularly applying negative pressure. This is</li> </ul>

Item	Setting <sup>*1</sup>	Details
		executed every 15 minutes in the first one hour, and then at intervals of 30 minutes. (This is supported in firmware version 2.8 and later.)
Refresh	0.5 to <u>4.0</u> h	Sets the refresh interval. <ul style="list-style-type: none"> <li>Ejects a small amount of ink from the print head nozzles. This will help prevent nozzle clogging.</li> </ul>
Cleaning Interval	1 to <u>12</u> h	Sets head cleaning intervals. <ul style="list-style-type: none"> <li>Cleans the print head. This will help prevent nozzle clogging.</li> </ul>
Type	Normal/ <u>Soft</u> /Hard	Sets the cleaning type for head cleaning.
Fill Up Ink	-	Fills the ink to resolve printing defects (e.g., nozzle clogging, deflection).
Replace Wasteinktank	-	Resets or corrects the waste ink tank usage count.  <a href="#">"Waste Ink Tank Replacement"(P. 156)</a>
Overflow	-	Performed when the "ink overflow" error is displayed. <ul style="list-style-type: none"> <li>Drains excess ink from the sub tank to resolve ink overflows.</li> <li>If the error is not cleared, execute this operation repeatedly. If it persists even after three attempts, contact your local dealer or our service office.</li> </ul>
Air PG	-	Use this if ink colors are mixed or if the mixed air causes nozzle clogging. Purge ink and air inside the print head from the port in front of the carriage.  <a href="#">"Ink colors are mixed."(P. 165)</a>

\*1. The default settings are shown underlined.

## Registering Nozzle Recovery

Allows other nozzles to be used for printing if maintenance actions like nozzle washing fail to resolve print defects (e.g., nozzle clogging, deflection).



- Nozzle recovery can be specified for up to ten nozzles per row. The time taken for printing remains unchanged even when nozzle recovery is set.



- Load media at least 500 mm wide. You cannot print the entire pattern if media less than 500 mm wide is used.

- 1 Position the media.**
- 2 On the LOCAL mode screen, select [MENU] > [Maintenance], then press the [ENTER] key.**
  - The Maintenance menu is displayed.

### 3 Select [Nozzle Recovery] > [Print], then press the [ENTER] key.

- Print a nozzle recovery pattern.
- The Select Entry Nozzle screen appears once printing is complete.

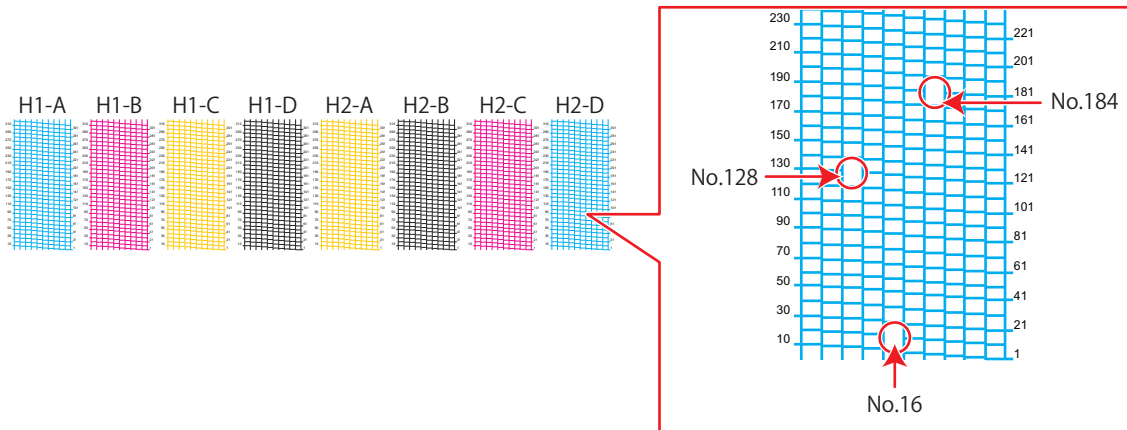

- For 6-color ink sets, "H1-B" and "H1-D" are not printed.

### 4 Select the "head number and nozzle row" for nozzle recovery, then press the [ENTER] key.

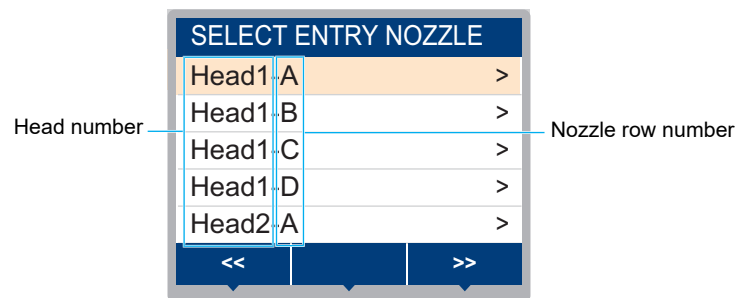

### 5 Enter the "nozzle number" for nozzle recovery, then press the [ENTER] key.

- Select the entry number before entering the nozzle number.
- Nozzle recovery is set.

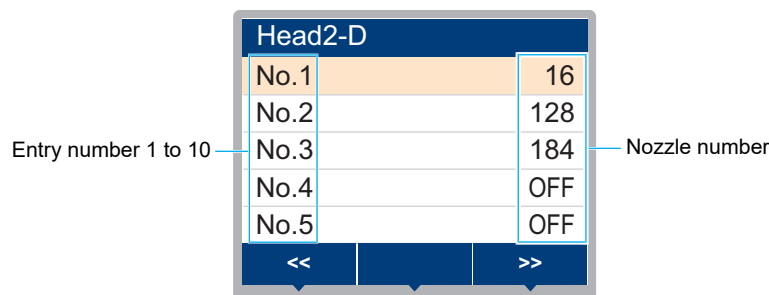

### 6 Press the [ENTER] key once entry is complete.



- Select [Maintenance] > [Nozzle Recovery] > [Test Print], then select "ON" to perform nozzle recovery and test printing. (This is supported in firmware version 2.5 and later.) 
- "Test Printing"(P. 69)

## 5.3 Machine setup menu

This is used to set various operations to ensure optimal machine performance.

### ● Menu List

Item	Setting <sup>*1</sup>	Details
Auto Power-off	None/10 to <u>30</u> to 600min	Sets the time until the power is automatically turned off.
Take-up Unit	-	Sets the take-up unit operation.
Take-up Unit	<u>ON/OFF</u>	Set to "OFF" if the take-up unit is not used.
Take-up SW	<u>Continuous/</u> <u>Temporary</u>	Sets the function performed by the ON/OFF button on the take-up unit in LOCAL mode. <ul style="list-style-type: none"> <li>• Continuous: Press the button to start/stop the take-up unit.</li> <li>• Temporary: The take-up unit operates only while the button is pressed. The unit stops when the button is released.</li> </ul>
Media Remain	<u>ON/OFF</u>	The remaining roll media amount can be displayed and printed out in REMOTE mode. The print length will be displayed when leaf media is in use. <ul style="list-style-type: none"> <li>• ON: An input screen appears once the media width is detected. <ul style="list-style-type: none"> <li>▲ Press ▼ to set the media length.</li> </ul> Press the [FUNC3] key on the "Origin Setup" screen to print the date and remaining media amount.</li> <li>• OFF: The remaining media amount is not displayed.</li> </ul>
Media Detect	-	Sets the media width detection method.
Detection Type	<u>AUTO/</u> <u>MANUAL</u>	<ul style="list-style-type: none"> <li>• AUTO: The media width is automatically detected with the sensor.</li> <li>• MANUAL: ▲ Press ▼ to set the media width manually. <ul style="list-style-type: none"> <li>– When using a media that cannot be detected by the sensor, such as black cutting sheets, set to "MANUAL".</li> </ul> </li> </ul>
Use PR Number Query	<u>ON/OFF</u>	Sets whether to display the screen for entering the number of pinch rollers to be used after media width detection. <ul style="list-style-type: none"> <li>• ON: Displays the input screen.</li> <li>• OFF: The "host" takes priority. Set this to "OFF" when configuring pinch roller pressure settings on this machine. <ul style="list-style-type: none"> <li>☞ <a href="#">"Setting the Pressure and Number of Pinch Rollers to Use"(P. 68)</a></li> </ul> </li> </ul>
LANGUAGE	<u>English/日本</u> <u>語/中文/</u> <u>Turkce</u>	Sets the display language.
Time Set	-20h to <u>0</u> to +4h	Sets the current time and date. (With respect to JST) <ul style="list-style-type: none"> <li>• This can be set within the range of -20 to +4 hours.</li> </ul>
UNIT / TEMP	<u>°C/°F</u>	Sets the display unit for temperature (Celsius/Fahrenheit).
UNIT / LENGTH	<u>mm/inch</u>	Sets the display units for length and area. <ul style="list-style-type: none"> <li>• Some items are displayed in "mm" even if "inch" is selected.</li> </ul>
Key Buzzer	<u>ON/OFF</u>	Sets an audible tone when keys are pressed. <ul style="list-style-type: none"> <li>• Audible signals indicating errors, warnings, and operation end cannot be muted, even if "OFF" is selected for this setting.</li> </ul>
View Feed	<u>ON/OFF</u>	Sets whether or not to feed the media forward to view the print results—for example, during test printing.

Item	Setting <sup>*1</sup>	Details
Space Feed Mode	<u>Intermittent/</u> <u>Continuous</u>	Alters the feed method for blank space included in the image data. <ul style="list-style-type: none"> <li>• Intermittent: Uses intermittent feeding based on the timing of a fraction of the pass.</li> <li>• Continuous: Feeds forward by skipping blank parts.</li> </ul>
Network	-	Sets the network address. The machine must be restarted to enable this setting.
Check IP Address	-	Displays the machine's current IP address. <ul style="list-style-type: none"> <li>• It may take some time to determine the IP address. If the IP address cannot be determined, the display will indicate "0.0.0.0".</li> </ul>
Check MAC Address	-	Displays the machine's current MAC address.
DHCP	<u>ON/OFF</u>	Select "ON" to use the IP address assigned by the DHCP server.
AutoIP	<u>ON/OFF</u>	Select "ON" to use the IP address set by the AutoIP protocol. Note that DHCP takes priority if DHCP is set to "ON".
Ip Address	-	Sets the IP address used by the machine. <ul style="list-style-type: none"> <li>• This can be set when both [DHCP] and [AutoIP] are disabled.</li> </ul>
Default Gateway	-	Sets the default gateway used by the machine. <ul style="list-style-type: none"> <li>• This can be set when both [DHCP] and [AutoIP] are disabled.</li> </ul>
DNS Address	-	Sets the DNS server address used by the machine. <ul style="list-style-type: none"> <li>• This can be set when both [DHCP] and [AutoIP] are disabled.</li> </ul>
Sub Net Mask	-	Sets the subnet mask used by the machine. <ul style="list-style-type: none"> <li>• This can be set when both [DHCP] and [AutoIP] are disabled.</li> </ul>
Event Mail	-	An email can be sent to a specified email address when an event (e.g., print start, print end, and abort) occurs. The machine must be restarted to enable this setting.  <a href="#">"Event Email Function Settings"(P. 120)</a>
Mail Delivery	<u>ON/OFF</u>	Sets whether event emails are sent.
Select Event	-	
Print Start Event	<u>ON/OFF</u>	Sets whether an email is sent when printing starts.
Print End Event	<u>ON/OFF</u>	Sets whether an email is sent when printing ends.
Plot Start Event	<u>ON/OFF</u>	Sets whether an email is sent when cutting starts.
Plot End Event	<u>ON/OFF</u>	Sets whether an email is sent when cutting ends.
Error	<u>ON/OFF</u>	Sets whether an email is sent when an error occurs.
Warning	<u>ON/OFF</u>	Sets whether an email is sent when a warning occurs.
Other Event	<u>ON/OFF</u>	Set to send or not send an email when an event other than those listed above occurs.
Mail Address	-	Sets the email address to which emails will be sent (not to exceed 96 alphanumeric characters or symbols).
Message Subject	-	Sets the characters contained in a message subject (not to exceed 8 alphanumeric characters or symbols).
Server Setup	-	

Item	Setting <sup>*1</sup>	Details
SMTP Address	-	Sets the SMTP server.
SMTP Port No.	-	Sets the SMTP port number.
Sender Address	-	Sets the sender address (not to exceed 64 alphanumeric characters or symbols). <ul style="list-style-type: none"> <li>Setting an email address corresponding to the server account allows emails to be sent.</li> </ul>
Authentication Method	<u>OFF/POP before SMTP/SMTP authentication</u>	Sets the SMTP server authentication method.
User Name	-	Sets the user name used for authentication (not to exceed 30 alphanumeric characters or symbols). <ul style="list-style-type: none"> <li>This can be set when [Authentication] is not set to "OFF".</li> </ul>
Password	-	Sets the password used for authentication (not to exceed 15 alphanumeric characters or symbols). <ul style="list-style-type: none"> <li>This can be set when [Authentication] is not set to "OFF".</li> </ul>
POP3 Address	-	Sets the POP server. <ul style="list-style-type: none"> <li>This can be set when [Authentication] is set to "POP before SMTP".</li> </ul>
APOP	-	Sets the APOP on or off. <ul style="list-style-type: none"> <li>This can be set when [Authentication] is set to "POP before SMTP".</li> </ul>
Transmit Test	-	Sends a test email.  <a href="#">"Transmit Test"(P. 120)</a>
Reset	-	Initializes the details set.

\*1. The default settings are shown underlined.

## Event Email Function Settings

An email can be sent to a specified email address when an event (e.g., print start, print end, and abort) occurs.



- SSL (Secure Socket Layer) encoding is not supported.



- Connect the LAN cable to use the event mail function.  ["Using a LAN Cable"\(P. 35\)](#)

### Disclaimers

- Internet communication charges for email notifications, etc. are the responsibility of the customer.
- Event emails may not be delivered if problems arise with the Internet setup or equipment. Mimaki rejects all liability for damages resulting from delivery failure or delay.

## Transmit Test

**1** In LOCAL mode screen, select [MENU] > [Machine Setup], then press the [ENTER] key.

- The Machine Setup menu is displayed.



**2** Select [Event Mail] > [Transmit Test], then press the [ENTER] key.

**3** Press the [ENTER] key.

- The transmission results are displayed.
- An error code will be displayed if the test email transmission is unsuccessful. Refer to the error code list and take appropriate action.

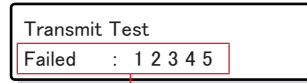

Error code



- Emails may not necessarily be delivered even if they have been sent. Check the terminal receiving the email for spam email filters.
- For more information on server settings or other topics, contact your network administrator or service provider.

**4** Press the [ENTER] key once the test is complete.

#### ● Error code list

Error code	Likely cause	Corrective action
10	Network connection error	<ul style="list-style-type: none"> <li>• Check to confirm that this machine is connected to a network.</li> <li>• Check the IP address for this machine.</li> <li>• Check if the network setup allows this machine to use DNS.</li> </ul>
20	No valid email address	<ul style="list-style-type: none"> <li>• Enter a valid email address.</li> </ul>
11003 11004	No POP server could be found. or the DNS server could not be accessed.	<ul style="list-style-type: none"> <li>• Check the POP server address.</li> <li>• Check if the network setup allows this machine to use DNS.</li> </ul>
11021	Unable to connect to POP server	<ul style="list-style-type: none"> <li>• Check the POP server settings.</li> <li>• Check the firewall settings.</li> </ul>
12010	An error was returned from the POP server.	<ul style="list-style-type: none"> <li>• Check the POP server settings.</li> </ul>
13000	POP authentication failed.	<ul style="list-style-type: none"> <li>• Check the user name and password.</li> <li>• Check the APOP settings.</li> <li>• Check the authentication method.</li> </ul>
10013 10014	No SMTP server could be found. or the DNS server could not be accessed.	<ul style="list-style-type: none"> <li>• Check the SMTP server address.</li> <li>• Check if the network setup allows this machine to use DNS.</li> </ul>
10021	Unable to connect to SMTP server	<ul style="list-style-type: none"> <li>• Check the SMTP server settings.</li> <li>• Check the SMTP port number.</li> <li>• Check the firewall settings.</li> </ul>
10*** 11*** 20*** 21***	An error was returned from the SMTP server. or there was no response.	<ul style="list-style-type: none"> <li>• Check the SMTP server settings.</li> <li>• Communication is not possible with a server that requires SSL communication.</li> <li>• Check the protocol filter settings.</li> </ul>
12***	The sender email address is invalid.	<ul style="list-style-type: none"> <li>• Set an email address corresponding to the server account.</li> </ul>

Error code	Likely cause	Corrective action
13***	The email recipient could be found or the email address is invalid.	<ul style="list-style-type: none"> <li>• Check the email address.</li> <li>• This error may not always be detected even if the email address is incorrect.</li> <li>• Set an email address corresponding to the server account.</li> </ul>
22000 22008	SMTP authentication error	<ul style="list-style-type: none"> <li>• Check the authentication method.</li> </ul>
23*** 24*** 25***	SMTP authentication failed.	<ul style="list-style-type: none"> <li>• Check the user name and password.</li> </ul>

1. \*\*\* is the error code received from the mail server



- If the error persists, wait a while before retrying.

## 5.4 Nozzle check menu

This is used to check if the nozzles are clogged before printing. Sets whether to perform maintenance functions automatically if nozzle clogging is detected.

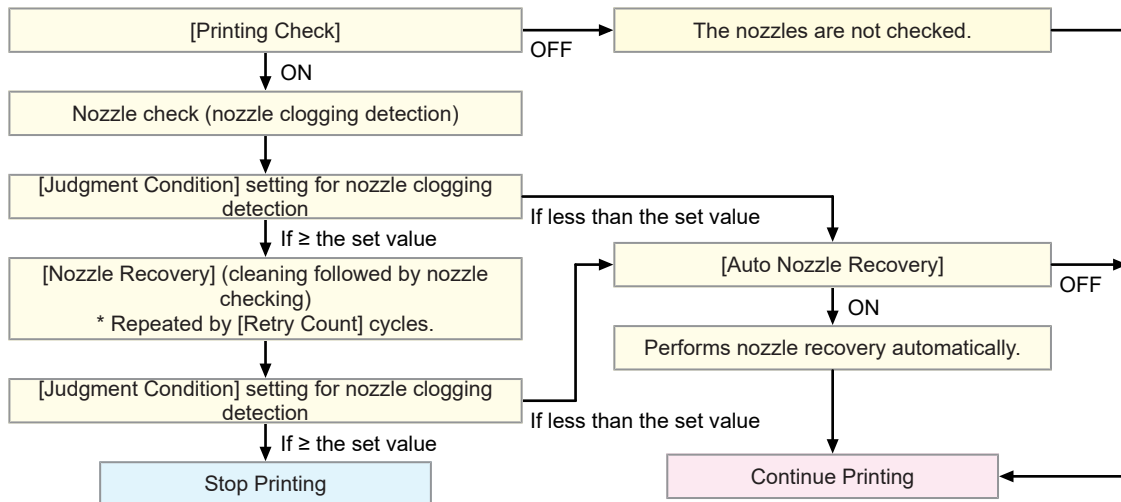

### ● Menu List

Item	Setting <sup>*1</sup>	Details	
Printing Check	ON/OFF	Performs nozzle clogging detection before printing starts.	
Check Interval	-	Sets the nozzle clogging detection timing.	
	Length	0.1 to <u>30.0</u> to 50.0m	Performs nozzle clogging detection after the length set is reached and before the next print starts.
	File	1 to <u>30</u> to 100 files	Performs nozzle clogging detection after the preset number of files has been printed and before the next print starts.
	Action	-	Performs nozzle recovery (cleaning followed by nozzle checking) if "nozzle clogging" is detected.
	Cleaning	<u>Soft</u> /Normal/ Hard	Sets the cleaning type.
Retry Count	<u>0</u> to 3 times	Performs nozzle recovery (cleaning followed by nozzle checking) for the specified number of times.	
Auto Nozzle Recovery	ON/OFF	Performs nozzle recovery automatically if "nozzle clogging" is detected. See below if you wish to perform nozzle recovery manually. <a href="#">"Registering Nozzle Recovery"(P. 116)</a>	
Judgment Condition <sup>*2</sup>	OFF/ <u>1</u> to 64 nozzles	Set the number of nozzles to be detected as clogged before "nozzle clogging" is detected. Up to 16 nozzles per row can be set. The next print will not start if "nozzle clogging" is detected during continuous printing.	

\*1. The default settings are shown underlined.

\*2. Nozzle recovery is not available for certain print conditions.



- If an error occurs during the nozzle check operation, the next print will be automatically stopped, and [Printing Check] will be set to "OFF". Clear the error, then set [Printing Check] to "ON" manually.

## 5.5 Information menu

This is used to check machine information.

### ● Menu List

Item		Details
Usage	Wiping	Displays the wiping count. <ul style="list-style-type: none"> <li>To reset this count, press the [FUNC2] key while the count is displayed.</li> </ul>
	Waste ink tank	Displays the approximate level of waste ink in the waste ink tank as a percentage. <ul style="list-style-type: none"> <li>To reset waste ink levels, press the [FUNC1] key while the level is displayed.</li> </ul>
	Print Length	Displays the total length printed.
	Print Area	Displays the total area printed.
	Use Time	Displays the total time the power has been turned on.
	UV Lamp	Displays the total time the UV lamp has been used.
Version		Displays the machine firmware and other versions.
Ink REPL.Report		Prints the ink history.
Error History		Displays the error and warning history. <ul style="list-style-type: none"> <li>These are listed in chronological order. Use the keys to cycle through occurrence time/date and error/warning information.</li> </ul>
List		This is used to print machine information.

## 5.6 Cutting Menu

You can set various settings related to cutting functions.

### ● Menu List

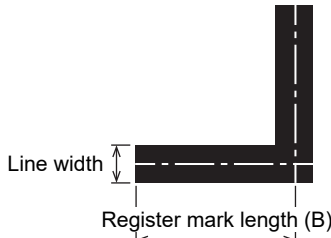
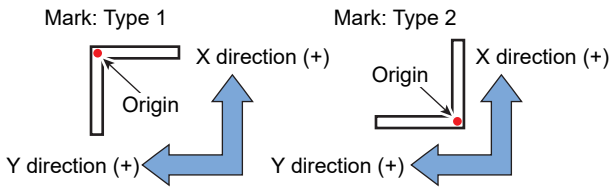
Item	Setting <sup>*1</sup>	Details
Mark Detect	-	Enter the conditions of the printed register marks.
Detect	ON/OFF	Set this to ON to cut cutting data with register marks.
Form	Type 1/Type 2/Zero Margin TP	Select three types of register mark shapes. ☞ <a href="#">"Register Marks"(P. 100)</a>
Size	5 to 40 mm	Set the register mark length (B).  ☞ <a href="#">"Standards for Register Mark Length and Line Width"(P. 101)</a>
Offset X	-5.00 to 5.00 mm	Change the position of the register mark origin. If the cut position shifts in the same direction, change the position of the origin.
Offset Y	-5.00 to 5.00 mm	 • If "ERROR C37 Mark Org" is displayed, change the layout by referring to the following. ☞ <a href="#">"Reading Range of Register Marks"(P. 103)</a>
Detect End Key Start	ON/OFF	If you press the [END] key on the LOCAL mode screen, the cutter unit moves over the platen so that register marks can be detected.
Sensor sensitivity	1 to 7	Check the sensitivity of the register mark sensor. Normally, set this to "4". • If it cannot detect the register marks: Increase sensitivity. • If it mis-detects the register marks: Decrease sensitivity.
Mark FillUp	ON/OFF	When the "Fill around the registration marks" function of the RIP software is enabled, set this to "ON".
Detect Area	-	Sets the automatic register mark detection area.

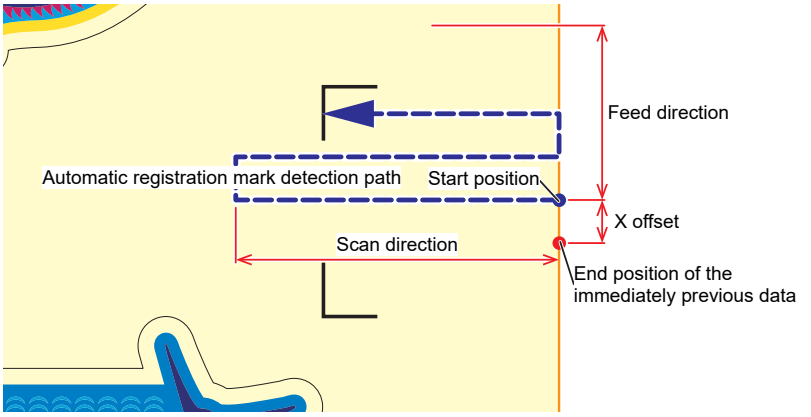
Item	Setting <sup>*1</sup>	Details	
			
	Scan Dir.	DEFAULT/0 cm to machine width	Sets the scan direction for automatic register mark detection. <ul style="list-style-type: none"> <li>When set to [DEFAULT], the detection operation is performed at half the media width.</li> </ul>
	Feed Dir.	10 to 50cm	Sets the media feed direction for automatic register mark detection.
	Offset X	0 to 100cm	Sets the automatic detection start position for the next register mark.
Cut Mode	<u>Normal/</u> HighSpd/ Quality	Sets the cutting quality. <ul style="list-style-type: none"> <li>Normal: Normally, use this setting.</li> <li>HighSpd: This cuts media in a short period of time. This is not suitable for use with heavy media.</li> <li>Quality: This puts priority on the cutting quality, and limits the cutting speed to 20 cm/s. Select "Quality" when cutting the following data. <ul style="list-style-type: none"> <li>Text not larger than 10 mm</li> <li>Data with many acute angles</li> <li>Intricate data (However, cut lines may be jagged depending on the data. If this occurs, change the setting to "HighSpd" to make cut lines smoother.)</li> </ul> </li> </ul>	
Copy	-	Cut the data stored in the receive buffer of the machine by the specified number. ☞ <a href="#">"Copying the Last Data"(P. 128)</a>	
	No. Copies	1 to 999	Enter the number of copies.
	Interval	0 to 30 mm	Select the cut data interval.
Tool Change	-	Select this when replacing tools. ☞ <a href="#">"Installing Cutting Tools"(P. 84)</a>	
Setup Sub Menu	-	Useful functions when cutting.	
	Up Speed	-	
	Up Speed X	<u>AUTO/5</u> to 30 cm/s	Set the movement speed of the media and carriage while the tool is up. Setting a slower speed can reduce media offsets in the feed direction.
	Up Speed Y	<u>AUTO/5</u> to 30	Set the movement speed of the media and carriage while the tool is up.
DUMMY CUT	<u>ON/OFF</u>	Cuts the media to make the cutting blade face a certain direction after media detection or tool changes. (Performs a dummy cut in front of the pinch rollers which are closest to both ends of the cutter unit.)	

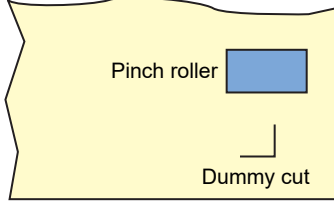
Item	Setting <sup>*1</sup>	Details
		 <p>If you wish to avoid damage to the media or cut cut-out characters, set this to OFF. Perform test cutting to adjust the direction of the cutting blade. ☞ "Test Cutting"(P. 93) If the tool condition is set to "PEN", dummy cutting is disabled.</p>
Sheet Type	<u>Standard/</u> Heavy	Set the weight of the set media.
Adj-prs Offset	-9 to <u>0</u> to 9	When cutting the corners, the pressure is automatically decreased (by about 5 g) to prevent the media from lifting up. As a result, the cutting blade might not rotate smoothly and may leave uncut parts. Adjust the pressure for cutting the corners if they are left uncut.
Vacuum Fan	<u>Weak/</u> Standard/ Strong/OFF	Sets the force with which the medium is held down during cutting. Ordinarily, use "Weak".
Over Cut	<u>OFF/0.1</u> to 1.0 mm	Overlaps the start and end points so that no part of the media is left uncut. ☞ "Preventing Uncut Media"(P. 128)
Corner Cut	ON/ <u>OFF</u>	Performs over cutting at corners other than the start and end point. ☞ "Preventing Uncut Media"(P. 128)
Curve Mode	<u>FAST/SLOW</u>	If the cut line gets twisted, set this to "SLOW". This can prevent twisting but decreases cutting speed.
Setup Reset	-	Initializes the details set.
Maintenance	-	
Marks Sensor	-	
Sensor Check	-	Check the responsiveness of the register mark sensor. ☞ "Adjusting the Position of the Register Mark Sensor"(P. 169)
Pointer Offset	-	Adjust the position of the light pointer when the positions of the register mark sensor and light pointer do not match. ☞ "Correcting the LED Pointer Position"(P. 170)
Sample Cut	-	The machine cuts a sample stored in the unit to troubleshoot problems when data cannot be cut properly. ☞ "Investigating the Cause of Cutting Failures"(P. 171)
Auto Media Cut	-	Cuts the media into several pieces of fixed length.
Cut Interval	10 to 10,000 mm	Sets the cut length.
Front Cut Off	0 to 500 mm	The front edge of the media can be cut off if cut diagonally. Sets the cut length.
Count	1 to 9,999 times	Sets the number of media pieces to be cut.
Scale Adjust	-	

Item		Setting <sup>*1</sup>	Details
	Y600 dpi	-	When printing and cutting without register marks, perform corrections when the media deviates to the left or right side of the scan direction.
	Y1200 dpi	-	

\*1. The default settings are shown underlined.

## Copying the Last Data

You can cut the data stored in the receive buffer of the machine by the specified number (up to 999 sheets).

- The last cutting data is stored in the receive buffer. When new data is received, the already saved data is overwritten.
- Reset the origin before executing the copy function. Failure to do so will result in overlap cutting.

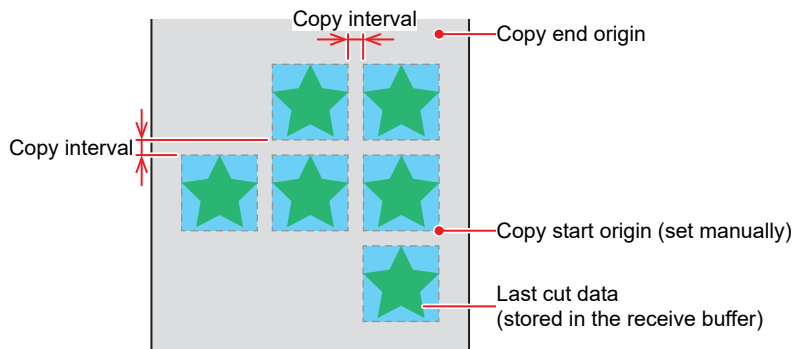

- The machine cuts the specified number of sheets of the divided cut data without separating the data.



- When using the MIMAKI cutting software "FineCut", deselect the "Sheet Feed Origin Renewal" checkbox. (This is unselected by default.) Selecting the checkbox results in overlap cutting.
- When sending the cut data from the PC, wait for at least 5 seconds before sending the next data. If the next data is sent within 5 seconds, both pieces of data may be copied.

## Preventing Uncut Media

Overlapping the start and end points can prevent the media from being left uncut. Configure this setting for very flexible media. Setting too large a value will result in cut prints. Perform test cutting and adjust accordingly.

### ● Over Cut

The machine cuts the media in front of the cutting start point by the set value. The media is overcut by the set value at the end point.

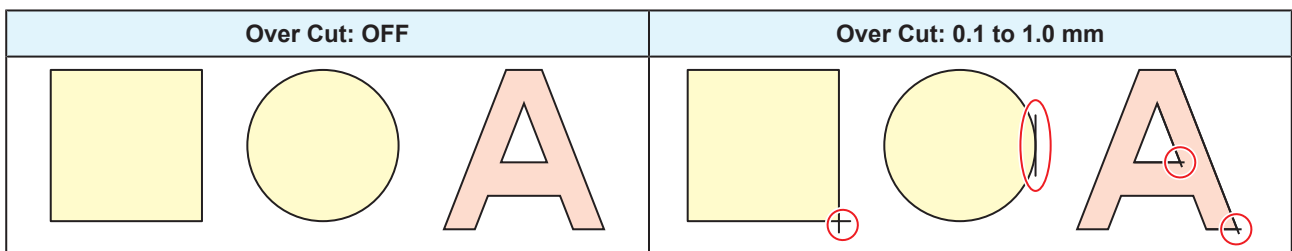

### ● Corner Cut

When the Over Cut setting value is entered, Corner Cut is displayed. The machine performs over cutting at corners other than the start and end point.

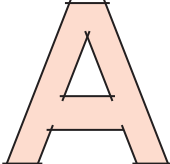

Corner Cut: OFF	Corner Cut: ON
	



# Chapter 6 Maintenance



## This chapter

To ensure years of precise performance, maintain the machine periodically based on frequency of use.

Read the maintenance precautions thoroughly before maintaining this product.

Maintenance Precautions .....	132	Consumable Item Replacement .....	147
Maintenance Methods .....	133	Wiper Replacement .....	147
Maintenance Items and Timing .....	133	Cap Absorber Replacement.....	148
Ink Maintenance.....	134	Mist Filter Replacement .....	149
Wiper Cleaning.....	134	LED Glass Replacement.....	150
Cap Rubber Cleaning.....	136	Exhaust Fan Filter Replacement.....	151
NCU Cleaning .....	137	Pinch Roller Replacement .....	152
Carriage Underside Cleaning.....	138	Media Holder Replacement .....	153
Cleaning the Mist Filter .....	139	Media Cutter Replacement .....	155
Ink Discharge Channel Cleaning.....	140	Waste Ink Tank Replacement.....	156
Media Sensor Cleaning.....	141	About the Media Cutter .....	159
Media Holder Cleaning.....	142	Pen Line Replacement.....	160
Jam Sensor Cleaning.....	142		
Platen Cleaning.....	143		
Cover (Exterior) Cleaning.....	144		
When this printer is left unused for a long time .....	144		

## 6.1 Maintenance Precautions



- This machine includes parts that must be replaced periodically. We therefore recommend taking out a maintenance contract. Carry out maintenance periodically and replace consumable items to prevent quality defects and accidents.

### ⚠ WARNING



- Clean periodically. Debris and dust will accumulate on electrical components when the machine is used for extended periods. There is a risk of failure, electric shock, or fire due to current leakage.
- Do not clean by blowing—e.g., avoid using air blowers. Doing so may lead to failure, electric shock, or fire involving the machine if airborne debris or dust gets inside electrical components. Wipe using a soft cloth soaked in diluted neutral detergent and thoroughly wrung out. A vacuum cleaner may also be used for cleaning.



- Do not allow liquids to get inside the machine. Otherwise there is a risk of failure, electric shock, or fire.

### ⚠ CAUTION



- The UV-LED unit becomes extremely hot. Be careful not to touch the LED after it has been turned off until it has sufficiently cooled.



- For heavy soiling, wipe using a soft cloth soaked in diluted neutral detergent and thoroughly wrung out.



- Pay close attention to ventilation and be sure to wear safety glasses, gloves, and a mask when handling ink, maintenance liquid, waste ink, or other solutions used with the machine. Leaking ink may adhere to the skin or get into the eyes or mouth.



### NOTICE



- Never touch the print head nozzle surface. Do not allow water or alcohol to come into contact with the print nozzle surface. This will increase the risk of machine failure or ejection failures (e.g., nozzle clogging or deflection).
- Do not use cotton swabs to clean around the head or carriage. Fibers from cotton swabs may adhere to the head nozzle surface and lead to ejection failures (e.g., nozzle clogging or deflection).
- Do not splash ink or maintenance liquid on the covers. Exposure to splashing ink or maintenance liquid may damage or deform the cover.
- Do not use benzine, thinner, or any chemical agent containing abrasives. Use of these chemicals may result in damage to or deformation of parts.
- Do not move the carriage by hand. To move the carriage, use the carriage out function on the menu.

## 6.2 Maintenance Methods

### Maintenance Items and Timing

UCJV300/150

Timing	Item
At the end of the work day	Clean the wiper and wiper bracket. <a href="#">"Wiper Cleaning"(P. 134)</a>
	Clean the wiper cleaner. <a href="#">"Wiper Cleaning"(P. 134)</a>
	Clean the cap rubber. <a href="#">"Cap Rubber Cleaning"(P. 136)</a>
	Clean the NCU. <a href="#">"NCU Cleaning"(P. 137)</a>
	Clean the underside of the UV- LED lamp. <a href="#">"Carriage Underside Cleaning"(P. 138)</a>
	Clean the underside of the carriage. <a href="#">"Carriage Underside Cleaning"(P. 138)</a>
	Mist filter 1 Soak up ink with a paper towel. <a href="#">"Cleaning the Mist Filter"(P. 139)</a>
	Clean the media sensor. <a href="#">"Media Sensor Cleaning"(P. 141)</a>
	Clean the media holder. <a href="#">"Media Holder Cleaning"(P. 142)</a>
	Clean the jam sensor. <a href="#">"Jam Sensor Cleaning"(P. 142)</a>
At the end of the week's work	Ink pad in the waste ink holder under the wiper Soak up ink with a paper towel. <a href="#">"Wiper Cleaning"(P. 134)</a>
	Mist filter 2 Soak up ink with a paper towel. <a href="#">"Cleaning the Mist Filter"(P. 139)</a>
	Clean the ink discharge channel. <a href="#">"Ink Discharge Channel Cleaning"(P. 140)</a>
	Clean the platen. <a href="#">"Platen Cleaning"(P. 143)</a>
	Clean the cover (exterior). <a href="#">"Cover (Exterior) Cleaning"(P. 144)</a>
	Check the waste ink levels in the waste ink tank.
When noticeably dirty	Replace with new exhaust fan filter. <a href="#">"Exhaust Fan Filter Replacement"(P. 151)</a>
	Replace the exhaust fan box.
When not used for more than a week	Clean the wiper and cap and wash the ink discharge channels. After cleaning, store without turning off the main power supply. <a href="#">"When this printer is left unused for a long time"(P. 144)</a>
Periodically	Shake the Ink bottle. <a href="#">"Ink Maintenance"(P. 134)</a>

### Items Required for Maintenance

To order replacement consumable items, contact your local dealer or our service office. For more information on consumable items, refer to our website (<https://mimaki.com/supply/inkjet.html>).



- Avoid storing this product in locations accessible to children.

## Ink Maintenance

If ink constituents are sedimented, the ink density may become uneven. We recommend shaking the Ink bottle periodically to keep printing consistent.

UV ink: once a month.

White ink: once a day.

### ● Shaking the Ink bottle

#### 1 Shake the Ink bottle to the left and right slowly at least 20 times.

- Tighten the ink bottle lid securely, then shake the bottle slowly from left to right to ensure that the ink moves inside, holding the ink bottle lid with a paper towel.

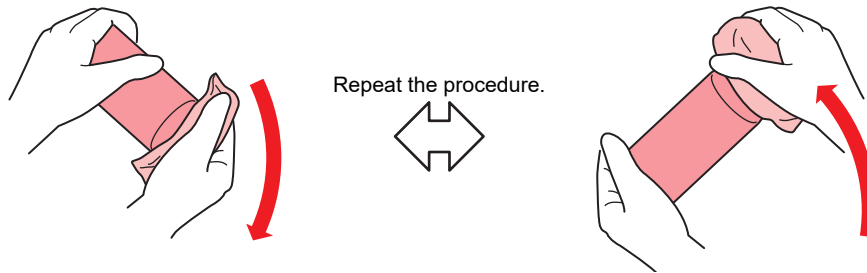

- Shake slowly. If the bottle is shaken too violently, ink may leak out or the air mixed in the ink may cause nozzle clogging.
- If the ink bottle is partially used, tilt it slowly until the ink bottle is upright.

## Wiper Cleaning

The wiper wipes off ink adhering to the print head nozzle surface. Continuing to use the dirty wiper may cause the wiper to which dried ink and dust are attached to rub against the nozzle surface, leading to printing defects (e.g., nozzle clogging or deflection).



- Be careful to avoid leaving fragments from the cleaning stick behind when cleaning. These fragments will increase the risk of ejection failures (e.g., nozzle clogging or deflection).

#### 1 On the LOCAL mode screen, select [MENU] > [Maintenance], then press the [ENTER] key.

- The Maintenance menu is displayed.

#### 2 Select [Station] > [Carriage Out] > [Station Maint.], then press the [ENTER] key.

- The carriage moves over the platen.

#### 3 Open the front cover.

#### 4 Detach the wiper.

- Pull out the wiper by holding the protrusions at both ends of the wiper bracket.

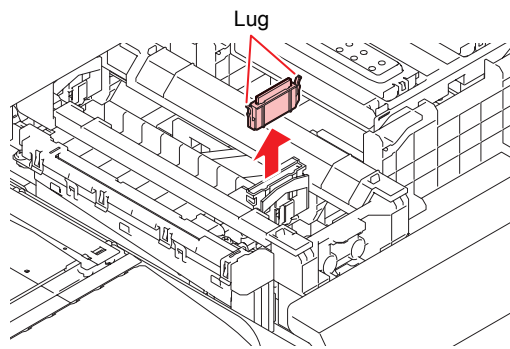

#### 5 Clean the wiper and bracket.

- Wipe off any ink and dust adhering using a cleaning stick moistened with maintenance liquid. Wipe off the maintenance liquid. Make sure none remains.

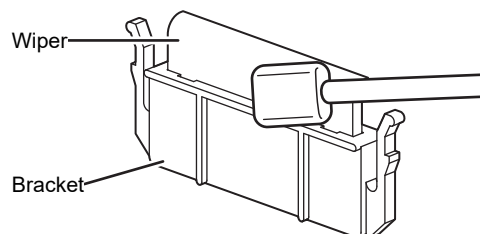

- Replace dirty or warped wipers with new ones. (👉 ["Wiper Replacement"\(P. 147\)](#))

#### 6 Clean the wiper slider.

- Wipe off any ink and dust adhering using a cleaning stick moistened with maintenance liquid. Wipe off the maintenance liquid. Make sure none remains.

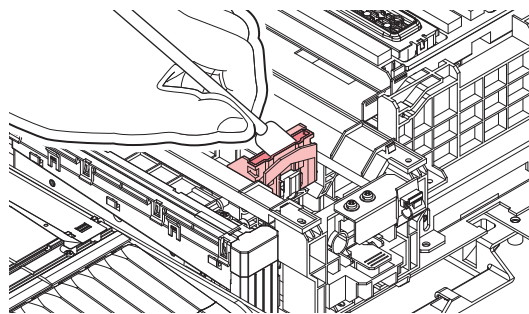

#### 7 Mount the wiper at the original position.

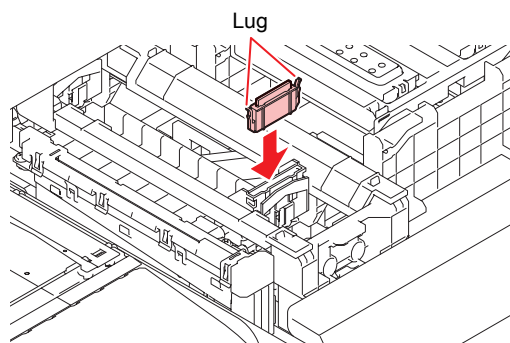

## 8 Clean the wiper cleaner.

- Wipe off any ink and dust adhering using a cleaning stick moistened with maintenance liquid. Wipe off the maintenance liquid. Make sure none remains.

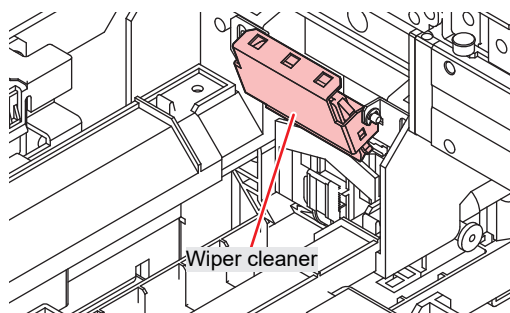

- Only clean the front side of the wiper cleaner. There is no need to clean the backside.



- Do not remove the wiper cleaner from the bracket.



- After cleaning is completed, check to confirm that the wiper cleaner is not facing up.

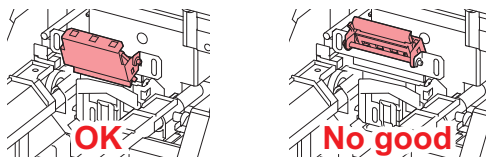

- Soak up ink in the waste ink holder with a paper towel once a week. Doing so may result in leaking ink.

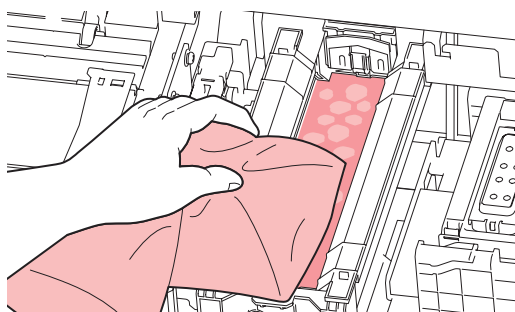

- Do not remove the absorbent material in the absorbent material case. Doing so may result in leaking ink.

## 9 Once cleaning is complete, close the cover, then press the [ENTER] key.

### Cap Rubber Cleaning

The cap prevents the print head nozzle surface from drying out. Continuing to use a dirty cap may affect ink take-up and lead to print defects (e.g., nozzle clogging, deflection).



- Be careful to avoid leaving fragments from the cleaning stick behind when cleaning. These fragments will increase the risk of ejection failures (e.g., nozzle clogging or deflection).

## 1 On the LOCAL mode screen, select [MENU] > [Maintenance], then press the [ENTER] key.

- The Maintenance menu is displayed.



**2** Select [Station] > [Carriage Out] > [Station Maint.], then press the [ENTER] key.

- The carriage moves over the platen.

**3** Open the front cover.**4** Clean the cap rubber.

- Wipe off any ink and dust adhering using a cleaning stick moistened with maintenance liquid. Wipe off the maintenance liquid. Make sure none remains.

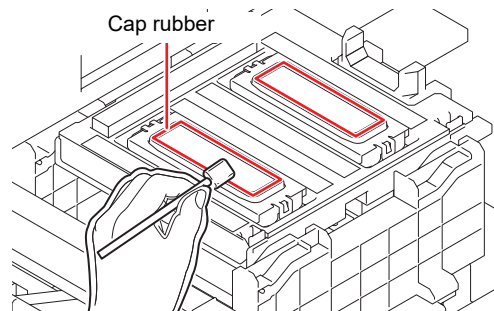
**5** Check to confirm that the cap slider is not tilted once cleaning is complete.

- If the cap slider is tilted, move the slider block to the left or right to correct the tilt.

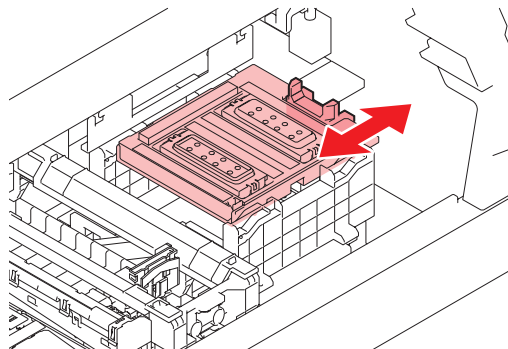
**6** Close the front cover, then press the [ENTER] key.**NCU Cleaning**

The NCU uses a sensor to monitor the ink droplets ejected from the print head nozzles. Continuing to use the dirty NCU may prevent the nozzle check function from operating correctly.



- Be careful to avoid leaving fragments from the cleaning stick behind when cleaning. These fragments will increase the risk of ejection failures (e.g., nozzle clogging or deflection).

**1** On the LOCAL mode screen, select [MENU] > [Maintenance], then press the [ENTER] key.

- The Maintenance menu is displayed.

**2** Select [Station] > [Carriage Out] > [Station Maint.], then press the [ENTER] key.

- The carriage moves over the platen.

**3** Open the front cover.

#### 4 Clean the NCU.

- Wipe off any ink and dust adhering using a cleaning stick moistened with maintenance liquid. Wipe off the maintenance liquid. Make sure none remains.

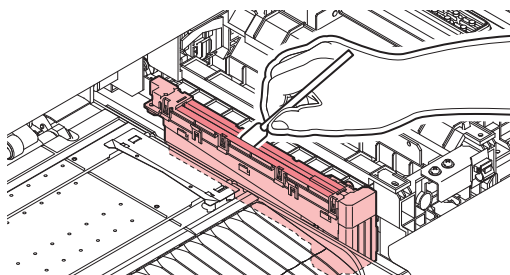

- Insert the cleaning stick as far as the line shown in the illustration.

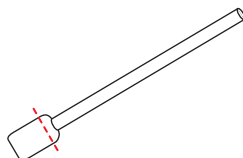

#### 5 Once cleaning is complete, close the cover, then press the [ENTER] key.

### Carriage Underside Cleaning

The underside of the carriage becomes coated with ink wiped off by the wiper. Continuing to use the dirty carriage underside will rub dried ink and attached dust on to the media, resulting in contaminated prints.

The print head uses an extremely delicate mechanism. Take great care when handling it.



- Be careful to avoid leaving fragments from the cleaning stick behind when cleaning. These fragments will increase the risk of ejection failures (e.g., nozzle clogging or deflection).

#### 1 On the LOCAL mode screen, select [MENU] > [Maintenance], then press the [ENTER] key.

- The Maintenance menu is displayed.

#### 2 Select [Station] > [Carriage Out] > [Head Maint.], then press the [ENTER] key.

- The carriage moves to the maintenance space.

#### 3 Open the maintenance covers.

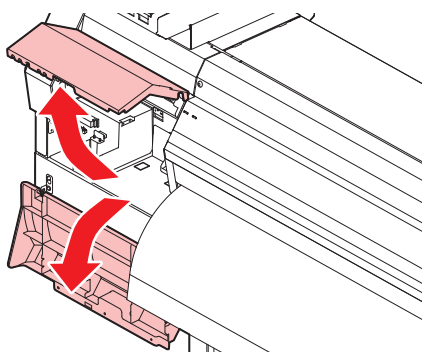

#### 4 Clean the UV-LED lamp.

- Wipe off any adhering ink using a cleaning stick moistened with maintenance liquid. Wipe off the maintenance liquid. Make sure none remains.

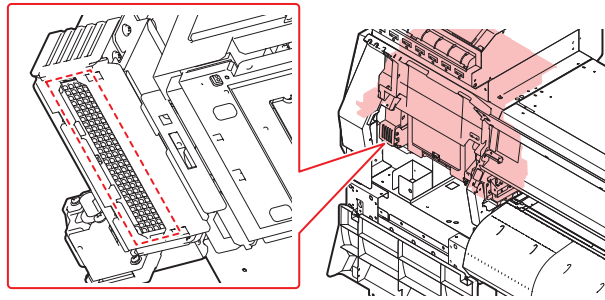

#### 5 Clean around the print head.

- Wipe off any ink and dust adhering using a cleaning stick moistened with maintenance liquid. Wipe off the maintenance liquid. Make sure none remains.

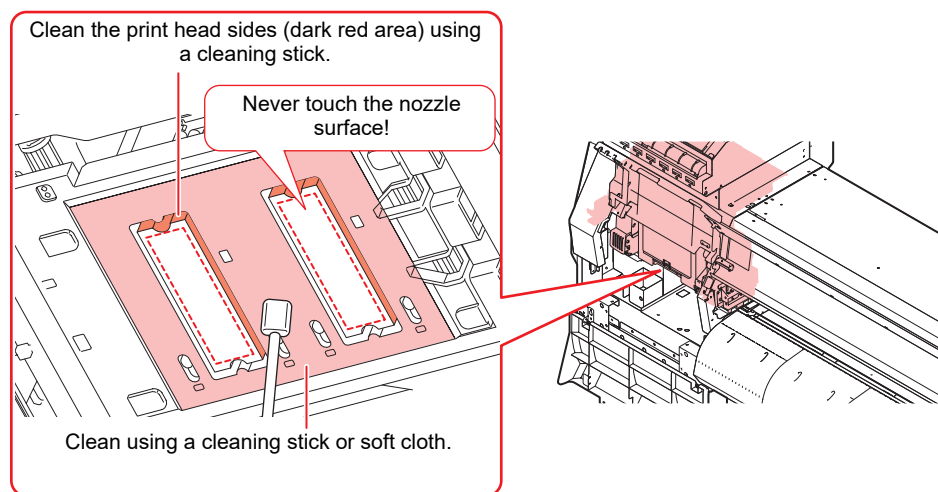

- Never touch the print head nozzle surface.

#### 6 Once cleaning is complete, close the cover, then press the [ENTER] key.

### Cleaning the Mist Filter

The mist filter absorbs the mist generated when ink droplets are discharged from the print head. Continuing to use it when it is dirty will result in contaminated prints.

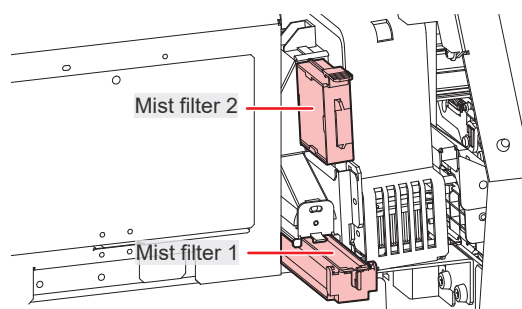

- On the LOCAL mode screen, select [MENU] > [Maintenance], then press the [ENTER] key.
  - The Maintenance menu is displayed.

## 2 Select [Station] > [Carriage Out] > [Head Maint.], then press the [ENTER] key.

- The carriage moves to the maintenance space.

## 3 Open the maintenance covers.

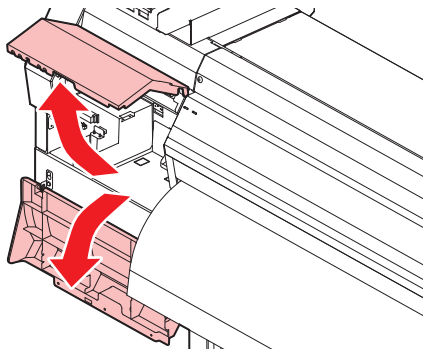

## 4 Remove the mist filter.

- To remove the mist filter, pull the knob to the front while pushing the tabs in the direction indicated by the arrows.

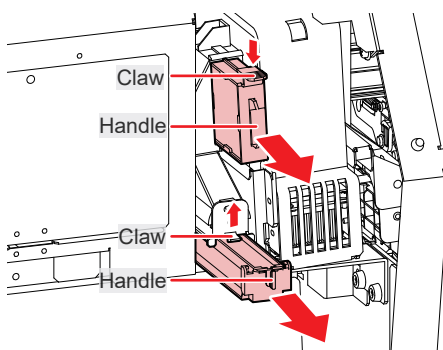

## 5 Clean the filter.

- Remove the filter and press down on it with a paper towel to remove the dirt.
- Wipe off the dirt adhering to the filter case.



- Replace the mist filter if it gets very dirty—for example, due to liquefaction of ink adhering to the filter.

 ["Mist Filter Replacement"\(P. 149\)](#)

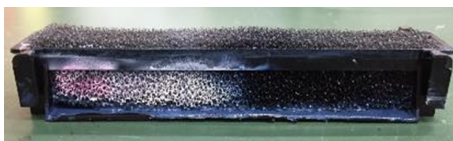

## 6 Mount the mist filter in its original position.

## 7 Once cleaning is complete, close the cover, then press the [ENTER] key.

## Ink Discharge Channel Cleaning

Clean the ink discharge channel regularly to prevent clogging of the ink discharge channel below the cap.

- 1** On the LOCAL mode screen, select [MENU] > [Maintenance], then press the [ENTER] key.
  - The Maintenance menu is displayed.
- 2** Select [Station Maint.] > [Pump tube cleaning], then press the [ENTER] key.
  - The carriage moves over the platen.
  - "Fill the Liquid. Exit Next [ENT]" appears on the display.
- 3** Open the front cover.
- 4** Fill the cap with maintenance liquid.
  - Use a syringe to draw up some maintenance liquid and fill until it almost overflows from the cap.

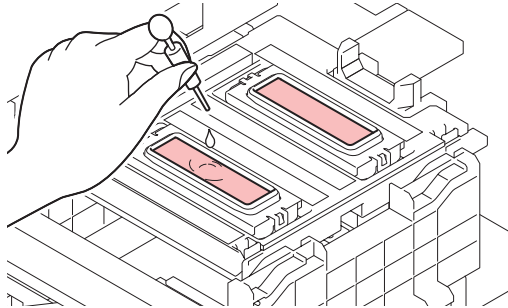

- 5** Close the front cover, then press the [ENTER] key.
  - Pump tube (ink discharge channel below the cap) washing starts.

## Media Sensor Cleaning

Media sensors are located on the rear cover and carriage underside. The media cannot be detected correctly if dust or debris accumulates on the sensors. Remove any debris using cotton swabs or a soft cloth.

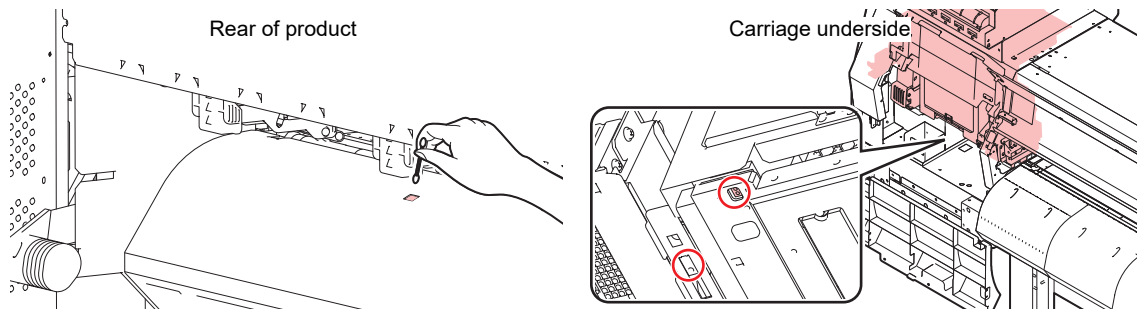

### ● Cleaning the carriage underside sensor

- 1** On the LOCAL mode screen, select [MENU] > [Maintenance], then press the [ENTER] key.
  - The Maintenance menu is displayed.
- 2** Select [Station] > [Carriage Out] > [Head Maint.], then press the [ENTER] key.
  - The carriage moves to the maintenance space.

### 3 Open the maintenance covers.

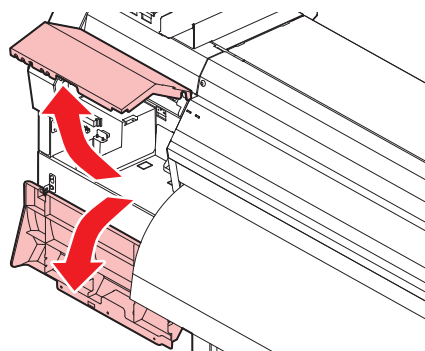

### 4 Clean the media sensor.

### 5 Once cleaning is complete, close the cover, then press the [ENTER] key.

## Media Holder Cleaning



- Turn off the main power supply and unplug the power cable before carrying out maintenance.



- Do not allow liquids to get inside the machine. Otherwise there is a risk of failure, electric shock, or fire.

Continuing to use the dirty platen will prevent proper feeding of the media. It will also cause dried ink and attached dust to rub against the head nozzle surface and lead to ejection failures (e.g., nozzle clogging or deflection).

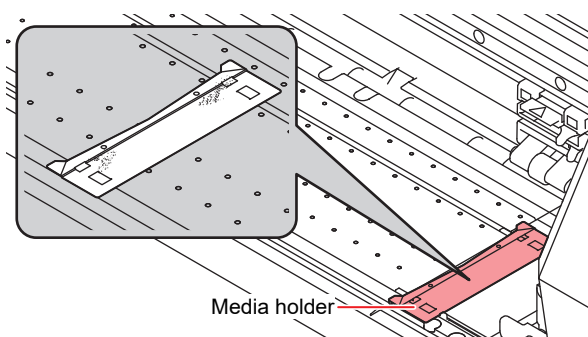

- For heavy soiling, wipe using a soft cloth soaked in diluted neutral detergent and thoroughly wrung out.

## Jam Sensor Cleaning

A jam sensor unit is located on the side of the UV-LED unit on the right of the carriage. Ink or dust buildup on the sensor unit may cause media jams. Clean using a paper towel.

### 1 On the LOCAL mode screen, select [MENU] > [Maintenance], then press the [ENTER] key.

- The Maintenance menu is displayed.

### 2 Select [Station] > [Carriage Out] > [Head Maint.], then press the [ENTER] key.

- The carriage moves to the maintenance space.

### 3 Open the front cover and maintenance covers.

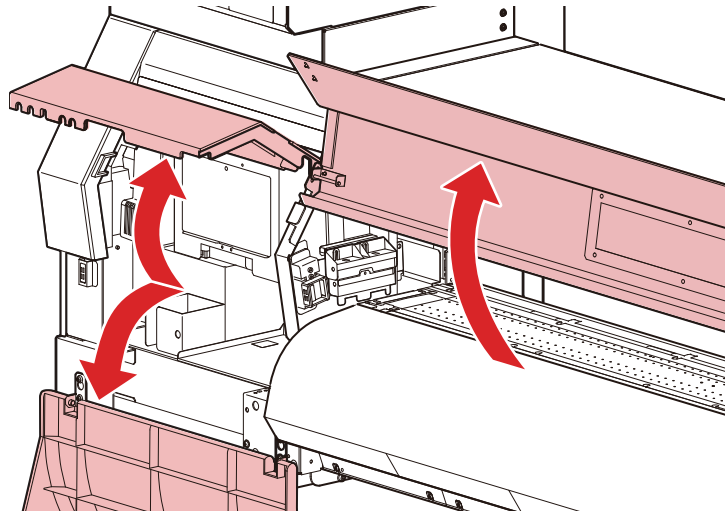

### 4 Clean the jam sensor unit.

- In particular, clean underneath the jam sensor, from both the front cover and maintenance cover sides.
- Wipe off any ink and dust adhering using a paper towel moistened with maintenance liquid. Wipe away any remaining maintenance liquid after cleaning.

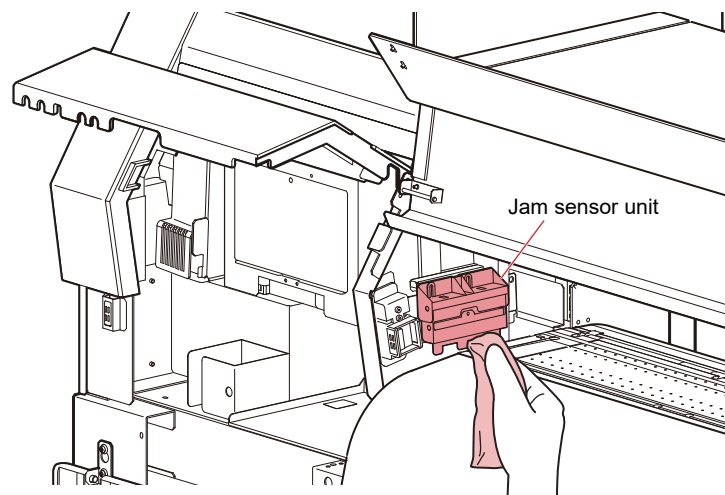

### 5 Once cleaning is complete, close the cover, then press the [ENTER] key.

## Platen Cleaning



- Turn off the main power supply and unplug the power cable before carrying out maintenance.



- Do not allow liquids to get inside the machine. Otherwise there is a risk of failure, electric shock, or fire.

Continuing to use the dirty platen will prevent proper feeding of the media. It will also cause dried ink and attached dust to rub against the head nozzle surface and lead to ejection failures (e.g., nozzle clogging or deflection).

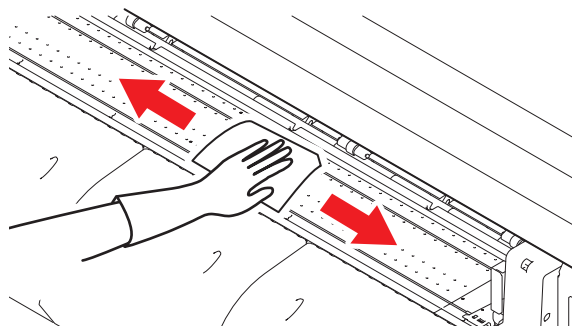

- The grooves in which the media holder slides and the media is cut are susceptible to dust accumulation. Remove any debris carefully.



- For heavy soiling, wipe using a soft cloth soaked in diluted neutral detergent and thoroughly wrung out.

## Cover (Exterior) Cleaning



- Do not allow liquids to get inside the machine. Otherwise there is a risk of failure, electric shock, or fire.

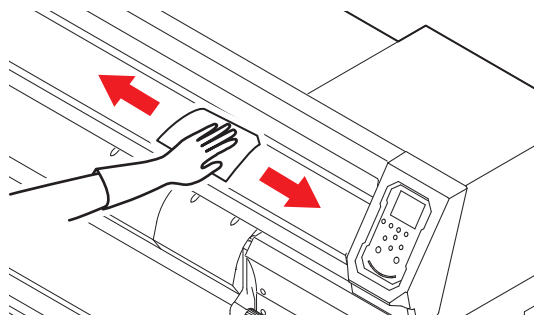

- For heavy soiling, wipe using a soft cloth soaked in diluted neutral detergent and thoroughly wrung out.

## When this printer is left unused for a long time

Clean as follows if the product is not used for one week or longer:

### Check beforehand

Is [Near End] or [Ink End] displayed?

- Maintenance liquid and ink is aspirated during the washing operation. Washing is not possible if an error occurs during this process. Replace with new ink.

- 1** On the LOCAL mode screen, select [MENU] > [Maintenance], then press the [ENTER] key.
  - The Maintenance menu is displayed.
- 2** Select [Station Maint.] > [Custody Wash], then press the [ENTER] key.
  - The carriage moves over the platen.



**3** Open the front cover.

**4** Clean the wiper and bracket.

-  "Wiper Cleaning"(P. 134)

**5** Press the [ENTER] key once cleaning is complete.

- "Cap Cleaning Completed (Next) [ENT]" appears on the display.

**6** Clean the cap rubber.

-  "Cap Rubber Cleaning"(P. 136)

**7** Once cleaning is complete, close the cover, then press the [ENTER] key.

- "Fill the Liquid. Exit Next [ENT]" appears on the display.

**8** Fill the cap with maintenance liquid.

- Use a syringe to draw up some maintenance liquid and fill until it almost overflows from the cap.

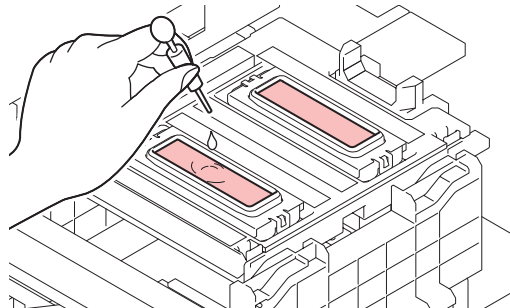

**9** Press   to enter the leaving time. (Supported from firmware version 3.2 onward)

- The recommended leaving time is 1 minute.

**10** Close the front cover, then press the [ENTER] key.

- Print nozzle washing starts. The elapsed time is displayed on the display.
- Cleaning is performed automatically once print nozzle washing has ended.
- "Fill the Liquid. Exit Next [ENT]" appears on the display.

**11** Open the front cover.

**12** Fill the cap with maintenance liquid.

- Use a syringe to draw up some maintenance liquid and fill until it almost overflows from the cap.

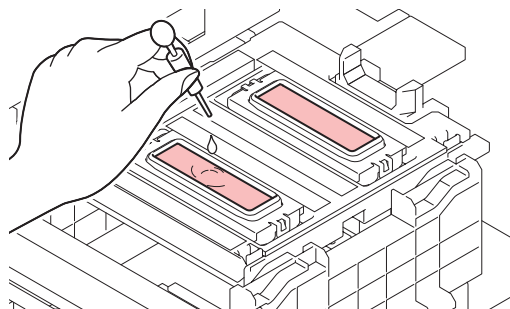

**13** Close the front cover, then press the [ENTER] key.

- Pump tube (ink discharge channel below the cap) washing starts.



- Do not turn off the main power supply. Turning off the main power supply will disable the automatic maintenance function (including nozzle clogging prevention function and waste ink draining channel cleaning function). This will increase the risk of print defects (e.g., nozzle clogging, deflection).

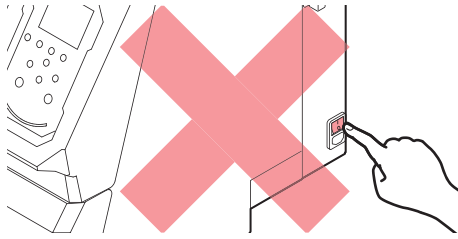

- Do not leave media loaded on the platen. This may leave irregularities or ripples in the media.



- When the machine is not in use, raise the clamp lever to separate the pinch rollers from the grit rollers. Leaving the pinch rollers in the lowered position for an extended period of time may cause the pinch rollers to become deformed. Deformation of the pinch rollers may prevent the media from being fed correctly.



- Perform the following if the "Check Waste Ink Tank" message appears on the display.  
 ["Waste Ink Tank Replacement"\(P. 156\)](#)

## 6.3 Consumable Item Replacement

To order replacement consumable items, contact your local dealer or our service office. For more information on consumable items, refer to our website (<https://mimaki.com/supply/inkjet.html>).



- Avoid storing this product in locations accessible to children.



- When disposing of the product, contact an industrial waste disposal operator or dispose of the product in accordance with the local laws and regulations.

### Wiper Replacement

This product maintains a count of the number of wiping cycles. The "Replace Wiper" message appears when a preset count is reached. Replace dirty or warped wipers with new ones.

- 1 "Replace Wiper" appears on the display.**
- 2 On the LOCAL mode screen, select [MENU] > [Maintenance], then press the [ENTER] key.**
  - The Maintenance menu is displayed.
- 3 Select [Station Maint.] > [Replace Wiper], then press the [ENTER] key.**
  - The carriage moves over the platen.
- 4 Open the front cover.**
- 5 Detach the wiper.**
  - Pull out the wiper by holding the protrusions at both ends of the wiper bracket.

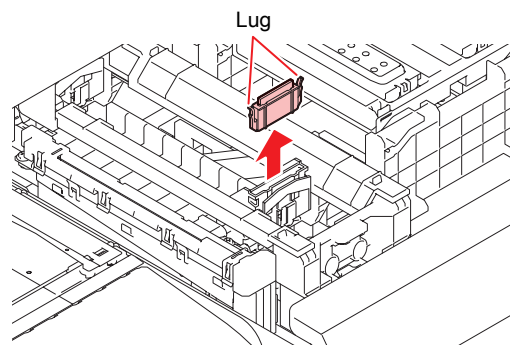

- 6 Clean the wiper slider.**
  - Wipe off any ink and dust adhering using a cleaning stick moistened with maintenance liquid. Wipe off the maintenance liquid. Make sure none remains.

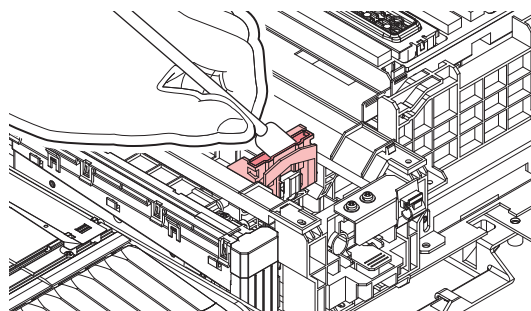

## 7 Mount a new wiper.

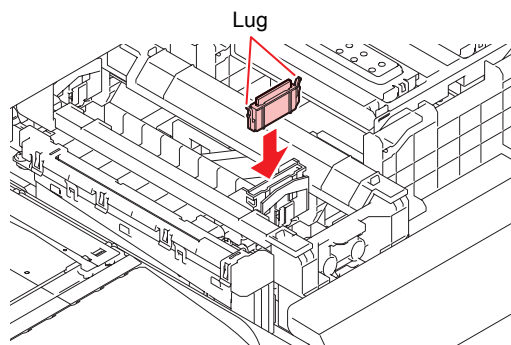

## 8 Once replacement is complete, close the cover, then press the [ENTER] key.

- The wiper usage count is reset.

## Cap Absorber Replacement

This product maintains a usage count. The "Replace Cap Absorber" message appears on the display when a preset count is reached. (This is supported in firmware version 2.5 and later.)

If the cap absorber is very dirty or if ink drips on to the media, replace with a new cap absorber.

- 1 The "Replace Cap Absorber" message appears on the display.
- 2 On the LOCAL mode screen, select [MENU] > [Maintenance], then press the [ENTER] key.
  - The Maintenance menu is displayed.
- 3 Select [Station] > [Carriage Out] > [Station Maint.], then press the [ENTER] key.
  - The carriage moves over the platen.
  - The cap absorber usage count is reset.
- 4 Turn off the power.
- 5 Open the front cover.
- 6 Remove the cap absorber.
  - Push up the two tabs at the front to remove the cap absorber.

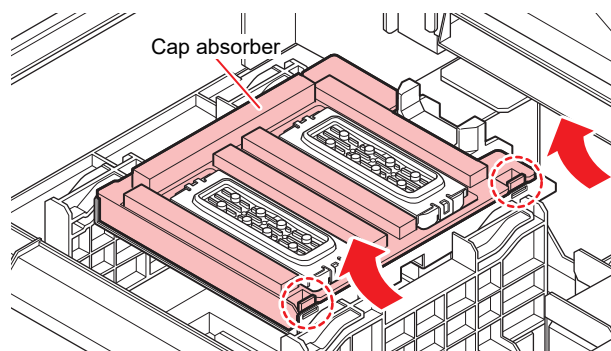

- Avoid ink dripping when removing the cap absorber.

## 7 Clean the carriage base.

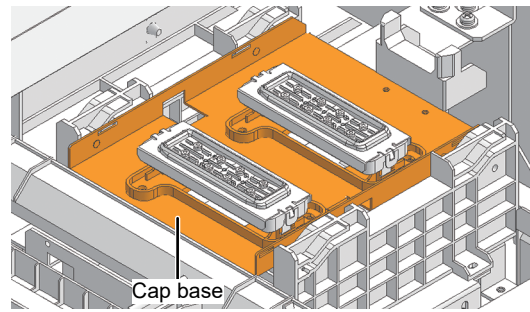

## 8 Mount a new cap absorber.

- Push the tabs on the cap absorber into the slits at the rear of the C slider, and clip in the tabs at the front.

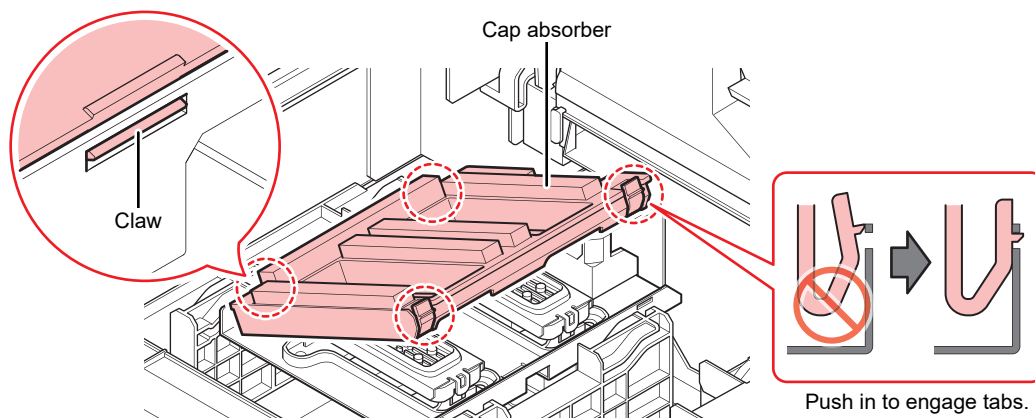

## 9 Once replacement is complete, move the wiper back to the rear by hand.

## 10 Close the front cover, then turn on the power.

- Check to confirm that the carriage returns to the station.

## Mist Filter Replacement

Check the mist filter. Replace if very dirty.

- 1** On the LOCAL mode screen, select [MENU] > [Maintenance], then press the [ENTER] key.
  - The Maintenance menu is displayed.
- 2** Select [Station] > [Carriage Out] > [Head Maint.], then press the [ENTER] key.
  - The carriage moves to the maintenance space.

### 3 Open the maintenance covers.

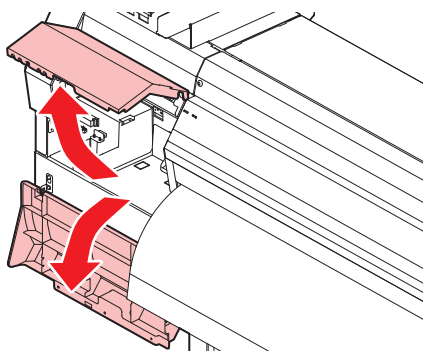

### 4 Remove the mist filter box.

- Push the tabs in the direction indicated by the arrows and slide in the direction indicated by the arrows to remove.

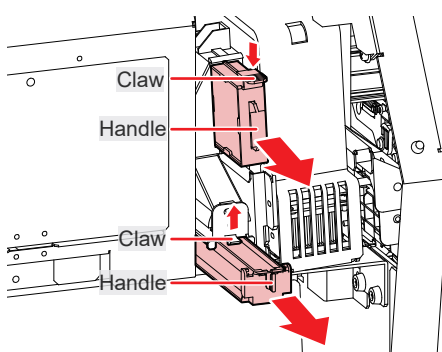

### 5 Replace the mist filter with a new one.

### 6 Mount the mist filter box.

- Insert until it clicks into place. Confirm that the tabs are engaged.

### 7 Once replacement is complete, close the cover, then press the [ENTER] key.

## LED Glass Replacement

Replace with new LED glass if the ink hardens and the existing LED glass becomes dirty.

- 1 On the LOCAL mode screen, select [MENU] > [Maintenance], then press the [ENTER] key.
  - The Maintenance menu is displayed.
- 2 Select [Station] > [Carriage Out] > [Head Maint.], then press the [ENTER] key.
  - The carriage moves to the maintenance space.

### 3 Open the maintenance covers.

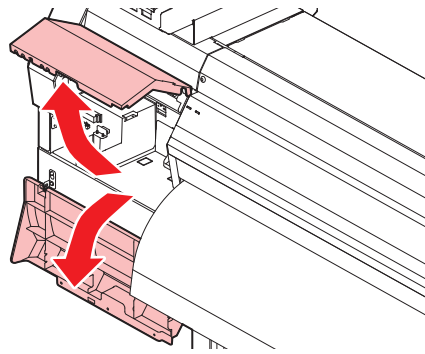

### 4 Remove the LED glass.

- Unclip the tabs and slide in the direction indicated by the arrow to remove.
- Be careful not to apply too much force when unclipping the tabs. Disregarding this precaution may cause the tabs to break.

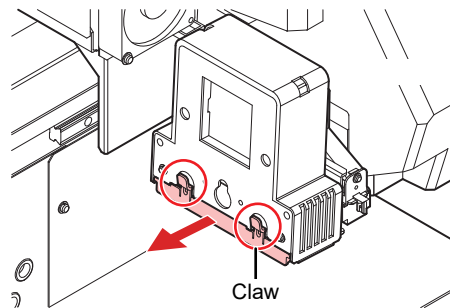

### 5 Mount a new LED glass.

- Insert until it clicks into place. Confirm that the tabs are engaged.

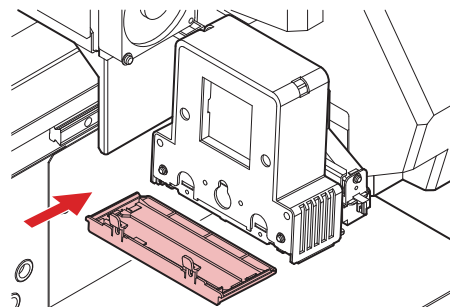

### 6 Once replacement is complete, close the cover, then press the [ENTER] key.

## Exhaust Fan Filter Replacement

Check the exhaust fan filter condition. Replace if very dirty.

## 1 Remove the exhaust fan BOX.

- Push the tabs at the front to remove the exhaust fan box.

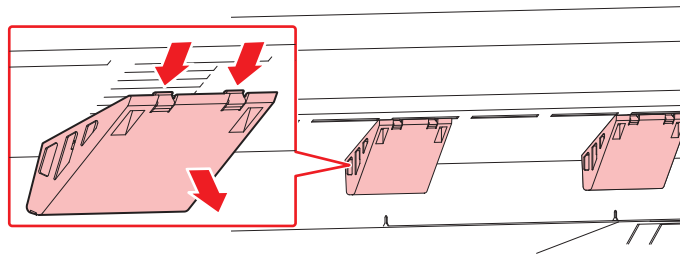

- Replace the very dirty exhaust fan box with new one.

## 2 Mount a new exhaust fan filter in the exhaust fan box.

- Press the exhaust fan filter into the space under the tabs of the exhaust fan box.

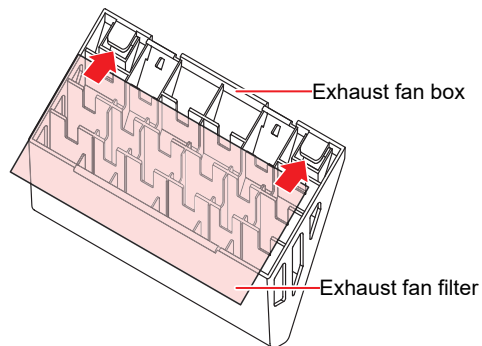

## 3 Mount the exhaust fan box.

- Insert the tabs of the exhaust fan box into the slits of the machine, and clip in the tabs at the front.

## Pinch Roller Replacement

Replace worn or dirty pinch rollers with new ones.



- Turn off the main power supply and unplug the power cable before replacing the pinch rollers.

### 1 Open the front cover.

### 2 Raise the clamp lever.



### 3 Remove the O-ring retaining the pinch rollers.

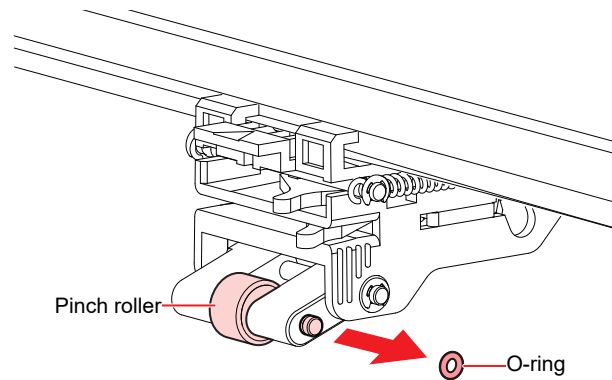

- The pinch rollers are small. Be careful to avoid dropping them into the product interior.

### 4 Remove the pinch roller spindle.

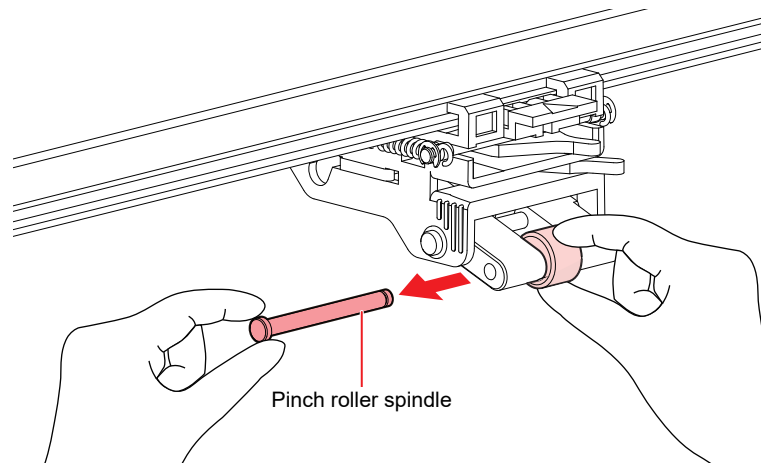

### 5 Mount new pinch rollers, and secure them using the O-ring.

### 6 Close the front cover.

## Media Holder Replacement

If the media holder becomes deformed and touches the carriage or print head, replace with a new media holder.



- Turn off the main power supply and unplug the power cable before replacing the pinch rollers.

**1** Open the maintenance covers.

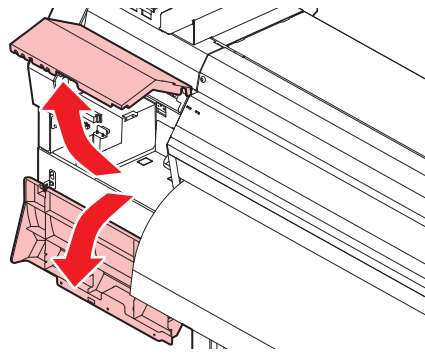

**2** Remove the side screw, and detach the media holder stopper.

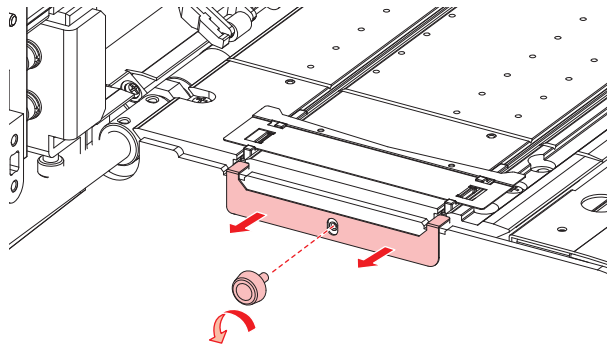

**3** Remove the media holder.

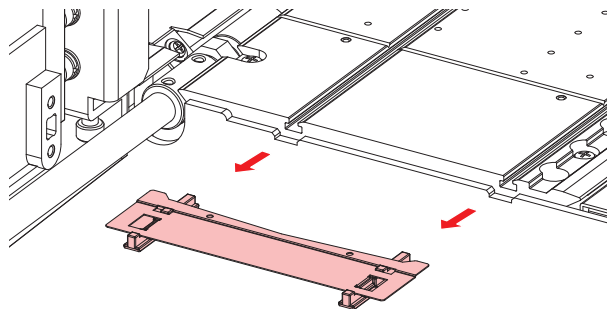

**4** Remove the sliders from the media holder.

- Be careful to avoid misplacing the sliders.

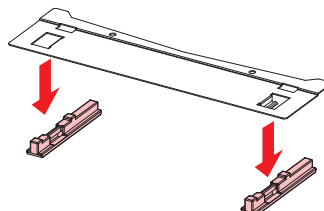

## 5 Mount the sliders on to the new media holder.

- Engage the holes in the sliders on to the lugs on the media holder.

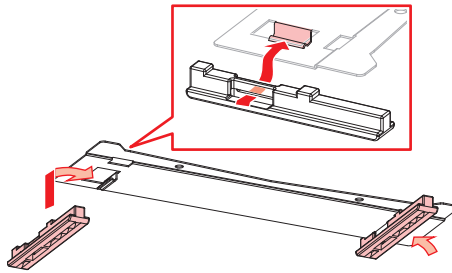

## 6 Mount the new media holder on to the platen.

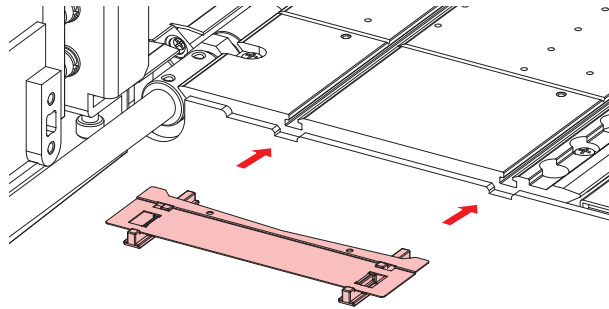

## 7 Secure the media holder stopper with the screw.

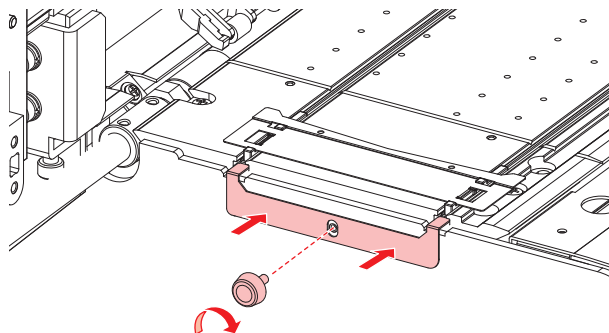

## 8 Close the maintenance covers.

### Media Cutter Replacement

Replace cutters when blades are chipped or blunt.



- Avoid touching the cutter blade. Failure to do so may result in injury.



- Avoid storing this product in locations accessible to children.

## 1 On the LOCAL mode screen, select [MENU] > [Cutting], then press the [ENTER] key.

- The Cutting menu is displayed.

**2** Select [Tool Change], then press the [ENTER] key.

- The cutter unit moves over the platen.

**3** Open the front cover.

- The cutter unit can be moved manually. Move the carriage slowly to a position allowing easy access for replacement.

**4** Replace the media cutter.

- (1) Unscrew the cutter screw.

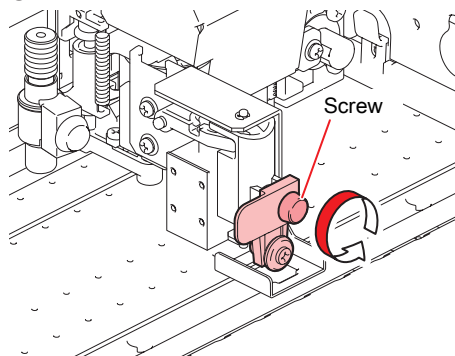

- (2) Remove the cutter.

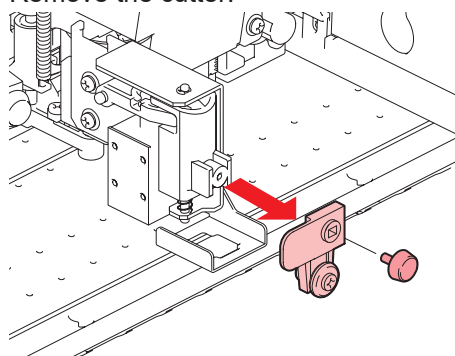

- (3) Mount a new cutter.
- (4) Tighten the screw to clamp the cutter.

**5** Once replacement is complete, close the cover, then press the [ENTER] key.

- When disposing of the product, contact an industrial waste disposal operator or dispose of the product in accordance with the local laws and regulations.

## Waste Ink Tank Replacement

Ink used during head cleaning and other processes is collected in the waste ink tank at the lower right of the machine.

This product keeps track of the waste ink level. A "Check Waste Ink Tank" message appears when the preset level is reached. Use this a guide for replacing the waste ink tank.





- For a 2-liter tank, the preset level is 80 % (1.6 L).
- Continuing to use the product without disposing of the waste ink may result in waste ink overflowing from the waste ink tank. Visually check ink levels in the waste ink tank about once a week.



- Pay close attention to ventilation and be sure to wear safety glasses, gloves, and a mask when handling ink, maintenance liquid, waste ink, or other solutions used with the machine. Leaking ink may adhere to the skin or get into the eyes or mouth.



## When "Check Waste Ink Tank" message appears

- 1** The "Check Waste Ink Tank" message appears on the display.
- 2** Check the waste ink levels in the waste ink tank.
  - If you note any discrepancies from actual levels, proceed to the next step.
  - If there is no discrepancy, replace (dispose of) the waste ink tank referring to  ["Replacing the Waste Ink Tank"\(P. 157\)](#).
- 3** On the LOCAL mode screen, select [MENU] > [Maintenance], then press the [ENTER] key.
  - The Maintenance menu is displayed.
- 4** Select [Replace Wasteinktank], then press the [ENTER] key.
  - "Replace Wasteinktank Level: 80 % (1.6 L)" appears on the display.
- 5** Press   to adjust the level.
- 6** Press the [ENTER] key once adjustment is complete.

## Replacing the Waste Ink Tank

- 1** On the LOCAL mode screen, select [MENU] > [Maintenance], then press the [ENTER] key.
  - The Maintenance menu is displayed.
- 2** Select [Replace Wasteinktank], then press the [ENTER] key.
  - "Replace Wasteinktank Level: 80 % (1.6 L)" appears on the display.
- 3** Open the waste ink tank cover.

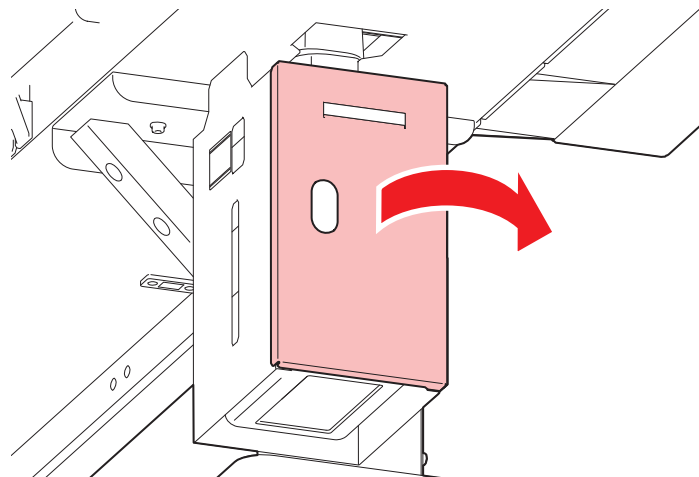

**4** Hold the handle on the waste ink tank and slide out.

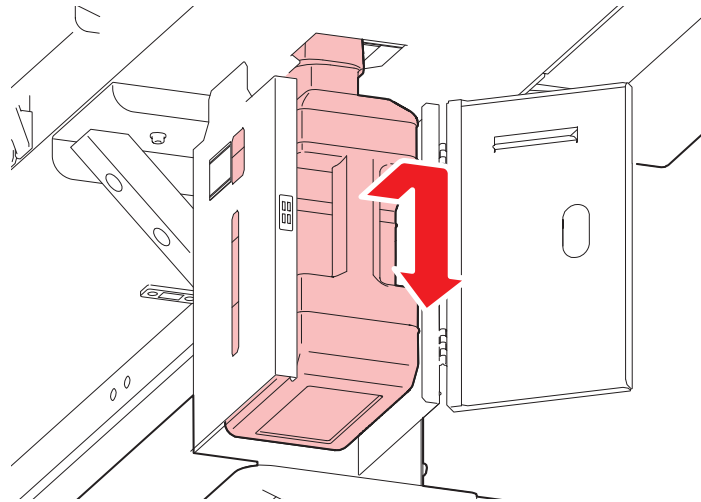

**5** Attach the cap to the removed waste ink tank, and use tape to prevent leakage of waste ink.

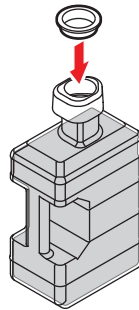

- When disposing of the product, contact an industrial waste disposal operator or dispose of the product in accordance with the local laws and regulations.

**6** Mount a new waste ink tank.

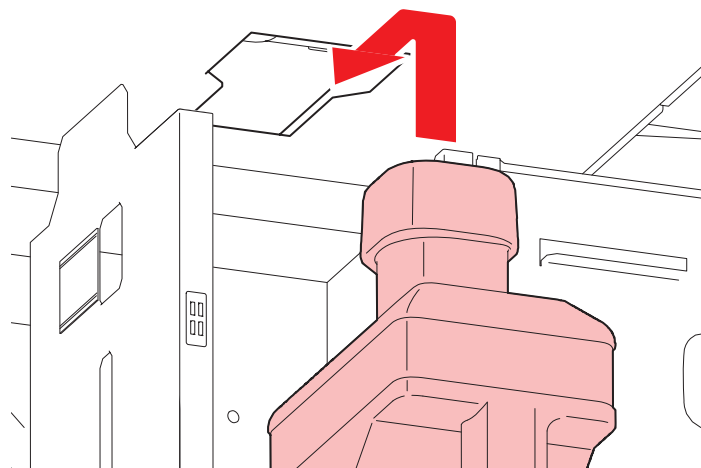

## 7 Close the waste ink tank cover.

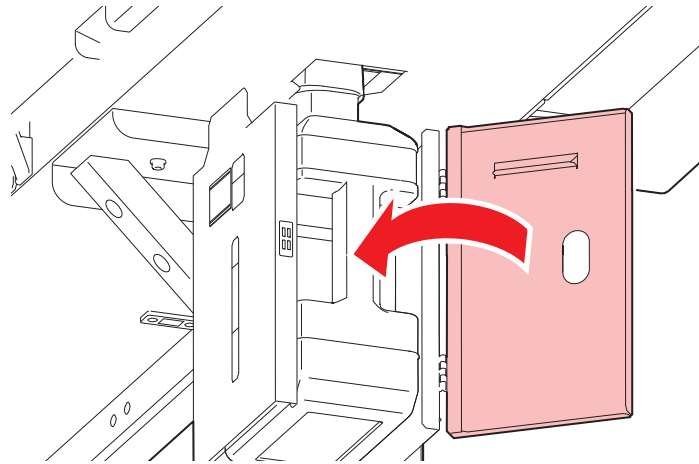

## 8 Press the [ENTER] key.

- The waste ink level will be reset.

## About the Media Cutter

Replace cutters when blades are chipped or blunt.

To order replacement consumable items, contact your local dealer or our service office.

Item	Code
Pen adapter	SPA-0169
Eccentric cutter holder	SPA-0001
Eccentric cutter holder	SPA-0090
Eccentric blade for PVC sheets	SPB-0001
Eccentric blade for small letters	SPB-0003
Eccentric blade for rubber sheets	SPB-0005
Eccentric blade for reflective sheets	SPB-0006
Eccentric blade for fluorescent sheets	SPB-0007
Low pressure eccentric blade for PVC sheets	SPB-0030
Eccentric blade for thick rubber sheets	SPB-0084

For more information on other consumable items, refer to our website. <https://mimaki.com/supply/inkjet.html>



- Avoid touching the cutter blade. Failure to do so may result in injury.
- Do not shake or swing the cutter holder. Doing so may cause the blade to come off.



- Avoid storing this product in locations accessible to children.



- When disposing of the product, contact an industrial waste disposal operator or dispose of the product in accordance with the local laws and regulations.

### ● Replacing Cutters

 ["Installing Cutting Tools"\(P. 84\)](#)

## Pen Line Replacement

This machine can be used with the following pen lines.

- Pen line rubber  
Used for pen writing or cutting
- Pen line sponge  
Used for half cut (cutting across a dotted line)

To order replacement consumable items, contact your local dealer or our service office.

Item	Code
PEN LINE RUBBER FOR 300/150-160	SPC-0770
PEN LINE RUBBER FOR 300/150-130	SPC-0771
PEN LINE RUBBER FOR 150-107	SPC-0772
PEN LINE RUBBER FOR 150-75	SPC-0773
PEN LINE SPONGE FOR 300/150-160	SPC-0775
PEN LINE SPONGE FOR 300/150-130	SPC-0776
PEN LINE RUBBER FOR 150-107	SPC-0777
PEN LINE RUBBER FOR 150-75	SPC-0778

For more information on other consumable items, refer to our website. <https://mimaki.com/supply/inkjet.html>

- 1 Open the front cover.**
- 2 Use tweezers to peel off the end of the pen line.**
  - Wipe off any adhesive remaining in the platen slot with alcohol.

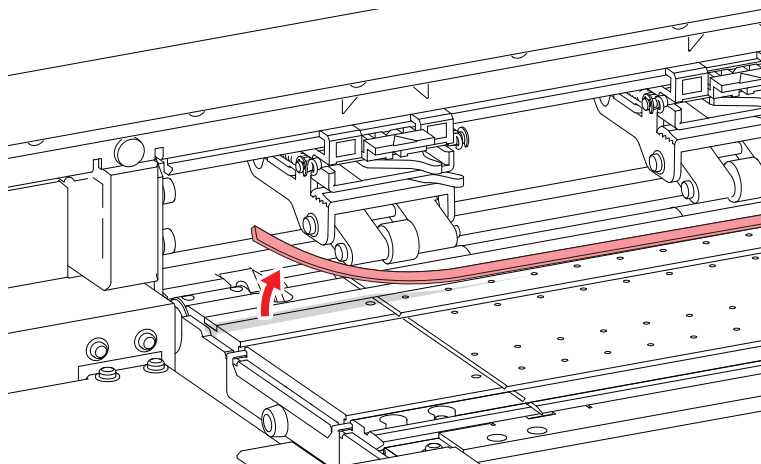

- 3 Attach double-sided tape in the platen slot.**
  - Peel off the base paper from the double-sided tape.
- 4 Attach the pen line on the double-sided tape.**
  - Make sure the pen line lies flat.
- 5 Close the front cover.**



# Chapter 7 Troubleshooting



**This chapter**

This chapter explains procedures for troubleshooting and addressing messages on the display.



Troubleshooting.....	162	Cutting Related .....	168
The power does not turn on. ....	162	Problems Causing Messages to Appear .....	174
Printing is not possible. ....	162	Warning Messages .....	174
The media jams or the media is dirty. ....	162	Ink Errors .....	176
Image Defects Occur. ....	163	Error Message .....	177
The ink has leaked out.....	168	SYSTEM HALT .....	183
The light-blocking cover comes off.....	168		

## 7.1 Troubleshooting





For information on troubleshooting, refer to this chapter. Refer to our website (<https://mimaki.com/support/>) for frequently asked questions (FAQs) about this product and customer support videos.

If the recommended corrective action does not resolve the problem, contact your local dealer or our service office.

### The power does not turn on.

Points to check	Corrective action
Is the machine connected to the power outlet by the power cable?	Connect the power plug securely to the power outlet.  <a href="#">"Connecting the Power Cable"(P. 33)</a>
Are you using the power cable provided?	Use the power cable provided.
Is the main power supply turned on?	Turn on the main power supply.  <a href="#">"Turning On the Power"(P. 33)</a>
Is the [END/POWER] key on the operating panel turned on?	Turn the power on.  <a href="#">"Turning On the Power"(P. 33)</a>

### Printing is not possible.





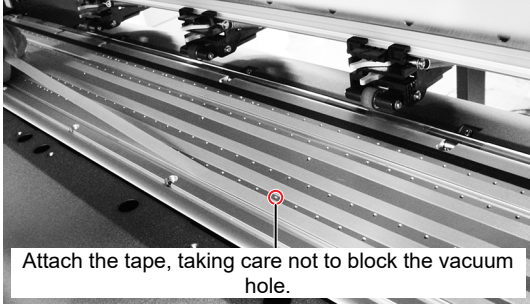

Points to check	Corrective action
Is a USB interface cable connected?	Connect the cable securely to the USB 2.0 port.  <a href="#">"Using a USB Cable"(P. 35)</a>
Is a LAN cable connected?	Connect the cable securely to the LAN port.  <a href="#">"Using a LAN Cable"(P. 35)</a>
Are you using a LAN cable approved by Mimaki?	Check the LAN cable type.  <a href="#">"Using a LAN Cable"(P. 35)</a>
Is the status lamp on the operating panel illuminated or flashing red?	An error has occurred. Check the message on the display.  <a href="#">"Operating Panel"(P. 29)</a>

### The media jams or the media is dirty.

Points to check	Corrective action
Are you using the recommended media?	Make sure you are using the recommended media. <a href="https://mimaki.com/supply/inkjet.html">https://mimaki.com/supply/inkjet.html</a>
Are you using curled media?	Do not use curled media or media with folded ends.
Is the media skewed?	Use the take-up unit to adjust the media or reload the media.  <a href="#">"Loading the Media"(P. 59)</a>



Points to check	Corrective action
Does the media have ripples/surface irregularities or lift up?	<p>If you are using roll media, use a smooth section of the media for initial feeding. You can also improve this problem by attaching the NITOFLO<sup>®</sup> tape provided on the platen.</p>  <p>Attach the tape, taking care not to block the vacuum hole.</p> <p>For more information, refer to the description on transporting media on the platen. <a href="https://mimaki.com/download/inkjet.html">https://mimaki.com/download/inkjet.html</a></p>

## Image Defects Occur.



Symptom	Corrective action
White streaks, blurriness, and dark streaks occur. (Carriage scan direction)	<ol style="list-style-type: none"> <li>1. Remove any paper scraps or other debris adhering to areas over which the head passes (e.g., media holders).  "Media Holder Cleaning"(P. 142)  "Platen Cleaning"(P. 143)</li> <li>2. Perform the procedure described in  "Head Cleaning"(P. 71).</li> <li>3. Perform the procedure described in  "Feed Correction"(P. 72).</li> <li>4. Perform the procedure described in  "Wiper Cleaning"(P. 134).</li> <li>5. Perform the procedure described in  "Cap Rubber Cleaning"(P. 136).</li> <li>6. Perform the procedure described in  "Carriage Underside Cleaning"(P. 138).</li> </ol>
Text is double- or triple-printed in the media feed direction.	<ol style="list-style-type: none"> <li>1. Perform the procedure described in  "Feed Correction"(P. 72).</li> </ol>
Offsetting occurs during bidirectional printing.	<ol style="list-style-type: none"> <li>1. Perform the procedure described in  "Correcting the Drop Position"(P. 74).</li> </ol>
Ink droplets drip during printing.	<ol style="list-style-type: none"> <li>1. Perform the procedure described in  "Wiper Cleaning"(P. 134).</li> <li>2. Perform the procedure described in  "Cap Rubber Cleaning"(P. 136).</li> <li>3. Perform the procedure described in  "Carriage Underside Cleaning"(P. 138).</li> <li>4. Perform the procedure described in  "Head Cleaning"(P. 71).</li> <li>5. Set auto maintenance.  "Maintenance Menu"(P. 115)</li> </ol>
Clear clogged nozzles.	<ol style="list-style-type: none"> <li>1. Perform the procedure described in  "Head Cleaning"(P. 71).</li> <li>2. Perform the procedure described in  "Print Head Nozzle Washing"(P. 163).</li> <li>3. Perform [MENU] &gt; [Maintenance] &gt; [INK FILL].</li> <li>4. Perform the procedure described in  "Wiper Replacement"(P. 147).</li> <li>5. Perform the procedure described in  "Registering Nozzle Recovery"(P. 116).</li> </ol>

## Print Head Nozzle Washing

If ejection failures (e.g., nozzle clogging or deflection) remain unresolved even after head cleaning ( "Head Cleaning"(P. 71)), apply nozzle washing to the print head.

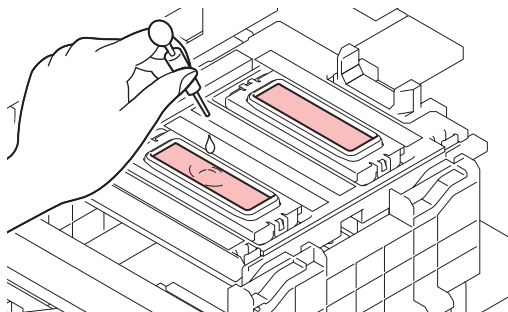
- 1** On the LOCAL mode screen, select [MENU] > [Maintenance], then press the [ENTER] key.
  - The Maintenance menu is displayed.
- 2** Select [Station Maint.] > [Nozzle Wash], then press the [ENTER] key.
  - The carriage moves over the platen.
- 3** Open the front cover.
- 4** Clean the wiper and bracket.
  -  "Wiper Cleaning"(P. 134)
- 5** Press the [ENTER] key once cleaning is complete.
  - "Cap Cleaning Completed (Next) [ENT]" appears on the display.
- 6** Clean the cap rubber.
  -  "Cap Rubber Cleaning"(P. 136)
- 7** Once cleaning is complete, close the cover, then press the [ENTER] key.
  - "Fill the Liquid. Exit Next [ENT]" appears on the display.
- 8** Fill the cap with maintenance liquid.
  - Use a syringe to draw up some maintenance liquid and fill until it almost overflows from the cap.



- 9** Press   to enter the leaving time. (Supported from firmware version 3.2 onward)
  - When using ML007 maintenance liquid: Recommended time is 1 minute.
  - When using ML016 maintenance liquid: Soak for 5 to 10 minutes depending on the state of the nozzle, and soak for longer if not cleaned.
- 10** Close the front cover, then press the [ENTER] key.
  - Print nozzle washing starts. The elapsed time is displayed on the display.
  - Cleaning is performed automatically once print nozzle washing has ended.



- If ejection failures (e.g., nozzle clogging or deflection) remain unresolved even after washing the nozzles several times, contact your local dealer or our service office.

## Ink colors are mixed.



- Pay close attention to ventilation and be sure to wear safety glasses, gloves, and a mask when handling ink, maintenance liquid, waste ink, or other solutions used with the machine. Leaking ink may adhere to the skin or get into the eyes or mouth.



- 1** On the LOCAL mode screen, select [MENU] > [Maintenance], then press the [ENTER] key.
  - The Maintenance menu is displayed.
- 2** Select [Air PG], then press the [ENTER] key.
- 3** Select the checkbox corresponding to the head to be air-purged. (This does not apply to the UCJV150 Series.)
  - The checked head becomes the air purge target.
  - With the 300 Series, you can simultaneously select Head 1 and Head 2.

Ink set	Head 1				Head 2			
4-color	C	M	Y	K	Y	K	M	C
6 colors + W	C	M	Y	K	Lm	Lc	W	W
4 colors + CL + W	C	M	Y	K	CL	CL	W	W
4 colors + W	C	C	M	M	Y	K	W	W

- 4** Press the [ENTER] key.
  - The target head moves over the wiper.
- 5** Open the front cover.
- 6** Open the lid on the front of the carriage.
  - Remove the screw, then slowly lower the lid.

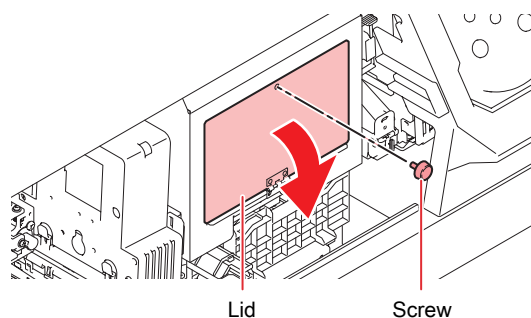

## 7 Remove the cap on the target port.

- If you select Head 1 and Head 2 simultaneously, remove the cap on the port of the head displayed at the upper right of the display.
- Turn the cap 30° counterclockwise and remove.
- No ink spills out even if the cap is removed.
- Ink adheres to the removed cap. Place on a paper towel to avoid contaminating the surrounding area.
- Purge air from the print heads one by one. Do not remove the cap on Head 2 when performing air purge for Head 1.

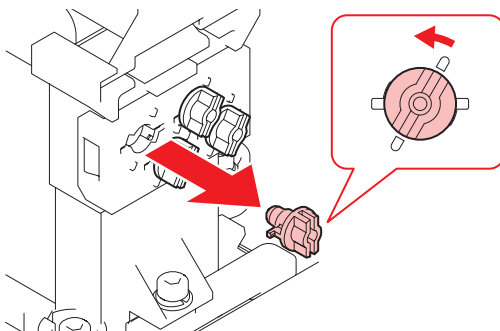

Model	Ink set	Head 1	Head 2
UCJV300	4 colors: CMYK YKMC		
	6 colors + W: CMYK LmLcWW		
	4 colors + CL + W: CMYK CLCLWW		
	4 colors + W: CCMM YKWW		
UCJV150	4 colors: CMYK		N/A

## 8 Connect the jig to the port.

- Lift the lid on the front of the carriage and pull out the jig.

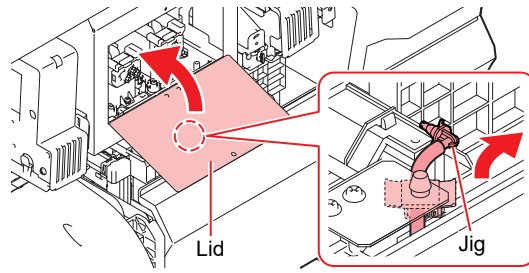

- Connect the jig by pushing the tip into the port and rotating 30° clockwise.

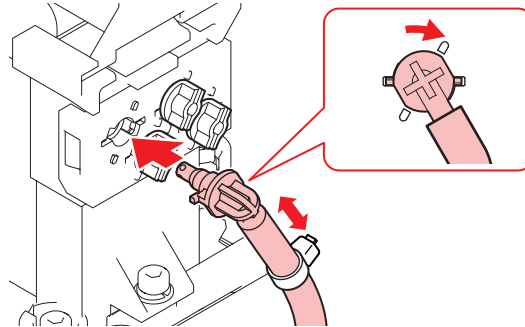

## 9 Press the [ENTER] key to start the air purge.

## 10 Check to confirm ink flows in the tube of the jig.

- Continue air purge until no mixed ink colors or air remains. Remove the jig and press the [ENTER] key to end the air purge.
- Air purge will stop automatically after 30 seconds. To continue the air purge, select [Retry].



- Do not repeat any of these operations for the same port. Doing so may lead to nozzle clogging. End the air purge when no mixed ink colors or air remains.



- During air purge, press [FUNC2] to force ink discharge for three seconds.

## 11 Repeat the above procedure for the other target ports.

## 12 Press the [ENTER] key once the air purge is complete.

## 13 Remove the jig from the port.

- Turn the jig 30° counterclockwise and remove.

## 14 Attach the cap to the port.



- Vertically lift the tip of the jig and drain the ink from the tube. Any ink left in the tube may harden.

## 15 Close the lid on the front of the carriage.

**16** Close the front cover, then press the [ENTER] key.

- Cleaning starts automatically.
- If you select Head 1 and Head 2 simultaneously, follow the instructions on the display to perform the air purge.

**The ink has leaked out**

- If an ink leak occurs, turn off the main power immediately and unplug the power cable. Then, contact your local dealer or our service office.

**The light-blocking cover comes off.**

If the light-blocking cover comes loose, the ink inside the tank may be exposed to light and begin to harden. If the light-blocking cover comes loose, reattach as follows:

- 1** Insert the lug on one side of the light-blocking cover into the corresponding hole in the tank.

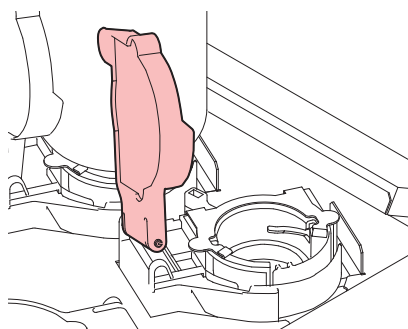

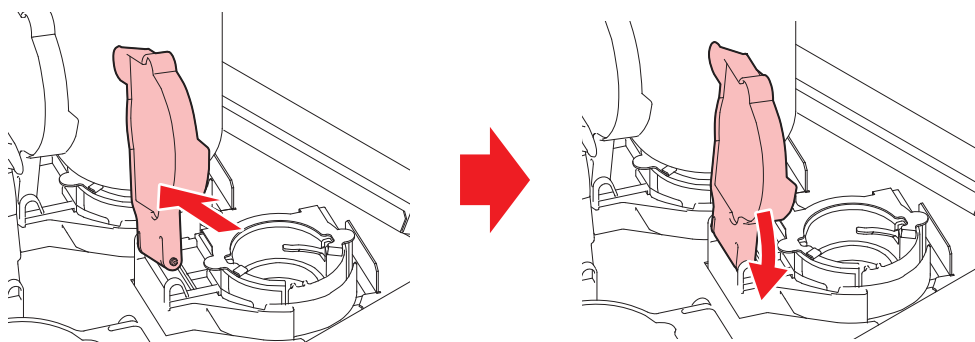

- 2** Insert the lug on the other side while pushing in toward the first hole in Step 1.





**Cutting Related**

Symptom	Corrective action
The cut position shifts.	This may indicate a problem with the register mark sensor. Perform the operation used to check the responsiveness of the register mark sensor. You cannot check the responsiveness of the register mark sensor manually.  <a href="#">"Adjusting the Position of the Register Mark Sensor"(P. 169)</a>
Cutting is not possible.	Cut a sample stored in the machine to identify the cause. Executing a sample cut will clear any data saved in the receive buffer.



Symptom	Corrective action
	 <a href="#">"Investigating the Cause of Cutting Failures"(P. 171)</a>
The print and cut positions are misaligned.	Use the MIMAKI RIP software (RasterLink) to print a correction pattern. Check the correction pattern and input correction values manually.  <a href="#">"Adjusting to Correct Misalignment Between Printing and Cutting"(P. 171)</a>
The print and cut positions are misaligned in the scan direction.	Print the correction pattern to perform automatic correction. <ol style="list-style-type: none"> <li>Position the media. <ul style="list-style-type: none"> <li>Prepare white media used to print a correction pattern.</li> </ul> </li> <li>On the LOCAL mode screen, select [MENU] &gt; [Cutting], then press the [ENTER] key. <ul style="list-style-type: none"> <li>The Cutting menu is displayed.</li> </ul> </li> <li>Select [Maintenance] &gt; [Scale Adjust], then press the [ENTER] key.</li> <li>When the confirmation screen is displayed, press the [ENTER] key. <ul style="list-style-type: none"> <li>Print the correction pattern to perform automatic correction.</li> </ul> </li> </ol>

## Adjusting the Position of the Register Mark Sensor

- 1 Prepare the media on which register marks are printed.**
  -  ["Creating Register Marks"\(P. 100\)](#)
- 2 On the LOCAL mode screen, select [MENU] > [Cutting], then press the [ENTER] key.**
  - The Cutting menu is displayed.
- 3 Select [Maintenance] > [Marks Sensor] > [Sensor Check], then press the [ENTER] key.**
  - The cutting unit moves over the platen.
- 4 Press     to move the LED pointer.**

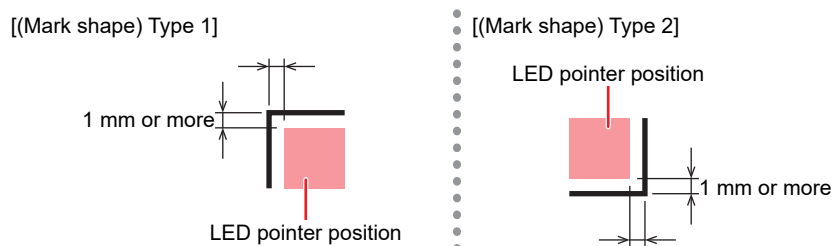

- 5 Register the information corresponding to the printed register mark conditions.**
  -  ["Setting Mark Detection Conditions"\(P. 105\)](#)
  - The set register mark conditions are also stored in [Cutting] > [Mark Detect]. The settings are retained even when the power is turned off.

## 6 Press [ENTER] to start the detection operation.

- The machine automatically detects the lines in the X and Y directions (automatic detection operation: plus X direction > minus X direction > plus Y direction > minus Y direction).

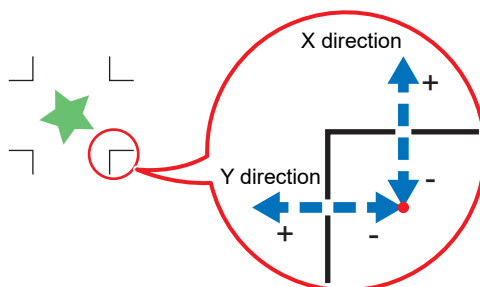

- A buzzer sounds each time a line is detected (four buzzers in all). If any of the buzzers fails to sound, refer to the following:

["Correcting the LED Pointer Position"\(P. 170\)](#)

## Correcting the LED Pointer Position

If the register marks cannot be read properly, the register mark sensor may be misaligned. Refer to the following to correct the position of the register mark sensor:

- 1 Attach a pen to the tool holder.**
  - ["Using a Pen"\(P. 88\)](#)
- 2 Load copy paper.**
- 3 On the LOCAL mode screen, select [MENU] > [Cutting], then press the [ENTER] key.**
  - The Cutting menu is displayed.
- 4 Select [Maintenance] > [Marks Sensor] > [Pointer Offset], then press the [ENTER] key.**
  - A 10 mm cross pattern is drawn.
  - The LED pointer turns on and moves to the center of the cross pattern.
- 5 Press to move the LED pointer to the center of the cross pattern.**

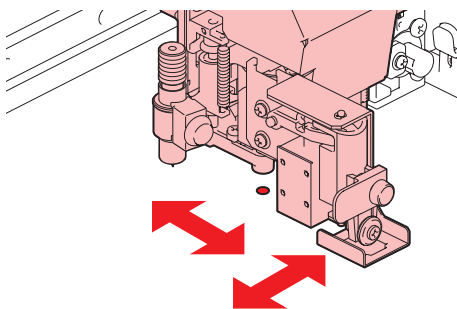

## 6 Press the [ENTER] key to complete the settings.

- The settings are retained even if [Setup Reset] is selected.

## 7 Check the following again.

- ["Adjusting the Position of the Register Mark Sensor"\(P. 169\)](#)
- If the buzzer does not sound four times, check the printed register mark conditions and contact your local distributor, our sales office, or service center.

## Investigating the Cause of Cutting Failures

- 1 On the LOCAL mode screen, select [MENU] > [Cutting], then press the [ENTER] key.
  - The Cutting menu is displayed.

- 2 Select [Maintenance] > [Sample Cut], then press the [ENTER] key.

- 3 Select the sample data, then press the [ENTER] key.

- There are two sample types: "Cut" and "Logo".



- If you select "Cut", press the [ENTER] key to start cutting.
- If you select "Logo", refer to the following:
  - (1) Press ▲ ▼ to specify the scaling factor (1 to 999 %).
  - (2) Press the [ENTER] key to start cutting
    - The settings are retained even if [Setup Reset] is selected.

### ● Sample Cut Results

- Sample data can be cut properly, but not other data.
  - There is a problem with the host PC.
- Sample data as well as other data cannot be cut properly.
  - There is a problem with the printer. Increase the pressure in the Adj-prs Offset menu. 🗨️ "Cutting Menu"(P. 125)

## Adjusting to Correct Misalignment Between Printing and Cutting

In the procedure described below, MIMAKI RIP software (RasterLink) is used to print a correction pattern. When printing and cutting, correction is required for each resolution in the scan (Y) direction. (The corrected value is saved for each resolution.) Print a pattern for each resolution, then input the correction value.

- 1 Switch the machine to REMOTE mode.

- 2 Set the print conditions (profile/cut conditions) for the job you want to print in RasterLink.

- Specify the following settings by clicking the function icons shown on the right-hand side of the screen:

 (General Print): Specifies settings like enlargement/reduction and rotation.

 (Quality): Selects a color profile for the media and ink set loaded in this machine.



- For more information, refer to the RasterLink reference guide. <https://mimaki.com/download/software.html>

**3** Click  (General Print) and click on [Print & Cut origin adjust] on the [Cut Edit] tab.

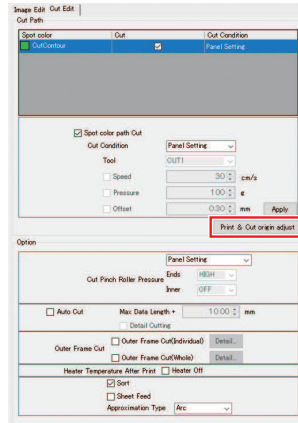

**Important!** • Note that the input units vary depending on whether or not register marks are used.

### Without register marks

**1** Click [OK] to print a correction pattern.

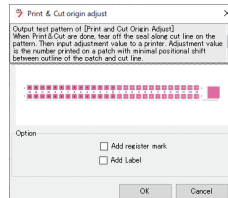

**2** On the REMOTE mode screen, select [Adjust].

**3** Select [PC Origin Offset], then press the [ENTER] key.

• A correction pattern is cut. Detach the cut part of the pattern and check the adjustment values.

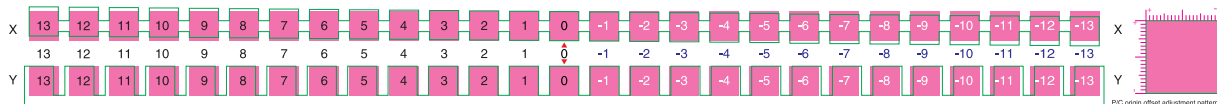

**4** Input the numerical value of the position with the lowest vertical misalignment.

• Enter "-4", as shown in the illustration below.



**5** Input the numerical value of the position with the lowest horizontal misalignment.

• Enter "2", as shown in the illustration below.



## With register marks

### 1 Select [Add register mark].

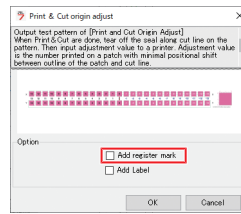

### 2 Click [OK] to print a correction pattern.

### 3 On the REMOTE mode screen, select [Adjust].

### 4 Select [TP Offset], then press the [ENTER] key.

- The register marks are detected, and a correction pattern is cut. Detach the cut part of the pattern and check the adjustment values.

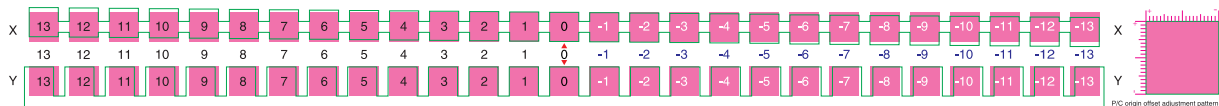

### 5 Input the numerical value of the position with the lowest vertical misalignment.

- Enter "-0.4 mm" as "-4", as shown in the illustration below.

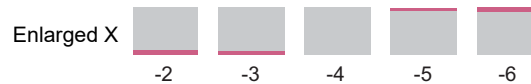

### 6 Input the numerical value of the position with the lowest horizontal misalignment.

- Enter "0.2 mm" as "2", as shown in the illustration below.

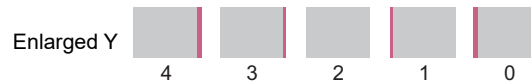







## 7.2 Problems Causing Messages to Appear

If a problem arises, the buzzer sounds and a message appears on the display.

You can also check the local guidance.  ["Displaying Machine Information \(Local Guidance\)"\(P. 32\)](#)

Take the appropriate action in accordance with the content of the message. If a message reappears even after taking the prescribed action, contact your local dealer or our service office.

### Warning Messages

Message	Cause	Corrective action
MOTOR POWER OFF	<ul style="list-style-type: none"> <li>The motor stops due to some action causing initialization—for example, opening the cover.</li> </ul>	<ul style="list-style-type: none"> <li>Wait until the initialization operation is complete.</li> </ul>
Replace NCU Ink Pad	<ul style="list-style-type: none"> <li>The ink absorber needs to be replaced.</li> </ul>	<ul style="list-style-type: none"> <li>The NCU ink absorber must be replaced. Contact your local distributor, our sales office, or service center.</li> </ul>
NCU Error NozzleCheckOFF	<ul style="list-style-type: none"> <li>An error occurred during the nozzle check. Printing stopped. The nozzle check function was disabled.</li> </ul>	<ul style="list-style-type: none"> <li>Contact your local distributor, our sales office, or service center.</li> </ul>
Nozzle Missing Print Stopped	<ul style="list-style-type: none"> <li>Nozzle clogging was detected. Printing stopped.</li> </ul>	<ul style="list-style-type: none"> <li>Perform cleaning or change the conditions for the nozzle check function. If the message is displayed again, perform nozzle recovery.  <a href="#">"Head Cleaning"(P. 71)</a>  <a href="#">"Nozzle check menu"(P. 123)</a>  <a href="#">"Registering Nozzle Recovery"(P. 116)</a></li> </ul>
Replace NCU	<ul style="list-style-type: none"> <li>A problem was detected with the nozzle clogging assessment.</li> </ul>	<ul style="list-style-type: none"> <li>The NCU must be replaced. Contact your local distributor, our sales office, or service center.</li> </ul>
NCU Sensor Lv Low	<ul style="list-style-type: none"> <li>The sensor's sensitivity is impaired.</li> </ul>	<ul style="list-style-type: none"> <li>Clean the NCU.  <a href="#">"NCU Cleaning"(P. 137)</a></li> </ul>
NCU Sens Adj Err H	<ul style="list-style-type: none"> <li>Sensor sensitivity adjustment failed.</li> </ul>	<ul style="list-style-type: none"> <li>Replace the NCU if the error does not clear. Contact your local distributor, our sales office, or service center.</li> </ul>
NCU Sens Adj Err L		
NCU Connect	<ul style="list-style-type: none"> <li>A problem was detected with the NCU connection.</li> </ul>	<ul style="list-style-type: none"> <li>Turn off the power on the machine and turn it on after a while.  <a href="#">"Turning Off the Power"(P. 34)</a></li> </ul>
NCU NzK Chk (Hw) NozzleCheckOFF	<ul style="list-style-type: none"> <li>A problem was detected with the nozzle clogging assessment.</li> </ul>	<ul style="list-style-type: none"> <li>Clean the NCU.  <a href="#">"NCU Cleaning"(P. 137)</a></li> </ul>
NCU NzK Chk (Mark) NozzleCheckOFF		
NCU CENTER POS NozzleCheckOFF	<ul style="list-style-type: none"> <li>Printing position adjustment failed.</li> </ul>	
NCU FLUSH POS		

Message	Cause	Corrective action
NozzleCheckOFF		
NCU SN Adjst NozzleCheckOFF	<ul style="list-style-type: none"> <li>• Sensor sensitivity adjustment failed.</li> </ul>	
Ink Error	<ul style="list-style-type: none"> <li>• An ink error occurred.</li> </ul>	<ul style="list-style-type: none"> <li>• Check the ink error details.  <a href="#">"Ink Errors"(P. 176)</a></li> </ul>
COVER OPEN	<ul style="list-style-type: none"> <li>• The cover is open.</li> </ul>	<ul style="list-style-type: none"> <li>• Close the cover.</li> </ul>
Replace Cap Absorber	<ul style="list-style-type: none"> <li>• The capping count exceeded the preset value.</li> </ul>	<ul style="list-style-type: none"> <li>• Replace and clean the cap absorber, then reset the count.  <a href="#">"Cap Absorber Replacement"(P. 148)</a></li> </ul>
Lower the clamp lever	<ul style="list-style-type: none"> <li>• The clamp lever is raised.</li> </ul>	<ul style="list-style-type: none"> <li>• Lower the clamp lever.  <a href="#">"Front"(P. 24)</a></li> </ul>
Data Remain	<ul style="list-style-type: none"> <li>• Print (RIP) data was received.</li> </ul>	<ul style="list-style-type: none"> <li>• Switch to REMOTE mode and start printing or clear the data and abort printing.</li> </ul>
Temporary Suspension	<ul style="list-style-type: none"> <li>• Printing has been paused.</li> </ul>	<ul style="list-style-type: none"> <li>• Switch to REMOTE mode and resume printing or clear the data and abort printing.</li> </ul>
Can'tPrint/Ink IC	<ul style="list-style-type: none"> <li>• An unusable ink IC chip is used.</li> </ul>	<ul style="list-style-type: none"> <li>• Replace with new ink and a new ink IC chip.</li> </ul>
No Media	<ul style="list-style-type: none"> <li>• No media is loaded, or the sensors are faulty.</li> </ul>	<ul style="list-style-type: none"> <li>• Load the media.  <a href="#">"Loading the Media"(P. 59)</a></li> <li>• Clean the media sensor.  <a href="#">"Media Sensor Cleaning"(P. 141)</a></li> </ul>
Please load media	<ul style="list-style-type: none"> <li>• No media is loaded, or the sensors are faulty.</li> </ul>	<ul style="list-style-type: none"> <li>• Load the media.  <a href="#">"Loading the Media"(P. 59)</a></li> </ul>
Media Undetected	<ul style="list-style-type: none"> <li>• The media width has not been detected.</li> </ul>	<ul style="list-style-type: none"> <li>• Detect the media width.  <a href="#">"Loading the Media"(P. 59)</a></li> </ul>
Replace Wiper	<ul style="list-style-type: none"> <li>• The wiping count exceeded the preset value.</li> </ul>	<ul style="list-style-type: none"> <li>• Replace the wiper, then reset the count.  <a href="#">"Wiper Replacement"(P. 147)</a></li> </ul>
Wiper Move Failure	<ul style="list-style-type: none"> <li>• The wiper is not operating correctly.</li> </ul>	<ol style="list-style-type: none"> <li>1. Clean the wiper and around the wiper.  <a href="#">"Wiper Cleaning"(P. 134)</a></li> <li>2. Turn off the power on the machine and turn it on after a while.  <a href="#">"Turning Off the Power"(P. 34)</a></li> </ol>
Replace Wasteinktank	<ul style="list-style-type: none"> <li>• The waste ink tank count exceeded the preset value (90%).</li> </ul>	<p>Automatic maintenance is not possible while the covers are open. Perform the following steps:</p> <ol style="list-style-type: none"> <li>1. Check the waste ink levels in the waste ink tank.  <a href="#">"When "Check Waste Ink Tank" message appears"(P. 157)</a></li> <li>2. Replace the waste ink tank, then reset the waste ink level.  <a href="#">"Replacing the Waste Ink Tank"(P. 157)</a></li> </ol>
Check Waste Ink tank	<ul style="list-style-type: none"> <li>• The waste ink tank count exceeded the preset value (80 %).</li> </ul>	<ol style="list-style-type: none"> <li>1. Check the waste ink levels in the waste ink tank.  <a href="#">"When "Check Waste Ink Tank" message appears"(P. 157)</a></li> <li>2. Replace the waste ink tank, then reset the waste ink level.  <a href="#">"Replacing the Waste Ink Tank"(P. 157)</a></li> </ol>









Message	Cause	Corrective action
High machine temp. ** ° C	<ul style="list-style-type: none"> <li>Ambient temperatures are too high.</li> </ul>	<ul style="list-style-type: none"> <li>Adjust ambient temperatures to temperatures within the specified range. Optimum print quality may not be possible unless ambient conditions are within the specified range.  <a href="#">"Installation Precautions"(P. 16)</a></li> </ul>
Low machine temp. ** ° C	<ul style="list-style-type: none"> <li>Ambient temperatures are too low.</li> </ul>	
Perform an air purge.	<ul style="list-style-type: none"> <li>The message is displayed every month to keep ink inside the ink routes from hardening.</li> </ul>	<ul style="list-style-type: none"> <li>Perform an air purge.  <a href="#">"Ink colors are mixed."(P. 165)</a></li> </ul>
Battery Exchange	<ul style="list-style-type: none"> <li>The internal clock battery is spent and must be replaced.</li> </ul>	<ul style="list-style-type: none"> <li>Contact your local distributor, our sales office, or service center.</li> </ul>
CLAMP UP	<ul style="list-style-type: none"> <li>The clamp lever is lifted.</li> </ul>	<ul style="list-style-type: none"> <li>Lower the clamp lever.</li> </ul>

## Ink Errors

Message	Cause	Corrective action
Ink End	<ul style="list-style-type: none"> <li>The ink has run out.</li> </ul>	<ul style="list-style-type: none"> <li>Replace with new ink.  <a href="#">"When Ink End is Displayed"(P. 41)</a></li> </ul>
Ink Near End	<ul style="list-style-type: none"> <li>Ink levels are low.</li> </ul>	<ul style="list-style-type: none"> <li>The ink will run out soon. Have new ink ready.  <a href="#">"When Ink Near End is Displayed"(P. 41)</a></li> </ul>
Non Ink IC	<ul style="list-style-type: none"> <li>No ink IC chip was detected.</li> </ul>	<ol style="list-style-type: none"> <li>Set the ink IC chip. Inserting the Ink IC Chip</li> <li>Check to confirm the ink IC chip was inserted correctly. Inserting the Ink IC Chip</li> <li>Turn off the power on the machine and turn it on after a while.  <a href="#">"Turning Off the Power"(P. 34)</a></li> </ol>
Wrong Ink IC	<ul style="list-style-type: none"> <li>An error occurred with the information on the ink IC chip.</li> </ul>	<ol style="list-style-type: none"> <li>Check to confirm the ink IC chip was inserted correctly. Inserting the Ink IC Chip</li> <li>Turn off the power on the machine and turn it on after a while.  <a href="#">"Turning Off the Power"(P. 34)</a></li> <li>Replace with new ink.  <a href="#">"Replacing Ink"(P. 42)</a></li> </ol>
Ink Color	<ul style="list-style-type: none"> <li>The ink color registered on the IC chip is different from the ink color filled.</li> </ul>	<ul style="list-style-type: none"> <li>Insert an ink IC chip for the correct ink color. Inserting the Ink IC Chip</li> </ul>
Ink Type	<ul style="list-style-type: none"> <li>The ink type registered on the IC chip is different from the ink type filled.</li> </ul>	<ul style="list-style-type: none"> <li>Insert an ink IC chip for the correct ink type. Inserting the Ink IC Chip</li> </ul>
Expiration	<ul style="list-style-type: none"> <li>The ink has expired.</li> </ul>	<ul style="list-style-type: none"> <li>Replace with new ink or use up as quickly as possible. Printing is possible.  <a href="#">"When Ink End is Displayed"(P. 41)</a></li> </ul>
Expiration:1MONTH	<ul style="list-style-type: none"> <li>The ink is one month past its expiration date and cannot be used.</li> </ul>	<ul style="list-style-type: none"> <li>Replace with new ink or use up as quickly as possible. Printing is possible.  <a href="#">"When Ink End is Displayed"(P. 41)</a></li> </ul>
Expiration:2MONTH	<ul style="list-style-type: none"> <li>The ink is two months past its expiration date and cannot be used.</li> </ul>	<ul style="list-style-type: none"> <li>Replace with new ink. Printing is not possible.  <a href="#">"When Ink End is Displayed"(P. 41)</a></li> </ul>

















## Error Message

Error number	Message	Cause	Corrective action
108	HD THERMIS [1234]	<ul style="list-style-type: none"> <li>A problem was detected with print head temperature control.</li> </ul>	<ul style="list-style-type: none"> <li>Turn off the power on the machine and turn it on after a while.  <a href="#">"Turning Off the Power"(P. 34)</a></li> </ul>
108	HD CONNECT [1234]	<ul style="list-style-type: none"> <li>A problem was detected with the print head connection.</li> </ul>	
108	HD MEM EMP [1234]	<ul style="list-style-type: none"> <li>A problem was detected with the print head.</li> </ul>	
108	HD TYPE [1234]		
122	CHECK:SDRAM	<ul style="list-style-type: none"> <li>A problem was detected with the SDRAM.</li> </ul>	<ul style="list-style-type: none"> <li>Turn off the power on the machine and turn it on after a while.  <a href="#">"Turning Off the Power"(P. 34)</a></li> </ul>
128	HDC FIFO OVER	<ul style="list-style-type: none"> <li>A problem was detected with the print head control PCB.</li> </ul>	
128	HDC FIFO UNDER		
12a	HDC SPEED	<ul style="list-style-type: none"> <li>A problem was detected with the print head control.</li> </ul>	<ul style="list-style-type: none"> <li>Turn off the power on the machine and turn it on after a while.  <a href="#">"Turning Off the Power"(P. 34)</a></li> </ul>
130	HD DATA SEQ		
148	E-LOG SEQ	<ul style="list-style-type: none"> <li>A log control abnormality was detected.</li> </ul>	<ul style="list-style-type: none"> <li>Turn off the power on the machine and turn it on after a while.  <a href="#">"Turning Off the Power"(P. 34)</a></li> </ul>
151	Main PCB V1R2	<ul style="list-style-type: none"> <li>A problem was detected with the main PCB power supply circuit.</li> </ul>	<ul style="list-style-type: none"> <li>Turn off the power on the machine and turn it on after a while.  <a href="#">"Turning Off the Power"(P. 34)</a></li> </ul>
152	Main PCB V2R5		
153	Main PCB V3R3		
154	Main PCB V05		
155	Main PCB V36-1		
157	Main PCB VTT		
158	Main PCB V36-2		
15f	HEAD DRIVE HOT	<ul style="list-style-type: none"> <li>The COM drive has overheated.</li> </ul>	<ul style="list-style-type: none"> <li>Turn off the power on the machine and turn it on after a while.  <a href="#">"Turning Off the Power"(P. 34)</a></li> </ul>
16e	Main PCB V3R3B	<ul style="list-style-type: none"> <li>A problem was detected with the main PCB power supply circuit.</li> </ul>	
171	NEW HEAD CONNECT	<ul style="list-style-type: none"> <li>A new print head connection was detected.</li> </ul>	
18a	Main PCB V_CORE	<ul style="list-style-type: none"> <li>A problem was detected with the main PCB power supply.</li> </ul>	<ul style="list-style-type: none"> <li>Turn off the power on the machine and turn it on after a while.  <a href="#">"Turning Off the Power"(P. 34)</a></li> </ul>
18b	Main PCB V1R5B		
18c	Main PCB V12		
18e	FLS NOT COMP	<ul style="list-style-type: none"> <li>A problem was detected with the print head control.</li> </ul>	<ul style="list-style-type: none"> <li>Turn off the power on the machine and turn it on after a while.  <a href="#">"Turning Off the Power"(P. 34)</a></li> </ul>
18f	OFFSET START		
18f	OFFSET END		
19f	LED CONNECT	<ul style="list-style-type: none"> <li>The UV- LED PCB could not be detected.</li> </ul>	<ul style="list-style-type: none"> <li>Turn off the power on the machine and turn it on after a while.  <a href="#">"Turning Off the Power"(P. 34)</a></li> </ul>



Error number	Message	Cause	Corrective action
1dc	Station4 PCB V24	<ul style="list-style-type: none"> <li>A problem was detected with the Station4 PCB power supply.</li> </ul>	<ul style="list-style-type: none"> <li>Turn off the power on the machine and turn it on after a while.  <a href="#">"Turning Off the Power"(P. 34)</a></li> </ul>
1dd	Station4 PCB V24-A		
1e6	PRAM Size Shortage	<ul style="list-style-type: none"> <li>Insufficient memory</li> </ul>	<ul style="list-style-type: none"> <li>Turn off the power on the machine and turn it on after a while.  <a href="#">"Turning Off the Power"(P. 34)</a></li> </ul>
201	Command Error	<ul style="list-style-type: none"> <li>Data other than print (RIP) data was received, or a problem was detected with the print (RIP) data received.</li> </ul>	<ol style="list-style-type: none"> <li>Clear the data and resend.</li> <li>Check the USB cable connection.  <a href="#">"Using a USB Cable"(P. 35)</a></li> <li>Use a compliant USB cable.  <a href="#">"USB Connection Precautions"(P. 35)</a></li> <li>Turn off the power on the machine and turn it on after a while.  <a href="#">"Turning Off the Power"(P. 34)</a></li> </ol>
202	Parameter Error	<ul style="list-style-type: none"> <li>A problem was detected with the print (RIP) data received.</li> </ul>	
206	Printing Mode	<ul style="list-style-type: none"> <li>Print (RIP) data was received with print parameters that do not allow printing.</li> </ul>	<ul style="list-style-type: none"> <li>Change the output parameters and profile using RIP software.</li> </ul>
304	USB INIT ERR	<ul style="list-style-type: none"> <li>A problem was detected with the USB cable connection.</li> </ul>	<ol style="list-style-type: none"> <li>Check the USB cable connection.  <a href="#">"Using a USB Cable"(P. 35)</a></li> <li>Use a compliant USB cable.  <a href="#">"USB Connection Precautions"(P. 35)</a></li> <li>Turn off the power on the machine and turn it on after a while.  <a href="#">"Turning Off the Power"(P. 34)</a></li> </ol>
305	USB TIME OUT		
307	MCFD File IF Error	<ul style="list-style-type: none"> <li>A problem was detected while accessing print parameter data.</li> </ul>	<ul style="list-style-type: none"> <li>Turn off the power on the machine and turn it on after a while.  <a href="#">"Turning Off the Power"(P. 34)</a></li> </ul>
401	Motor X	<ul style="list-style-type: none"> <li>The X motor was overloaded.</li> </ul>	<ol style="list-style-type: none"> <li>Check to confirm the media is loaded correctly.  <a href="#">"Loading the Media"(P. 59)</a></li> <li>Open the front cover and check for anything that may obstruct carriage movement.</li> <li>Turn off the power on the machine and turn it on after a while.  <a href="#">"Turning Off the Power"(P. 34)</a></li> </ol>
402	Motor Y	<ul style="list-style-type: none"> <li>The Y motor was overloaded.</li> </ul>	
403	X Current	<ul style="list-style-type: none"> <li>An overcurrent error was detected in the X motor.</li> </ul>	
404	Y Current	<ul style="list-style-type: none"> <li>An overcurrent error was detected in the Y motor.</li> </ul>	
406	Wiper Move Failure	<ul style="list-style-type: none"> <li>Wiper-origin could not be detected.</li> </ul>	<ol style="list-style-type: none"> <li>Clean the wiper and around the wiper.  <a href="#">"Wiper Cleaning"(P. 134)</a></li> <li>Turn off the power on the machine and turn it on after a while.  <a href="#">"Turning Off the Power"(P. 34)</a></li> </ol>
44e	UV Unit Fan Error	<ul style="list-style-type: none"> <li>A problem was detected with the UV-LED unit fan.</li> </ul>	<ul style="list-style-type: none"> <li>Turn off the power on the machine and turn it on after a while.  <a href="#">"Turning Off the Power"(P. 34)</a></li> </ul>
44f	Take-up Roll Sns Err	<ul style="list-style-type: none"> <li>A problem was detected with the take-up unit sensor spindle.</li> </ul>	<ol style="list-style-type: none"> <li>Check to confirm the [Machine Setup] &gt; [Feeding/Take-up] &gt; [Take-up Unit] setting is "ON".</li> <li>Check to confirm the media is loaded correctly.  <a href="#">"Loading the Roll Media"(P. 61)</a></li> </ol>

Error number	Message	Cause	Corrective action
			3. Check to confirm the take-up unit switch functions properly. (👉) "Take-up unit"(P. 59)
45a	P-HEAD TAKE OFF Err	• The carriage could not be disconnected.	• Turn off the power on the machine and turn it on after a while. (👉) "Turning Off the Power"(P. 34)
45b	P-HEAD Connct Err	• Unable to connect to carriage	
45c	C-HEAD TAKE OFF Err	• The cutter head could not be disconnected.	
45d	C-HEAD Connct Err	• Unable to connect to cutter head	
45e	Check PR/GR Position	• A problem was detected with the pinch roller positions.	• Place the pinch rollers above the grit rollers.
48a	Detect winding failure	• The take-up unit is unable to take up media.	• Check to confirm the media is loaded correctly. (👉) "Loading the Roll Media"(P. 61)
505	Media Jam	• The media jam sensor was triggered.	1. Remove the media in contact with the carriage and reload with fresh media. (👉) "Loading the Media"(P. 59) 2. Open the front cover and check for anything that may obstruct carriage movement.
509	HDC POSCNT	• A problem was detected with position control.	• Turn off the power on the machine and turn it on after a while. (👉) "Turning Off the Power"(P. 34)
50a	Y Org Detect Error	• A problem was detected with Y origin detection (initialization).	
50c	Check Media With Sensor	• A problem was detected with media width detection.	1. Check the media loading position. (👉) "Loading the Media"(P. 59) 2. Clean the media width sensor. (👉) "Media Sensor Cleaning"(P. 141)
50f	L-SCALE BLACK	• A problem was detected with the linear scale.	• Turn off the power on the machine and turn it on after a while. (👉) "Turning Off the Power"(P. 34)
516	Media Set Position R	• The media was loaded outside the range of valid positions.	1. Check the media loading position. (👉) "Loading the Media"(P. 59) 2. Clean the media width sensor. (👉) "Media Sensor Cleaning"(P. 141)
519	NEGATIVE P.SENSOR	• Negative pressure sensor automatic recognition failed.	• Turn off the power on the machine and turn it on after a while. (👉) "Turning Off the Power"(P. 34)
521	CHECK JOINT SENSOR	• A failure occurred while connecting the cutter head and the connecting unit.	
522	CUT HOME POSITION	• The cutter head could not be moved due to a connection failure between the cutter head and the connecting unit.	



Error number	Message	Cause	Corrective action
523	Check PR Sensor	<ul style="list-style-type: none"> <li>The pinch roller position detection failed.</li> </ul>	
525	Wrong Ionizer	<ul style="list-style-type: none"> <li>The ionizer internal circuit is defective, or an abnormal discharge occurred.</li> </ul>	<ul style="list-style-type: none"> <li>Turn off the power on the machine and turn it on after a while.  <a href="#">"Turning Off the Power"(P. 34)</a></li> </ul>
526	Ionizer Ion Level	<ul style="list-style-type: none"> <li>The amount of generated ions was reduced by fouling and abrasion of the electrode needle.</li> </ul>	<ul style="list-style-type: none"> <li>Refer to the instruction manual for the ionizer and clean the electrodes.</li> </ul>
527	Ionizer Condition	<ul style="list-style-type: none"> <li>Ambient conditions may cause ions to be absorbed by metals in the vicinity and affect discharge capability.</li> </ul>	<ul style="list-style-type: none"> <li>Remove any conductors or discharge devices close to the ionizer.</li> </ul>
528	Pump Motor Sensor	<ul style="list-style-type: none"> <li>A problem was detected with the pump motor.</li> </ul>	<ul style="list-style-type: none"> <li>Turn off the power on the machine and turn it on after a while.  <a href="#">"Turning Off the Power"(P. 34)</a></li> </ul>
549	LEnc. Count DIO	<ul style="list-style-type: none"> <li>A problem was detected with the linear scale wiring to the DIO PCB.</li> </ul>	<ul style="list-style-type: none"> <li>Turn off the power on the machine and turn it on after a while.  <a href="#">"Turning Off the Power"(P. 34)</a></li> </ul>
551	HDC DIO LENC count	<ul style="list-style-type: none"> <li>A problem was detected with the HDC and DIO board encoder values.</li> </ul>	<ul style="list-style-type: none"> <li>Turn off the power on the machine and turn it on after a while.  <a href="#">"Turning Off the Power"(P. 34)</a></li> </ul>
602	Ink Bottle End	<ul style="list-style-type: none"> <li>The ink has run out.</li> </ul>	<ul style="list-style-type: none"> <li>Replace with new ink.  <a href="#">"When Ink End is Displayed"(P. 41)</a></li> </ul>
607	Replace Cap Absorber	<ul style="list-style-type: none"> <li>The capping count exceeded the preset value.</li> </ul>	<ul style="list-style-type: none"> <li>Replace and clean the cap absorber, then reset the count.  <a href="#">"Cap Absorber Replacement"(P. 148)</a></li> </ul>
608	Wrong Ink IC	<ul style="list-style-type: none"> <li>An error occurred with the information on the ink IC chip.</li> </ul>	<ol style="list-style-type: none"> <li>Check to confirm the ink IC chip was inserted correctly. Inserting the Ink IC Chip</li> <li>Turn off the power on the machine and turn it on after a while.  <a href="#">"Turning Off the Power"(P. 34)</a></li> <li>Replace with new ink.  <a href="#">"Replacing Ink"(P. 42)</a></li> </ol>
61a	InkOverflow	<ul style="list-style-type: none"> <li>The sub tank float sensor detected the limit.</li> </ul>	<ul style="list-style-type: none"> <li>Execute [Maintenance] &gt; [Overflow].</li> </ul>
61b	Ink supply	<ul style="list-style-type: none"> <li>A failure occurred while supplying ink to the sub tank.</li> </ul>	<ul style="list-style-type: none"> <li>Turn off the power on the machine and turn it on after a while.  <a href="#">"Turning Off the Power"(P. 34)</a></li> </ul>
61d	NEGATIVE P. NotEnough	<ul style="list-style-type: none"> <li>Negative pressure cannot be properly maintained. (On the positive side)</li> </ul>	
61e	NEGATIVE P. OVER	<ul style="list-style-type: none"> <li>Negative pressure cannot be properly maintained. (On the negative side)</li> </ul>	

Error number	Message	Cause	Corrective action
620	POSITIVE P. NotEnough	<ul style="list-style-type: none"> <li>Positive pressure cannot be properly maintained. (On the negative side)</li> </ul>	
621	POSITIVE P. OVER	<ul style="list-style-type: none"> <li>Positive pressure cannot be properly maintained. (On the positive side)</li> </ul>	
627	INK BOTTLE SET	<ul style="list-style-type: none"> <li>The ink IC chip could not be read for a certain period of time.</li> </ul>	<ol style="list-style-type: none"> <li>Check to confirm the ink IC chip was inserted correctly.</li> <li>Turn off the power on the machine and turn it on after a while.  <a href="#">"Turning Off the Power"(P. 34)</a></li> </ol>
64C	NCU Error	<ul style="list-style-type: none"> <li>The function is disabled due to an error.</li> </ul>	<ul style="list-style-type: none"> <li>Turn off the power on the machine and turn it on after a while.  <a href="#">"Turning Off the Power"(P. 34)</a></li> </ul>
650	NCU Connect	<ul style="list-style-type: none"> <li>A problem was detected with the NCU connection.</li> </ul>	
651	Replace NCU	<ul style="list-style-type: none"> <li>A problem was detected with the nozzle clogging assessment.</li> </ul>	<ul style="list-style-type: none"> <li>The NCU must be replaced. Contact your local distributor, our sales office, or service center.</li> </ul>
652	NCU NzK Chk (Hw)	<ul style="list-style-type: none"> <li>A problem was detected with the nozzle clogging assessment.</li> </ul>	<ul style="list-style-type: none"> <li>Clean the NCU.  <a href="#">"NCU Cleaning"(P. 137)</a></li> </ul>
653	NCU NzK Chk (Mark)		
654	NCU Center Pos	<ul style="list-style-type: none"> <li>Printing position adjustment failed.</li> </ul>	
655	NCU Flush Pos		
656	NCU SN Adjst	<ul style="list-style-type: none"> <li>Sensor sensitivity adjustment failed.</li> </ul>	
657	Replace NCU Ink Pad	<ul style="list-style-type: none"> <li>The NCU ink absorber is full.</li> </ul>	<ul style="list-style-type: none"> <li>The NCU ink absorber must be replaced. Contact your local distributor, our sales office, or service center.</li> </ul>
658	NCU Sensor Lv Low	<ul style="list-style-type: none"> <li>The sensor's sensitivity is impaired.</li> </ul>	<ul style="list-style-type: none"> <li>Clean the NCU.  <a href="#">"NCU Cleaning"(P. 137)</a></li> <li>Replace the NCU if the error does not clear. Contact your local distributor, our sales office, or service center.</li> </ul>
65b	NCU Sens Adj Err H	<ul style="list-style-type: none"> <li>Sensor sensitivity adjustment failed.</li> </ul>	
65c	NCU Sens Adj Err L		
707	!HD Heater Brk	<ul style="list-style-type: none"> <li>Head heater disconnected</li> </ul>	<ul style="list-style-type: none"> <li>Turn off the power on the machine and turn it on after a while.  <a href="#">"Turning Off the Power"(P. 34)</a></li> </ul>
715	InkHeater Thr	<ul style="list-style-type: none"> <li>A problem was detected with the ink heater thermistor.</li> </ul>	<ul style="list-style-type: none"> <li>Turn off the power on the machine and turn it on after a while.  <a href="#">"Turning Off the Power"(P. 34)</a></li> </ul>
716	InkHeater Tmp		
717	InkHeater Brk		
71a	UV-DRV Fuse	<ul style="list-style-type: none"> <li>A UV-DRV PCB fuse blew.</li> </ul>	
901	Operation Error	<ul style="list-style-type: none"> <li>The function is disabled due to an error.</li> </ul>	<ul style="list-style-type: none"> <li>Check the error details.</li> </ul>
902	Data Remain	<ul style="list-style-type: none"> <li>Print (RIP) data was received.</li> </ul>	<ul style="list-style-type: none"> <li>Switch to REMOTE mode and start printing or clear the data and abort printing.</li> </ul>

Error number	Message	Cause	Corrective action
90d	No Head Select	<ul style="list-style-type: none"> <li>A problem was detected with the print head.</li> </ul>	<ul style="list-style-type: none"> <li>Turn off the power on the machine and turn it on after a while.  <a href="#">"Turning Off the Power"(P. 34)</a></li> </ul>
90f	Print Area Short	<ul style="list-style-type: none"> <li>The media is too small for the print.</li> </ul>	<ul style="list-style-type: none"> <li>Replace with wider or longer media.</li> <li>If the printable area is reduced due to a shift in the origin, move the origin to increase the size of the printable area.</li> </ul>
b0a	CTC PCB Vpow	<ul style="list-style-type: none"> <li>A problem was detected with the CTC PCB power supply voltage.</li> </ul>	<ul style="list-style-type: none"> <li>Turn off the power on the machine and turn it on after a while.  <a href="#">"Turning Off the Power"(P. 34)</a></li> </ul>
b0b	CTC PCB V24		
b0c	CTC PCB V5R0		
b0d	CTC PCB V3R3		
b0e	CTC PCB V2R5		
b0f	DIO PCB Uvpow	<ul style="list-style-type: none"> <li>A problem was detected with the UV-DRV PCB power supply voltage.</li> </ul>	<ul style="list-style-type: none"> <li>Turn off the power on the machine and turn it on after a while.  <a href="#">"Turning Off the Power"(P. 34)</a></li> </ul>
b19	Station4 PCB V36	<ul style="list-style-type: none"> <li>A problem was detected with the station IV PCB power supply.</li> </ul>	<ul style="list-style-type: none"> <li>Turn off the power on the machine and turn it on after a while.  <a href="#">"Turning Off the Power"(P. 34)</a></li> </ul>
C10	Commands	<ul style="list-style-type: none"> <li>Received a code other than a COMMAND code.</li> </ul>	<ol style="list-style-type: none"> <li>Clear the data and resend.</li> <li>Turn off the power on the machine and turn it on after a while.  <a href="#">"Turning Off the Power"(P. 34)</a></li> <li>Check the USB cable connection.  <a href="#">"Using a USB Cable"(P. 35)</a></li> <li>Use a compliant USB cable.  <a href="#">"USB Connection Precautions"(P. 35)</a></li> </ol>
C11	Parameter	<ul style="list-style-type: none"> <li>Received parameter outside numerical value range</li> </ul>	
C12	Device	<ul style="list-style-type: none"> <li>Received an invalid device control command.</li> </ul>	
C31	No Data	<ul style="list-style-type: none"> <li>"COPY" was executed, but no data is saved to the receive buffer.</li> </ul>	<ul style="list-style-type: none"> <li>Cut the same data once more.</li> </ul>
C32	DataTooBig	<ul style="list-style-type: none"> <li>The received data is too big for multiple sheet cutting.</li> </ul>	<ul style="list-style-type: none"> <li>Change the data size.</li> </ul>
C33	Sheet Size	<ul style="list-style-type: none"> <li>The sheet is too short in the feed direction.</li> </ul>	<ul style="list-style-type: none"> <li>Use a longer sheet.</li> </ul>
C36	Mark Detect	<ul style="list-style-type: none"> <li>Unable to detect register marks</li> </ul>	<ol style="list-style-type: none"> <li>Check to confirm the register marks are placed properly.  <a href="#">"Register Marks"(P. 100)</a></li> <li>Load the uncurled media.</li> <li>Check the mark detection start position.</li> <li>Check to confirm the register marks are black and printed on a white background.</li> <li>Check to confirm the area between the register marks is clean and free of print.</li> <li>Check to confirm there are no errors in the mark detection settings.</li> <li>If the area around the register marks is filled in, set [Mark Detect] &gt; [Mark FillUp] setting to "ON".</li> </ol>

Error number	Message	Cause	Corrective action
C37	Mark Org	<ul style="list-style-type: none"> <li>The mark detection result shows that the register marks were detected outside the plotting range.</li> </ul>	<ul style="list-style-type: none"> <li>Change the layout by referring to the following:  <a href="#">"Reading Range of Register Marks"(P. 103)</a></li> </ul>
C60	PenEncoder	<ul style="list-style-type: none"> <li>Unable to detect pen height</li> </ul>	<ul style="list-style-type: none"> <li>Turn off the power on the machine and turn it on after a while.  <a href="#">"Turning Off the Power"(P. 34)</a></li> </ul>
C61	Pen Stroke	<ul style="list-style-type: none"> <li>The pen height is incorrect.</li> </ul>	<ol style="list-style-type: none"> <li>Make sure the pen line rubber is not worn or deformed and remains intact.</li> <li>Check to confirm nothing adheres to the pen line rubber.</li> <li>After installing the pen in a commercially available pen holder, check to confirm the installed position is correct.</li> </ol>

## SYSTEM HALT

Error number	Message	Corrective action
406	WIPER ORG	<ol style="list-style-type: none"> <li>Clean the wiper and around the wiper.  <a href="#">"Wiper Cleaning"(P. 134)</a></li> <li>Turn off the power on the machine and turn it on after a while.  <a href="#">"Turning Off the Power"(P. 34)</a></li> </ol>
1c3	PCB SLDR2H	<ol style="list-style-type: none"> <li>Turn off the power on the machine and turn it on after a while.  <a href="#">"Turning Off the Power"(P. 34)</a></li> </ol>



- If any other SYSTEM HALT number is displayed, Turn off the power on the machine and turn it on after a while.  ["Turning Off the Power"\(P. 34\)](#)





# Chapter 8 Appendix



**This chapter**

This chapter explains the specifications of this machine.

Specifications .....	186	LICENSE Library .....	190
Specifications (Cutting) .....	189		

# 8.1 Specifications

Item		UCJV300				UCJV150	
		160	130	107	75	160	
Print head	Type	On-demand piezo head					
	Specifications	Two inline heads with 4 rows				One head with 4 rows	
	Resolution	Y: 300 dpi, 600 dpi, 1,200 dpi X: 600 dpi, 900 dpi, 1,200 dpi					
Ink set	4-color	C, M, Y, K				C, M, Y, K	
	4-color, W	C, M, Y, K, W				-	
	4-color, W, CL	C, M, Y, K, W, CL				-	
	6-color, W	C, M, Y, K, Lc, Lm, W				-	
Media	Type	Label paper (paper base), PVC sheet (not more than 0.25 mm in thickness, including laminating layer), fluorescent sheet, reflective sheet (excluding high-luminosity reflective sheet)					
	Maximum printing/cut width <sup>*1</sup>	1,610 mm	1,361 mm	1,090 mm	800 mm	1,610 mm	
	Common for roll/leaf	Maximum width	1,620 mm	1,371 mm	1,100 mm	810 mm	1,620 mm
		Minimum width	210 mm				
		Thickness	Max. 1.0 mm				
	Roll	Roll external diameter <sup>*2</sup>	Max. 250 mm (paper media), max. 210 mm (other media)				
		Roll weight <sup>*2, *3</sup>	Max. 40 kg				
		Paper core internal diameter <sup>*4</sup>	2 inches or 3 inches				
		Printing face	Exterior/interior				
		Roll end	Taped or loosely affixed to paper core				
Print margins	Left/right	15.0 mm (default), minimum: Left/right 5 mm					
	Top end	120 mm					
	Bottom end	150 mm					
Distance accuracy <sup>*5</sup>	Absolute accuracy	±0.3 mm or ±0.3 % of specified distance, whichever is greater					
	Duplicability	±0.2 mm or ±0.1% of specified distance, whichever is greater					
Perpendicularity	±0.5 mm/1,000 mm						
Media skew	Not more than 5 mm/10 m						
Printing gap	Manual, three settings (2.0, 2.5, 3.0 mm)						
Media cutting	Cutting precision (steps): Not more than 0.5 mm						

Item		UCJV300				UCJV150
		160	130	107	75	160
Origin alignment		LED pointer				
Ink supply		Ink bottle				
Maintenance liquid feed		N/A				
Waste ink tank		Bottle type (2,000 ml)				
Take-up units		Selectable inside/outside winding				
Media heater		N/A				
NCU (Nozzle clogging detection)		Provided				
UV unit		Air-cooled LED UV emitters x2				
Image buffer		SD-RAM: 2 GB				
Interface	Data transfer function	USB 2.0 Hi-speed, Ethernet 1000BASE-T				
	Email function	Ethernet 10BASE-T/100BASE-TX/1000BASE-T				
Commands		MRL-V				
Languages		English, Japanese, Chinese, Turkish, Portuguese				
Noise levels	During standby	Not more than 55dB (FAST-A, 1 m on all sides)				
	Continuous operation	Max. 65 dB				
	Non-continuous operation	Max. 70 dB				
Compliance with standards		VCCI Class A, FCC Class A, IEC 62368-1 ETL compliance, CE marking (EMC Directive, Low Voltage Directive, Machinery Directive), CB certified, RoHS, REACH, EnergyStar, RCM marking				
Power supply specifications <sup>*6</sup>		Single-phase 100 to 120 V AC $\pm 10\%$ /12 A, single-phase 200 to 240 V AC $\pm 10\%$ /8 A, 50/60 Hz $\pm 1$ Hz				
Power consumption	Standard	-				
	Maximum	1,440 W (100 to 120 V AC), 1,920 W (200 to 240 V AC)				
	Minimum	-				
Installation environment <sup>*7</sup>	Permissible ambient temperature	20 to 30 °C				
	Relative humidity	35 to 65 %RH (no condensation)				
	Temperature range in which accuracy is guaranteed	20 to 25°C				
	Temperature gradient	Not more than $\pm 10$ °C/h				
	Dust	0.15 mg/m <sup>3</sup> (typical office)				
	Maximum operating altitude	2,000 m (6561.7 ft)				
External dimensions <sup>*8</sup>	Width	2,900 mm (- mm)	2,650 mm (- mm)	2,380 mm (- mm)	2,090 mm (- mm)	2,900 mm (- mm)
	Depth	776 mm (- mm)				
	Height <sup>*Excluding ink bottle</sup>	1,475 mm (xxxx mm)				

Item	UCJV300				UCJV150
	160	130	107	75	160
Weight <sup>*8</sup>	188 kg (- kg)	177 kg (- kg)	161kg (- kg)	144kg (- kg)	183kg (- kg)

- \*1. Setup menu margins set to the minimum (5 mm) on either side
- \*2. External diameter and weight after winding media
- \*3. Free of sagging due to weight
- \*4. 3 inch only for high-speed printing
- \*5. Excluding media size variation and fluctuations at initial loading
- \*6. Excluding options
- \*7. Ink printing consistency will decrease in conditions outside this range.
- \*8. The figures in parentheses indicate package dimensions.

## 8.2 Specifications (Cutting)

Item	Details
Maximum speed <sup>*1</sup>	30cm/s (42cm/s at 45°)
Maximum acceleration	0.5 G
Cut pressure	10 to 450 g
Cutter response count	10 times/second
Usable tools	Eccentric cutter, ballpoint pen (commercially sold) <sup>*2</sup>
Usable media	Label paper (paper base), PVC sheet <sup>*3</sup> (not more than 0.25 mm thick, including lamination), fluorescent sheet <sup>*4</sup> , reflective sheet <sup>*4</sup> (excluding high-luminosity reflective sheet)
Repetition accuracy	±0.2 mm or less (excluding expansion and contraction due to temperature)
Receive buffer memory	32 MB
Command	MGL-II c2
Program steps	25 μm/step

\*1. Depending on media size, the maximum speed may be limited. It is not possible to operate at both maximum speed and maximum acceleration.

\*2. Use one free of protrusions and tapers on the clamped part. Depending on the ballpoint pen, optimal image quality may not be possible.

\*3. When using our specified sheet

\*4. When using fluorescent sheet blade (SPB-0007) or reflective sheet blade (SPB-0006)

## 8.3 LICENSE Library

Mimaki printer Firmware

Copyright ©2020 MIMAKI ENGINEERING CO.,LTD. All rights reserved.

This product contain open source software listed in the tables below.

Component	License
StarterWare for ARM® based TI Sitara Processors	BSD-TI

The following license terms and conditions shall apply to the open source software listed in the table above:

BSD-TI

Copyright (C) 2010 Texas Instruments Incorporated - <http://www.ti.com/>

Redistribution and use in source and binary forms, with or without modification, are permitted provided that the following conditions are met:

1. Redistributions of source code must retain the above copyright notice, this list of conditions and the following disclaimer.
2. Redistributions in binary form must reproduce the above copyright notice, this list of conditions and the following disclaimer in the documentation and/or other materials provided with the distribution.
3. Neither the name of Texas Instruments Incorporated nor the names of its contributors may be used to endorse or promote products derived from this software without specific prior written permission.

THIS SOFTWARE IS PROVIDED BY THE COPYRIGHT HOLDERS AND CONTRIBUTORS "AS IS" AND ANY EXPRESS OR IMPLIED WARRANTIES, INCLUDING, BUT NOT LIMITED TO, THE IMPLIED WARRANTIES OF MERCHANTABILITY AND FITNESS FOR A PARTICULAR PURPOSE ARE DISCLAIMED. IN NO EVENT SHALL THE COPYRIGHT OWNER OR CONTRIBUTORS BE LIABLE FOR ANY DIRECT, INDIRECT, INCIDENTAL, SPECIAL, EXEMPLARY, OR CONSEQUENTIAL DAMAGES (INCLUDING, BUT NOT LIMITED TO, PROCUREMENT OF SUBSTITUTE GOODS OR SERVICES; LOSS OF USE, DATA, OR PROFITS; OR BUSINESS INTERRUPTION) HOWEVER CAUSED AND ON ANY THEORY OF LIABILITY, WHETHER IN CONTRACT, STRICT LIABILITY, OR TORT (INCLUDING NEGLIGENCE OR OTHERWISE) ARISING IN ANY WAY OUT OF THE USE OF THIS SOFTWARE, EVEN IF ADVISED OF THE POSSIBILITY OF SUCH DAMAGE.

# Index

A	
AC inlet.....	25
Adj-prs Offset .....	127, 171
Air PG.....	116
Auto Cleaning .....	111
Auto Maint. ....	115
Auto Media Cut.....	127
Auto Nozzle Recovery .....	123
Auto Power-off.....	118
B	
Bottle cap .....	42, 43, 45
C	
Cancel .....	29
Cap .....	133, 136
Cap absorber.....	148
Capping station .....	24, 26
Carriage.....	24, 26, 133, 138
Carriage movement.....	29
Carriage Out.....	115
Clamp lever .....	24, 25
Cleaning Check .....	111
Color profile .....	38
Copy .....	126, 128, 182
Corner Cut.....	127, 128
Curve Mode.....	127
Custody Wash .....	115, 144
Cut Mode.....	126
Cutter unit.....	24
Cutting Menu .....	125
Cutting slot .....	27
D	
Detect Area .....	125
Detect End Key Start.....	125
DISCLAIMERS .....	6
Display.....	29, 30
Display language.....	118

Drop.PosCorrect.....	31, 52, 74, 110
Drying Time .....	111
Dummy cut .....	126

---

## E

---

Ejection failures .....	162
[END/POWER] key.....	28, 29, 34
[ENTER] key.....	29
Error.....	29, 174
Error History .....	124
Event Mail.....	119, 120
Exhaust fan BOX.....	133, 152
Exhaust fan filter.....	133, 151

---

## F

---

FCC .....	7
Feed Comp.....	31, 51, 72, 110
Feed Speed .....	111
Feed unit .....	25
Fill Up Ink .....	116
FineCut.....	104
[FUNCTION] key .....	29, 31

---

## G

---

Grit roller.....	26, 54
Grit rollers .....	24

---

## H

---

Half Cut .....	92, 160
Head Cleaning.....	29, 71
Head height .....	53
Head Maintenance .....	115
Height adjustment lever.....	53

---

## I

---

ID Cut Guide.....	103, 107
ID Cut .....	103, 107
Information menu .....	124
Ink discharge channel .....	133, 140
INK END .....	41
Ink Error.....	30
Ink IC chip .....	47



Ink IC chip slot.....	24
INK NEAR END.....	41
Ink REPL.Report .....	124
Ink status .....	30
Ink status indicator lamp.....	27
Ink status lamp .....	24
Ink supply unit .....	24, 27, 47
Ink wipe filter .....	24, 25
Inlet.....	33
Installation guide .....	38, 39, 40
Installation Space .....	17
Interference .....	6
interlock .....	19
Interval Wiping.....	111
Ionizer.....	112
<hr/> <b>J</b> <hr/>	
Jam sensor .....	133, 142
[JOG] key .....	29
Judgment Condition .....	123
<hr/> <b>K</b> <hr/>	
Key Buzzer .....	118
<hr/> <b>L</b> <hr/>	
LAN cable .....	35
LAN port .....	25
LANGUAGE .....	118
Leaf media.....	65
Light-blocking cover .....	42
List.....	124
Local guidance .....	32
LOCAL mode.....	29, 30
Logical Seek.....	110
LT mode .....	112, 113
<hr/> <b>M</b> <hr/>	
Machine setup menu .....	118
Main power switch.....	25, 28, 33
Maintenance cover .....	24
Maintenance menu .....	115
MAPS .....	112

Margin .....	103, 111
Mark Detect .....	100, 103, 105, 106, 125, 182, 183
Mark FillUp .....	125
Marks Sensor .....	127, 168, 169, 170
Media.....	59
Media Detect .....	118
Media feed.....	29
Media hanger .....	61
Media holder.....	133, 142
Media Remain .....	118
Media Sensor .....	25, 28, 133, 141
MENU mode.....	30
Mimaki driver .....	38
MIST FILTER.....	133, 139, 149
Multilayer printing .....	68

---



---

N

---



---

NCU.....	26, 133, 137
Network .....	119
NOT-READY mode .....	30
Nozzle check menu .....	123
Nozzle Recovery .....	115
Nozzle Wash .....	115, 163, 164

---



---

O

---



---

Offset.....	92
Operating panel.....	24, 29
Over Cut .....	127, 128
OVER PRINT.....	110
Overflow .....	116

---



---

P

---



---

Pen line .....	160
Pinch roller .....	24, 26, 51, 54, 68, 82, 152
Pinch roller guide.....	54
Platen .....	24, 27, 133, 144
Power cable.....	33
Power outlet .....	33
Power plug .....	33
Print Area .....	124
Print Length .....	124
Print origin .....	77

Printing Check .....	123
Pump tube cleaning.....	115, 141

---



---

## R

---

RasterLink .....	38, 39, 40, 75, 76, 103, 104, 111, 169, 171
Receive buffer .....	78, 95, 126, 128, 168, 182
Reference guide .....	76, 171
Register mark .....	98, 100, 101, 102, 104, 125
Remaining ink.....	30
REMOTE mode .....	29, 30
Replace Cap Absorber .....	148
Replace Wasteinktank.....	116, 157
Replace Wiper.....	115, 147
Roll holder .....	61
Roll media .....	61

---



---

## S

---

Sample Cut.....	127, 168, 171
Scale Adjust .....	127, 169
[SEL] key .....	29
Sensor sensitivity .....	125, 174, 175, 181
Setup Menu .....	110
Setup Sub Menu.....	126
Sheet Type .....	127
Smoothing Level.....	112
Space Feed Mode .....	119
Station Maint. ....	115
Status lamp .....	29
Switching hub .....	36
Symbols.....	8
SYSTEM HALT .....	29

---



---

## T

---

Take-up SW .....	118
Take-up Unit.....	24, 59, 118
Temporary .....	112
Test printing.....	29, 69
Time Set .....	118
Tool Change .....	85, 90, 126, 156
Torque limiter .....	60

---



---

## U

---

UNIT / LENGTH.....	118
UNIT / TEMP .....	118
Up Speed .....	126
Usage .....	124
USB interface cable.....	35
USB port.....	25
Use Time .....	124
UV AdjVal .....	112
UV Lamp .....	124
UV mode .....	111
UV-LED lamp .....	133, 139

---

---

V

---

---

Vacuum Fan .....	25, 111, 127
Version .....	124
View Feed .....	118

---

---

W

---

---

Warning Label .....	20
Waste ink tank.....	24, 124, 133, 156
White ink.....	69
Wiper.....	133, 134, 147
Wiping .....	124

## **Operation manual**

---

---

February, 2023

**MIMAKI ENGINEERING CO.,LTD.**

2182-3 Shigeno-otsu, Tomi-shi, Nagano 389-0512 JAPAN

---

---

D203176-29-01022023

