

USER'S MANUAL

TMCP-VF

1.To turn ON the power	36
2.Preparation before embroidering.....	36
3.To input design to machine memory.....	40
4.To decide embroidery design (Data Setting)	46
5.To decide embroidery mode	48
6.Items to check	50
7.To move frame to start position	52
8.To start embroidering.....	55

A video can be played on PDF.

When the following title is pressed, it will jump to a video page.

 Thread passing



Foreword

This user's manual describes about the correct using method and instructions for use of this product. Please use this machine after understanding the contents of the manual.

This manual may contain discrepancies in detailed specifications as compared with the actual production model. If you have any questions about this manual, consult your TAJIMA distributor.

We believe that "BASICS TAJIMA EMBROIDERY MACHINES" and "MACHINE SETUP INSTRUCTIONS" are useful to deepen your knowledge about this product. Please also read those booklets.

Regarding how to handle the products related, refer to the user s manual exclusive for them included in the manual CD.

TISM Co.,Ltd.

Safety precautions

To prevent any harm or damage to the person who use this product or other person, we describe items that must be surely followed as below.



Indicates that there is a lot of danger of death or serious injuries [*1] if handled by mistake.



Indicates that there is a likelihood of death or serious injuries [*1] if handled by mistake.





Indicates a potentially hazardous situation which may result in minor or moderate injury [*2] or property damage if handled by mistake.

*1: A condition caused by electric shock, injury, fracture of a bone, etc., that leads to aftereffects, or an injury that necessitates hospitalization or visits to a hospital over a long period.

*2: An injury that does not necessitate hospitalization or visit to a hospital over a long period.

 : Prohibited items



 : Items that may cause electric shock if not observed

 : Items that must be followed carefully to ensure safe operation

1. Functional Limit Level (Operation Level)

Various types of machine operations are controlled by each functional limit level. This functional limit level will limit some operation and it has the purpose to protect designs from taking out unnecessarily or prevent incorrect parameter setting.

Functional Limit Level "1" is set at shipment. To change Functional Limit Level, input of the password is necessary. For details, consult the distributor.

Functional Limit Level	Limit contents
	<p>ALL Yes^e (Cancellation of Functional Limit Level)(→p.142)</p> <ul style="list-style-type: none"> All parameters will be displayed. All settings will be changable.
 Setting at shipment	<ul style="list-style-type: none"> Only items of parameter P1 to P6 will be displayed. However, "2 Functional Limit Level" of Page P8 will be displayed. Writing the design data to the USB memory is prohibited.(→p.79) Design data edit in the machine memory is prohibited.(→p.85 to p.88) Insertion of stitch, deletion of stitch, modification of stitch Detailed setting (shown below) at step unit setting will be hidden.(→p.115) Satin Stitch (area), Satin Stitch (density), Satin Stitch (Expansion)
 (→p.138)	<ul style="list-style-type: none"> All parameters will be hidden. However, "2 Functional Limit Level" of Page P8 will be displayed. Writing the design data to the USB memory is prohibited.(→p.79) Design data edit in the machine memory is prohibited.(→p.85 to p.88) Insertion of stitch, deletion of stitch, modification of stitch Detailed setting (shown below) at step unit setting will be hidden.(→p.115) Satin Stitch (area), Satin Stitch (density), Satin Stitch (Expansion)

Chapter 1 Items that must be followed carefully

1.	To use this machine safely	2
1-1.	Warning	2
1-2.	Caution	3
2.	Warning labels	5
3.	Checking before starting operation	7

Chapter 2 Name and way to use of each part

1.	Name of each part	10
2.	How to use each part	11
2-1.	Power switch	11
2-2.	Emergency stop switch	12
2-3.	Bar switch	13
2-4.	Table offset switch	16
2-5.	Clutch lever	17
2-6.	Operation panel	18
2-7.	USB port	18
2-8.	LAN port	19
3.	Tension base	20
3-1.	Right and left LED	20
3-2.	Right LED	20
3-3.	Left LED	21
3-4.	Direct command switch	22

Chapter 3 Screen

1.	Basic screen	26
1-1.	Main screen (Screen 1010)	26
1-2.	Design selection screen (Screen 2000)	28
1-3.	USB memory screen (Screen 3100)	29
1-4.	Data set screen	31
1-5.	Needle bar selection screen (Screen 2010)	32
2.	Input operation	34
2-1.	To input value	34
2-2.	To input character	34

Chapter 4 How to operate

1.	To turn ON the power	36
2.	Preparation before embroidering	36
2-1.	To set fabric	36
2-2.	Thread passing	37
3.	To input design to machine memory.....	40
3-1.	To input design in USB memory to machine memory	40
3-2.	To input design in personal computer to machine memory	41
3-3.	To input design in personal computer to machine memory (Using a bar code reader)	43
4.	To decide embroidery design (Data Setting)	46
5.	To decide embroidery mode	48
5-1.	To perform color change and start operation automatically.....	48
5-2.	To decide needle bar order.....	48
6.	Items to check.....	50
6-1.	To check size of design and setting contents	50
6-2.	To check the heads to be used.....	51
6-3.	To decide maximum speed.....	51
7.	To move frame to start position	52
7-1.	To move frame.....	52
7-2.	To check if design fits in embroidery space (Tracing)	53
8.	To start embroidering.....	55
8-1.	Handling of thread breakage	55
8-2.	Completion of embroidery.....	58

Chapter 5 Manual operation

1.	To return frame, to advance frame	60
1-1.	To switch "To return frame" , "To advance frame".....	60
1-2.	To perform "To return frame", "To advance frame"	61
1-3.	To perform "To return frame", "To advance frame"	62
2.	Thread trimming, color change	63
2-1.	To trim thread	63
2-2.	To change color	64
3.	Frame Travel	65
3-1.	To move frame to registered position (Frame travel to optional position).....	65
3-2.	To return the moved frame to the previous position (Manual Offset)	65
3-3.	To return frame to the start position (Start position return).....	66
3-4.	To move frame to the registered position (Offset return).....	66

3-5.	To move frame by inputing value (Input value for Frame Travel).....	67
3-6.	To make machine memorize frame origin (Absolute origin search)	69
3-7.	Resume operation when power is shut off (Power resume).....	70
4.	Raising and lowering of needle bar	71
4-1.	To lower needle bar.....	71
4-2.	To raise needle bar	71
4-3.	To lower needle bar to lower dead point	72
5.	Various functions.....	73
5-1.	To turn ON/OFF the LED lamp.....	73
5-2.	Machine log data Download	73
5-3.	To open the movable knife (ATH clean-up function)	74

Chapter 6 Delete, save and edit of design

1.	To delete design.....	76
1-1.	To delete design in machine memory by one design unit	76
1-2.	To delete plural designs in machine memory	77
1-3.	To delete design in USB memory.....	78
2.	To save design, to change design name.....	79
2-1.	To write design into a USB memory (Input of a password is necessary)	79
2-2.	To change saving place of design	81
2-3.	To change design name	82
3.	To edit design.....	83
3-1.	To search stitch by specifying stitch No.	83
3-2.	To search stitch by specifying function code	84
3-3.	To insert a stitch (Input of the password is necessary)	85
3-4.	To delete a stitch (Input of the password is necessary)	87
3-5.	To modify a stitch (Input of the password is necessary).....	88
3-6.	To delete small stitch.....	89
4.	To copy, to divide and to combine design	91
4-1.	To copy design	91
4-2.	To divide design	92
4-3.	To combine design	93

Chapter 7 Convenient functions

1.	To move the frame to the position registered	98
1-1.	To move the frame automatically at the start and the end of embroidery (Automatic Offset).....	98
1-2.	To delete frame position registered (Automatic offset deletion)	100
1-3.	To move frame at a desired position during embroidery (Automatic free setting offset) ...	101
1-4.	To move frame at color change position during embroidery (Auto color change offset) ...	103
2.	To change size of design/To change direction of design (Data conversion)	104
2-1.	To scale up/down.....	104
2-2.	To rotate design.....	105
2-3.	To reverse a design	107
3.	To embroider repeatedly (Repeat).....	108
3-1.	To repeat design by specifying vertical or horizontal and number of times	108
3-2.	To arrange design automatically.....	110
3-3.	To reverse design alternately	111
4.	Advanced setting of the needle bar step	113
4-1.	To delete the needle bar selection setting	113
4-2.	To insert a new setting in the needle bar selection setting	114
4-3.	To embroider design by changing condition only for the desired step (Setting by step unit).....	114
4-4.	To replace specified needle bar No. with another needle bar No. in a batch (Needle bar conversion)	118
5.	To select working head to embroider (Head selection)	119
5-1.	To set pattern No. in every needle bar step.....	119
5-2.	To set working head for each pattern	120
5-3.	To activate the odd-numbered head or the even-numbered head only.....	122
6.	Needle bar color	123
6-1.	To change the needle bar color	123
7.	Head group	124
8.	Marking	125

Chapter 8 Optional device

1.	Sequin Device	130
1-1.	To raise/lower all the Sequin devices of all heads at the same time	130
1-2.	To raise/lower Sequin devices individually	131
1-3.	To perform Color Change manually	132
1-4.	To replace Sequin 1 with Sequin 2 (Step unit)	132
1-5.	To replace Sequin 1 with Sequin 2 (Design data in a batch)	134
2.	Automatic Lubrication System	135
2-1.	To operate Lubrication System	135

Chapter 9 Parameter (Setting item)

[Important]

About parameter display on the operation panel

All parameters are explained in this chapter. However, some parameters, which could affect embroidery quality if they are changed easily, are set to be hidden at shipment and they can not be changed.

To display or change them, input a password.

For details of the password, consult the distributor.

1.	Display setting of parameter.....	138
1-1.	To hide all parameters.....	138
1-2.	To display the desired parameter only.	139
1-3.	To hide the desired parameter only.....	140
1-4.	To display all parameters.	142
2.	Parameter.....	143
2-1.	Page P1.....	143
	1 Auto Color Change (AC)	143
	2 Auto Start (AS)	143
	3 Auto start at same color	144
	4 Auto Start after auto data set	144
	5 Frame type, FS mode.....	144
	6 Total Stitch Counter.....	145
	7 Start inching	145
	8 Inching after ATH	145
	9 Auto jump	146
	10 Jump Convert.....	146
2-2.	Page P2.....	147
	11 F.B./F.F. Stitch unit.....	147
	12 Auto F.B. after T. detection	147
	13 Overlap Frame Back	148

	14 Halt before F.B./inching	148
	15 R.P.M. limit by needle position	148
2-3.	Page P3	149
	21 Thread trim length.....	149
	23 Sewing start return stitch	150
	24 Tie stitches.....	151
	25 Upper thread lock timing.....	152
	26 Upper thread detection	152
	27 Under thread detection	153
	29 Auto origin return	154
	30 Return the frame after manual frame travel.....	154
2-4.	Page P4	155
	32 Language.....	155
	33 Preset Halt by stitches	155
	34 Preset Halt by Data.....	155
	35 Preset Halt by Designs	156
	36 Preset Halt by Lubrication.....	156
	37 Preset halt (1st before end code)	156
	38 Table Offset Position	156
	39 Optional position	157
	40 Needle Bar Color	157
2-5.	Page P5	158
	41 Lubrication cycle	158
	42 Lubrication cycle (Head).....	158
	43 Sequin feed amount (R).....	159
	44 Sequin feed amount (L)	160
	45 Auto lifting - Sequin device	161
	46 Boring step	162
	50 Detailed Network information.....	162
2-6.	Page P7	163
	[71 R.P.M. setting]	164
	1 Speed change data	164
	2 Low speed r.p.m. / Low speed code r.p.m. (Input of a password is necessary)	164
	3 Start/ATH inching r.p.m. (Input of a password is necessary)	165
	[72 Stitch Compensation]	165
	1 Backlash (X) (Input of a password is necessary)	165
	2 Backlash (Y) (Input of a password is necessary)	165
	3 Satin Stitch (area) (Input of a password is necessary)	166
	4 Satin Stitch (density) (Input of a password is necessary).....	166

5 Satin Stitch (Expansion) (Input of a password is necessary)	166
[73 Design Setting]	167
2 Condition data (Input of a password is necessary)	167
[74 Frame Setting]	167
3 Frame weight (Input of a password is necessary).....	167
4 Frame Travel Speed, Frame Stepping Method (Input of a password is necessary) .	167
5 Frame start timing(Input of a password is necessary).....	168
6 Frame start timing (FS mode) (Input of a password is necessary).....	168
[75 ATH Setting]	168
1 ATH (Input of a password is necessary)	168
3 Sensitivity of ATH error detection (Input of a password is necessary)	169
4 Under-thread opening operation (Input of a password is necessary).....	169
[76 Stop position]	170
1 Stop at Lower Dead Point (Input of a password is necessary).....	170
2 Return Frame at Lower dead point (Input of a password is necessary).....	170
[77 Optional Device (Hardware)]	170
1 Sequin device (R) (Input of a password is necessary)	170
2 Sequin device (L) (Input of a password is necessary).....	171
3 Insertion of jump at sequin (Input of a password is necessary)	171
4 Boring device (Input of a password is necessary).....	171
8 Air Pressure Sensor (Input of a password is necessary)	172
9 Auto lubrication system (Input of a password is necessary)	172
11 Bobbin changer (Input of a password is necessary)	172
12 LED lamp (Input of a password is necessary).....	172
18 Seed Beads Device (Input of a password is necessary)	173
[78 Optional device (Software)]	173
1 Network (Input of a password is necessary)	173
2 Network name (Input of a password is necessary)	175
2-7. Page P8.....	176
[84 Password (functional limit)]	177
1 Password (Functional limit level) (Input of a password is necessary)	177
2 Functional limit level	177
[85 Machine adjustment]	177
1 Date and time (Input of a password is necessary)	177
2 Total number of thread breakage (Input of the password is necessary)	178
3 Error stack (Input of a password is necessary)	178
4 Memory Process (Input of a password is necessary).....	179
5 Machine log data Download (Input of password is necessary)	180

6 Display of main shaft stop position (Input of a password is necessary)	180
7 Display of needle position angle (Input of a password is necessary)	181
8 Time for detect power failure (Input of a password is necessary)	182
9 Main Shaft Brake (Input of a password is necessary)	182
10 Frame servo lock (Input of the password is necessary)	182
12 Manual frame travel speed (Input of a password is necessary)	182
13 Automatic frame travel speed (Input of a password is necessary)	183
14 Frame weight data install (Input of the password is necessary)	183
15 Software install (Input of a password is necessary).....	183
17 Sequin chip feed (Input of a password is necessary)	184
20 Needle bar upper dead point adjustment (Input of a password is necessary).....	184
21 Air lifter adjustment (Input of a password is necessary)	184
[86 Machine condition]	185
1 Machine type, machine number (Input of a password is necessary).....	185
2 Head interval (Input of a password is necessary).....	185
3 Y-axis frame size (Input of a password is necessary)	185
4 Frame spec. (Input of a password is necessary).....	186
5 Overlap (Input of a password is necessary)	186
6 Maximum RPM (Input of a password is necessary)	186
11 Frame weight level (Input of a password is necessary).....	187
12 X Stitch Length Adjustment (Input of the password is necessary).....	187
13 Y Stitch Length Adjustment (Input of the password is necessary).....	188
14 X Stitch Length Adjustment (FS mode) (Input of the password is necessary).....	188
15 Y Stitch Length Adjustment (FS mode) (Input of the password is necessary).....	188
[87 Panel setting]	189
1 Sound volume (Input of a password is necessary)	189

Chapter 10 Outline of functions

1.	Condition data	192
2.	Offset Frame Travel.....	193
2-1.	Automatic Offset	193
2-2.	Automatic free-setting offset.....	194
2-3.	Auto Color Change Offset	195
3.	Trace	196
4.	FS mode	197
4-1.	Sewing comparison	198
4-2.	To improve embroidery results further.....	200
4-3.	Optional parts	200
4-4.	Example of Usage	201
5.	Head group.....	202
5-1.	Outline	202
5-2.	An example when using head group	204
6.	Marking.....	208
6-1.	Outline	208
6-2.	An example of using Marking	210

Chapter 11 Troubleshooting, maintenance

1.	Troubleshooting.....	212
1-1.	Stop factor (Code No.)	212
1-2.	When the machine does not sew well	219
2.	Maintenance	221
2-1.	Cleaning	222
2-2.	Lubrication.....	226
2-3.	Greasing.....	228
2-4.	Inspection	230
2-5.	Repair	230
3.	Items to notice when attaching tension base cover.....	231
4.	Adjustment of Snap-fit middle thread guide.....	232
5.	Upgrading of software (Input of a password is necessary).....	235

Chapter 12 Appendix

1.	Specification of the machine	240
1-1.	Electrical specifications.....	240
1-2.	Ambient noise level.....	240
1-3.	Machine weight.....	240
2.	Electrical system diagram (3-phase 200 to 220 V)	241
3.	Dip switch setting.....	247
3-1.	IDU-13*card	247
3-2.	CPU-13*Card.....	248
3-3.	Head 13*card.....	249
4.	Terminology	254

1. Handling of each section

(1) I want to release the lock of the emergency stop switch.

→Refer to "2-2. Emergency stop switch" of page 12.

(2) I want to change the frame travel speed.

→Refer to "7-1. To move frame" of page 52.

2. Preparation before embroidering

(1) I want to embroider the design saved in USB memory.

→Refer to "3-1. To input design in USB memory to machine memory" of page 40.

(2) I want to embroider the design saved in the machine memory.

→Refer to "4. To decide embroidery design (Data Setting)" of page 46.

(3) I want to delete the design saved in the machine memory.

→Refer to "1. To delete design" of page 76.

(4) I want to delete the design saved in USB memory.

→Refer to "1-3. To delete design in USB memory" of page 78.

(5) I want to copy the design saved in the machine memory.

→Refer to "4-1. To copy design" of page 91.

(6) I want to change the name of the design saved in the machine memory.

→Refer to "2-3. To change design name" of page 82.

(7) I want to set the color change sequence.

→Refer to "5-2. To decide needle bar order" of page 48.

(8) I want to check the size of the design and the setting contents.

→Refer to "6-1. To check size of design and setting contents" of page 50.

(9) I want to move the frame to check the size of the design.

→Refer to "7-2. To check if design fits in embroidery space (Tracing)" of page 53.

(10) I want to change the size of the design to embroider.

→Refer to "2. To change size of design/To change direction of design (Data conversion)" of page 104.

(11) I want to embroider repeatedly.

→Refer to "3. To embroider repeatedly (Repeat)" of page 108.

(12) After finish of embroidering, I want to move the frame to the front automatically.

→Refer to "1-1. To move the frame automatically at the start and the end of embroidery (Automatic Offset)" of page 98.

(13) I want to change the detecting sensitivity of the upper thread breakage.

→Refer to "26 Upper thread detection" of page 152.

(14) I want to return the frame automatically when the thread breaks.

→Refer to "12 Auto F.B. after T. detection" of page 147.

(15) I want to make the positioning data of applique.

→Refer to "Marking" of page 125.

(16) I want to embroider by using "Head group".

→Refer to "Head group" of page 124.

(17) I want to stop the machine in the middle of embroidering.

→Refer to "33 Preset Halt by stitches" of page 155.

3. From start to completion of embroidering

(1) I want to specify the number of stitches to return the frame. You want to advance the frame.

→Refer to "1-2. To perform "To return frame", "To advance frame"" of page 61.

(2) I want to return by Stop code. I want to advance the frame.

→Refer to "1-3. To perform "To return frame", "To advance frame"" of page 62.

(3) I want to trim the thread manually.

→Refer to "2-1. To trim thread" of page 63.

(4) I want to change the color manually.

→Refer to "2-2. To change color" of page 64.

- (5)** I want to return the frame to the start position in the middle of embroidering.
→Refer to "3-3. To return frame to the start position (Start position return)" of page 66.
- (6)** I want to return the frame to registered position in the middle of embroidering.
→Refer to "3-4. To move frame to the registered position (Offset return)" of page 66.
- (7)** I want to return the moved frame to the previous position in the middle of embroidery.
→Refer to "3-2. To return the moved frame to the previous position (Manual Offset)" of page 65.

4. Optional device

- (1)** I want to raise/lower Sequin devices at all heads together in a batch.
→Refer to "1-1. To raise/lower all the Sequin devices of all heads at the same time" of page 130.
- (2)** I want to raise/lower Sequin devices ESQ-C individually.
→Refer to "1-2. To raise/lower Sequin devices individually" of page 131.
- (3)** I want to replace Sequin 1 of Sequin device ESQ-C with Sequin 2.
→Refer to "1-4. To replace Sequin 1 with Sequin 2 (Step unit)" of page 132.
→Refer to "1-5. To replace Sequin 1 with Sequin 2 (Design data in a batch)" of page 134.
- (4)** I want to change various settings of Sequin device.
→Refer to "43 Sequin feed amount (R)" of page 159.
→Refer to "44 Sequin feed amount (L)" of page 160.
- (5)** I want to change setting of Boring device.
→Refer to "46 Boring step" of page 162.

What do you want to do from now ?

Chapter 1













Items that must be followed carefully

1. To use this machine safely	2
2. Warning labels	5
3. Checking before starting operation.....	7

1. To use this machine safely



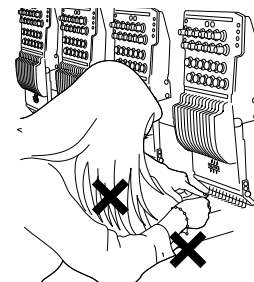
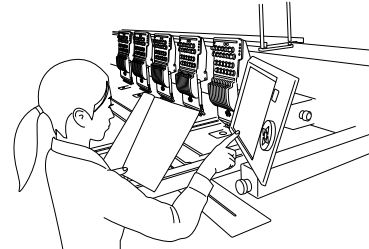
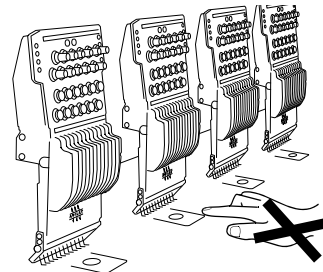

1-1. Warning

WARNING



-  This machine is designed for industrial use. Use this machine for semi- or finished textile products and similar materials. Using the machine for other purposes must be avoided.
-  Do not stand on the machine.
-  Do not use a device such as a cellular phone that generates microwave near the control circuits of the power supply box, the operation panel box, etc. Microwave may cause malfunctioning of the machine.
-  Do not detach covers for the shaft and the pulley. Also, do not run the machine without the covers.
-  Do not have your hands, etc. access to the vicinity of needle during operation. Otherwise, sticking of needle could injure you.
-  During operation, do not access your hands and/or face to moving sections. Especially, it is dangerous around needle, rotary hook, take-up lever, pulley and speed-reduction box.
-  Read this book thoroughly and understand the contents of operation certainly. Then, operate the machine.
-  Wear proper clothes and tidy up yourself so that you can smoothly perform the operation.
-  A single operator should operate the machine in principle. If plural operators are working together, make sure that no one is working near the moving units of the machine before starting the machine.
-  Use the machine under the environment where access can be supervised so that unauthorized person does not operate the machine. Supervise children so that they do not access to the machine.
-  Only the persons who are sufficiently trained for the operation must operate the machine.
-  The rear of the machine is not a working area. If you have to move to the rear of the machine, make sure to turn OFF the main switch.
-  Stop the machine before threading into the needle and checking the finish of embroidery.



 **WARNING**

-  Do not damage, modify or heat the power or other cables. Do not exert undue force to them, either. Otherwise the cables will be damaged causing fire and electric shock.
-  Insert the power cable plug fully. If a metallic part etc. touches an electrode in the plug, it may cause fire and/or electric shock.
-  Keep away electrical units from water and chemicals. Entry or splashing of them into electrical units leads to short circuits, causing fire, electric shock and other troubles. If water or other chemicals enter the unit, turn OFF the power switch, shut OFF the primary power of the machine and contact your local distributor.
-  Before opening the electrical boxes, be sure to turn OFF the power switch of the machine and shut OFF the primary power. If not, it may cause electric shock.

1-2. Caution **CAUTION**

-  Use the machine with about 70% of the maximum speed as "Operation for total fitting" for about one week after installing this machine. By performing operation for total fitting, life of the machine will become longer, which will be useful to avoid unexpected troubles.
-  Do not use bent needles or needles that are not suitable for the material. Be sure to turn OFF the power switch after working, and turn OFF the primary power supply.
-  Do not put things on the machine table.

! CAUTION

! Control the operation noise in the environment.

This machine is designed to reduce noise during operation. To improve the sound insulation performance in a factory still more, use the interior finish materials which show high sound insulating performance for the walls, ceiling, and floor of the factory.

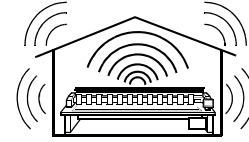

! Install the machine on a sturdy floor.

The floor structure must be strong enough to bear the machine weight (indicated on the spec. plate).

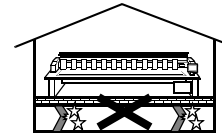

! Avoid dust and moisture.

Since dust and moisture lead to dirt and rust on the machine, use the machine in an environment of facility of air conditioner, and clean the working place periodically. Use caution not to expose the machine to direct wind from the air conditioner so that embroidery threads do not become disheveled.

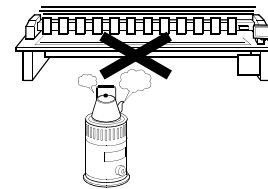

Humidity: 30 to 95% RH (relative humidity) without condensation

Ambient temperature: 5 to 40°C (during operation), -10 to 60°C (during storage)

! Avoid direct sunlight.

If the machine is exposed to direct sunlight over an extended period of time, the machine body may be discolored or deformed. Put curtains or shades to prevent the machine from direct sunlight.

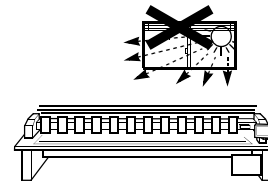

! Provide enough space for maintenance.

Taking account of workability when maintaining and inspecting the machine, provide working area of 50 cm or more to right and left, and 55 cm or more to rear directions for the machine against obstacles such as walls.

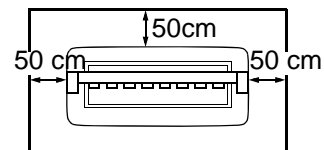

! Pay attention to interference of radio wave.

Although the machine is designed not to affect radio wave interference to other equipments, there could be cases where it causes interference depending on operation environment and type of other equipment. If such problems arise, install the equipment with a space from the machine as big as possible.

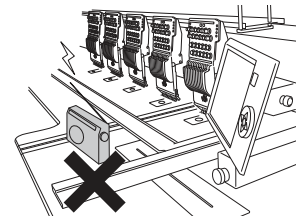

2. Warning labels

The machine has warning labels that bear instructions for safe operation. Machine operators must follow the instructions shown on the warning labels. Do not detach the warning label nor make them illegible by painting, etc. If the warning label is missed or damaged, contact your TAJIMA distributor.

[A]  There could be danger of burning, death or severe injury due to electric shock. Persons except the service personnel designated by Tajima should not open the covers. When you open the cover, turn OFF the power switch and wait for four minutes or more.

[B]  There could be danger of being caught.
Persons except the service personnel designated by Tajima should not open the covers.

[C]  You could be burnt by high temperature. Do not touch carelessly.

[D] Pay attention around needle.

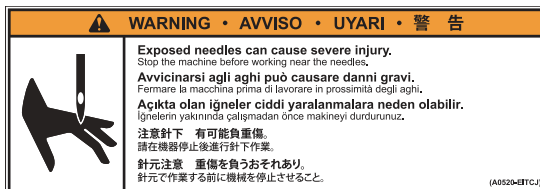

[E] Pay attention not to be clipped into the machine.

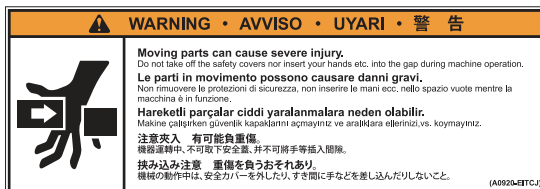

[F] Pay attention not to be caught into the machine.



[G] Pay attention to rotary hook.



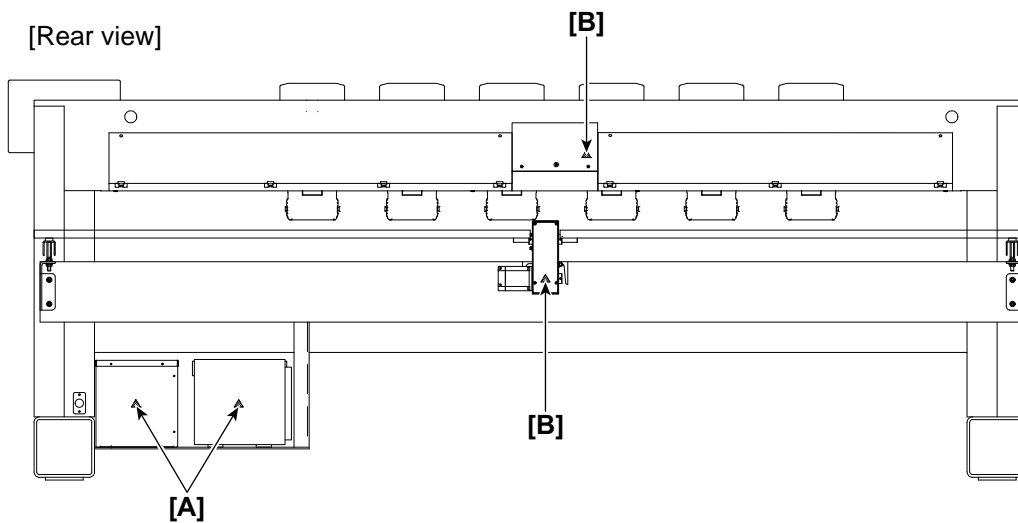
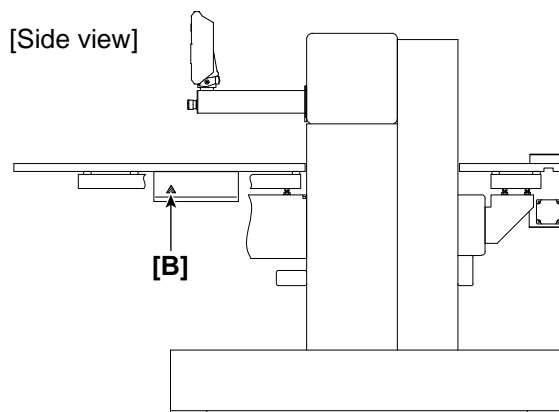
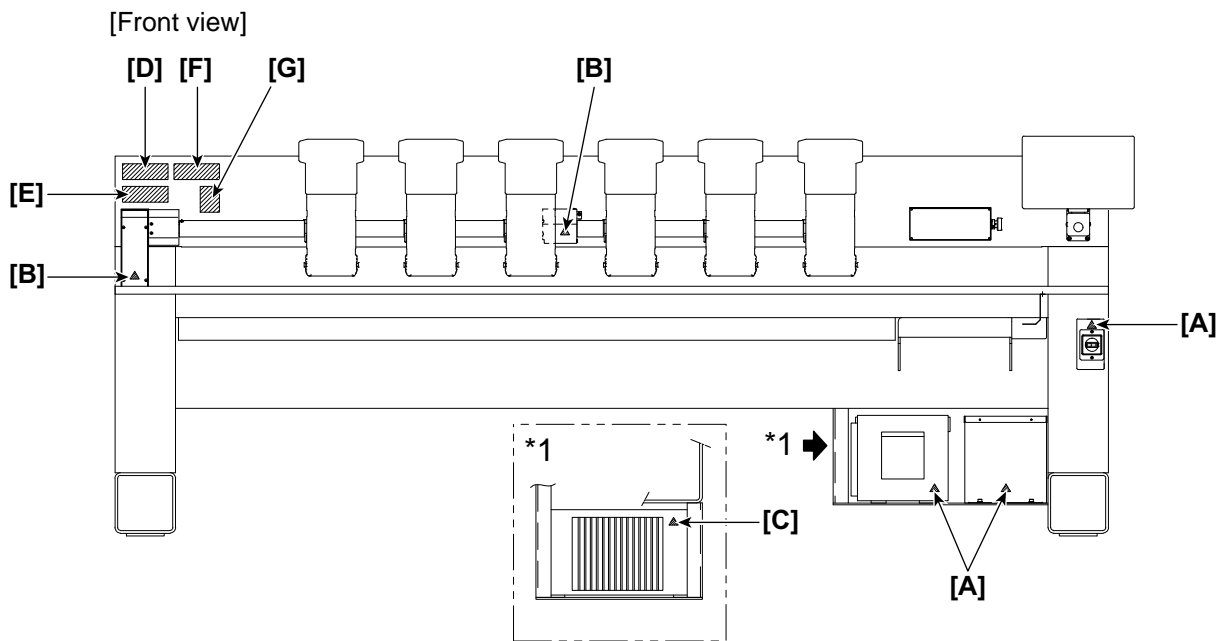

3. Checking before starting operation

Before starting work, execute inspection (including cleaning, lubrication) of each part.

Spot	Check
Covers	Covers might be attached incorrectly.
Upper thread	The thread might be passed incorrectly to each part.(→p.37) The tension might be inadequate. The thread might be entwined around frame/drive system.
Under thread	The under thread (bobbin case) might be set to rotary hook incorrectly. The tension might be inadequate.
Needle	The needle might be bent. The direction of needle might have been wrong. The needle might be broken.
Rotary hook	Cleaning/lubrication might be performed in inadequate frequency. (→p.226)
Right LED of tension base	The right LED of the head to use might not been lit in green.(→p.20)

Chapter 2

Name and way to use of each part

- 1. Name of each part 10
- 2. How to use each part..... 11
- 3. Tension base 20

1. Name of each part

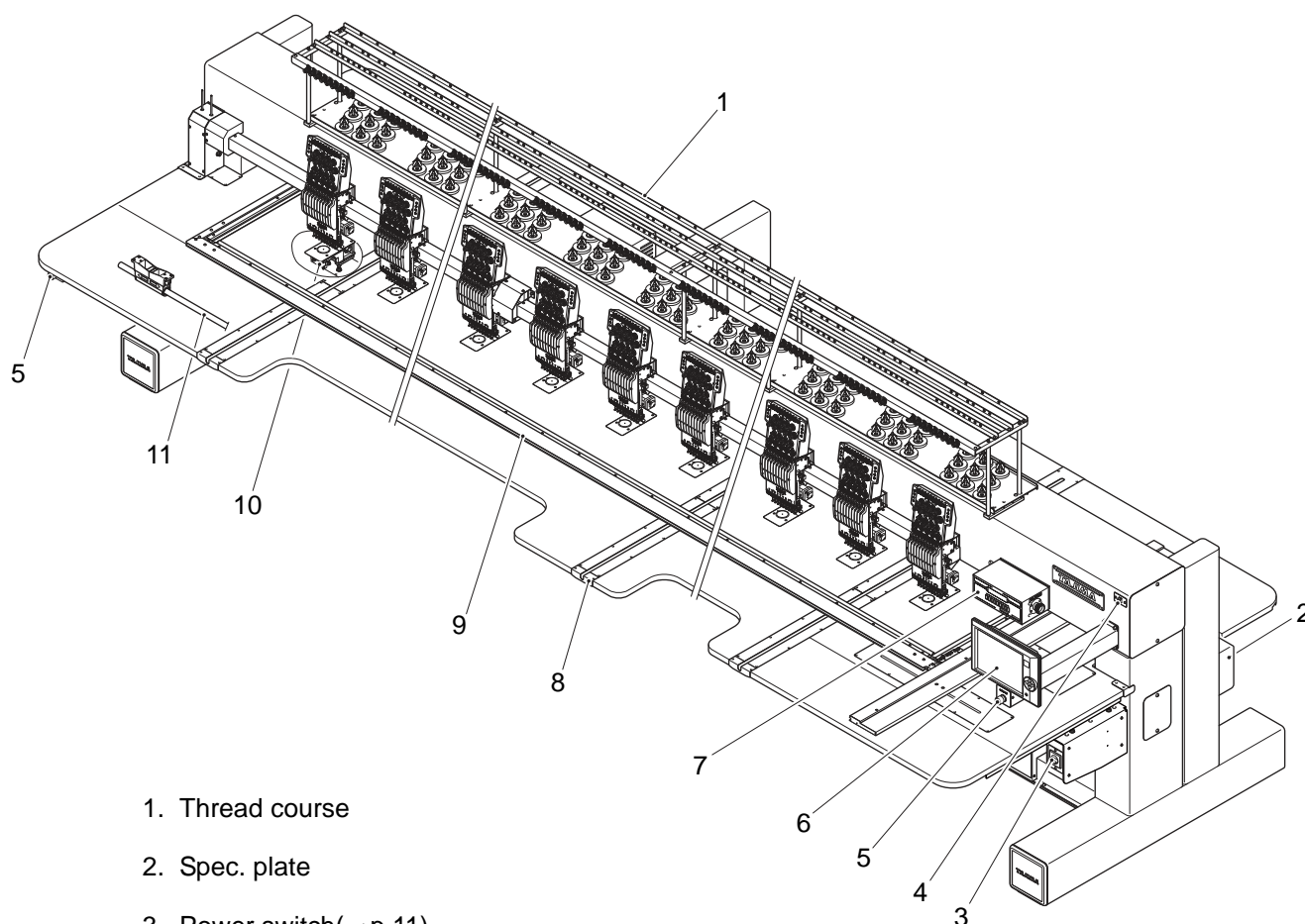

1. Thread course
2. Spec. plate
3. Power switch(→p.11)
4. LAN port(→p.19)
5. Emergency stop switch(→p.12)
6. Operation panel(→p.18)
7. Color change system
8. Table lid
9. Border frame
10. Rotary hook base
11. Bar switch(→p.13)

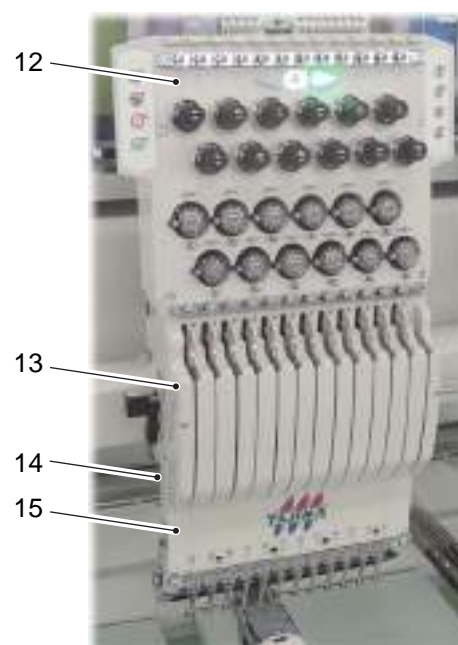



12. Tension base(→p.20)
13. Snap-fit middle thread guide
(→p.39)
14. Clutch lever(→p.17)
15. Needle bar case

2. How to use each part

2-1. Power switch

When turning ON the power, set the power switch to "ON". When turning OFF the power, set this switch to "OFF". If the emergency stop switch is pressed or the power is shut off during operation, the power switch will be positioned at the middle.

CAUTION

-  To turn ON the power again, wait for 30 seconds or more. The system sometimes may not start up normally.
-  Do not turn ON the machine power with the USB memory connected to the operation panel. The system sometimes may not start up.



Middle position between ON and OFF



To cancel, turn "OFF" once, then turn "ON".

To lock the power switch, use the padlock.



2-2. Emergency stop switch

CAUTION

 When performing this operation, do not put your hands, etc. on the table. Moving the frame could injure you.

The emergency stop switch is equipped as a measure for safety. Pressing this switch during operation will turn OFF the power and stop the machine. At this time, the power switch will be switched to the middle position.

Below operation panel



Below left-side table



[How to resume]

- (1) Turn the switch to the right. The lock will be released.



- (2) The power switch is set to "Middle position". Turn "OFF" → "ON" the power switch. At this moment, wait for 30 seconds or more.



- (3) After the electricity is connected and the power starts up, press icon G. Code No.2E3 will be reset.

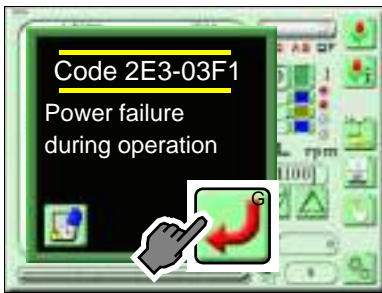

- (4) Press either one of following 2 icons according to embroidery condition. Pressing icon will cause the frame to move.

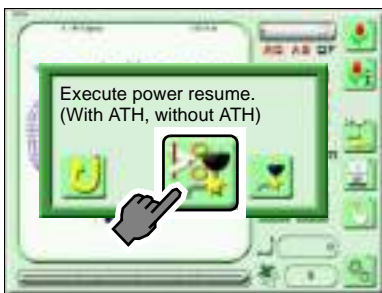

The frame will be moved after thread trimming.



The frame will be moved without thread trimming.

- (5) After frame travel, the frame may move forward by some stitches from the previous position. Check the frame position, and restart embroidery after returning the frame.

2-3. Bar switch

⚠ CAUTION

⚠ Before starting the machine, pay enough attention to the surrounding safety. Moving needle bar and/or frame could injure you.

Bar switch



(1) During stop

Move the bar switch to the right and release it immediately.	Operation starts.
Move the bar switch to the right and hold it at that position.	The machine will work slowly. When released, the machine will run normally.

a. You want to return the frame.

To return the frame:

This function makes the frame move to the direction which stitches return with the needle bar stopped.

Check if the current setting is Frame Back (to return the frame). (→p.27)

Move the bar switch to the left according to the chart below.

CAUTION

 When performing this operation, do not put your hands, etc. on the table. Moving the frame could injure you.

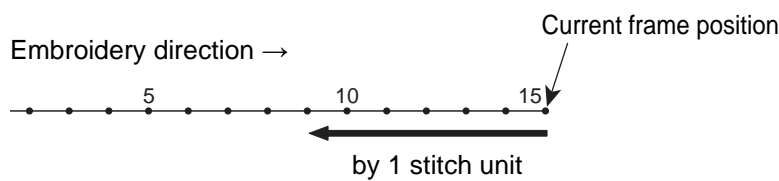
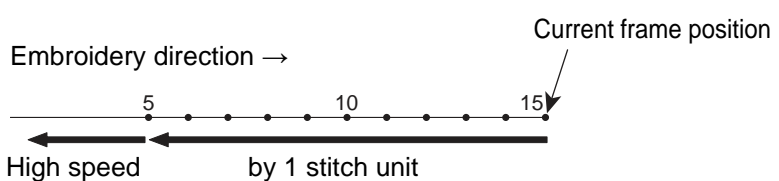
Move the bar switch to the left, and keep at the position (up to ten stitches).	<p>The frame will return by 1 stitch unit up to 10 stitches. To stop., release it.</p> 
Move the bar switch to the left and hold it at that position. (11 stitches or more)	<p>The frame will return by 1 stitch unit up to 10 stitches. For 11 stitches or more, the frame will return at high speed.^[1]</p> <p>To stop the machine, move the bar switch to the left again.</p> 

[1]The frame returning speed can be selected from the frame feeding amount (one, three or five stitches). (→ p.147)

b. You want to advance the frame.

To advance the frame:

This function makes the frame move to the direction which stitches advance with the needle bar stopped.

Check if the current setting is Frame Forward (to advance the frame). (→p.27)

Move the bar switch to the left according to the chart below.

! CAUTION	
<p>⊘ When performing this operation, do not put your hands, etc. on the table. Moving the frame could injure you.</p>	

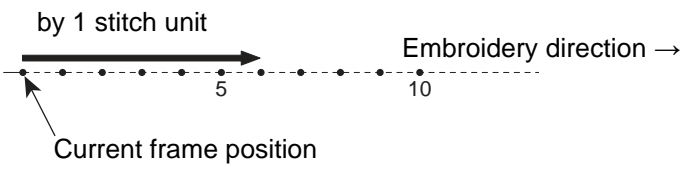
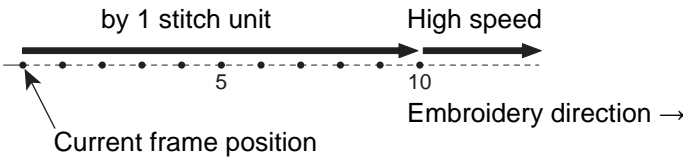
<p>Move the bar switch to the left, and keep at the position (up to ten stitches).</p>	<p>The frame will advance stitch by stitch up to 10 stitches. To stop, release it..</p> 
<p>Move the bar switch to the left and hold it at that position. (11 stitches or more)</p>	<p>The frame will advance by 1 stitch unit up to 10 stitches. For 11 stitches or more, the frame will advance at high speed.^[1]</p> <p>To stop the machine, move the bar switch to the left again.</p> 

[1]The frame advancing speed can be selected from the frame feeding amount (one, three or five stitches). (→ p.147)

(2) During operation

<p>Move the bar switch to the left and release it at once.</p>	<p>Operation stops.</p>
--	-------------------------

2-4. Table offset switch

This operation facilitates threading by moving the frame to the rear (table offset position) at thread breakage. This switch is supported to some model only and equipped under the table.

When you want to change the table offset position, refer to the detail page.(→p.156)

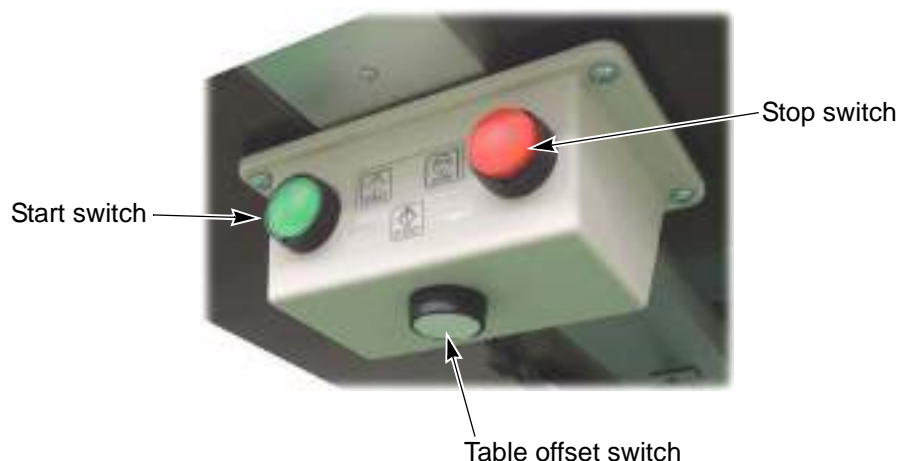

(1) Occurrence of thread breakage

! CAUTION	
<p>⊘ When performing this operation, do not put your hands, etc. on the table. Moving the frame could injure you.</p>	

The frame movement differs depending on the way of pressing the table offset switch.(a, b in the chart below)

a.Press the table offset switch and release it immediately.	the frame will move to the table offset position.
b.Press the table offset switch for two seconds or more.	The thread trimming will be executed, and the frame will move to the table offset position.

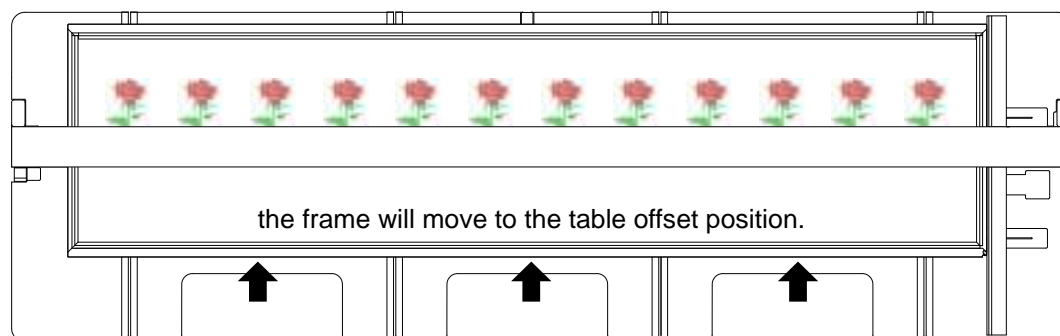

(2) After threading

⚠ CAUTION

⊘ When returning the frame to the original position from the table offset position, do not use the bar switch. Moving the frame could injure you.

The frame movement differs depending on the way of pressing the table offset switch, the start switch and the stop switch. (a, b, c in the chart below)

a.Press the table offset switch.	The frame will move to the previous position.
b.Press the start switch.	The frame will move to the previous position, and the operation will start again.
c.Press the stop switch.	The frame will move to the previous position and return. Releasing the stop switch will stop the frame movement.

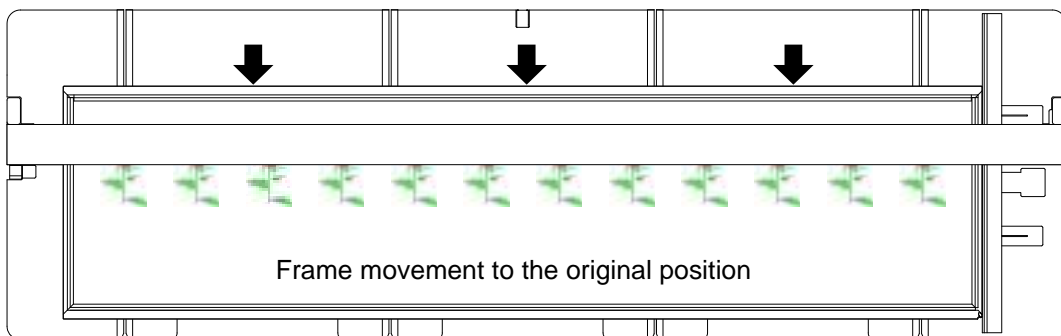

2-5. Clutch lever

This lever suspends needle bar of the head that is not used.

Clutch lever: The needle bar is suspended mechanically.

B switch (Direct command switch): The needle bar is suspended electrically. (→p.23)



Clutch lever

Possible to operate

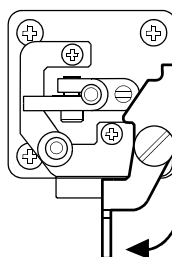

In a state of suspension

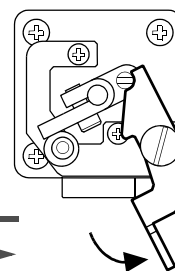

Switching

2-6. Operation panel

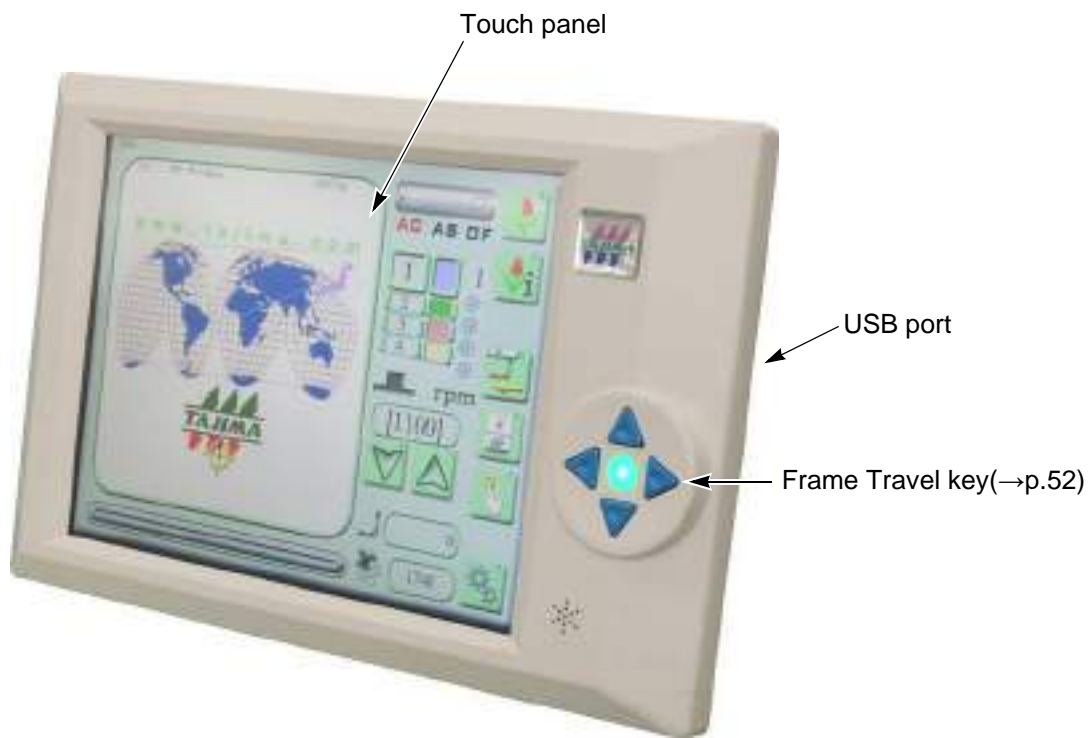

2-7. USB port

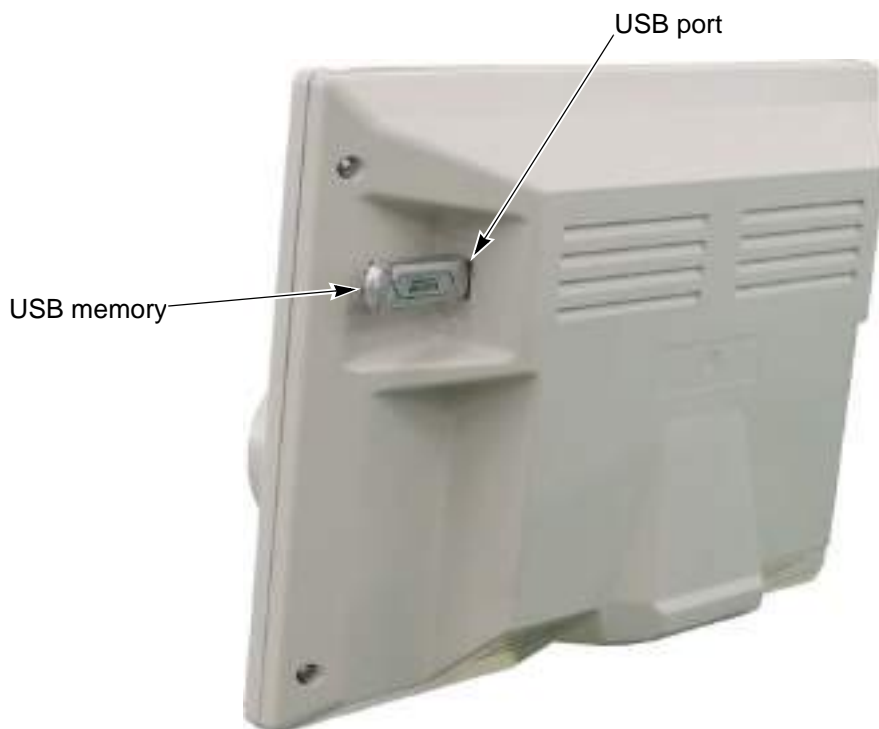







Prepare a commercial item for the USB memory. The USB memory is used for the following cases.

- When registering a design stored in the USB memory into the machine memory.
- When saving the design registered in the memory of the machine into the USB memory
- When the software of the machine is upgraded

Some type and/or capacity of the USB memory could not be used for this machine. In this case, buy the USB memory recommended by Tajima. For details, consult the distributor.

CAUTION

-  Do not turn ON the machine power with the USB memory connected to the operation panel.
-  Do not insert the USB memory in the state of dirt or dust attached to the inside of the connector.
-  Do not push / pull the USB memory during operation of the machine.
-  Insert the USB memory slowly and gently. If the USB memory is inserted impetuously, it could be damaged.
-  Insert the USB memory upright against the port (insertion slot). Oblique insertion could damage to inside circuit board due to interference of connector with the circuit board.
-  Start operation after inserting the USB memory for five or more seconds.

2-8. LAN port

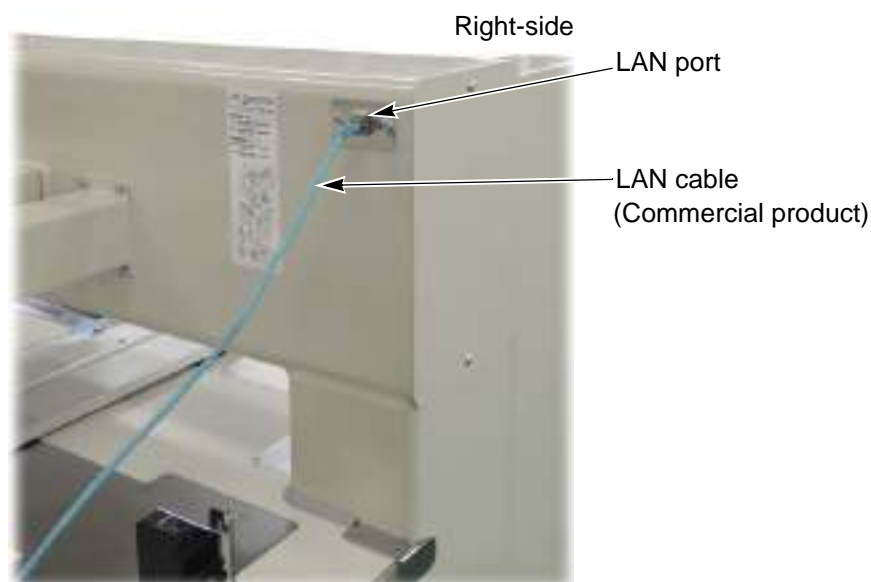

3. Tension base

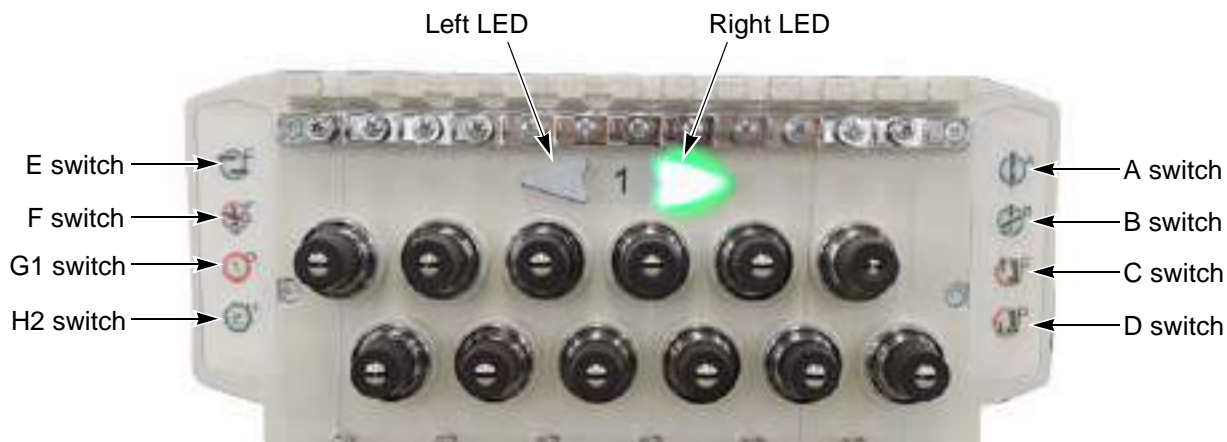



3-1. Right and left LED

<p>Light blue Light blue</p>	<p>It is ready to change to the main screen after turning ON the power.</p>
-----------------------------------	---

3-2. Right LED

<p>Green</p>	<p>During embroidery or ready for embroidery</p>
<p>Blinking in green</p>	<p>While the frame is returned, it is blinking in green at the head without thread breakage.</p>
<p>Red</p>	<p>The upper thread has broken. When you start the machine after returning the frame, this head will perform repair stitches.(→p.57)</p>
<p>Blinking in red</p>	<p>The under thread has broken. When you start the machine after returning the frame, this head will perform repair stitches.(→p.57)</p>

<p style="text-align: center;">Unlit</p> 	<p>The needle bar is suspended.</p>
 <p style="text-align: right;">Orange</p>	<p>Perform forced return stitches at the beginning of the next sewing.</p>

3-3. Left LED

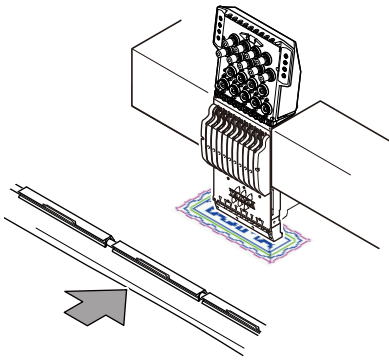
<p style="text-align: center;">Blue</p> 	<p>If the frame is moved by the following operations at stop of the machine in the middle of embroidery, left LED at tension bases of all heads will be lit in blue. Thus, the machine will notify the operator that the frame is not in the original position.</p> <ul style="list-style-type: none"> • Manual Frame Travel • Return to the start position • Offset Return • Frame Travel to an optional position <p>This function is effective only when "Return the frame after manual frame travel" is set to "Yes".(→p.154)</p> <p>How to return the frame to the previous position</p> <p>(1) To continue to embroider as it is</p> <p>Move the bar switch to the right. → The frame will return to the original position and the operation will be started.</p> <p>(2) To return the frame only to the previous position</p> <p>Perform the operation of Manual Offset → The frame will return to the original position.</p> 
---	--

3-4. Direct command switch

(1) A switch

Every time pressing A switch will change the color of the LED lamp.

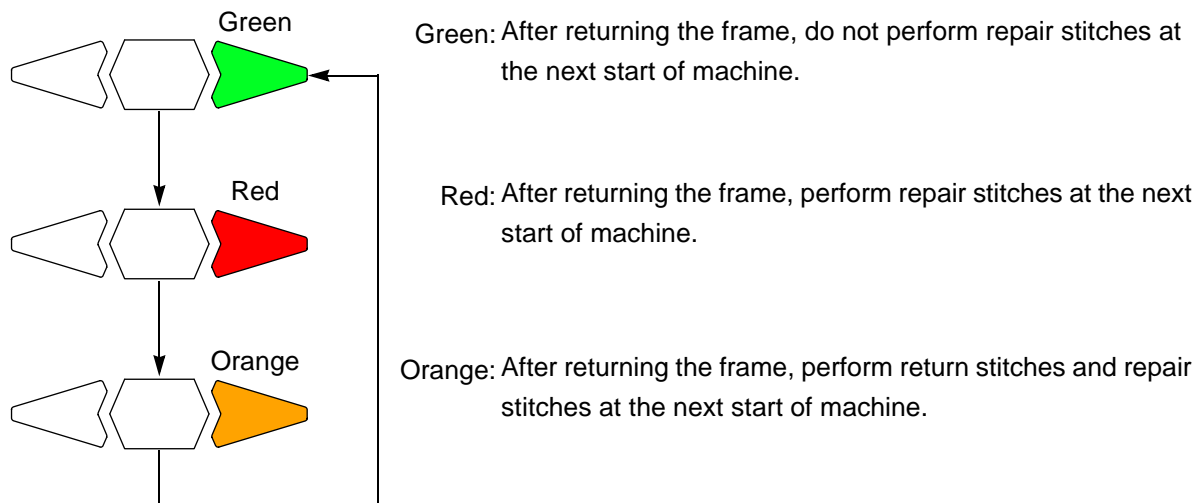

[Various operations]

a. To make the suspended head possible to operate, press A switch one time.

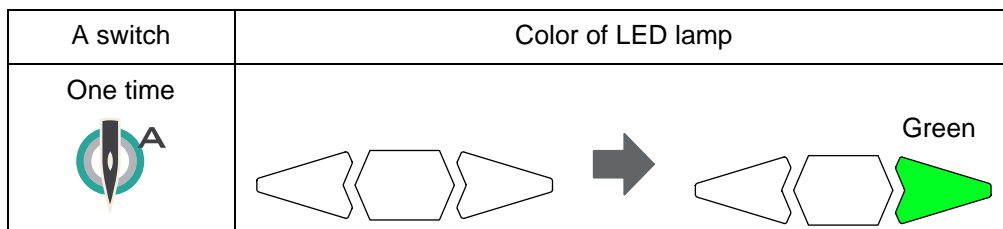

b. When you want to embroider from the position where the frame is returned at the head without thread breakage, press A switch at the head one time.

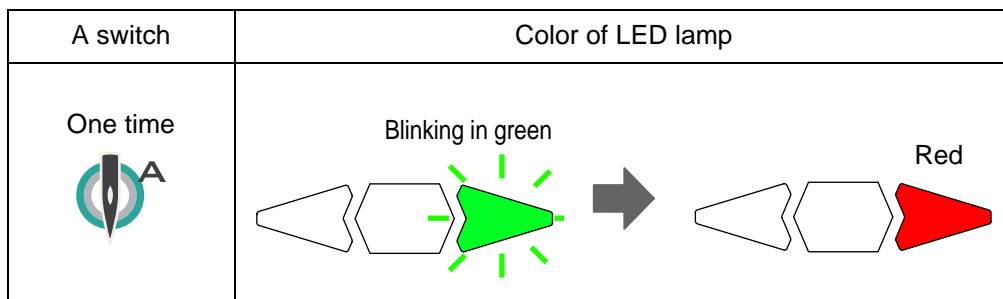

c. When you want to perform forced return stitches at the beginning of the next sewing at the head where repair stitches are selected to perform (LED lamp lit in red), press A switch one time. In case of plural heads where repair stitches are selected to perform, press A switch at any one of these heads.

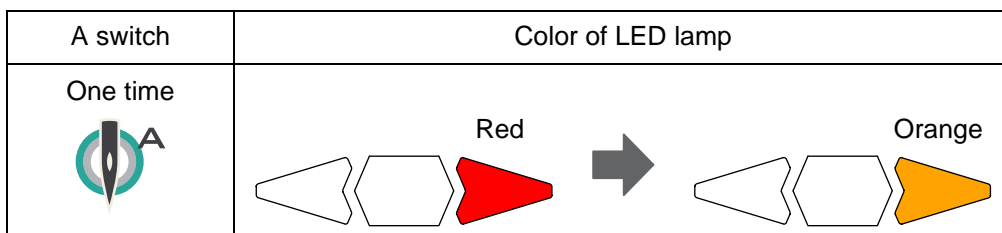

d. When you want to perform forced return stitches from the position where the frame is returned at the head without thread breakage, press A switch twice.

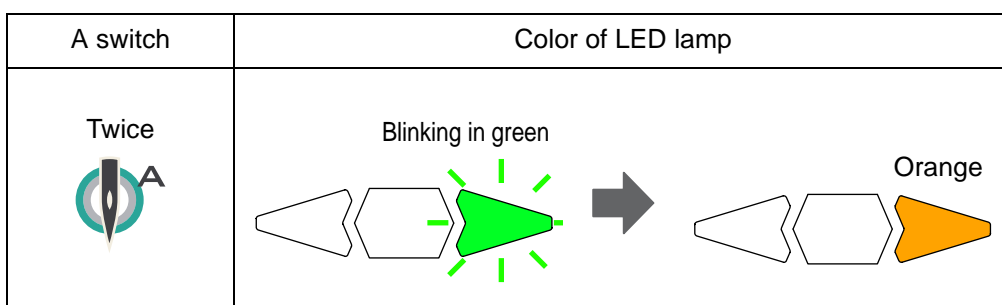

(2) B switch

Press B switch at the head to suspend.

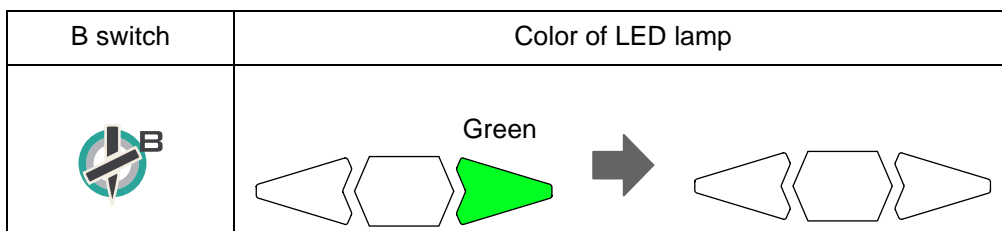

(3) C switch

Raise the needle bars and presser feet for all heads to the retracting position.

 CAUTION
 When performing this operation, do not put your hands etc. near the needle or on the machine table. Moving up of the presser foot could injure you.

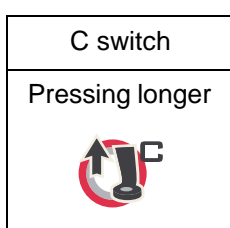

(4) D switch





Lower the needle bar and presser foot of the selected head.

! CAUTION
<p> When performing this operation, do not put your hands etc. near the needle or on the machine table. Moving down of the presser foot could injure you.</p>

D switch
Pressing longer

(5) E switch

This switch will switch Frame Back (to return the frame) or Frame Forward (to advance the frame). This operation is available only when the right LED is lit.

E switch	Lighting condition of lamp	
	<p>Return the frame.</p> <p>White</p>  <p>The lamp will be lit in white for two seconds, and turn to the previous color.</p>	<p>Advance the frame.</p> <p>White</p>  <p>The lamp will be lit in white for two seconds, and turn to the previous color.</p>
		

(6) F switch

This switch will perform manual thread trimming at all heads. Pressing F switch longer will perform thread trimming.

! CAUTION
<p> When performing this operation, do not put your hands etc. near the needle or on the table. Moving needle bar or frame could injure you.</p>

F switch
Pressing longer

Chapter 3

Screen

- 1. Basic screen 26
- 2. Input operation..... 34

1. Basic screen

1-1. Main screen (Screen 1010)

When the power is turned ON, the following screen will appear. From this screen, setting or operation will be started.

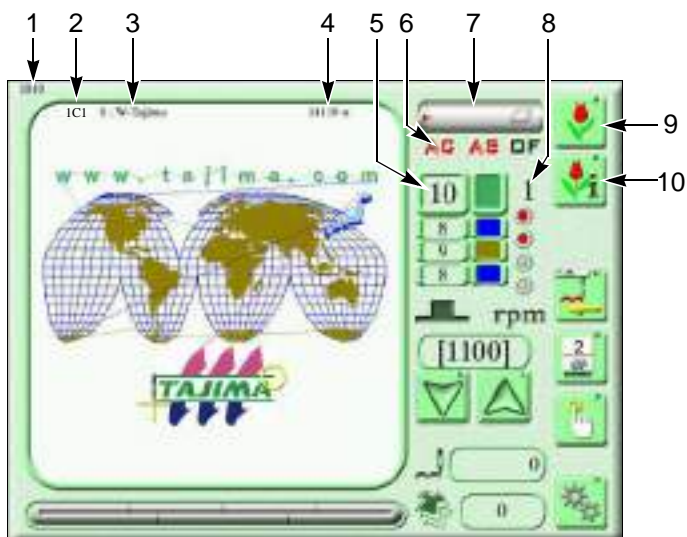



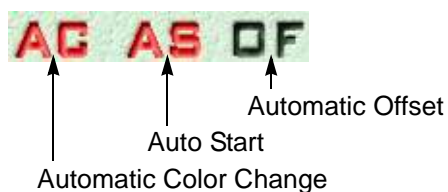



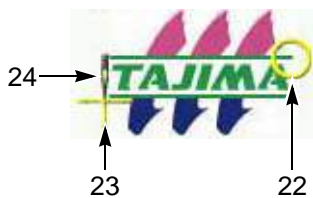
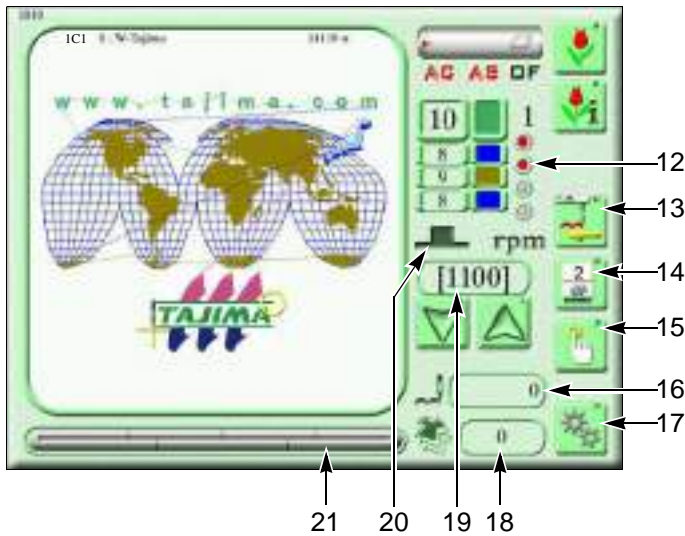

1. Screen number (1010)
2. Stop factor (It will be displayed during stop of the machine.)
3. Design name
4. Total number of stitches of design
5. Needle bar No. of the current step
6. Setting condition of Automatic Color Change, Auto Start and Automatic Offset. Red letters show the setting now.



7. When FS mode is activated, "FS mode" is displayed.
8. Current needle bar step No.
9. Design selection screen(→p.28)
10. Screen of detailed design information (→p.50)



11. Auto Color Change Offset(→p.103)
12. Current setting value of FB (Return the frame) / FF (Advance the frame)
 FB  D FF  D
13. Manual color change screen(→p.64)
Numbers indicate the current needle bar No.
14. Manual operation screen(→p.63)
15. Current number of stitches
16. Setting item screen(→p.137)
17. The number of times of embroideries that have been done up to now
Even if the power is turned OFF/ON, counting will continue.
18. Maximum speed(→p.51)
19. Current main shaft angle
 -  Fixed position
 -  "Main shaft brake" is set to "No".(Blinking →p.182)
 -  Outside of range of fixed position
20. Process status of embroidery
21. End position 
22. Start position 
23. Current needle position 

1-2. Design selection screen (Screen 2000)

Select a design in the machine memory and perform the edit of design, the change of needle bar order, and setting of repeat.

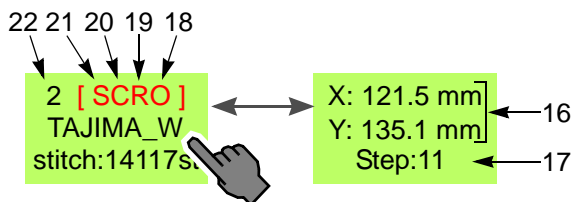
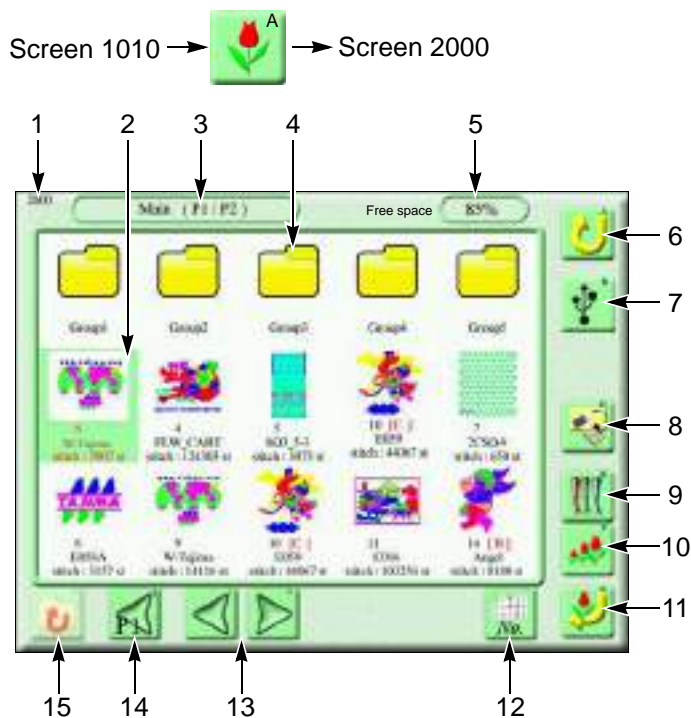

Selecting the design will switch it.



When there is no design in the machine memory, icons 8, 9, and 10 are not displayed.

1. Screen number (2000)
2. Design data stored in the machine memory
3. Screen page
4. Folder
Design data can be saved in the folder. It is not possible to change folder name (Group1 to Group5).
5. Remaining number of machine memory (40,000,000 stitches)
Free space will be displayed as "%". If remaining space becomes 20% or less, remaining number of stitches will be displayed.
6. Return to screen 1010.
7. USB memory screen(→p.29)
8. Design edit screen(→p.75)
9. Needle bar selection screen(→p.48)
10. Screen of scaling up/down and repeat of design(→p.104)
11. Determine the data set.
12. Rearrangement of design
No.:
Name: Alphabetical design name order
Time: Updating order
13. Switch the screen to the next page or the previous page.
14. Return the screen to P1
15. When "Group" folder is selected, return to the screen of "Main" folder.
16. Design size (embroidery space)
17. Number of steps
18. With setting of automatic offset(→p.98)
19. With setting for repeat(→p.108)
20. With setting for scaling up/down of design (→p.104)
21. With setting for step unit(→p.114)
22. Machine memory number

1-3. USB memory screen (Screen 3100)

Screen 1010 → To set USB memory

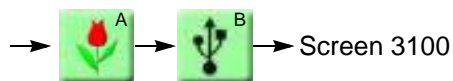

It is possible to select plural designs on this screen.
The below illustration shows an example that four designs are selected.

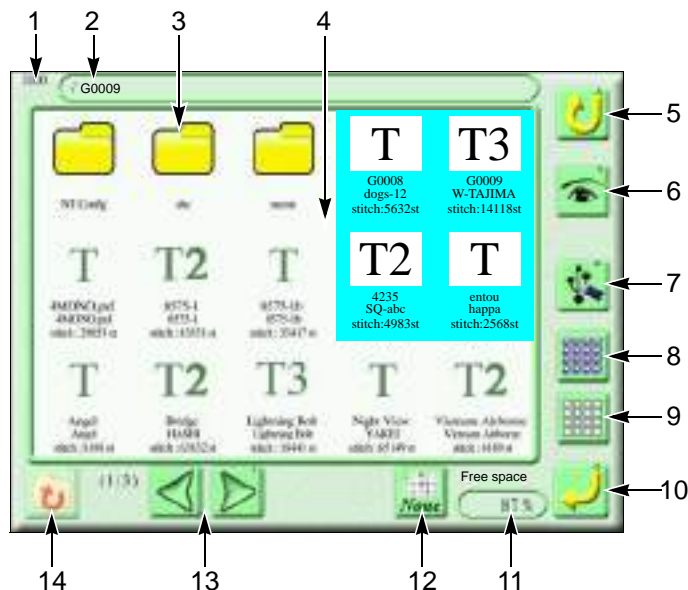

"Selected / not selected" will be switched each time the design is selected.

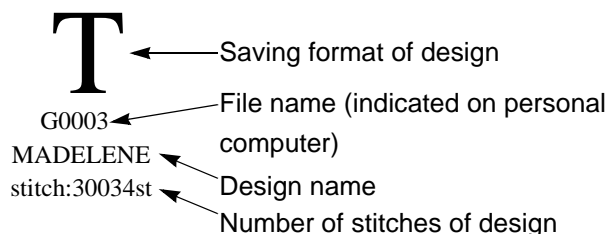
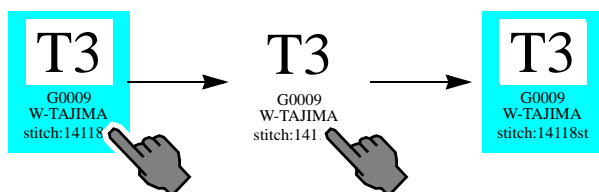

Saving format of design

- T: TAJIMA format (DST)
- T2: TAJIMA binary format (TBF)
- T3: TAJIMA integrated file (TCF)

Depending on saving format of the design, the design except above one will be displayed.

1. Screen number (3100)
2. File name of selected design
3. Folder
It is possible to display up to the third layer directory.
4. Design saved in USB memory
5. The screen returns to the screen 2000.
6. Images of all designs are displayed when pressing this icon without selecting any design. Only an image of this design is displayed when pressing this icon with a design selected.
7. Deletion of a design(→p.78)
It will be displayed only when design is selected.
8. Select all designs.
9. Selecting the design will be canceled.
10. Determine the input data.
11. Machine memory capacity (40,000,000 stitches)
Free space will be displayed as "%". If remaining space becomes 20% or less, remaining number of stitches will be displayed.
12. Rearrangement of design (folder is excluded)
None: Registering order
Time: Updating order
Name: Alphabetical file name order
13. Switch the screen to the next page or the previous page.
14. If the folder is selected, the layer directory will be returned to the upper one.

When reading a design (File name: G003) saved in USB memory by a personal computer, the display will be given as below.

Saving format	Indication on personal computer	Use
T3 (TCF) ^[1]	G0003.TCF	Data integrating T2(CT0, DGF, TBF) and CT1 The following conditions are included in CT1. Message S(→p.47) Message E(→p.47)
T2 (TBF) ^[2]	G0003.CT0	Color Change Sequence, Start Position
	G0003.DGF	Image data
	G0003.TBF	Stitch data of TAJIMA binary format
T (DST)	G0003.DST	Stitch data of TAJIMA ternary format

[1] T3 design is unified by following four files.

TBF (TAJIMA binary format)	CT0 (Condition data)
DGF (Thumbnail data)	CT1 (Message)

[2] T2 design is one set of following three items. However, they are not unified.

TBF (TAJIMA binary format)	CT0 (Condition data)
DGF (Thumbnail data)	

1-4. Data set screen

Select the design and enable to embroider. (Data set)

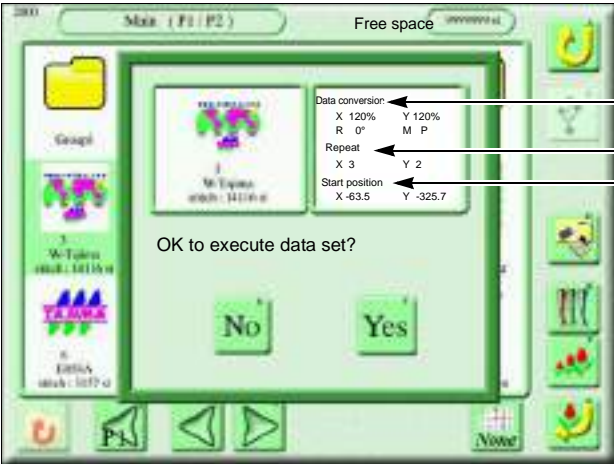
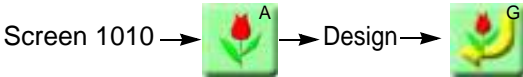

- 1. Setting for scaling up/down of design
- 2. Setting of repeat
- 3. Start position
Frame position where machine started embroidering last time

1-5. Needle bar selection screen (Screen 2010)

Perform general settings about needle bar.

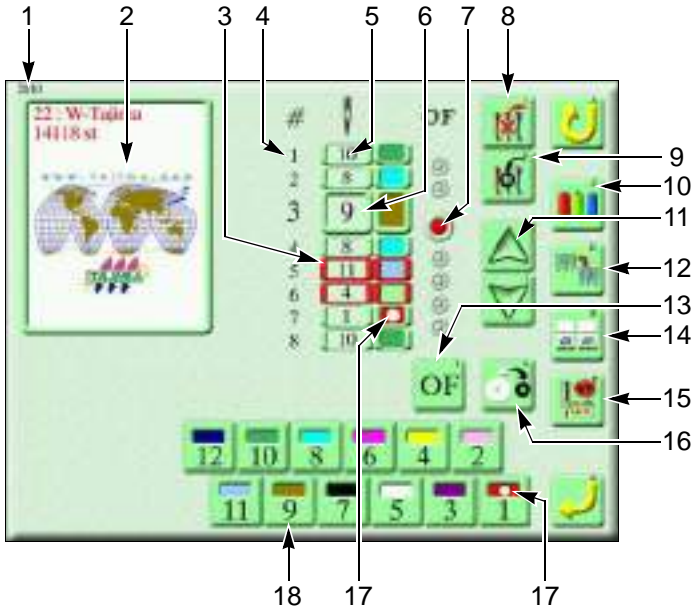
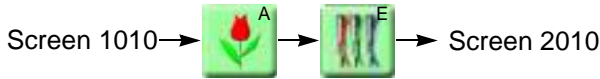

The upper figures 16 and 17 are displayed only when the sequin device ESQ-C is mounted.

1. Screen number (2010)
2. Design being selected
3. Red frame indication of the step
Step that sewing condition was set at "Step unit setting" individually(→p.114)
4. Needle bar step
The section divided by a color change code in the design data. The first section is called step 1.
5. Needle bar No.
In the example of the left figure, step 1 will be sewn at the needle bar number 10.
6. Cursor
Step to perform needle bar selection from now
7. Offset lamp(→p.103)
After step 3 is finished, the frame will move to the offset position.
8. Deletion of needle bar step(→p.113)
9. Insertion of needle bar step(→p.114)
10. Needle bar color(→p.123)
11. Move the cursor up and down.
12. Needle bar conversion(→p.118)
13. Auto Color Change Offset Setting(→p.103)
14. Head selection(→p.119)
15. Step unit setting(→p.114)
Change sewing condition of the desired step.
16. Sequin reversion(→p.132)
Sequins to be output are replaced by reversing a sequin.
17. Sequin reversion(→p.132)
18. Needle bar selection icon

When selecting the head group, the following display will appear.

An example that "4H" is selected

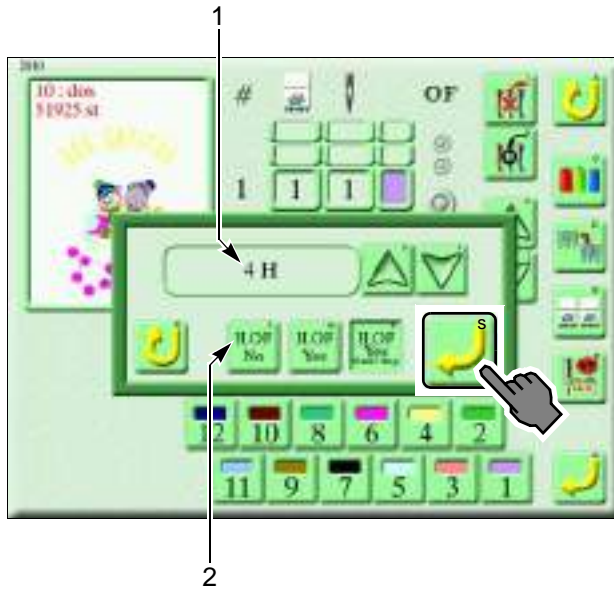

- 1. Head group (→p.124, p.202)
2H, 3H, 4H, TE2H, selected head
- 2. Head Offset
- 3. Needle bar step
- 4. Head to embroider
- 5. Needle bar No.
- 6. Selection of head to embroider

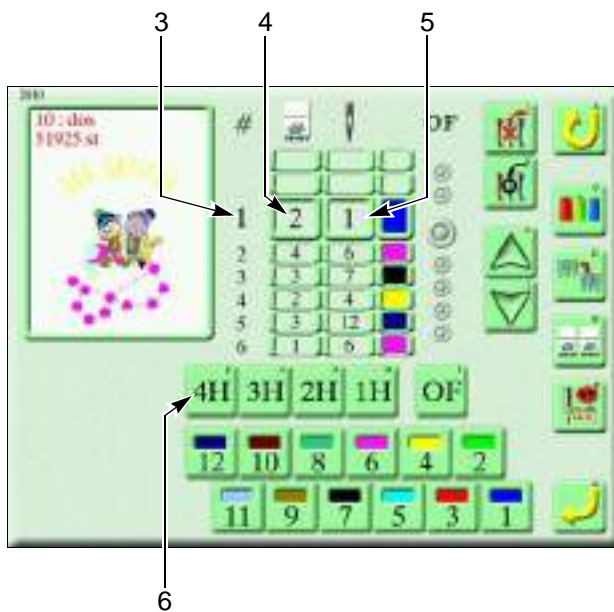

2. Input operation

2-1. To input value

When inputting the value, select the number icon, and press icon G.

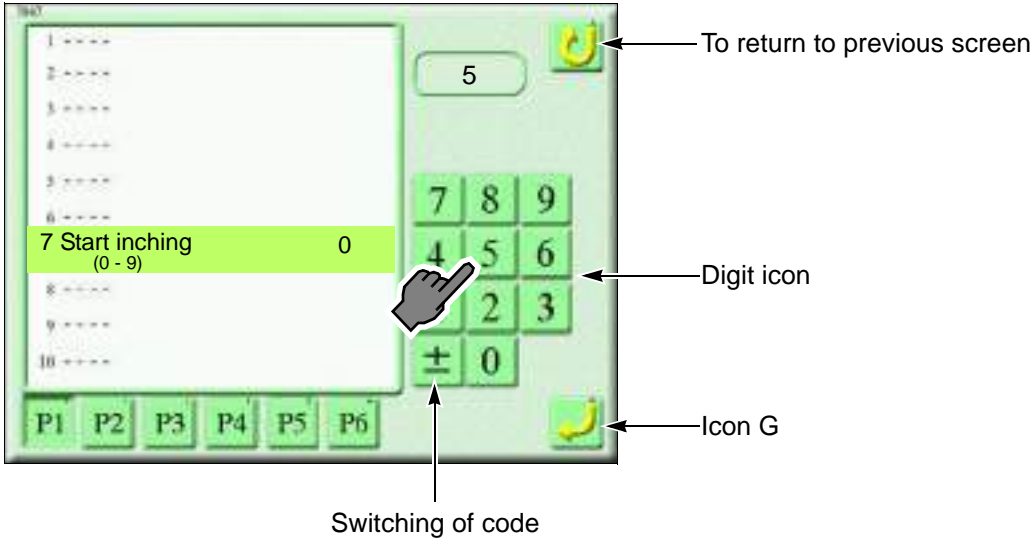

2-2. To input character

When inputting the character, select the character icon, and press icon G.

Switching of large letter/small letter

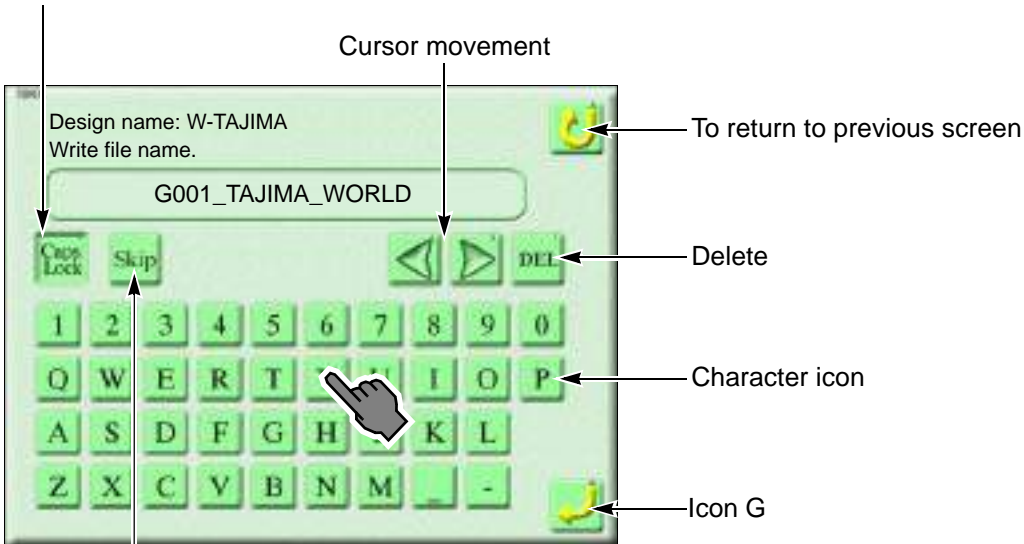

If there is a design with the same name in USB memory, it will be overwritten and saved.



If there is a design with the same name in USB memory, it will be saved as a different name.

Chapter 4

How to operate

1. To turn ON the power	36
2. Preparation before embroidering.....	36
3. To input design to machine memory.....	40
4. To decide embroidery design (Data Setting)	46
5. To decide embroidery mode	48
6. Items to check	50
7. To move frame to start position	52
8. To start embroidering.....	55

1. To turn ON the power

! CAUTION

⊘ Do not turn ON the machine power with the USB memory connected to the operation panel. The system sometimes may not start up.

When the power starts up, after the screen of software version displays, the main screen will appear. From this screen, setting or operation will be started.

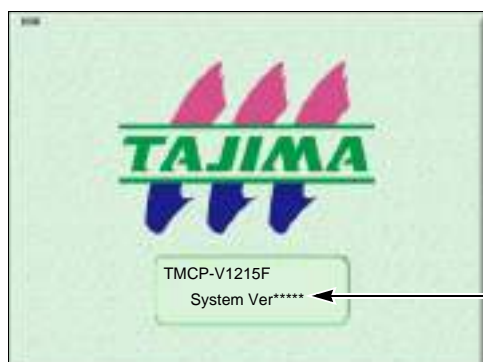

Screen of software version

Software version of panel card



Main screen

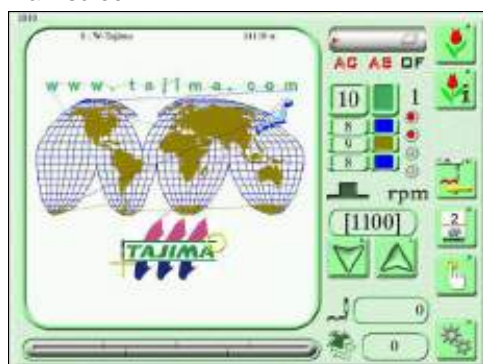

2. Preparation before embroidering

2-1. To set fabric

To make embroidery results beautiful or to perform efficient works by reducing the thread breakage, it is important to stretch the fabric correctly on the embroidery frame. Fix fully stretched fabric without any wrinkle.

2-2. Thread passing

If the thread does not pass to each section correctly, it could cause trouble such as the deterioration of embroidery or the thread breakage, etc. Pass the thread correctly referring to the figure below.

- (1) Place the thread cone on the thread stand blade.
- (2) Pass the thread through the thread course.

Play a video.



To play the video, Adobe Flash Player is necessary. Press the play button as shown left, and follow the displayed screen to install Adobe Flash Player.

To close the video, scroll down to the next page.

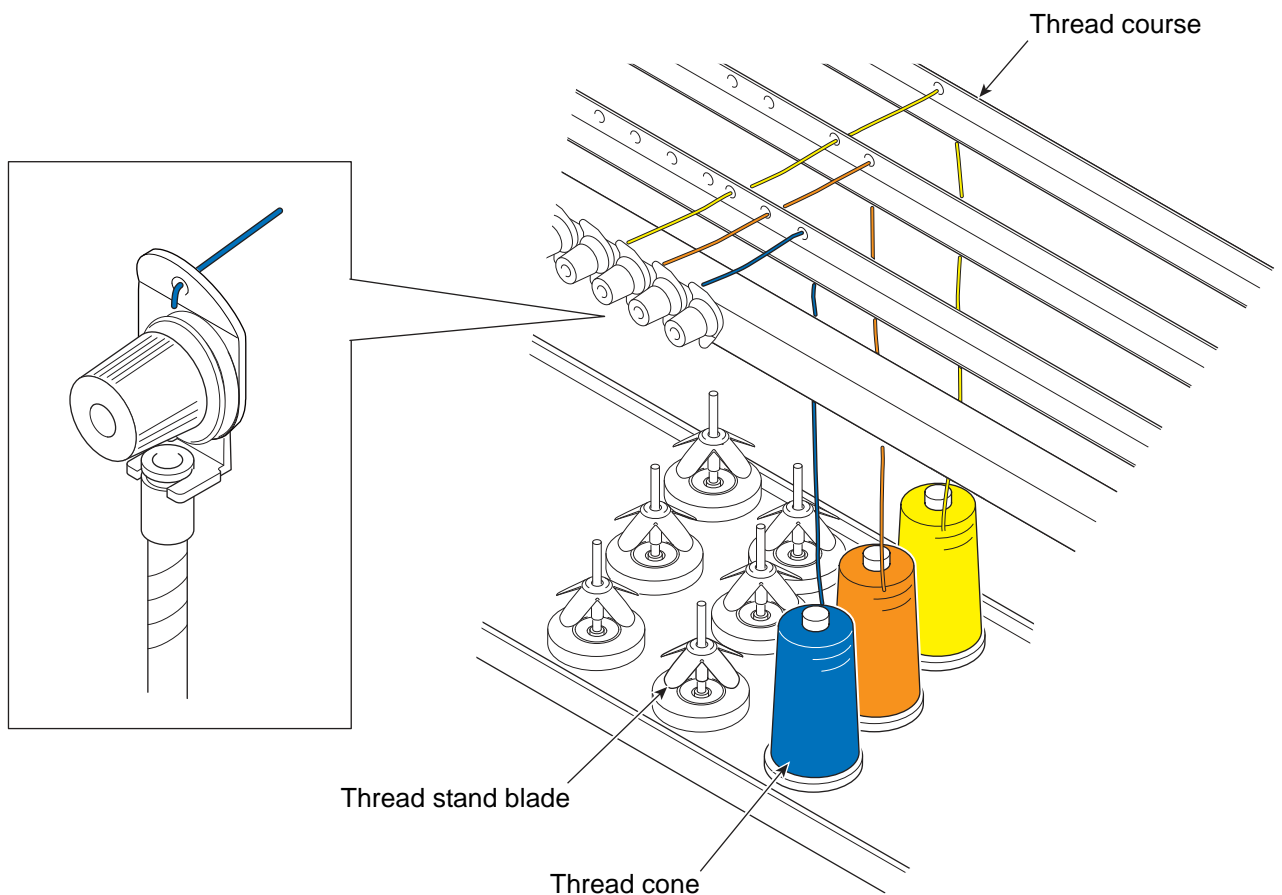

- (3) Put the thread into the groove of the tension stud. (Indicated by an arrow)
- (4) To perform threading through the spiral tube, use the threader (accessory).

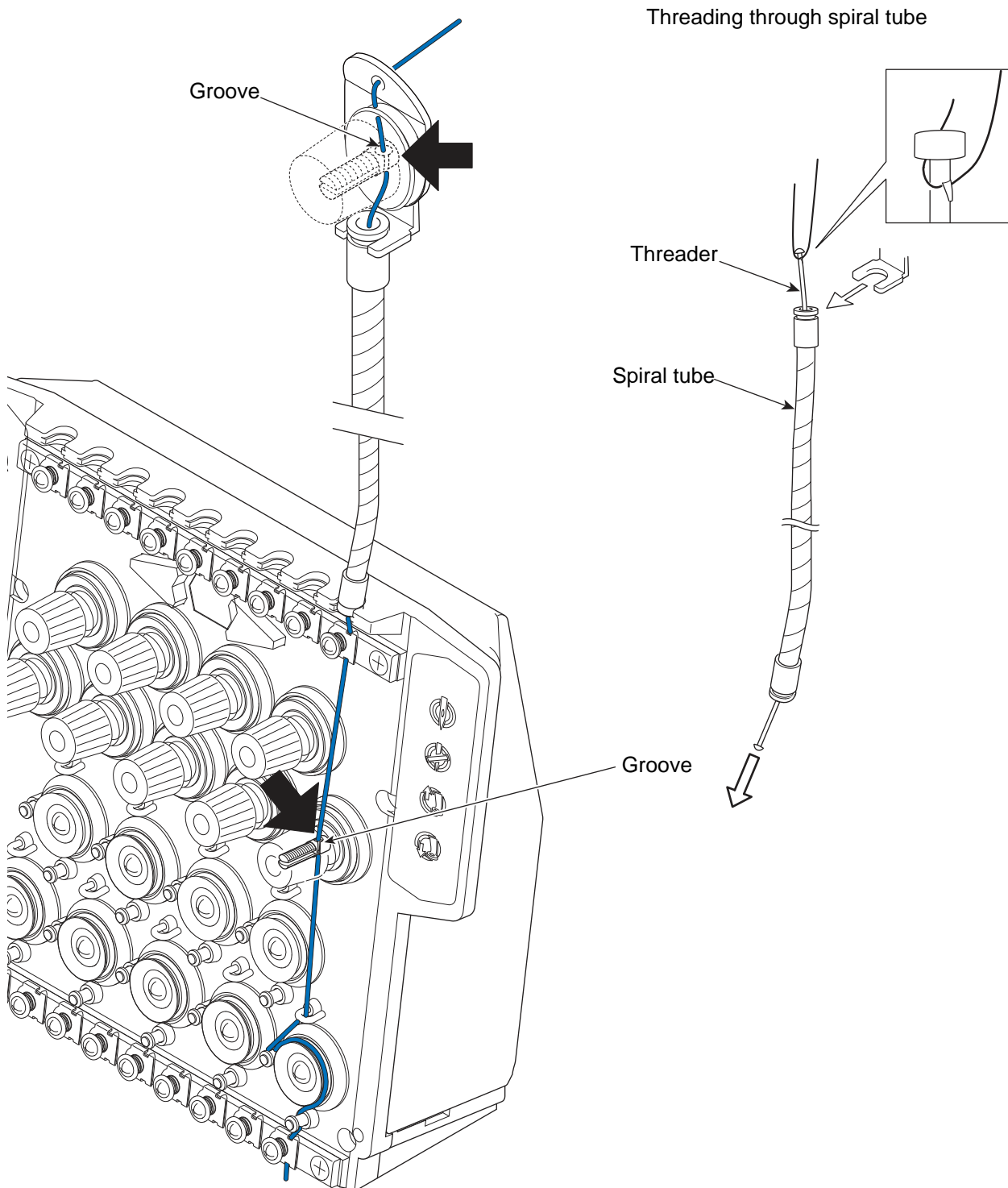

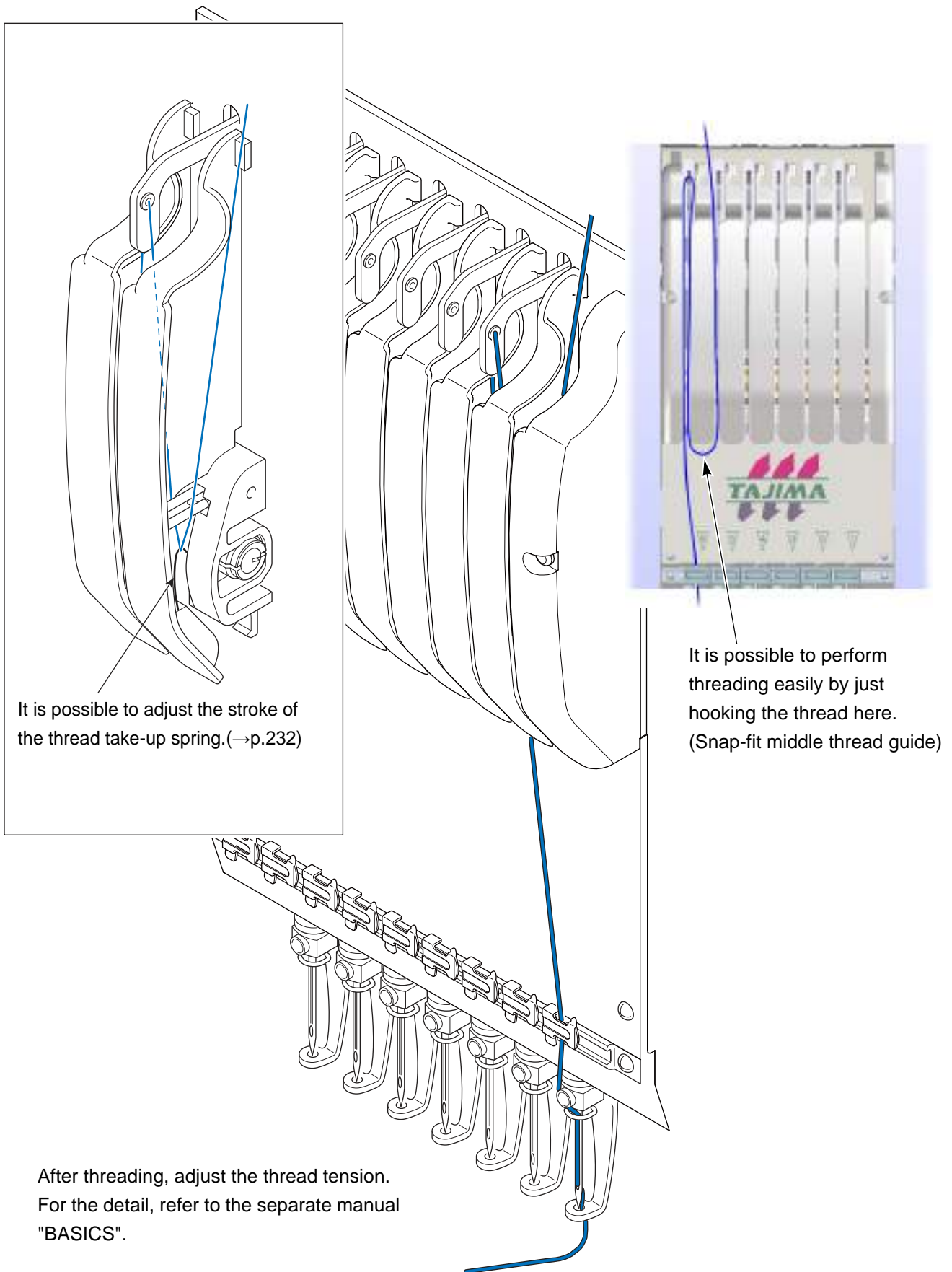

It is possible to adjust the stroke of the thread take-up spring. (→p.232)

It is possible to perform threading easily by just hooking the thread here. (Snap-fit middle thread guide)

After threading, adjust the thread tension. For the detail, refer to the separate manual "BASICS".

3. To input design to machine memory

The machine memory can register up to 650 designs at the maximum. (Up to 2,000,000 stitches for one design)

Main: 200 designs

Group 1 to 5: 90 designs each

3-1. To input design in USB memory to machine memory

Hereafter, icons are referred as icon A and icon B derived from each alphabet positioned at upper right of each icon.

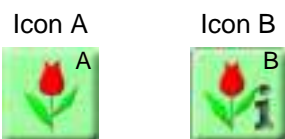

It is possible to register the condition data (Color change sequence, Start position) included in the design in USB memory into the machine memory(→p.167)

This enables to omit the setting of the color change sequence and the start position.

[How to operate]

Example: Select two designs and input to "Main" of the machine memory.

(1) To set USB memory

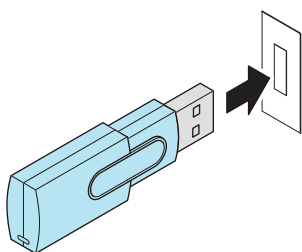

(2) Icon A

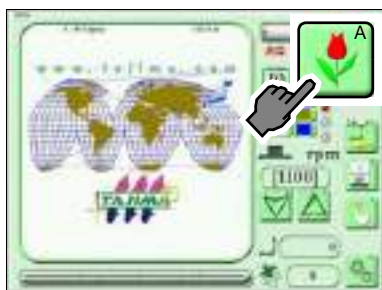

(3) Icon B



(4) 1st design

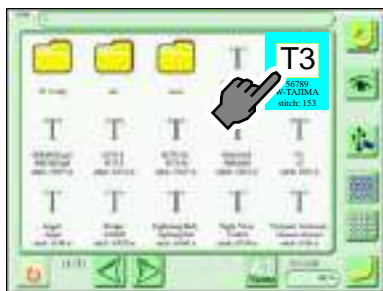

Regarding the screen 3100 of the left figure, refer to the detail page.(→p.29)



If this icon is pressed, all designs will be selected.



If this icon is pressed, selecting the design will be

(5) 2nd design

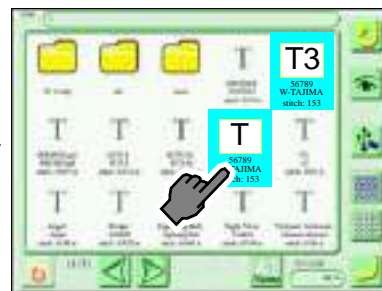

(6) To set

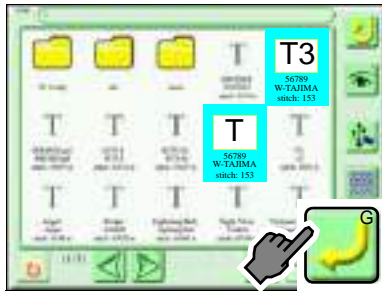

When the numbers of designs exceed the machine memory capacity or the machine memory capacity is not enough, the code No. 2BA will be displayed.

(7) Main

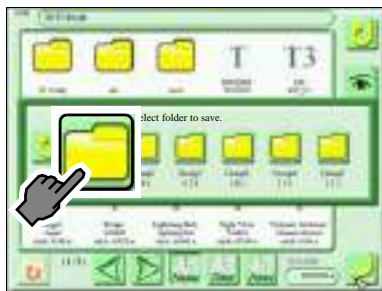

(8) Screen 2000 (Completed)



When embroidering this design continuously, proceed to the following operation.

"To decide embroidery design (Data Setting)"(→p.46)

3-2. To input design in personal computer to machine memory

Software sold separately (DG/ML by Pulse) is necessary to perform this operation. The below operating example is inputting method of data by "DG/ML by Pulse".

[How to operate]

Example: Select two designs and input to "Main" of the machine memory.

- (1)** Turn OFF the power of the personal computer and the machine.
- (2)** Connect the personal computer to the machine with LAN cable.

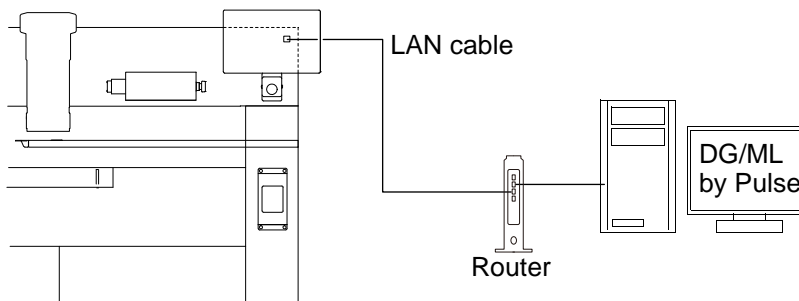

(3) Turn ON the power of the personal computer, and start up DG/ML by Pulse.

(4) Turn ON the machine power, and set "1 Network" to "DG/ML[V1]".(→p.173)

(5) Icon A

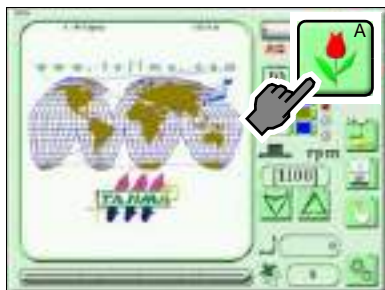

(6) Icon C

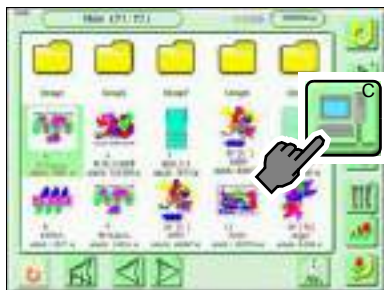

For DG/ML by Pulse, the icons below will appear.

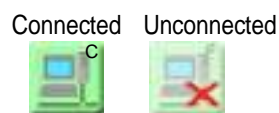

(7) 1st design



(8) 2nd design

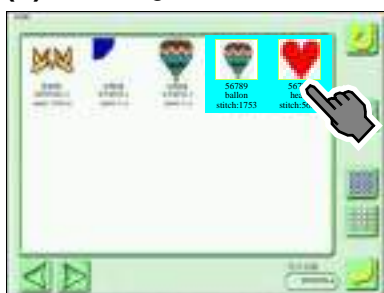

To search the design from file name, after selecting icon D, input file name.

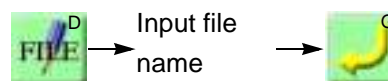

(9) To set

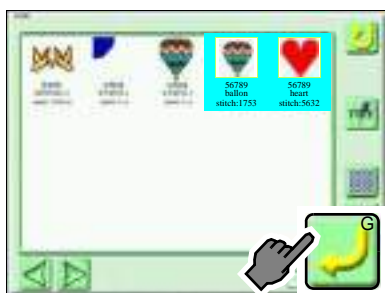

(10) Main



(11) Screen 2000



Registration is completed. When embroidering this design continuously, proceed to the following operation.

"To decide embroidery design (Data Setting)"(→p.46)

3-3. To input design in personal computer to machine memory (Using a bar code reader)

Select the design (saved in DG/ML by Pulse) by the bar code reader and input it to the machine memory. Regarding the bar code reader, prepare a commercial item. To perform this operation, software sold separately (DG/ML by Pulse) is necessary.

[How to operate]

- (1)** Turn OFF the power of the personal computer and the machine.
- (2)** Connect the personal computer to the machine with LAN cable.
- (3)** Turn ON the power of the personal computer, and start up DG/ML by Pulse.
- (4)** Turn ON the machine power, and set "1 Network" to "DG/ML[V1]".(→p.173)
- (5)** Connect the bar code reader to the USB port of the operation panel.

Bar code reader

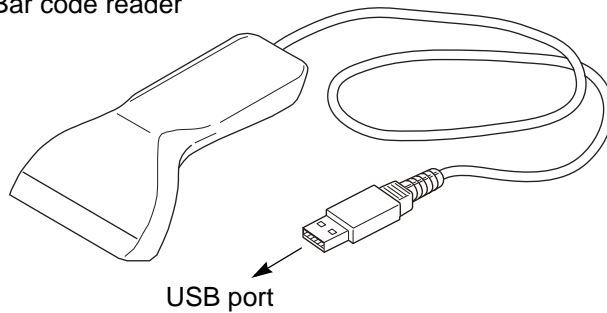

- (6)** Set to the main screen.



(7) Read the bar code by using the bar code reader.

Bar codes can be printed by using the print function of DG/ML by Pulse.

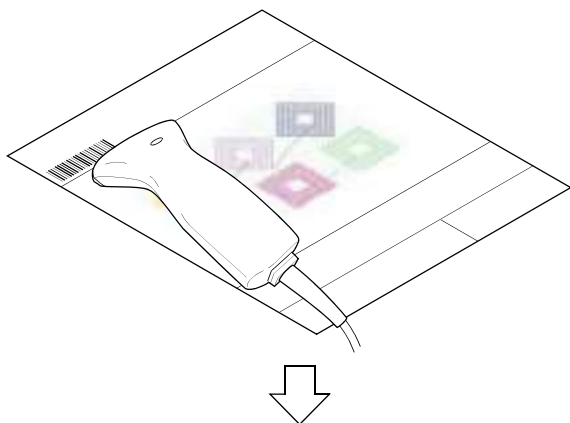

The message will be transmitted from the personal computer to the machine, and it will be displayed on the operation panel.



The bar code can be read also from the following screen.

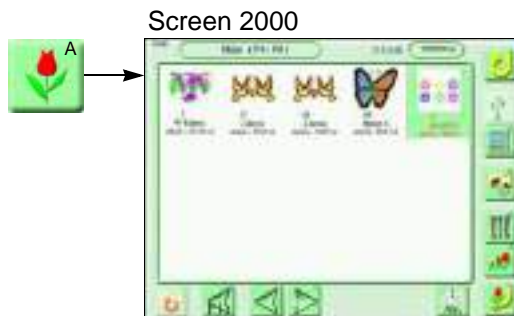

In addition, bar codes can be read also from the following screens.

Screen 4100, Screen 4150

If the bar code of the design to be embroidered next is read during machine operation, the pre-read design will be set at the end of the current embroidery design and then a yellow bar will be displayed.
(Pre-reading of the next design)

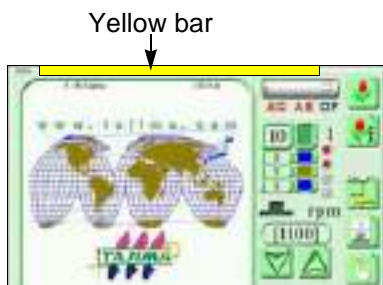

When performing the following operation, the yellow bar will disappear.

- When performing panel operation
- When the machine is started/stopped
- When the power is turned OFF and ON, etc.

The pre-read design requires the following conditions.

- The design which can be performed pre-reading is one design only.
- When bar codes are read plural times during operation, the design read latest will be selected.
- When suspending to embroider a design during operation and setting the data of another design, the pre-read design will be deleted.
- To suspend embroidering some design during operation and perform the data setting of the pre-read design, read the bar code again.

4. To decide embroidery design (Data Setting)



CAUTION

 When performing this operation, do not put your hands, etc. on the table. Moving the frame could injure you.

[How to operate]

Example: Select one design from designs saved in the machine memory.

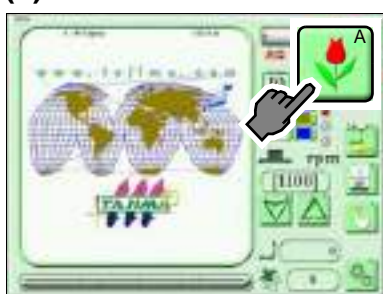
(1) Icon A



(2) Embroidery design



(3) To set



(4) Yes (Completed)

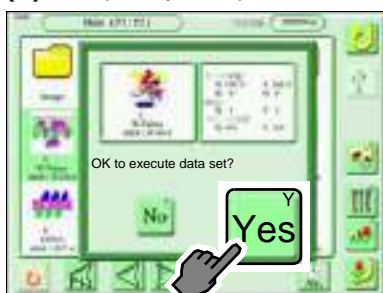

When "Start position" or "Offset position" is set in an embroidery design, the following display will appear. If "Yes" is pressed, the frame will move.

For "Start position" and "Offset Position", refer to the detail page. (→p.193)

(5) Yes (Completed)

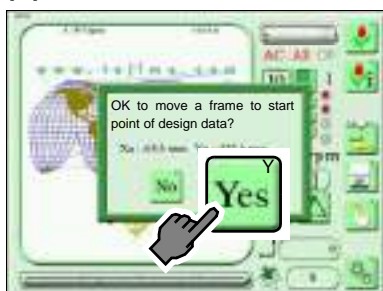

The screen described left shows the message when the start position is set. When the offset position is set, the message below will be displayed.

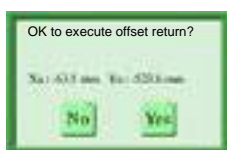

When some message is written for the design (***.TCF), the following screen will be displayed. To write some message into the design (***.TCF), DG15 by Pulse or later version is necessary.

Display after data set

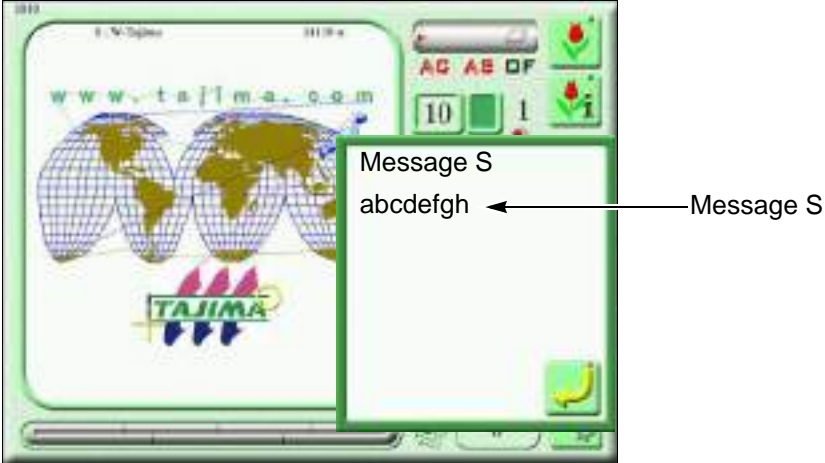

Display after completion of embroidery

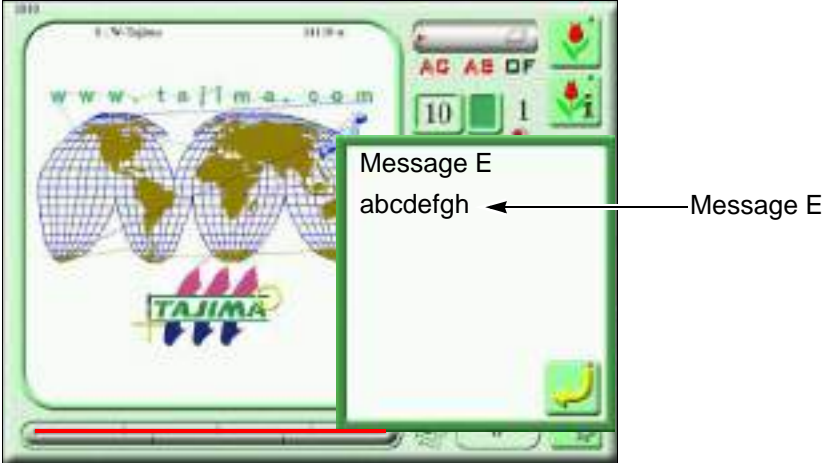

5. To decide embroidery mode

5-1. To perform color change and start operation automatically

According to usage order of needle bars, set "To perform" / "Not to perform" Color Change automatically. To sew with single color irrespective of using order, set "Auto Color Change" to "No". If "No" is selected at "Auto Color Change", it is not possible to set "Auto start" or "Auto start after auto data set".

[How to operate]

Example: Perform Auto color change, and Auto start.

(1) Icon G

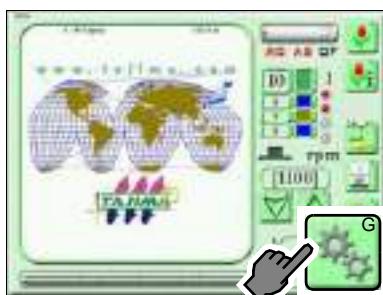

(2) Auto Color Change, Yes

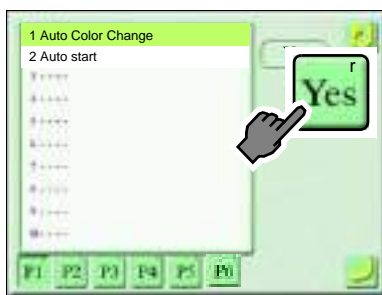

(3) To set

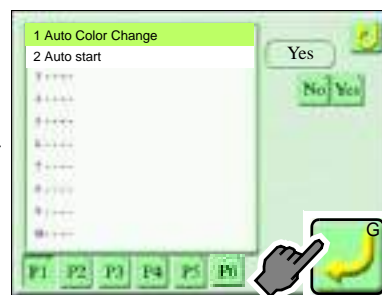

(4) Auto Start

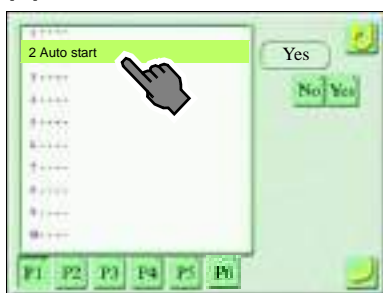

(5) Yes

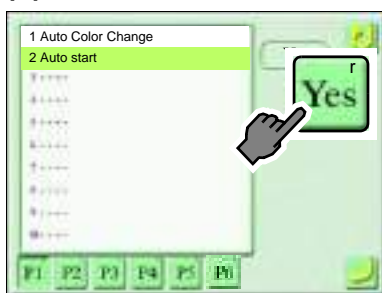

(6) To set (Completed)

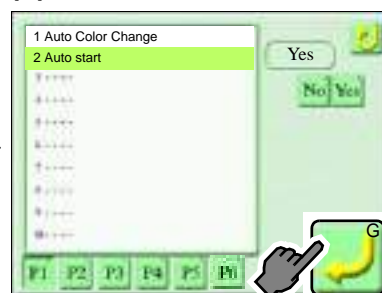

5-2. To decide needle bar order

This setting is effective only when Auto Color Change is set to "Yes". (→p.143)

This setting is unnecessary when the order of needle bars to use is already included as the condition data in the design to be embroidered from now.

[How to operate]

Example: Set step 1 to needle bar No.4 and step 2 to needle bar No.6.

(1) Icon A

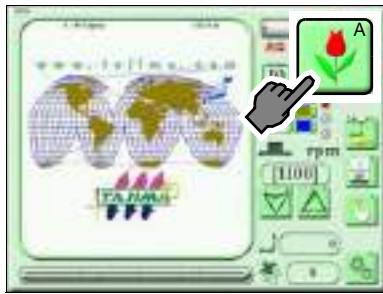

(2) Design

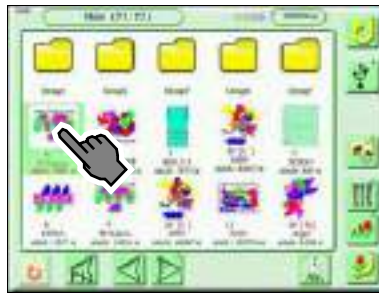

(3) Icon E

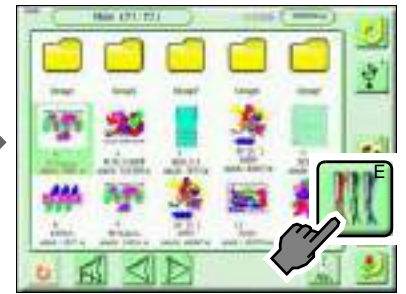

(4) Step 1, needle No.4

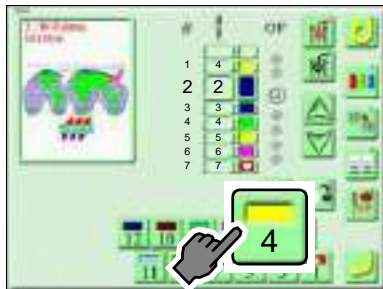

Regarding the screen 2010 of the left figure, refer to the detail page. (→p.32)

(5) Step 2, needle No. 6

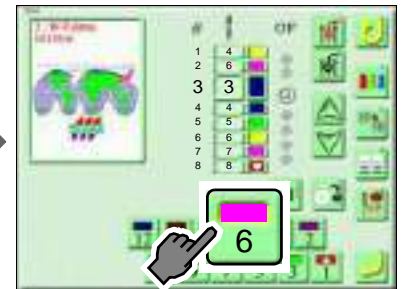

(6) To set (Completed)

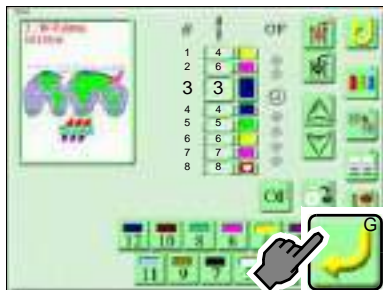

[How to operate]

Example: Set step 3 to needle bar No.6.

(1) Step 3

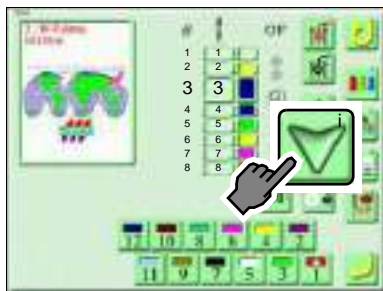

(2) Needle bar No. 6

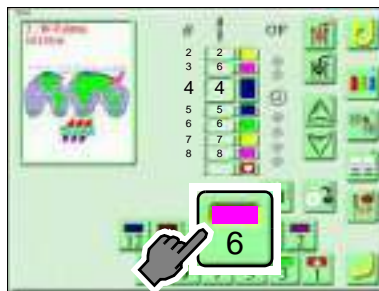

(3) To set (Completed)

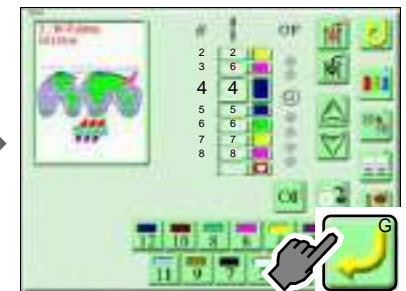

6. Items to check

6-1. To check size of design and setting contents

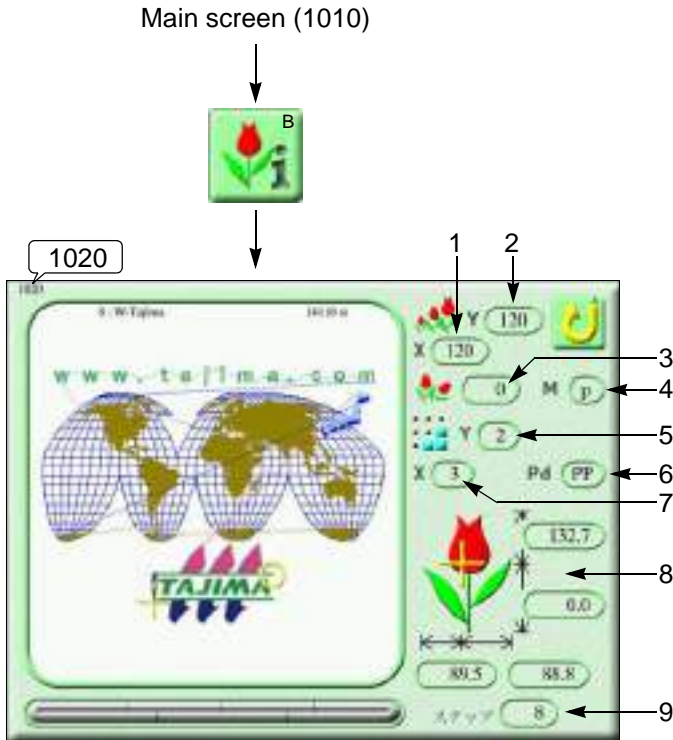

1. Scale ratio of design (Horizontal)
2. Scale ratio of design (Vertical)
3. Rotating angle of design
4. Reverse of design
P: Not to perform Q: To perform
5. Number of repeats of design (Vertical)
6. Repeat method
7. Number of repeats of design (Horizontal)
8. Size of design (mm)
The size after scaling up/down will be displayed on the base of the start position.

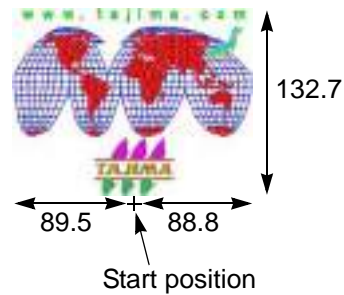

When some message is written for the design (***.TCF), the following screen will be displayed. To write some message into the design (***.TCF), DG15 by Pulse or later version is necessary.

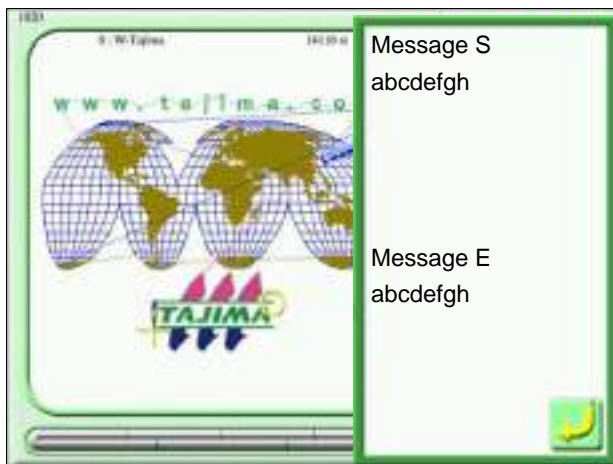

9. Number of steps of design

6-2. To check the heads to be used

Check if the right LED of the head to embroider lights up in green. When the right LED of the head to embroider is unlit, press A switch. The right LED at the head will lights up in green.

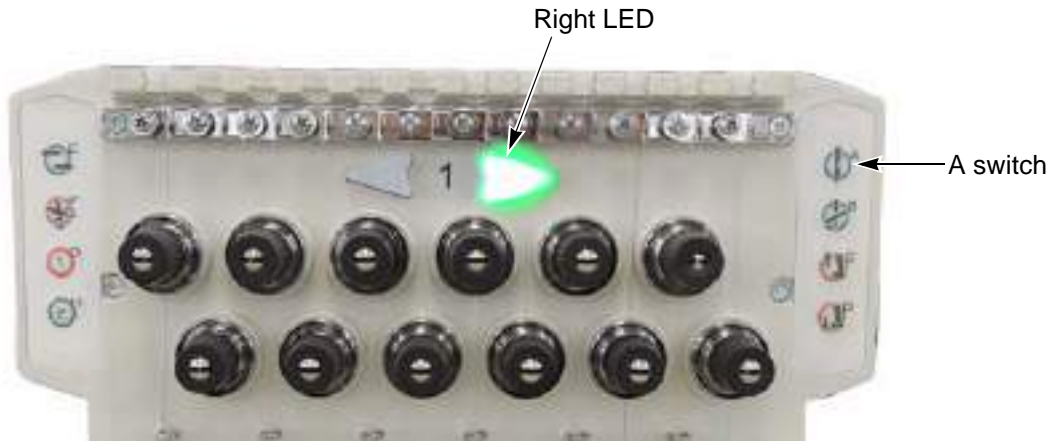

6-3. To decide maximum speed

Maximum speed means the maximum value of the embroidery speed. The embroidery speed will increase/decrease automatically according to the stitch length of the design during the operation.

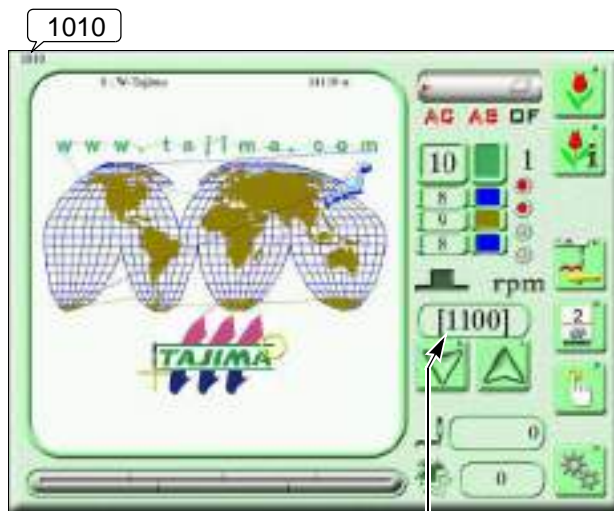

Maximum speed

Maximum speed

The maximum speed will be displayed by [] during stop of the machine.

To change the maximum speed during stop or operating of the machine, press the following icons.

To lower To raise

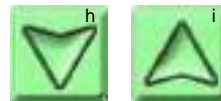

The value will be forwarded faster by pressing the key longer.

7. To move frame to start position

7-1. To move frame

Perform this operation when moving the frame to the start position manually.

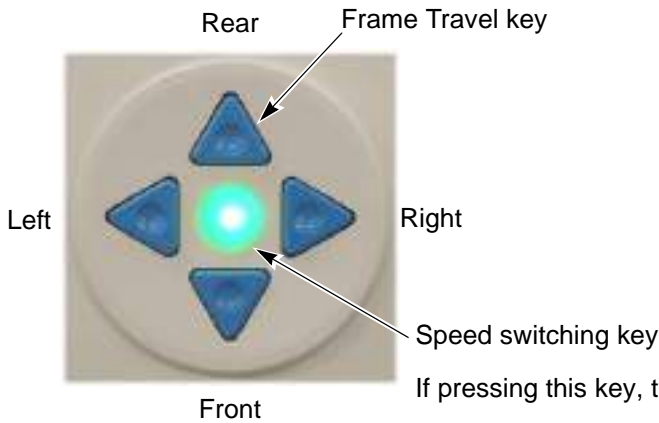

If pressing this key, the frame travel speed will change.

Low speed: Key will be unlit.

Middle speed: Key will be lit.

High speed:

Press the frame travel key while pressing the speed switching key.

The current frame position can be checked on the screen 6030.

Main screen (1010)



Frame position

6030



Selecting coordinates icon will change the indication.

Xa +85.4 Ya +120.5	↔	Xr -65.8 Yr +72.5
Coordinates based on absolute origin of frame		Coordinates based on the start position of the design which data is set

7-2. To check if design fits in embroidery space (Tracing)

It is possible to check the size of the design by moving the frame along the design before embroidery.
(→p.196)

The position where tracing was executed will be the start position.



CAUTION

 When performing this operation, do not put your hands, etc. on the table. Moving the frame could injure you.

[How to operate]

Example: Execute tracing by high speed frame travel.

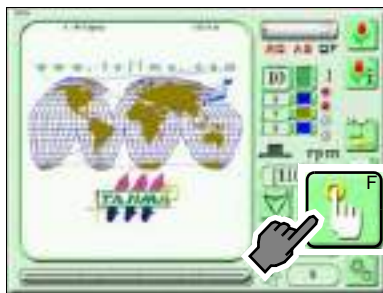
(1) Icon F



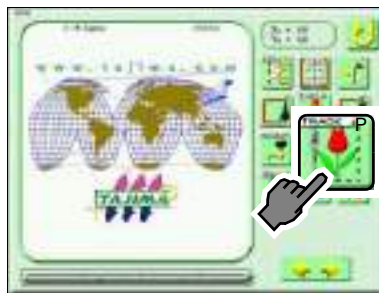

(2) Icon P



(3) High speed frame travel
(Completed)



-  3 ← Current needle bar No.
-  High speed frame travel
-  Low speed frame travel

To interrupt working, press the stop switch. To start again, follow the operating screen.

When the start position is correct, the frame will move to the direction indicated by arrows from the start position and will stop after finishing Trace.

(Fig. A)

When the start position is incorrect, the frame will stop during operation and the error No. 225 will appear. Decide the start position again. (Fig. B)

Fig. A

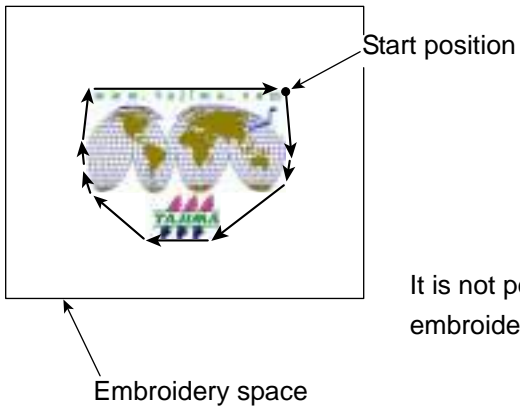
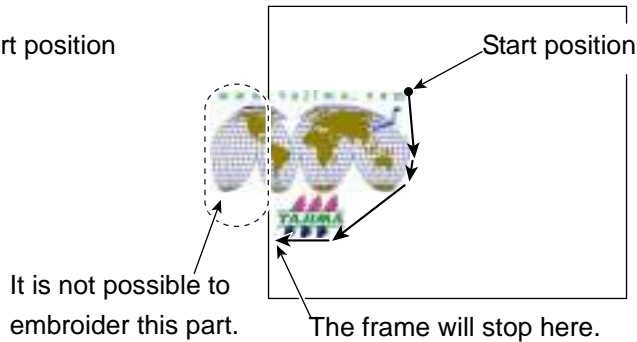



Fig. B



8. To start embroidering

CAUTION

 Before the start of the operation, pay enough attention to the surrounding safety. Moving the needle bar and/or the frame could injure you.

Bar switch



- (1) When starting the operation, move the bar switch to the right side.
- (2) To stop, move the bar switch to the left side.
- (3) To start slow operation from the state that the machine stops, move the bar to the right side and hold it at the position. Releasing it will change to normal operation.

8-1. Handling of thread breakage

The machine will stop automatically. Besides, the right LED at the head with thread breakage will switch to red (lit, or blinking). Code No.291 or No.293 indicating the thread breakage will be also displayed on the operation panel.(→p.214)

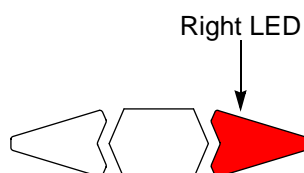

Condition of right LED

- Lit: The upper thread is broken.
- Blinking: The under thread is broken.

Restart the embroidery by the following procedure.

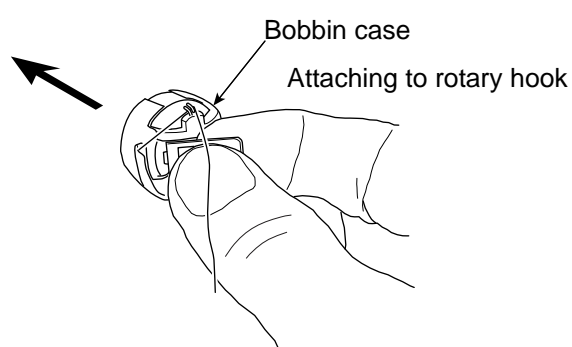
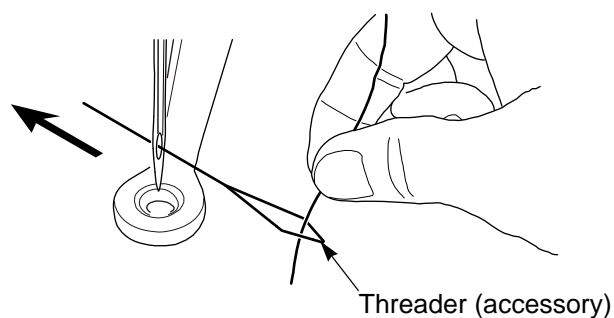

- (1) Thread the needle, or change the under thread (bobbin case).



- (2) Return the frame for several repair stitches.

When you start the machine, only the head with the thread breakage will start repair stitches from where the frame was returned.

When you want to add return stitches at the beginning of repair stitches, press A switch on the head with the thread breakage one time.

A switch	Color of LED lamp	
One time 	Thread is broken. Red 	State of return stitching Orange 

[Procedure from thread breakage to repair stitches]

- a. After thread breakage occurs, the frame will move some stitches and then stop.

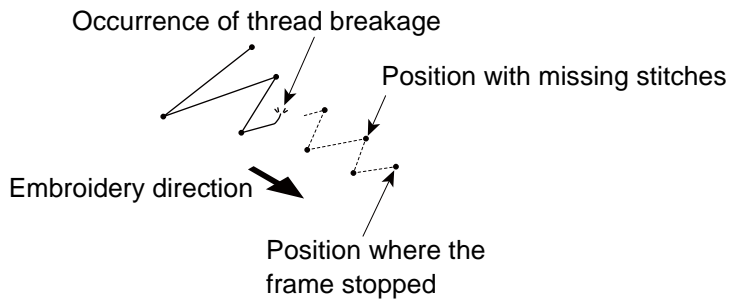

- b. Return the frame for some stitches.

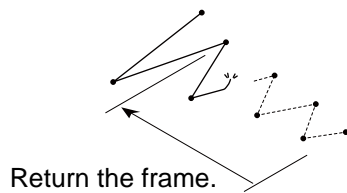

- c. When starting the machine, repair stitches will be performed only at the head with thread breakage.

After that, all heads start working and will continue embroidering.

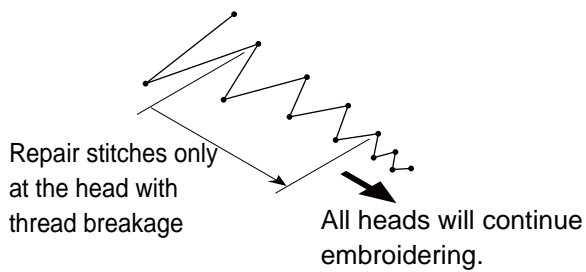

8-2. Completion of embroidery

Destination of the frame movement differs depending on setting of the machine.

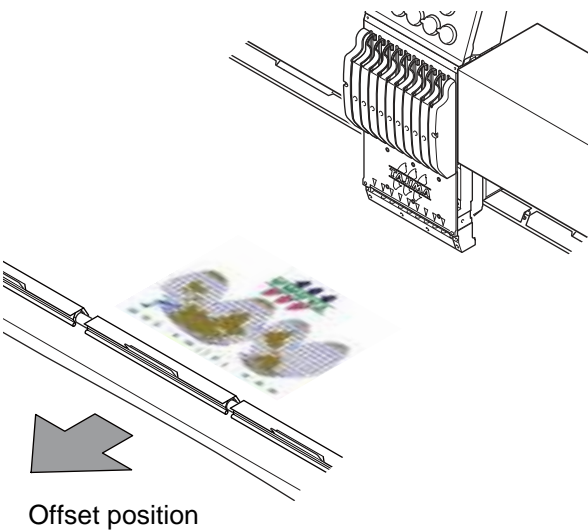
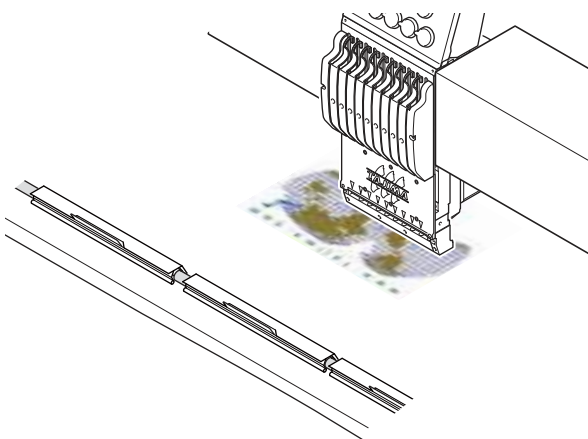
Setting of Automatic Offset	
Yes	No
<p>The frame will move to the offset position. (→p.98)</p> 	<p>The frame will not move. However, when Auto Origin Return has been set, the frame will move to the start position.</p> 

Chapter 5

Manual operation

1. To return frame, to advance frame	60
2. Thread trimming, color change.....	63
3. Frame Travel	65
4. Raising and lowering of needle bar	71
5. Various functions	73

1. To return frame, to advance frame

To return frame (Frame back):

The frame will be moved to the direction where stitches return with the needle bar stopped.
When thread breakage occurs, perform Frame Back by a few stitches automatically.(→p.147)

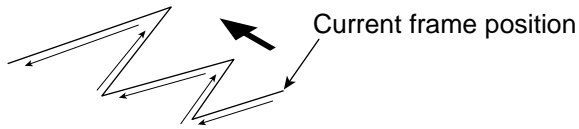

TO advance frame (Frame forward):

The frame will be moved to the direction where stitches advance with the needle bar stopped.

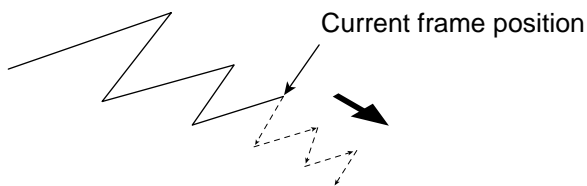

There are following three types of the frame travel by Frame Back, Frame Forward.

- Frame travel by 1-stitch unit
Perform by using the bar switch.(→p.13)
- Frame travel specifying number of stitches (Frame travel for number of stitches)
Execute on the operation panel.(→p.61)
- Frame travel by Stop code
Execute on the operation panel.(→p.62)

1-1. To switch "To return frame" , "To advance frame"

It is possible to switch also by using the direct command switch (E switch).(→p.24)

[How to operate]

Example: Switch from "To return frame" to "To advance frame".

(1) Icon D

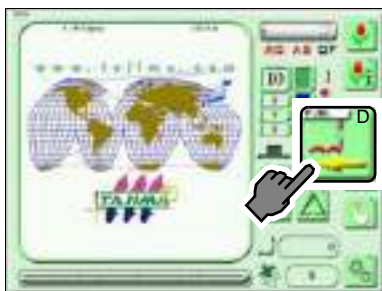

(2) Icon h (Completed)

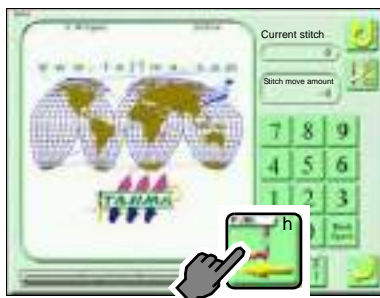

Every time pressing icon h will switch to FB (return the frame), FF (advance the frame).

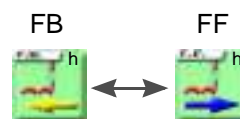

1-2. To perform "To return frame", "To advance frame"

Perform Frame Back or Frame Forward for all stitches being set together.

! CAUTION

 When performing this operation, do not put your hands, etc. on the table. Moving the frame could injure you.

[How to operate]

Example: Perform frame forward for all 500 stitches in one piece.

(1) Icon D

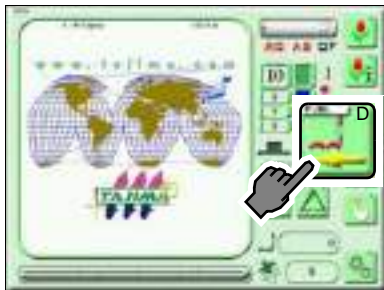

(2) Icon h



Every time pressing icon h will switch to FB (return the frame), FF (advance the frame).

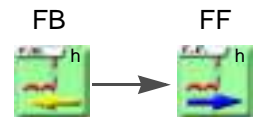

(3) To input 500

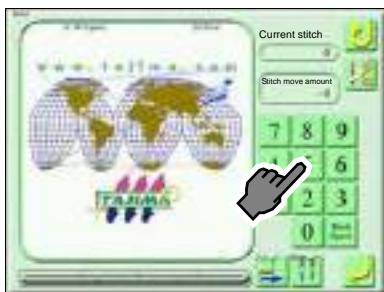

(4) To set (Completed)



1-3. To perform "To return frame", "To advance frame"

Perform Frame Back or Frame Forward by Stop code



CAUTION

 When performing this operation, do not put your hands, etc. on the table. Moving the frame could injure you.

[How to operate]

Example: Advance the frame for five times of color change codes.

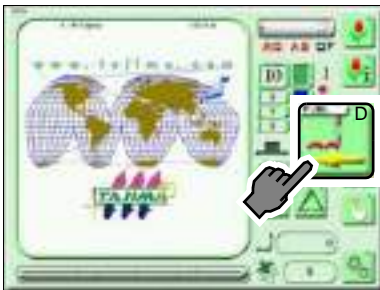
(1) Icon D



(2) Icon h

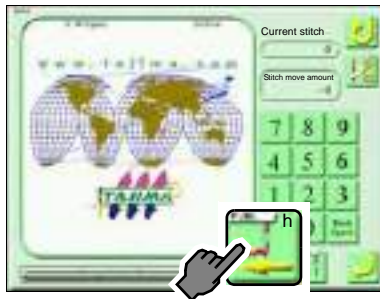

Every time pressing icon h will switch to FB (return the frame), FF (advance the frame).

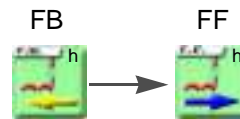

(3) Icon i

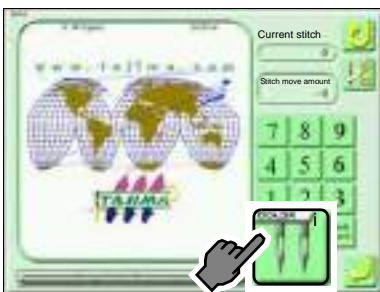

Every time selecting icon i will select the next color change code.

An example when selecting color change code five times

Color changes	Code
C + 5	+: To advance the frame -: To return the frame

The last color change code will be displayed as "E"

(4) To set (Completed)

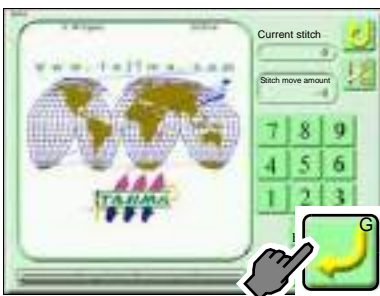

2. Thread trimming, color change

2-1. To trim thread

It is possible to trim thread also by using the direct command switch (F switch). (→p.24)

! CAUTION

⊘ When performing this operation, do not put your hands etc. near the needle or on the table. Moving needle bar or frame could injure you.

[How to operate]

Example: Trim upper/under thread.

(1) Icon F

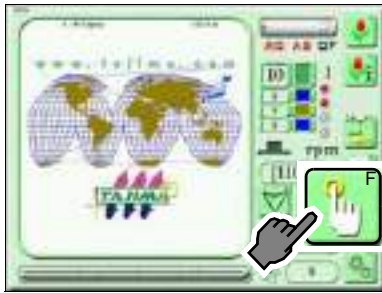

(2) Icon H

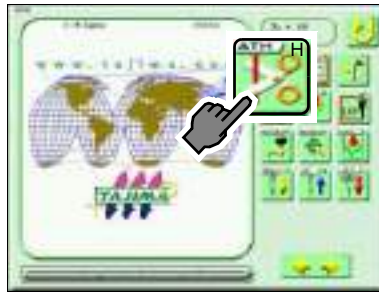

(3) Icon B (Completed)

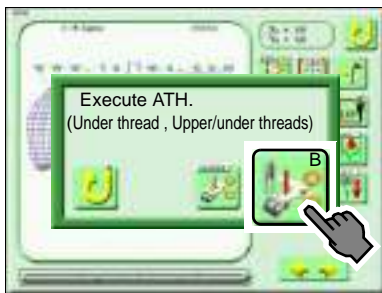

To trim under thread only



To trim upper/under threads

2-2. To change color

CAUTION

 When performing this operation, do not put your hands etc. around the needle bar case. Moving needle bar case could injure you.

[How to operate]

Example: Perform color change at 8th stitch.

(1) Icon E

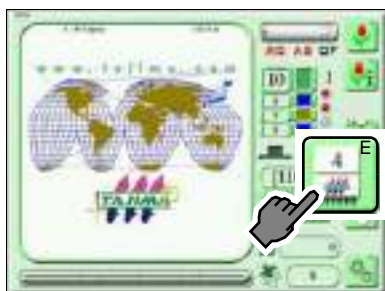

(2) Needle bar No. 8

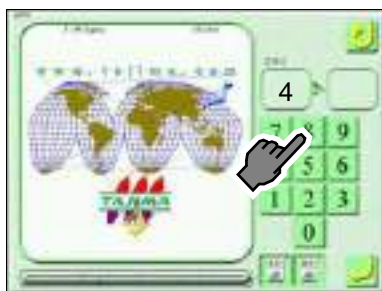

(3) To set (Completed)



3. Frame Travel

3-1. To move frame to registered position (Frame travel to optional position)

Move the frame to the position registered by parameter "39 Optional position".(→p.157)

! CAUTION

⊘ When performing this operation, do not put your hands, etc. on the table. Moving the frame could injure you.

[How to operate]

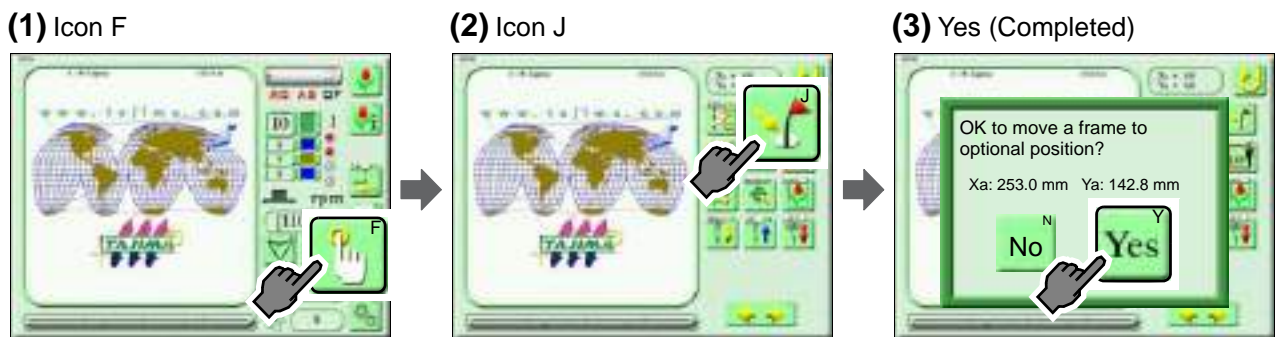

3-2. To return the moved frame to the previous position (Manual Offset)

It is possible to operate this function during embroidery only.

! CAUTION

⊘ When performing this operation, do not put your hands, etc. on the table. Moving the frame could injure you.

[How to operate]



3-3. To return frame to the start position (Start position return)

! CAUTION

⊘ When performing this operation, do not put your hands, etc. on the table. Moving the frame could injure you.

[How to operate]



3-4. To move frame to the registered position (Offset return)

It is possible to operate only when the offset position is registered.

! CAUTION

⊘ When performing this operation, do not put your hands, etc. on the table. Moving the frame could injure you.

[How to operate]

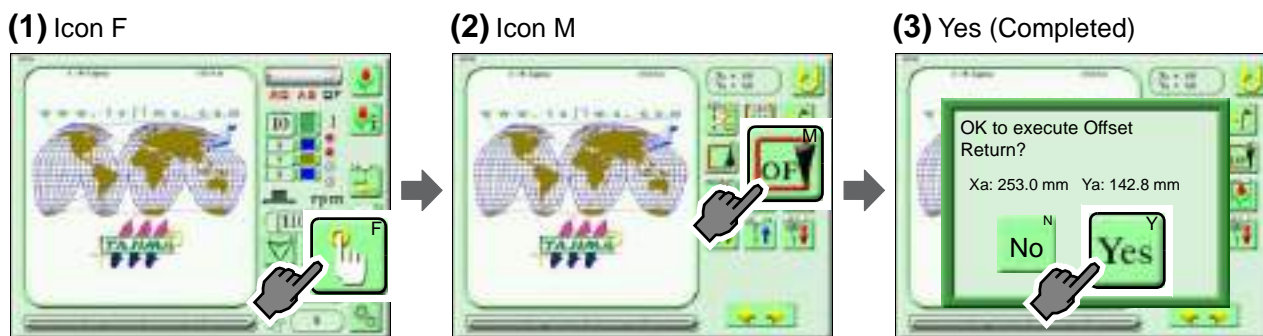

3-5. To move frame by inputting value (Input value for Frame Travel)

CAUTION

 When performing this operation, do not put your hands, etc. on the table. Moving the frame could injure you.

[Explanation of screen]

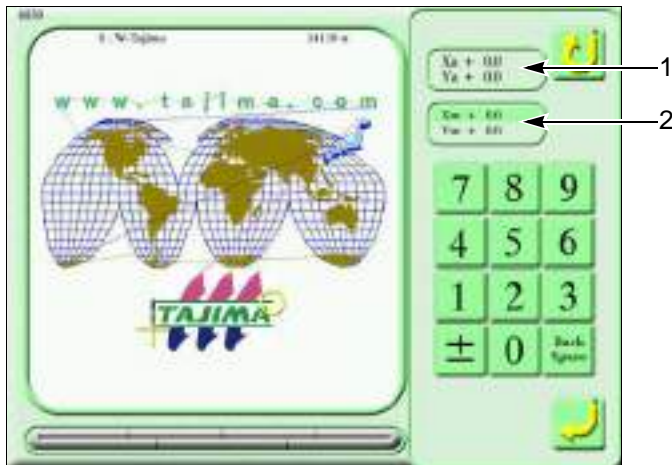

1. Current frame position

Selecting coordinates icon will change the indication.

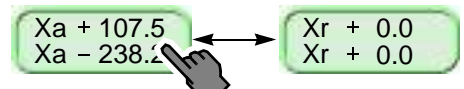

Coordinates based on absolute origin of frame

Coordinates based on the start position of the design which data is set

2. Frame Travel amount from current frame position

Horizontal

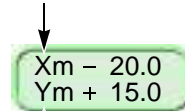

Vertical

[How to operate]

Move the frame by inputting the following value. The value is the moving amount from the current frame position.

X: +60.0 (mm), Y: -85.0 (mm)

(1) Icon F

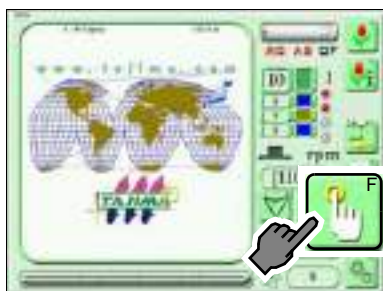

(2) Input value icon



(3) Xm + 0.0

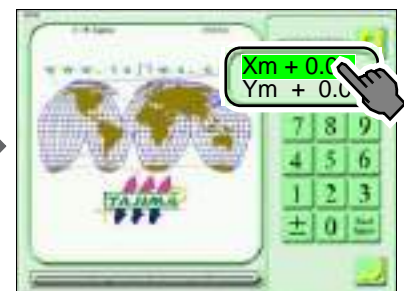

(4) + 60.0

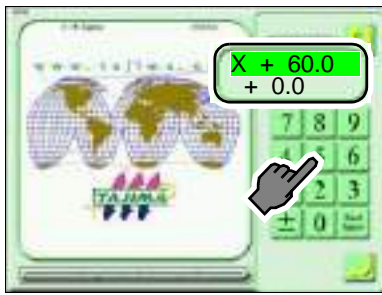

(5) Y + 0.0

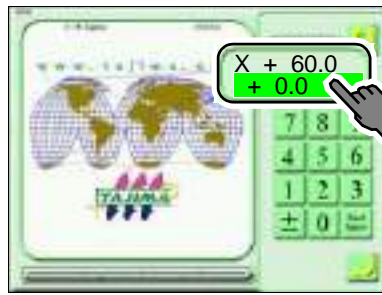

(6) Y - 85.0

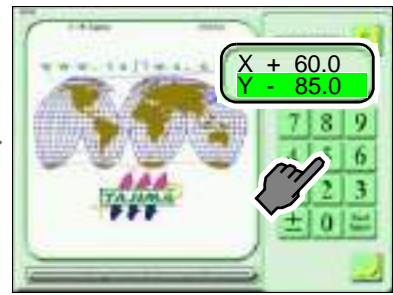

(7) To set (Completed)



3-6. To make machine memorize frame origin (Absolute origin search)

The frame origin is a reference point to calculate the frame position. (Xa:0.0, Ya:0.0)

Execute this function when moving the frame with the power turned OFF in changing frame etc. or when setting software frame limit.

If a frame origin is not correct, the following troubles will occur.

- The frame coordinates are not displayed correctly.
- The frame does not return to the interrupted position even after performing power resume, etc.

! CAUTION

⊘ When performing this operation, do not put your hands, etc. on the table. Moving the frame could injure you.

[How to operate]

(1) Icon F

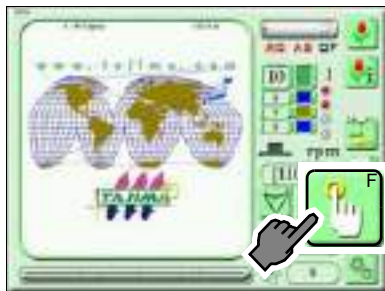

(2) Icon O

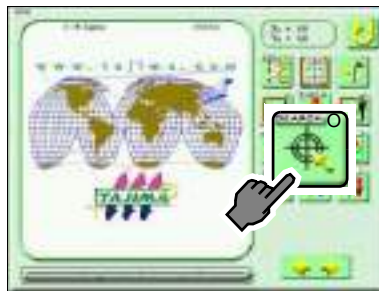

(3) Yes (Completed)

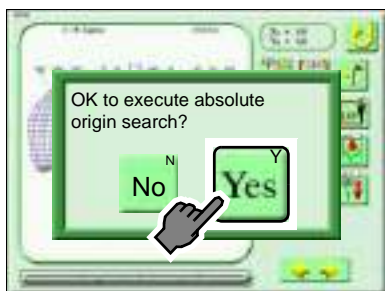

After Frame Travel, the frame will return to the previous position.

3-7. Resume operation when power is shut off (Power resume)

When the power is shut off by the emergency stop switch or the power failure etc., returning the frame to the previous position will prevent the design from displacing.(→p.12)

To perform origin return operation on the operation panel, follow the procedure below.

CAUTION

⊘ When performing this operation, do not put your hands, etc. on the table. Moving the frame could injure you.

[How to operate]

Example: Execute the power resume after thread trimming.

(1) Icon F

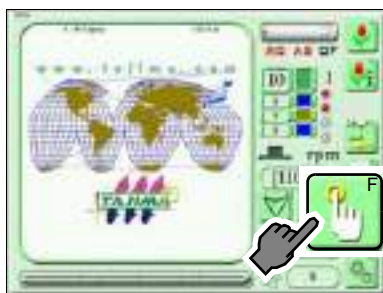

(2) Icon N



(3) To trim thread (Completed)

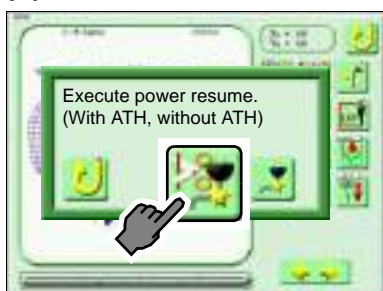

The frame will be moved after thread trimming.



Frame Travel will be performed without thread trimming.

(4) After frame travel, the frame may move forward by some stitches from the previous position. Check the frame position, and restart embroidery after returning the frame.

4. Raising and lowering of needle bar

4-1. To lower needle bar

Lower the needle bars selected now at all heads together. Use this function to make positioning of the frame before embroidering.

! CAUTION

⊘ When performing this operation, do not put your hands etc. near the needle or on the table. Moving up/down of the needle bar could injure you.

[How to operate]



4-2. To raise needle bar

! CAUTION

⊘ When performing this operation, do not put your hands etc. near the needle or on the table. Moving up/down of the needle bar could injure you.

[How to operate]

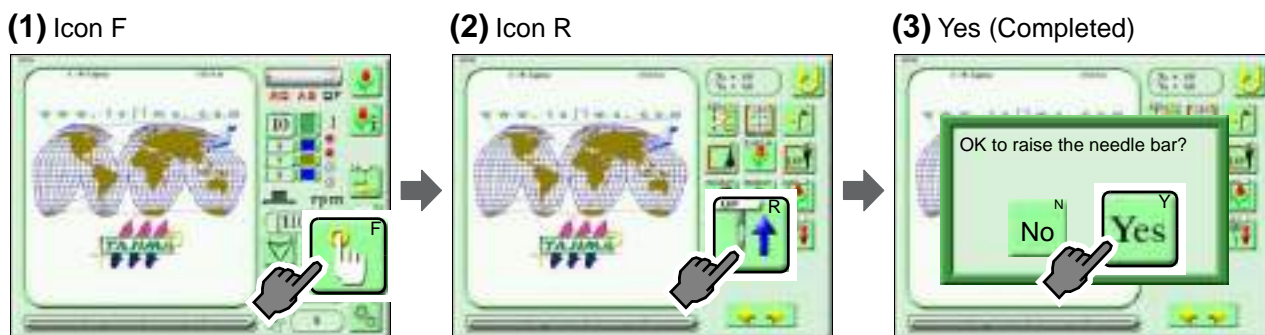

4-3. To lower needle bar to lower dead point

Lower the needle bars selected now to the lower dead points at all heads together. Performing this operation will cause the needle stuck in the fabric. Use this function to embroider consecutively on the long fabric.

CAUTION

 When performing this operation, do not put your hands etc. near the needle or on the machine table. Moving down of the needle bar could injure you.

[How to operate]

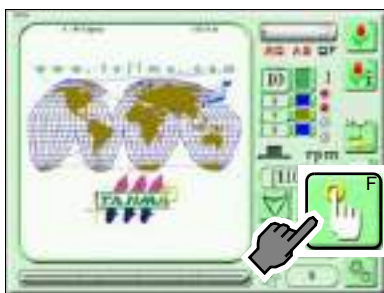
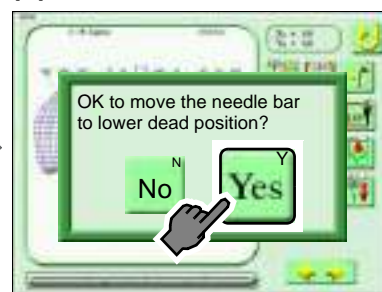
(1) Icon F**(2) Icon S****(3) Yes (Completed)**

5. Various functions

5-1. To turn ON/OFF the LED lamp

(1) Icon F

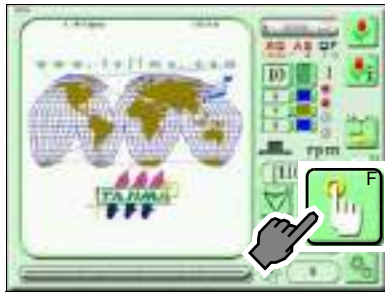

(2) Icon e



(3) Icon F (Completed)

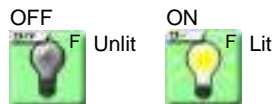

5-2. Machine log data Download

Get the operation logs and the communication records. This function is for analyzing cause of some trouble of the machine. When your distributor asks to get log datas, send datas to your distributor saving log data information in the USB memory by the following operation.

[How to operate]

Example: Save log data into the USB memory.

(1) To set USB memory

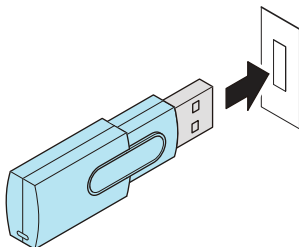

(2) Icon F

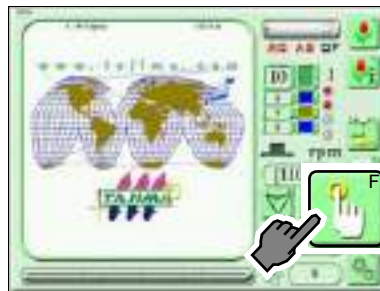

(3) Icon e



(4) Machine log

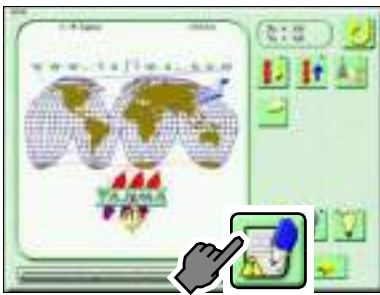

(5) Icon B

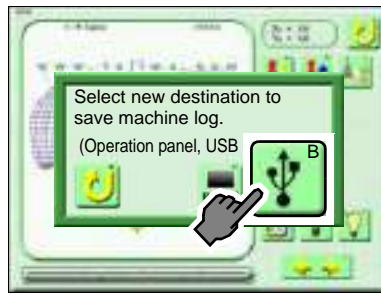

Save on operation panel^[1]



Save into USB memory^[2]

[1] Save the log data into a CF (Compact Flash Memory) inside of the operation panel for 50 times. The log data exceeding 50 times will be overwritten. It is not possible to take out any data from the CFast card.

[2] Save the log data saved in a CFast card and log data acquired this time into USB memory.

(6) Take out the USB memory.
(Completed)

5-3. To open the movable knife (ATH clean-up function)

Use this function to clean up around ATH (Automatic thread trimming device). (→p.222)

[How to operate]

(1) Icon F

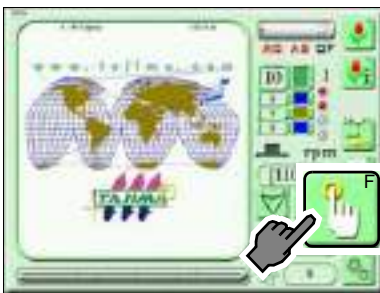

(2) Icon e

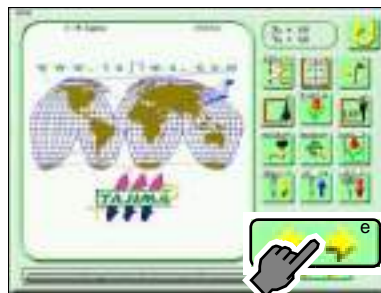

(3) Icon Y



(4) Icon u

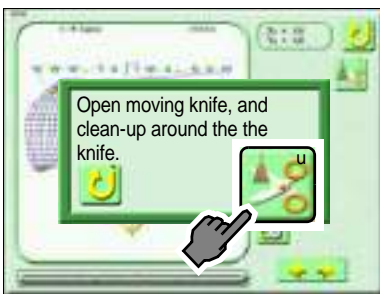

Since pressing icon u will open the moving knife, clean up around ATH. After cleaning, pressing the following icon will return the moving knife to the previous position.



Chapter 6

Delete, save and edit of design

1. To delete design	76
2. To save design, to change design name	79
3. To edit design	83
4. To copy, to divide and to combine design.....	91

1. To delete design

1-1. To delete design in machine memory by one design unit

[How to operate]

(1) Icon A

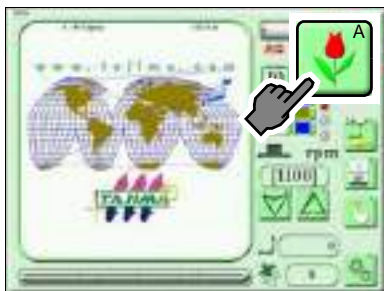

(2) Design to delete

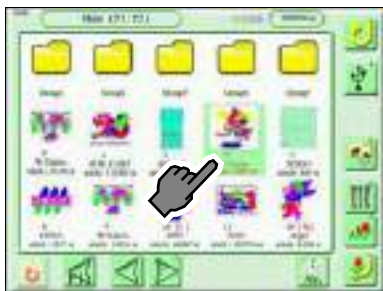

(3) Icon D



(4) To set

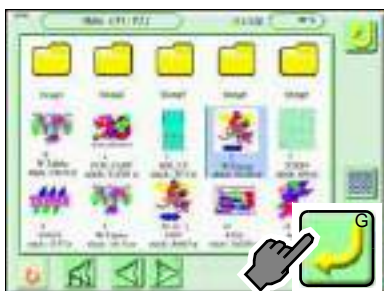

If this icon is pressed, all designs will be selected.



If this icon is pressed, selecting the design will be canceled.

(5) Icon I



(6) Yes (Completed)



When selecting the design of the set data, the following screen will appear.

(7) Yes (Completed)

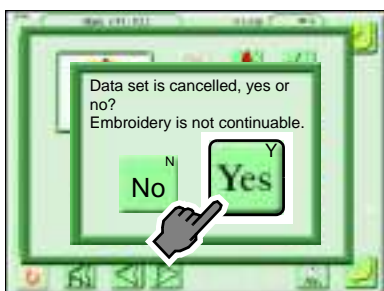

Pressing "Yes" will delete the design of which data is set.

1-2. To delete plural designs in machine memory

It is possible to delete designs without limit.

[How to operate]

Example: Delete two designs selected.

(1) Icon A

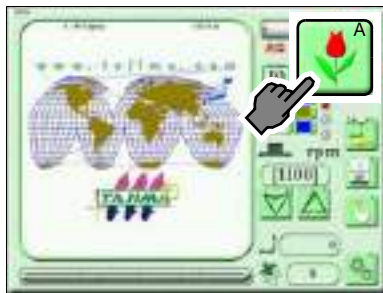

(2) 1st design

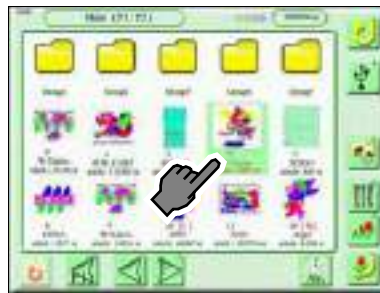

(3) Icon D

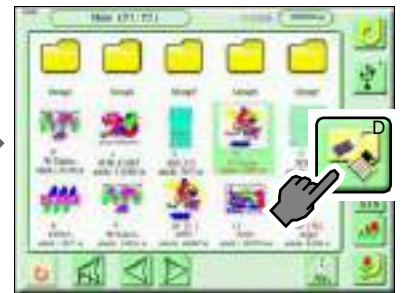

(4) 2nd design

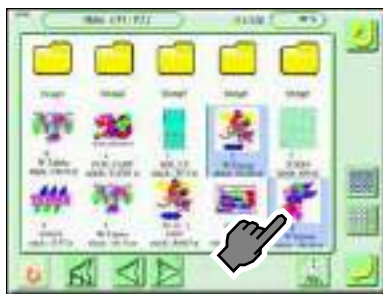

If this icon is pressed, all designs will be selected.



If this icon is pressed, selecting the design will be canceled.

(5) To set

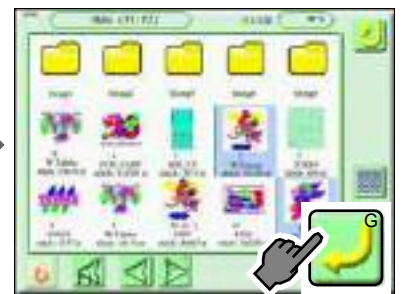

(6) Icon H



(7) Yes (Completed)

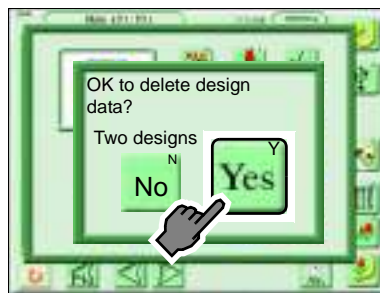

1-3. To delete design in USB memory

It is possible to delete designs without limit.

[How to operate]

Example: Select two designs, then delete them.

(1) To set USB memory

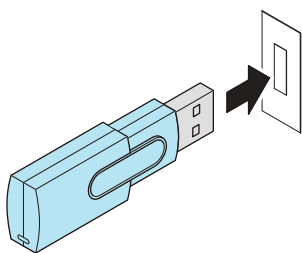

(2) Icon A

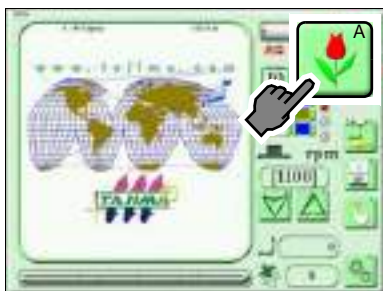

(3) Icon B



(4) 1st design

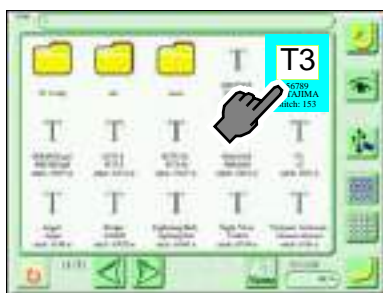

If this icon is pressed, all designs will be selected.



If this icon is pressed, selecting the design will be canceled.

(5) 2nd design

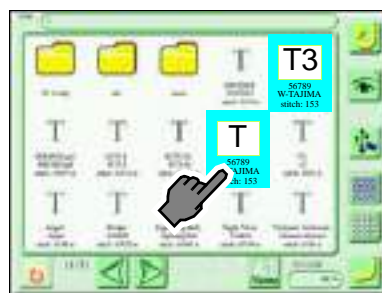

(6) Icon D

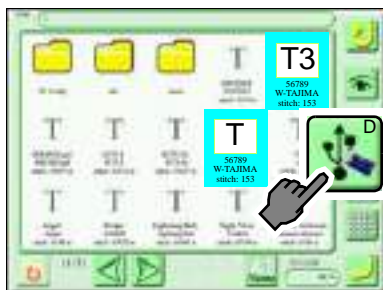

(7) Yes (Completed)

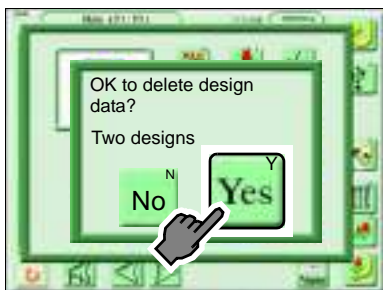

2. To save design, to change design name

2-1. To write design into a USB memory (Input of a password is necessary)

It is possible to write designs into USB memory without limit.

To use this function, it is necessary to set the functional limit level to "SEL" by inputting a password.
(→p.176)

[How to operate]

Example: Select two designs and write them into USB memory with the saving format "T3".

(1) Switch the screen to page P8, input the password and select "SEL".(→p.176)

(2) To set USB memory

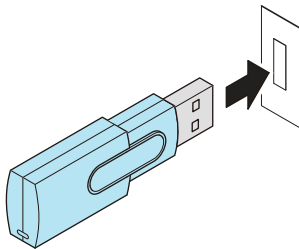

(3) Icon A

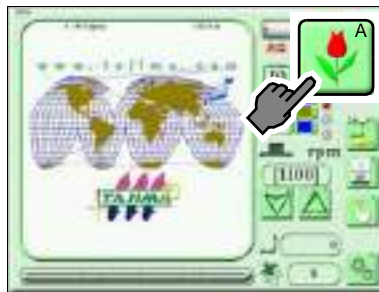

(4) 1st design

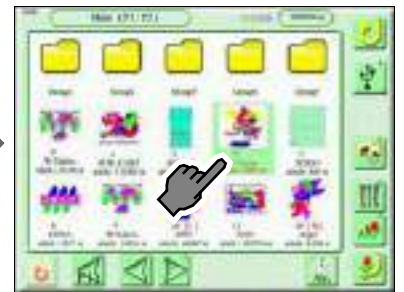

(5) Icon D

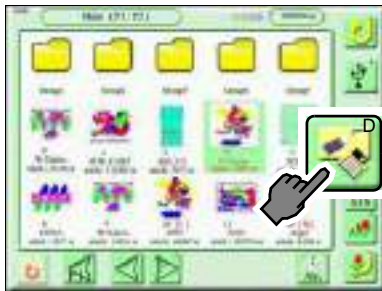

(6) 2nd design



If this icon is pressed, all designs will be selected.



If this icon is pressed, selecting the design will be canceled.

(7) To set



(8) Icon K



When the file name is not changed, proceed to the next operation after setting. (Procedure (11))

When changing the file name, follow the procedure below.

Change the file name of writing design 1. (Example: G0009)

(9) G0009^[1]

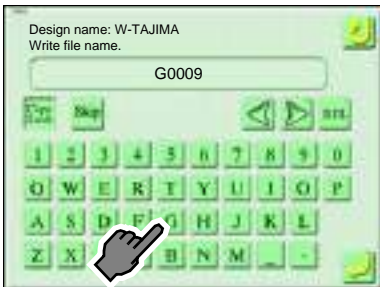

(10) To set

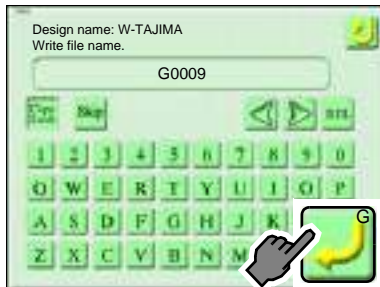

(11) T3^[2]

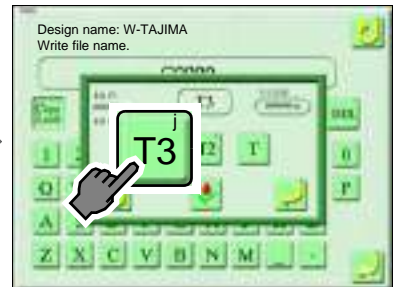

[1] Input the number or alphabet. (Up to 20 characters) Characters input here will become a file name on a personal computer.

G0009.TCF



File name on personal computer

[2] Select "T3" usually. When "T3" is selected, the message (S, E) also will be saved into USB memory.

(12) Saving format

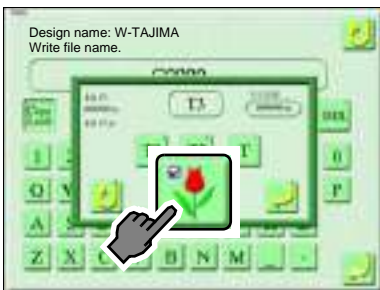

Save selected designs with each different saving mode.



Save all selected designs with the same saving format.

(13) To set

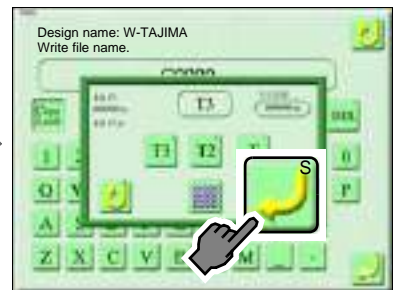

Change the file name of writing design 2 continuously. (Example: G0010)

(14) G0010



(15) To set (Completed)



2-2. To change saving place of design

Move the saving place of the design saved in the machine memory. It is possible to change the saving place of the design without limit.

[How to operate]

Example: Select two designs and move them to the saving place "Group 2" of the design.

(1) Icon A

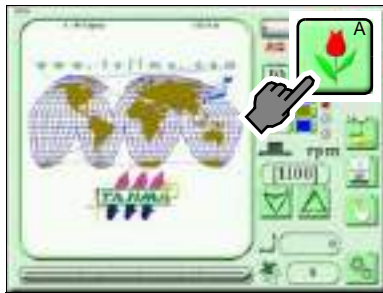

(2) 1st design

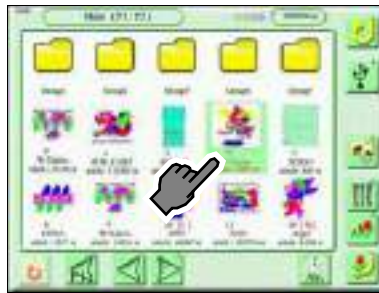

(3) Icon D



(4) 2nd design



If this icon is pressed, all designs will be selected.



If this icon is pressed, selecting the design will be canceled.

(5) To set



(6) Icon D



(7) Group 2 (Completed)

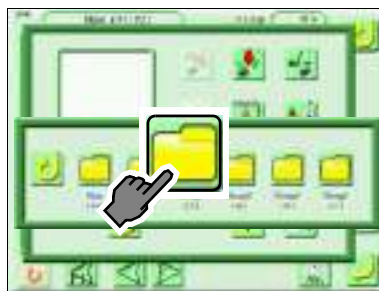

2-3. To change design name

Change the name of the design saved in the machine memory by one design unit.

[How to operate]

(1) Icon A

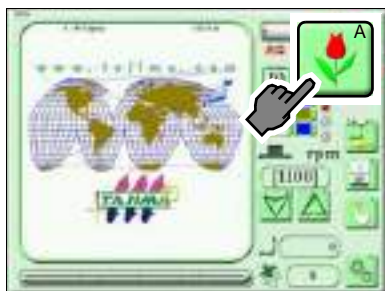

(2) Target design

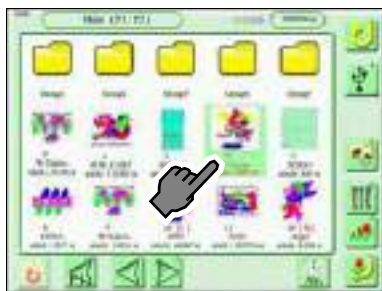

(3) Icon D

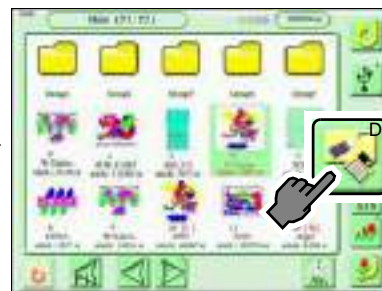

(4) To set

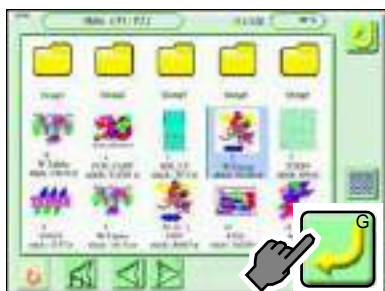

(5) Icon J



(6) To change design name^[1]

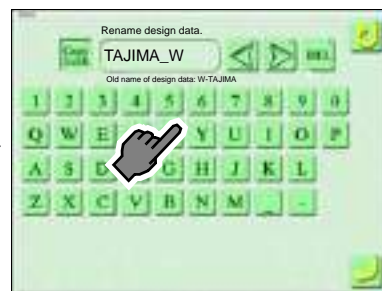

[1]Up to 8 characters can be set for a design name.

(7) To set (Completed)

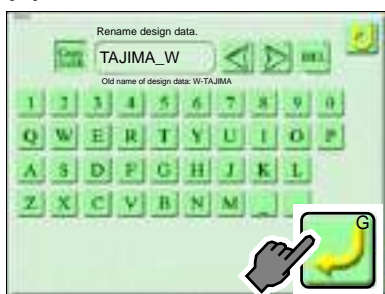

3. To edit design

The design saved in the machine memory is targeted.

To use this function, it is necessary to set the functional limit level to "SEL" by inputting a password.(→p.176)

3-1. To search stitch by specifying stitch No.

[How to operate]

Example: 480th stitch will be searched.

(1) Switch the screen to page P8, input the password and select "SEL".(→p.176)

(2) Icon A

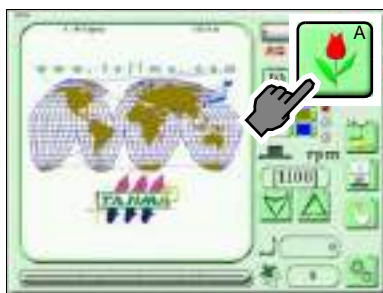

(3) Target design

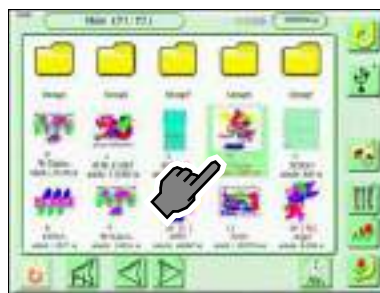

(4) Icon D

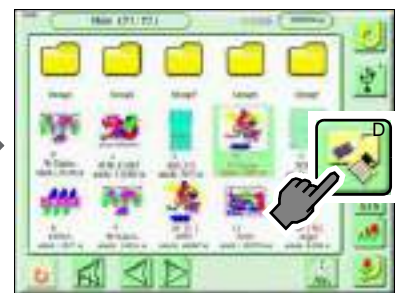

(5) To set

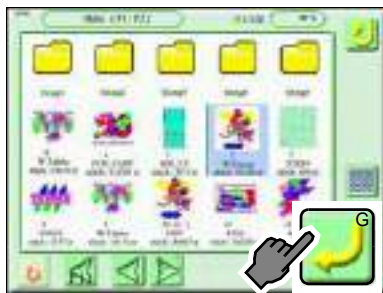

(6) Icon M



(7) Input 480

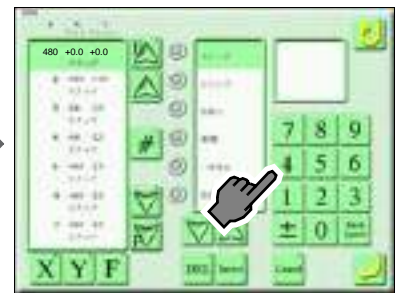

(8) Icon j (Completed)

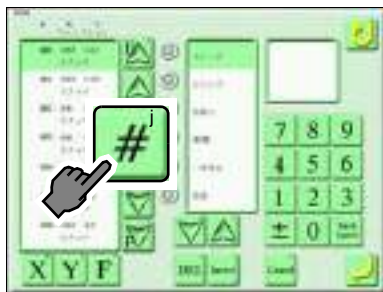

3-2. To search stitch by specifying function code

Correspondent function code to the machine and the movement are as shown in the chart below.

Function Code	Movement	Detail
Stitch	Stitches will be sewn.	
Jump	Jumping will be performed. (Frame travel without needle locating)	
Color Change	Stop by color change will be performed.	
ATH	Upper thread or upper/under threads will be trimmed automatically. ^[1]	Upper thread, upper/under threads
Temporary stop	Temporary stop will be performed at stitch or jump.	Stitch, jump
Low speed	A low speed operation will be performed at specified stitch section.	Start S, end S Start J, end J
Satin Stitch	Satin stitch conversion will be performed at specified block.	Start, end
Automatic free-setting offset	Frame travel will be performed according to the setting of automatic offset.	
Sequins	Sequin device will work at specified block.	Start, end, output 1, output 2
ATH prohibited	ATH will not be performed at specified stitch section.	Start S, end S Start J, end J

[1]This machine trims upper/under threads even if "Upper thread" is selected.

[How to operate]

Example: Search jump code and color change code.

(1) Icon A

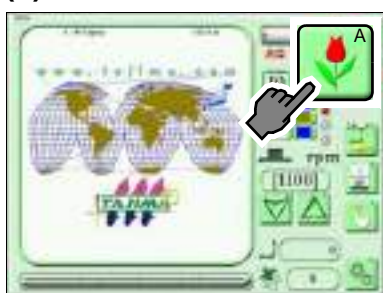

(2) Target design



(3) Icon D

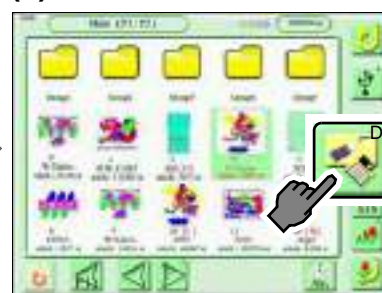

(4) To set

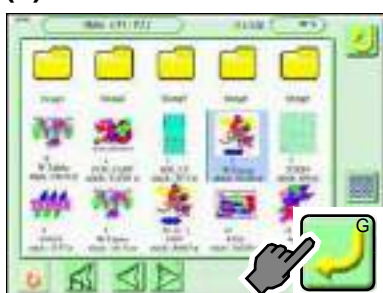

(5) Icon M

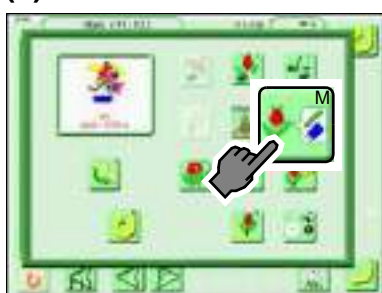

(6) Jump, color change

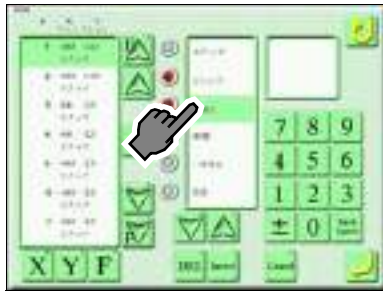

Selected item will be displayed as shown below.



(7) Icon h, or Icon l (Completed)

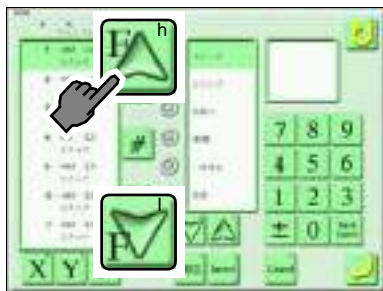

Stitches before the selected stitch will be searched.



Stitches after the selected stitch will be searched.

3-3. To insert a stitch (Input of the password is necessary)

The stitch will be inserted before the selected stitch. If a stitch with a length length is inserted, a design will be displaced hereafter.

To use this function, it is necessary to set the functional limit level to "SEL" by inputting a password. (→p.176)

[How to operate]

Example: Non-data ATH (trims upper/under threads) code will be inserted at 480th stitch.

(1) Switch the screen to page P8, input the password and select "SEL". (→p.176)

(2) Icon A

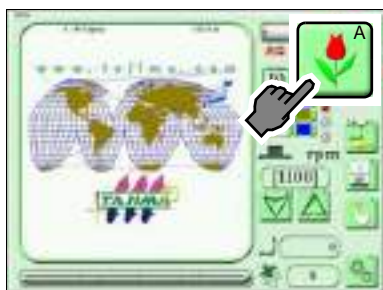

(3) Target design

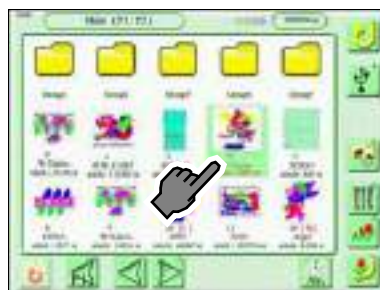

(4) Icon D

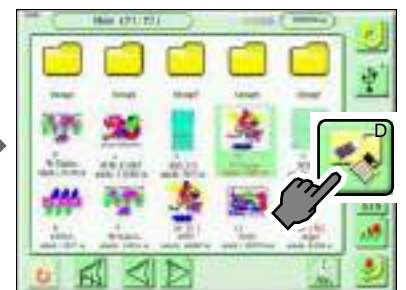

(5) To set

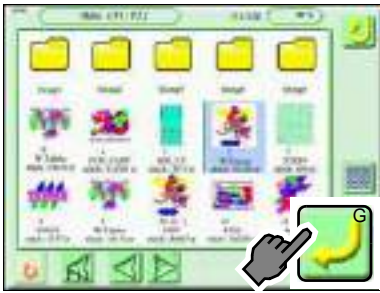

(6) Icon M



(7) Input 480

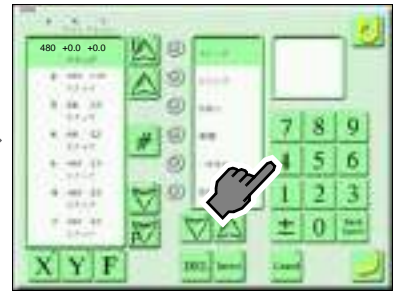

(8) Icon j



(9) Insert



(10) F



(11) ATH

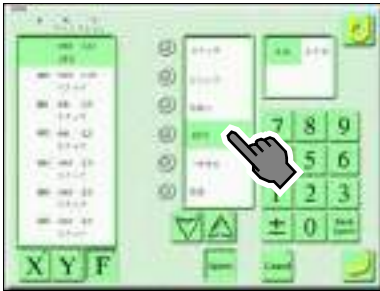

(12) Upper/under threads

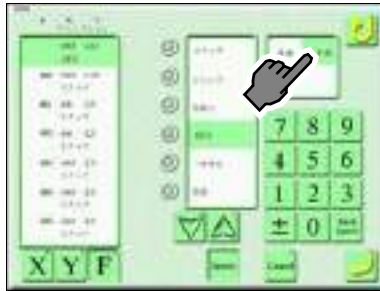

(13) To set (Completed)

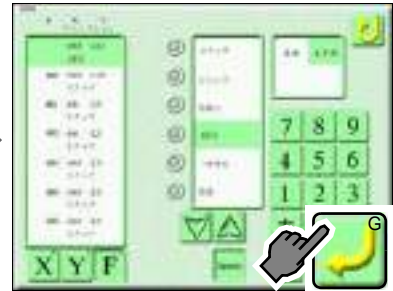

3-4. To delete a stitch (Input of the password is necessary)

If the stitch having length is deleted, a design will displace hereafter.

To use this function, it is necessary to set the functional limit level to "SEL" by inputting a password.(→p.176)

[How to operate]

Example: 480th stitch will be deleted.

(1) Switch the screen to page P8, input the password and select "SEL".(→p.176)

(2) Icon A

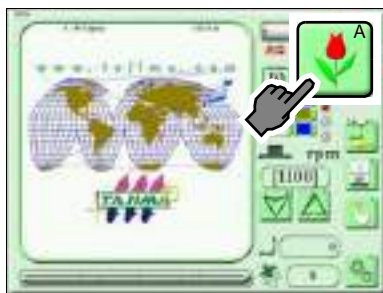

(3) Target design

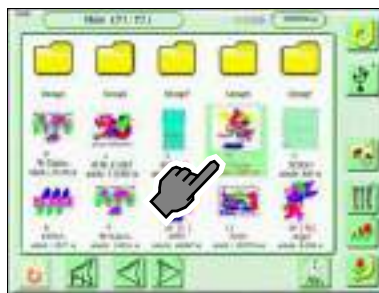

(4) Icon D

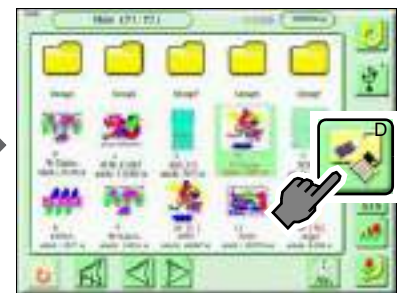

(5) To set

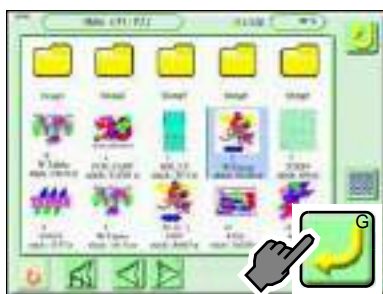

(6) Icon M



(7) Input 480

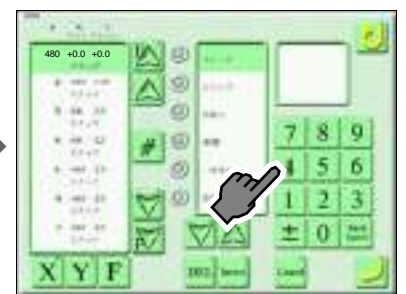

(8) Icon j

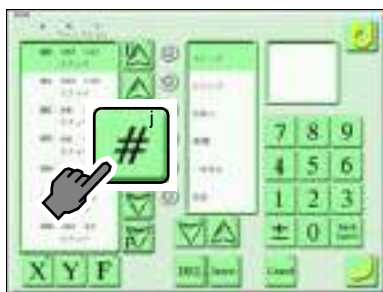

(9) DEL

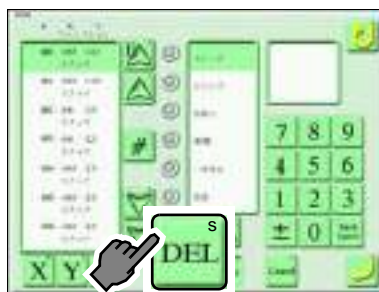

(10)To set (Completed)



3-5. To modify a stitch (Input of the password is necessary)

If stitch length after change is different from that before change, a design will displace hereafter.

To use this function, it is necessary to set the functional limit level to "SEL" by inputting a password.(→p.176)

[How to operate]

Example: Modify the stitch code at 480th stitch to jump code.

(1) Switch the screen to page P8, input the password and select "SEL".(→p.176)

(2) Icon A

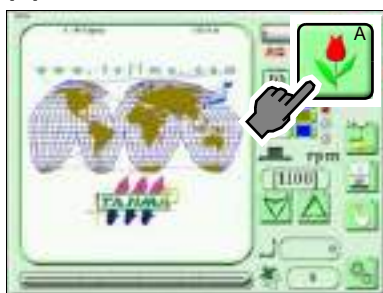

(3) Target design

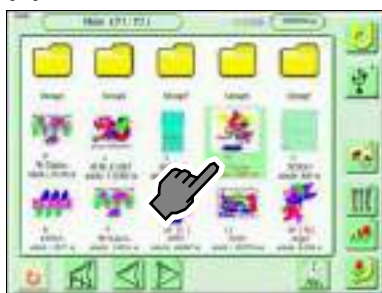

(4) Icon D

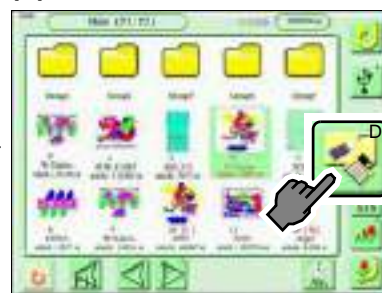

(5) To set



(6) Icon M



(7) Input 480



(8) Icon j

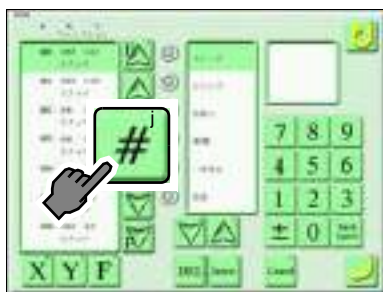

(9) F

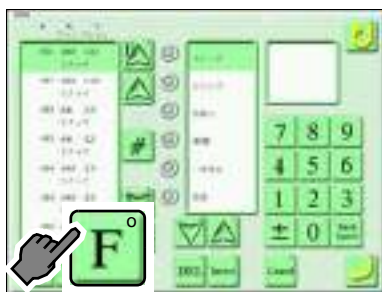

(10) Jump



(11) To set (Completed)

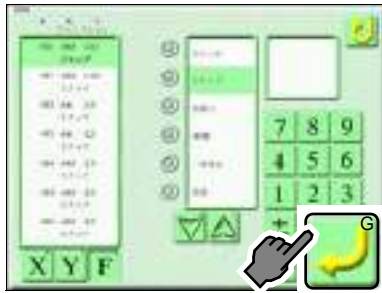

3-6. To delete small stitch

Fine stitches will be absorbed in before-and after stitches. This function is effective to reduce thread cast-off and thread breakage. It is possible to process designs in the same layer without limit.

CAUTION

The previous design will be overwritten after removing tiny stitches. Back up the design according to need.

[How to operate]

Example: Select two designs and delete the stitches of 0.5 mm or less in the designs.

(1) Icon A

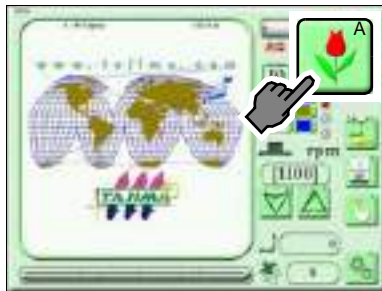

(2) 1st design



(3) Icon D

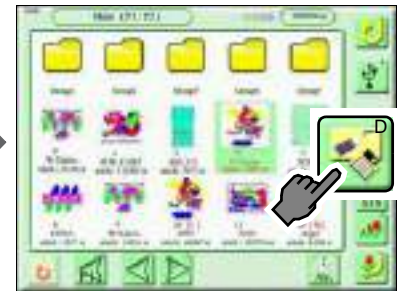

(4) 2nd design



If this icon is pressed, all designs will be selected.



If this icon is pressed, selecting the design will be canceled.

(5) To set



(6) Icon L



(7) 0.5

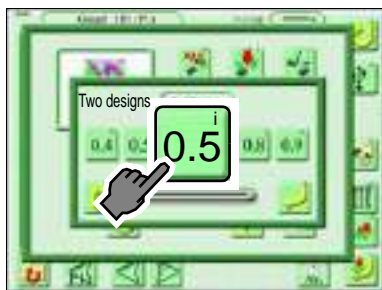

When the selected design is one design, icon b will appear. If you press icon b, the number of removable stitches will be displayed.

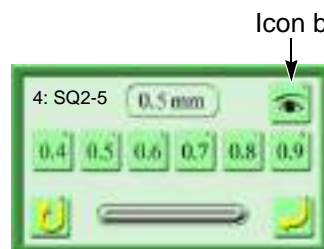

(8) To set

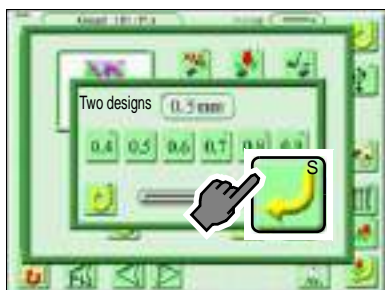

(9) Yes (Completed)

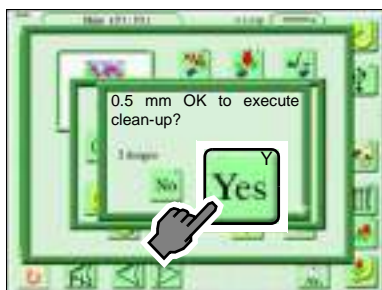

4. To copy, to divide and to combine design

The design saved in the machine memory is targeted.

4-1. To copy design

It is possible to copy designs without limit.

[How to operate]

Example: Select two designs and copy them in the saving place "Group 2" of the design.

(1) Icon A

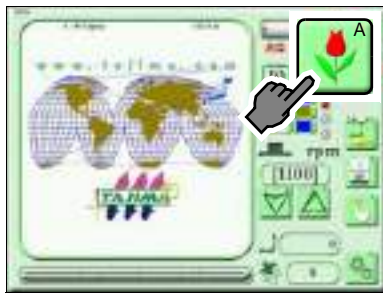

(2) 1st design

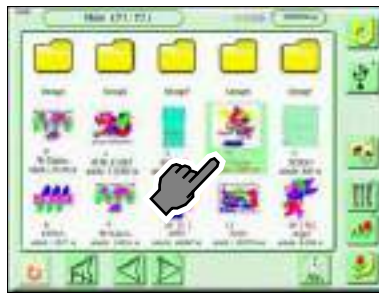

(3) Icon D

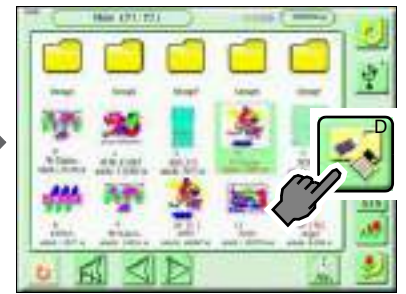

(4) 2nd design



If this icon is pressed, all designs will be selected.



If this icon is pressed, selecting the design will be canceled.

(5) To set

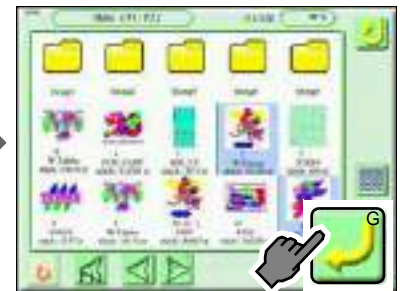

(6) Icon N

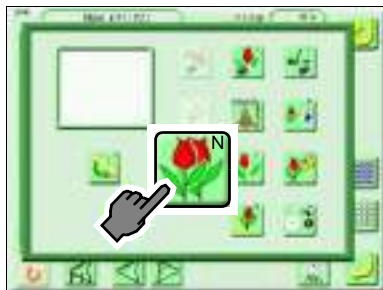

(7) Group 2 (Completed)



4-2. To divide design

Design can be divided at the specified stitch by this function.

[How to operate]

Example: Divide the design by the color change code of a design.

 **CAUTION**

 Previous design will be divided by this operation. Back up the design as necessary.

(1) Icon A

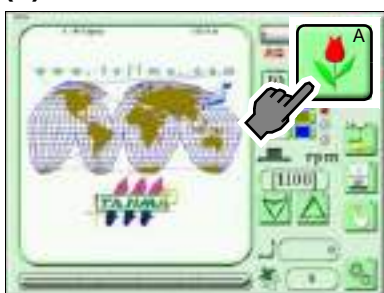

(2) Design to divide

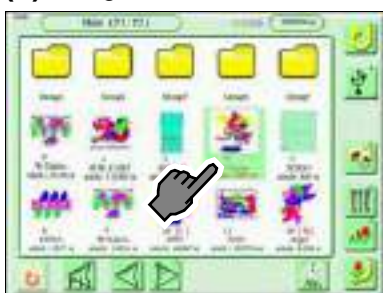

(3) Icon D



(4) To set

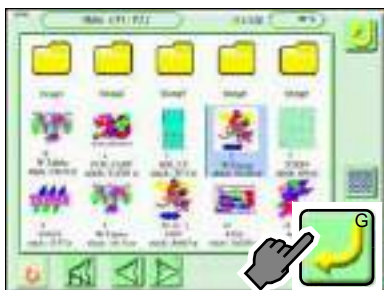

(5) Icon I

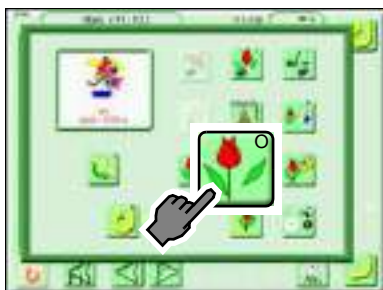

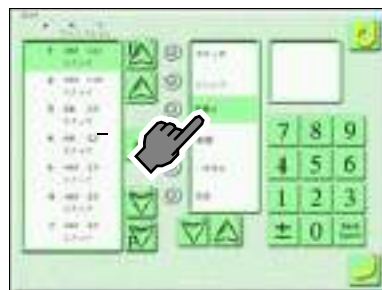

(6) Color Change

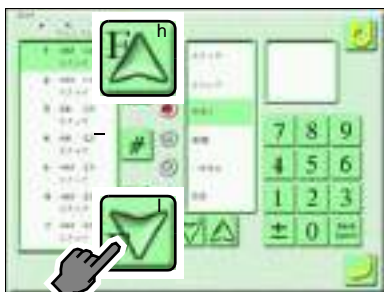

(7) Icon h, or Icon l



 Icon h Stitches before the selected stitch will be searched.

 Icon l Stitches after the selected stitch will be searched.

(8) To set

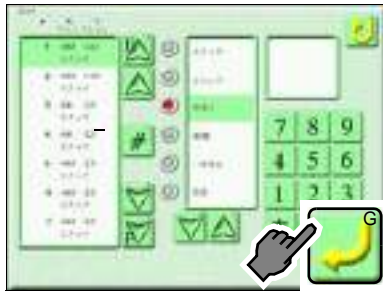

(9) Yes (Completed)

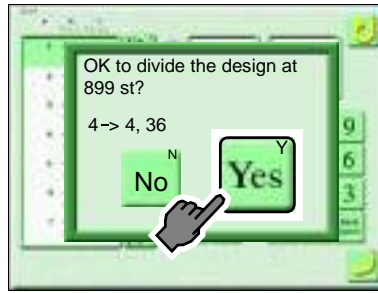

The design of a memory No.4 will be divided to a memory No.4 and that No.36 and saved in a example shown left.

4-3. To combine design

Combine the plural designs, and save as one design in the machine memory.

[How to operate]

Example: Combine two designs.

(1) Icon A

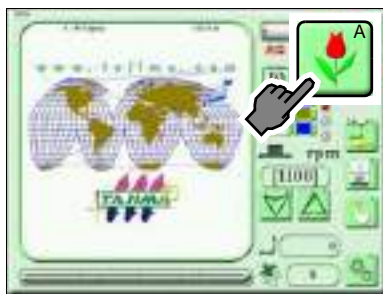

(2) 1st design



(3) Icon D

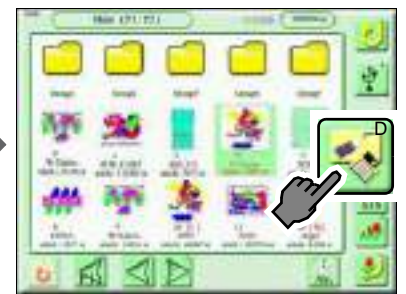

(4) To set

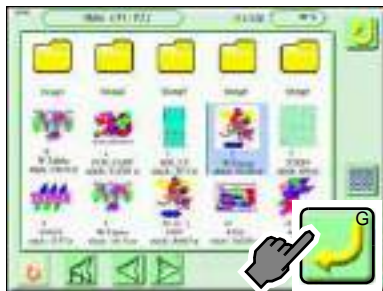

(5) Icon P



(6) Icon E



(7) 2nd design



(8) To set



(9) 1st design



When deleting 2nd design, press "DEL" key with selecting 2nd design.
To copy a design, press "Insert" key while selecting a design.

(10) Icon F



(11) Start position



Input X/Y coordinates of the start position with numerical key.

(12) To set



(13) 2nd design



(14) Icon F



(15) Start position



(16) To set



(17) To set (Completed)



[How to operate]

Example: Combine three designs.

(1) Icon A

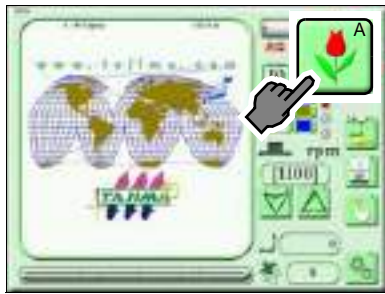

(2) 1st design

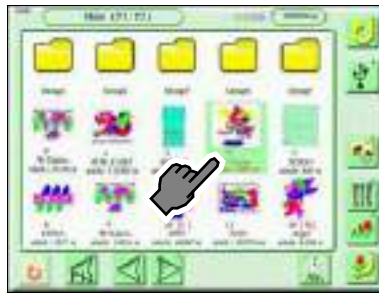

(3) Icon D

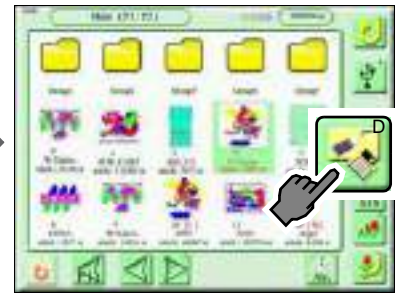

(4) To set

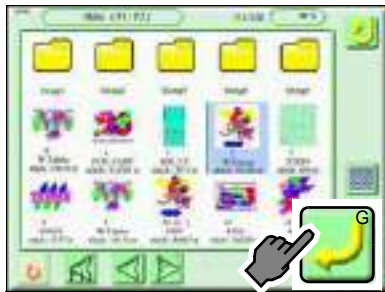

(5) Icon P



(6) Icon E

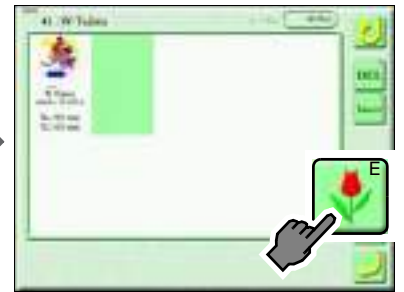

(7) 2nd design



(8) To set



(9) Space of 3rd design



(10) Icon E



(11) 3rd design

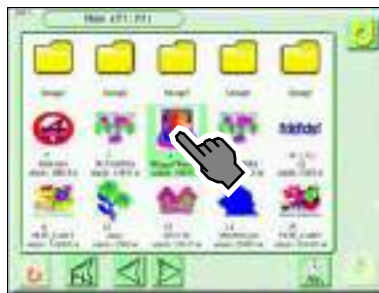

(12) To set

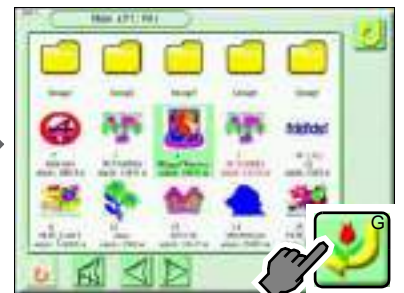

(13) After that, decide the start position of 1st design. (→p.94)

Chapter 7

Convenient functions

1. To move the frame to the position registered	98
2. To change size of design/To change direction of design (Data conversion) ...	104
3. To embroider repeatedly (Repeat).....	108
4. Advanced setting of the needle bar step	113
5. To select working head to embroider (Head selection).....	119
6. Needle bar color	123
7. Head group.....	124
8. Marking.....	125

1. To move the frame to the position registered

1-1. To move the frame automatically at the start and the end of embroidery (Automatic Offset)

The frame will move automatically between offset position and start position so that replacement of the frame and the fabric to be stretched can be performed easily. Regarding this function, refer to the detail page.(→p.193)

The frame can move through one spot of the middle position. Setting contents here will be added in the design. So, when you embroider this design next time, setting again will be unnecessary.

! CAUTION

⊘ When performing this operation, do not put your hands, etc. on the table. Moving the frame could injure you.

[How to operate]

Example:

Automatic offset will be set and the frame will be moved through one spot (OF1). The below example is an illustration that indicates the frame movement by arrows.

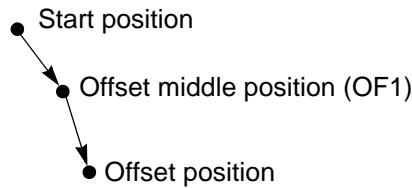

(1) Icon A

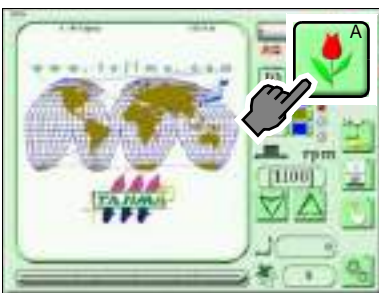

(2) Design

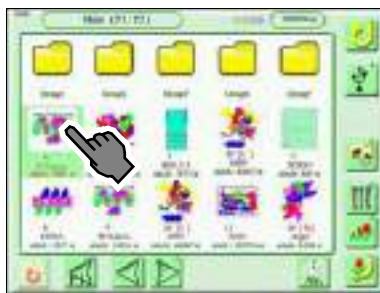

(3) Icon F

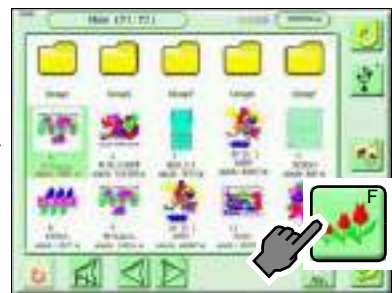

(4) OF



(5) Offset setting screen



Move the frame by the next operation.

(6) Start position

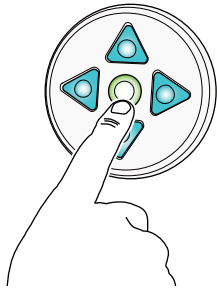

Move the frame to the start position by pressing the frame travel key.

- Start position

(7) Icon S

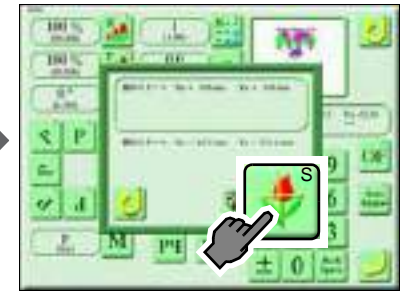

(8) Offset middle position

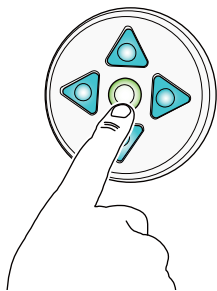

Move the frame to the offset middle position by pressing the frame travel key.

- Start position
- Offset middle position

(9) OF1

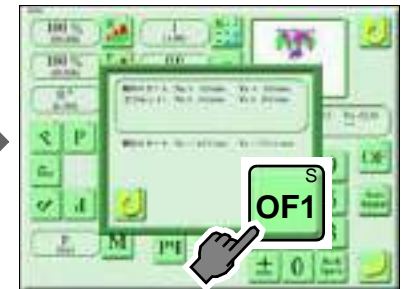

(10) Offset position

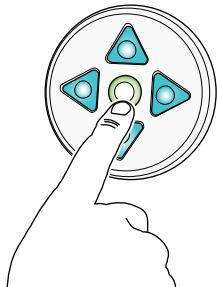

Move the frame to the offset position by pressing the frame travel key.

- Start position
- Offset middle position
- Offset position

(11) OF2

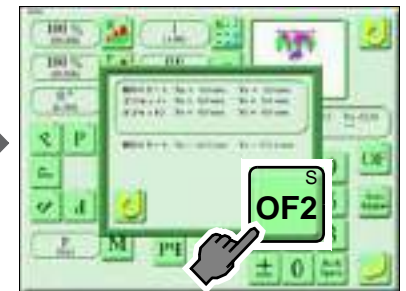

(12) To set (Completed)



1-2. To delete frame position registered (Automatic offset deletion)

! CAUTION

⊘ When performing this operation, do not put your hands, etc. on the table. Moving the frame could injure you.

[How to operate]

(1) Icon A

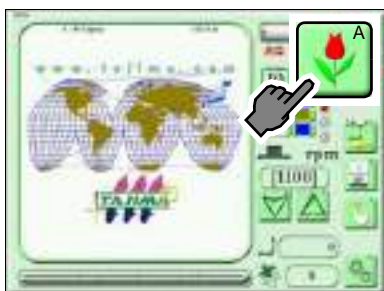

(2) Design

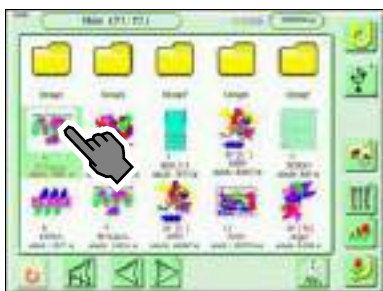

(3) Icon F

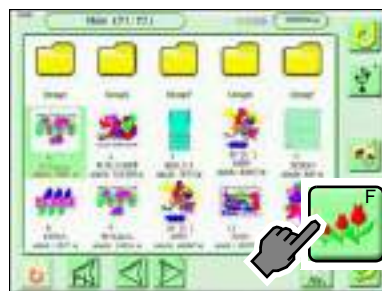

(4) OF



(5) Icon H



(6) Yes

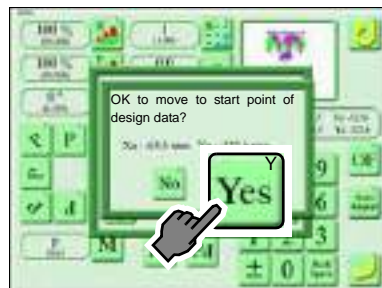

(7) Icon S

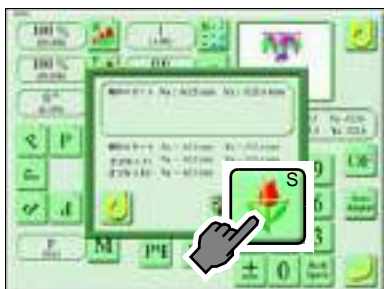

(8) OF1

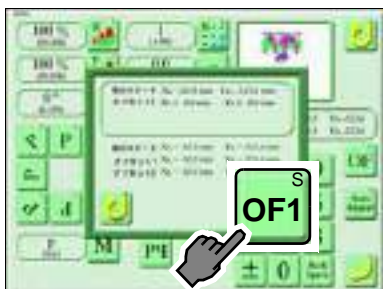

(9) To set (Completed)



1-3. To move frame at a desired position during embroidery (Automatic free setting offset)

"Automatic free-setting offset" code will be inserted in the design data. Then, the machine will stop by stitch you desire and the frame will move to the front (offset position) automatically during embroidery. Therefore, this function is suitable for works of applique and placing embroidery etc. Setting of "Automatic offset" is necessary to make this function available. (→p.98)

For this function, refer to the detail page.(→p.194)

To use this function, it is necessary to set the functional limit level to "SEL" by inputting a password.(→p.176)

[How to operate]

Example: Insert "Automatic free-setting offset" code to 480th stitch.

(1) Switch the screen to page P8, input the password and select "SEL".(→p.176)

(2) Decide the frame position by "Automatic offset".(→p.98)

(3) Icon A

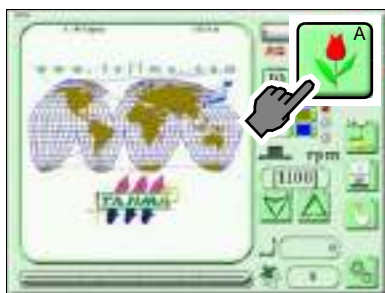

(4) Design

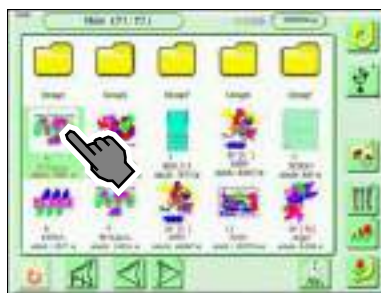

(5) Icon D

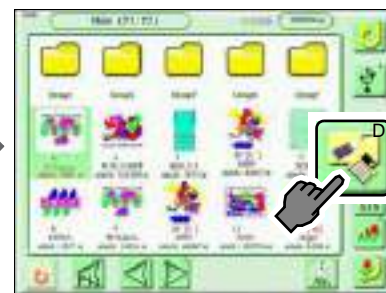

(6) To set

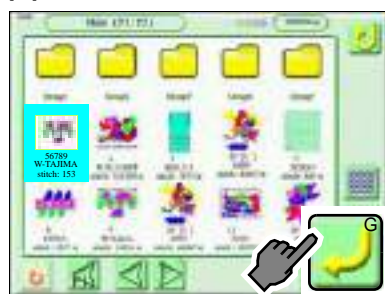

(7) Icon M



(8) Input 480

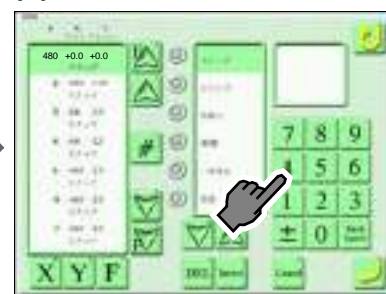

(9) Icon j

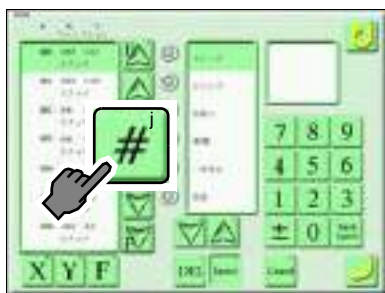

(10) Insert

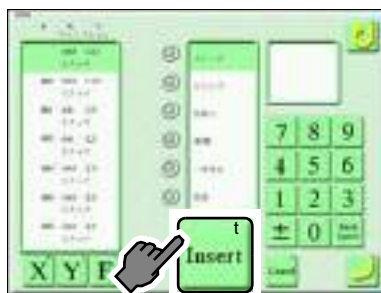

(11) F

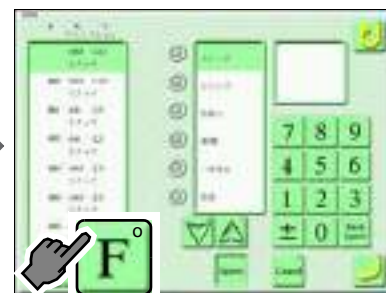

(12)Icon q

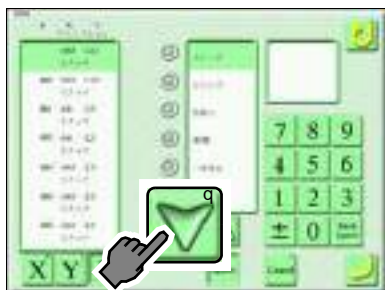

(13)Automatic free-setting offset



(14)To set (Completed)

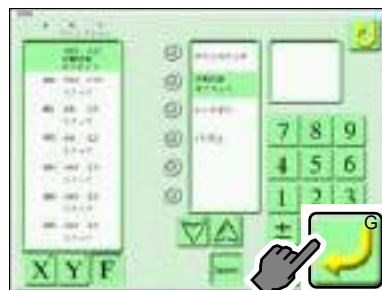

1-4. To move frame at color change position during embroidery (Auto color change offset)

"Offset" will be inserted to the needle bar step by the operation of selecting needle bar. Then, the machine will stop at the color change position you desire, and perform thread trimming, and then the frame will move to the front (offset position) automatically during embroidery. Therefore, this function is suitable for works of applique and placing embroidery etc. Setting of "Automatic offset" is necessary to make this function available. (→p.98)

For this function, refer to the detail page.(→p.195)

[How to operate]

Example: Insert "Offset" after Step 4.

(1) Decide the frame position by "Automatic offset".(→p.98)

(2) Icon A

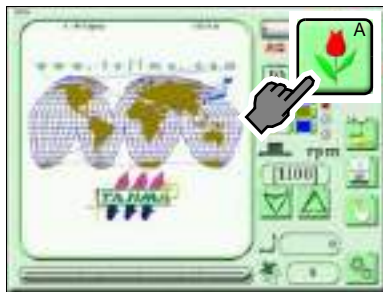

(3) Design

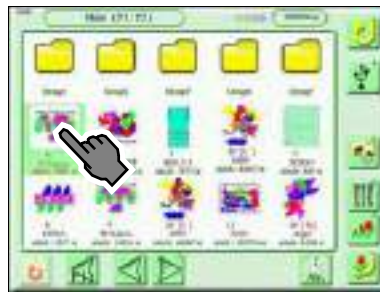

(4) Icon E

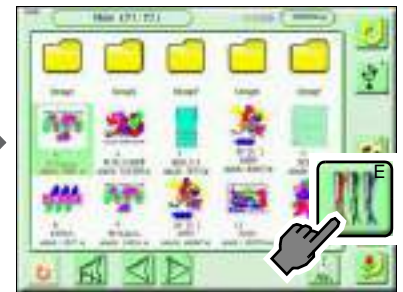

(5) Step 4

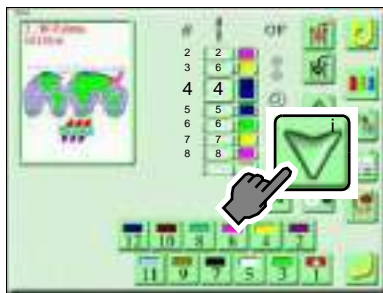

(6) OF

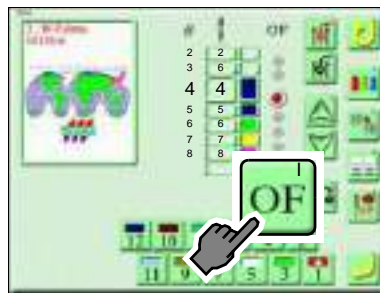

If "OF" is pressed, the offset lamp will be lit in red.



(7) To set (Completed)

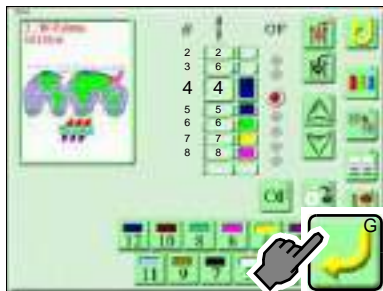

2. To change size of design/To change direction of design (Data conversion)

When the rotation and the reversion are set at the same time, the data will be changed in order from the rotation to the reversion.

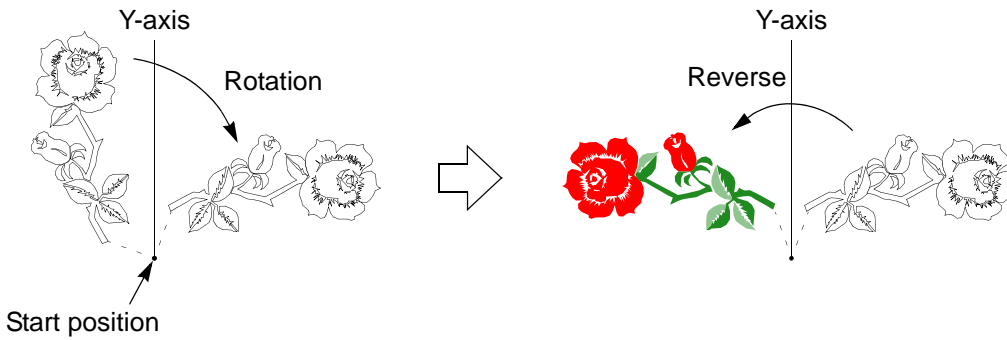

2-1. To scale up/down

[How to operate]

Example: Enlarge to 150% in vertical and horizontal.

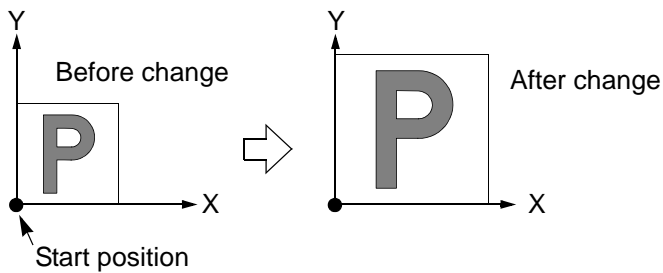

(1) Icon A

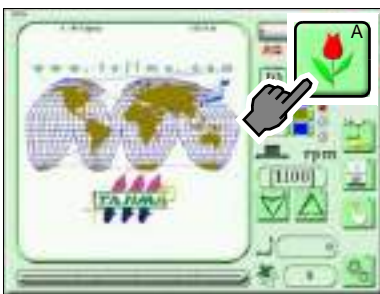

(2) Design

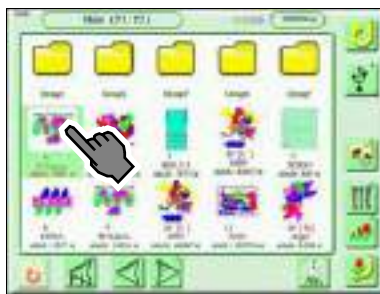

(3) Icon F

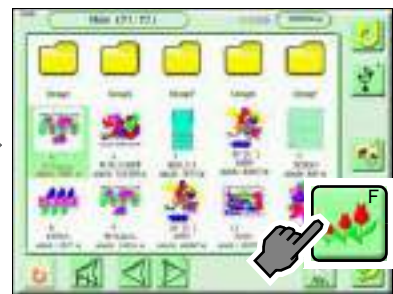

(4) X

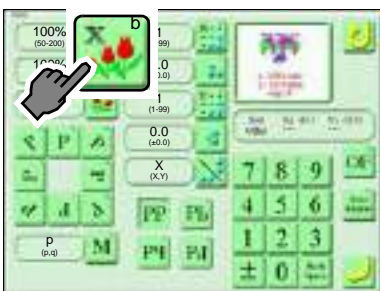

(5) 150



(6) To set (Completed)



2-2. To rotate design

[How to operate]

Example: Rotate the design by 45° unit. (45° in this example)

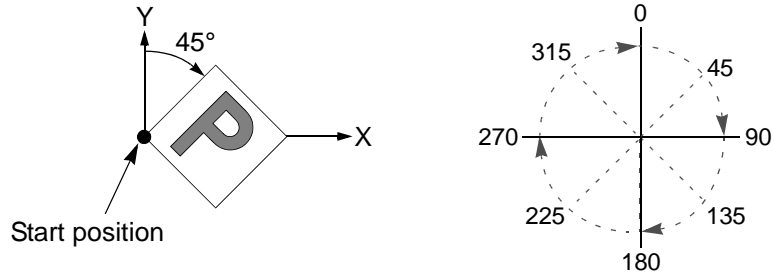

(1) Icon A

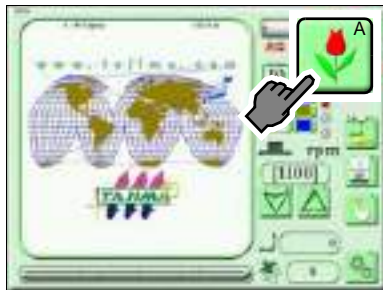

(2) Design

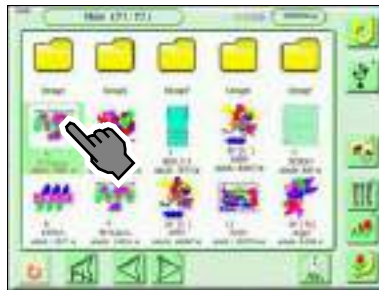

(3) Icon F

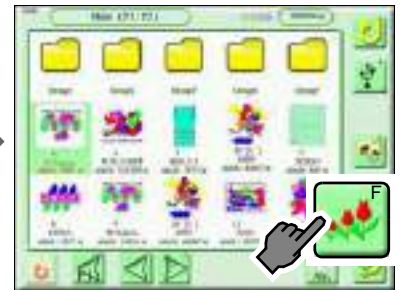

(4) Icon m

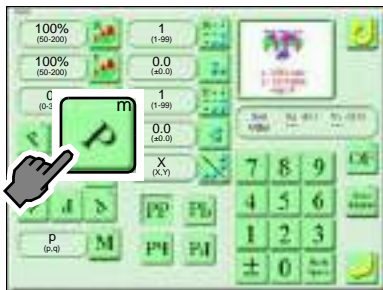

(5) To set (Completed)



[How to operate]

Example: Rotate the design by 1° unit. (5° in this example)

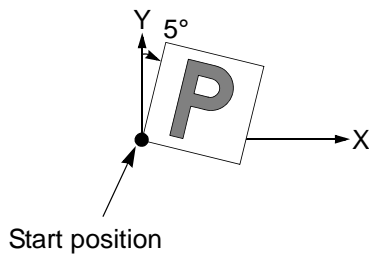

(1) Icon A

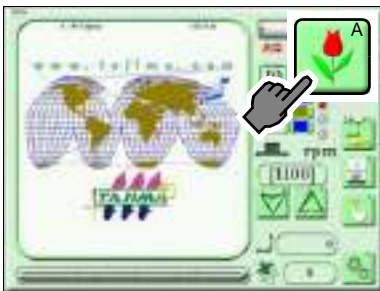

(2) Design

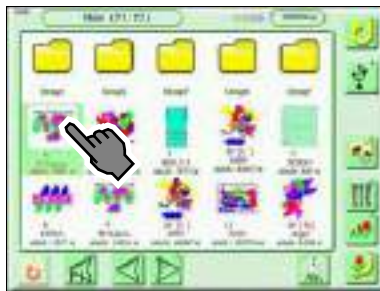

(3) Icon F

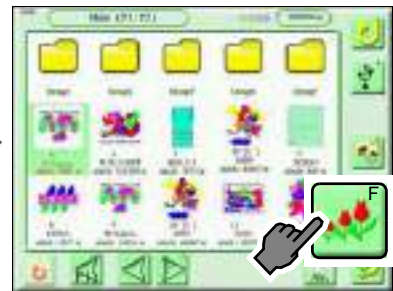

(4) Icon f

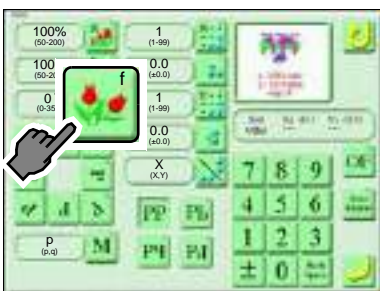

(5) 5°



(6) To set (Completed)



2-3. To reverse a design

[How to operate]

Example: Reverse the design.

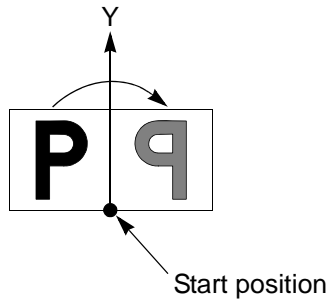

(1) Icon A

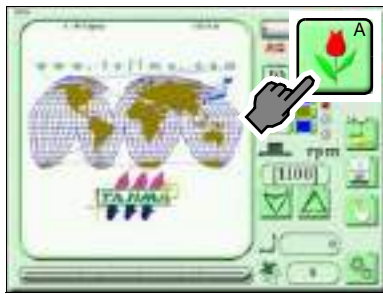

(2) Design

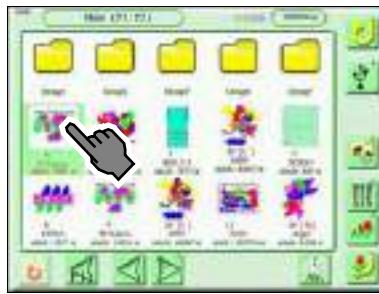

(3) Icon F

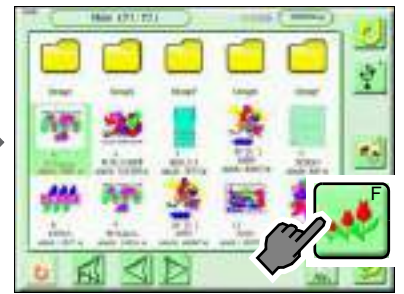

(4) M

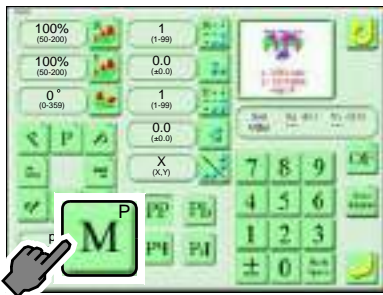

(5) To set (Completed)

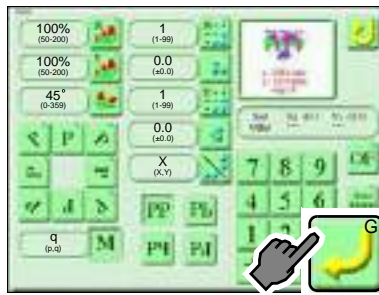

3. To embroider repeatedly (Repeat)

When repeating the design changed size and direction, this function will repeat the design of shape enlarged/ reduced, rotated and reversed.

3-1. To repeat design by specifying vertical or horizontal and number of times

[How to operate]

Example: Horizontal: 3 times, Design interval amount: +50 mm

Vertical : 2 times, Design interval amount: -60 mm

Priority direction :Horizontal

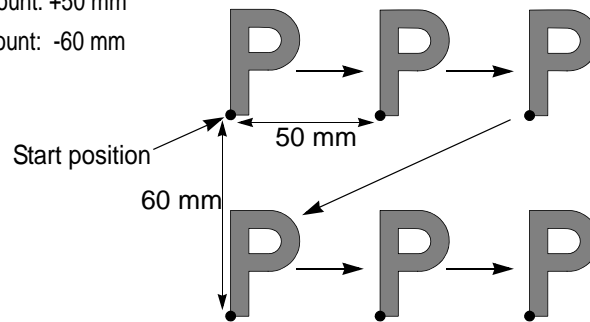

(1) Icon A

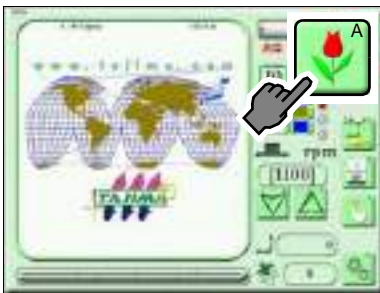

(2) Design

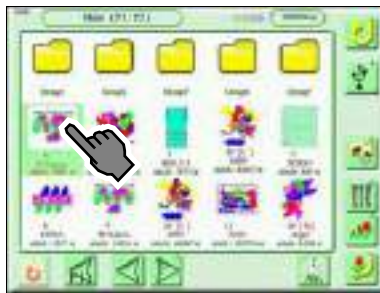

(3) Icon F

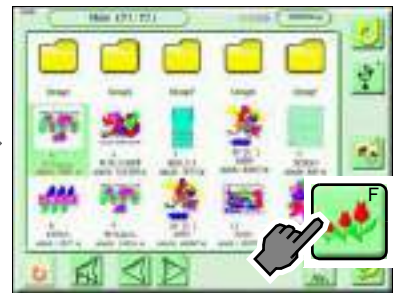

(4) X

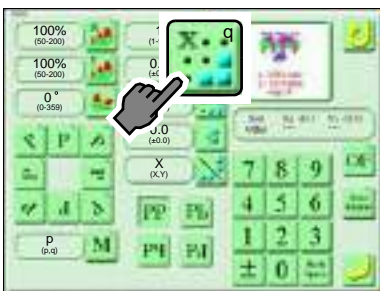

(5) 3



(6) Icon r



(7) +50.0



When repeating design to right direction

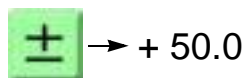

When repeating design to left direction



(8) Y



(9) 2



(10) Icon t

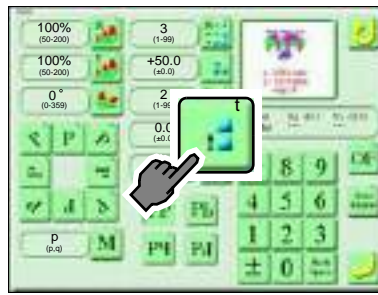

(11)-60.0



When repeating design to upper direction

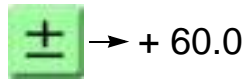

When repeating design to lower direction

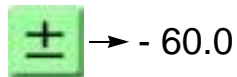

(12) To set (Completed)



3-2. To arrange design automatically

The machine will automatically calculate the number of designs that can be arranged within the embroidery space, then will perform embroidery.

[How to operate]

Example: Arrange the distance (horizontal) of the design to 50 mm, the distance (vertical) of the design to -60 mm and at the center.

(1) Icon A

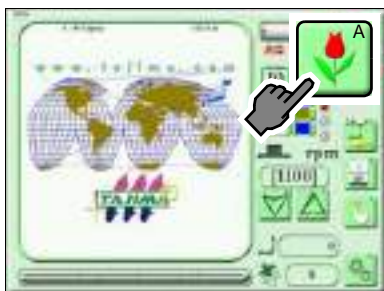

(2) Design

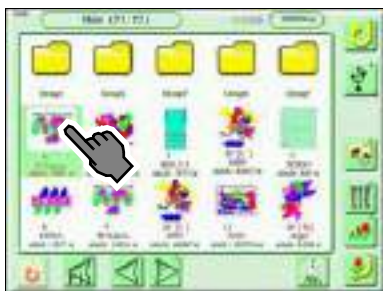

(3) Icon F

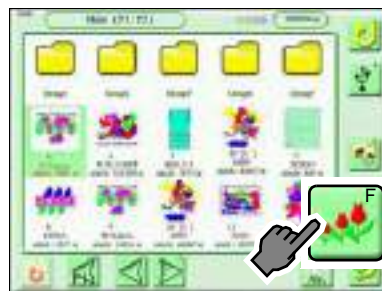

(4) Auto Repeat



(5) 50.0

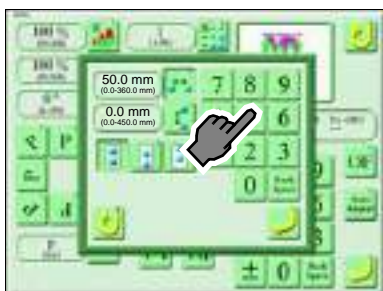

(6) Icon i

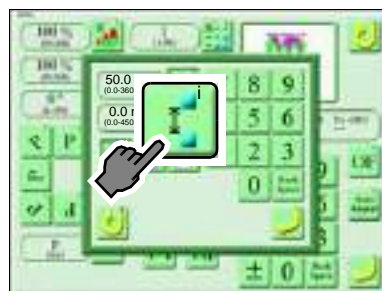

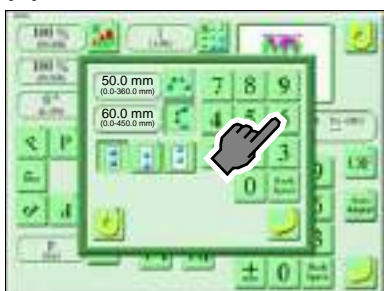

(7) 60.0

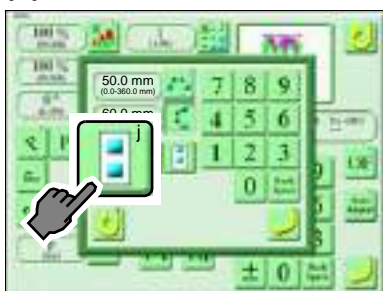

(8) Icon j



-  Arrange at the center.
-  Arrange from the front.
-  Arrange from rear.

(9) To set (Completed)

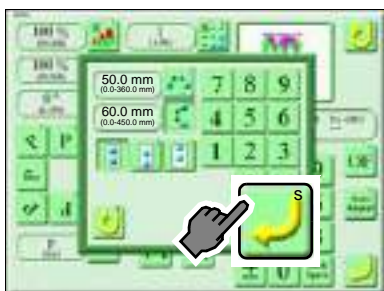

Number of repeating times in horizontal and vertical, and the start position have just been registered.

3-3. To reverse design alternately

The design being set repeat will be embroidered at odd Nth (number) time and even Nth time by reversing alternately.

[How to operate]

Example: Reverse based on X-axis.

(1) Icon A

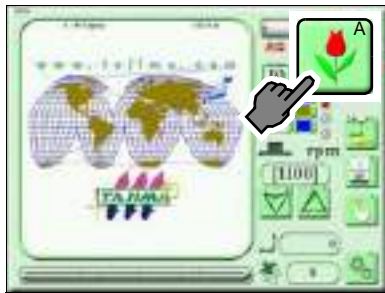

(2) Design

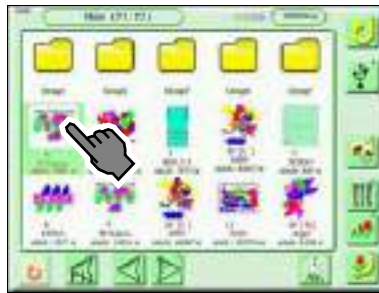

(3) Icon F

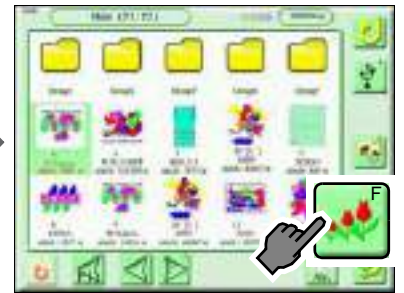

(4) X

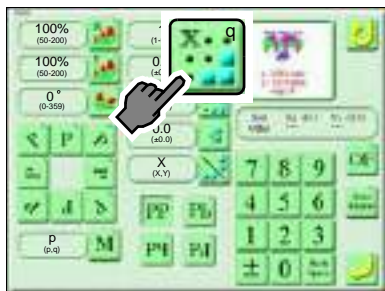

After that, set repeating time in horizontal and vertical, a distance and repeating direction.

Regarding how to operate, refer to the detail page.(→p.108)

(5) Icon x



Reverse based on X-axis.

Example: Priority in vertical

Odd-numbered times

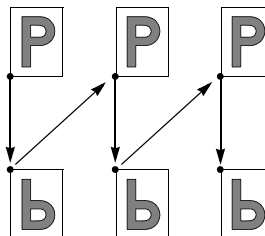

Even-numbered times

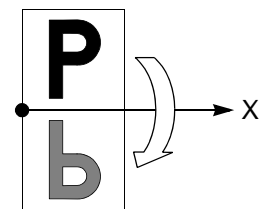



Reverse based on Y-axis.

Example: Priority in vertical

Odd-numbered times

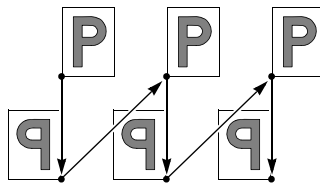

Even-numbered times

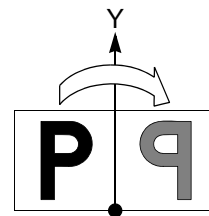

Rotate by 180°.

Example: Priority in vertical

Odd-numbered times

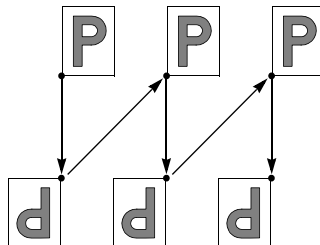

Even-numbered times

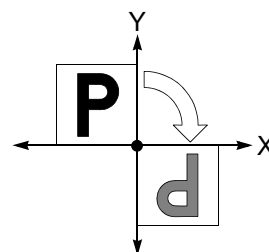

(6) To set (Completed)



4. Advanced setting of the needle bar step

4-1. To delete the needle bar selection setting

[How to operate]

Example: Delete the setting of needle bar selection at Step 4 to move up to the setting of after.

(1) Icon A

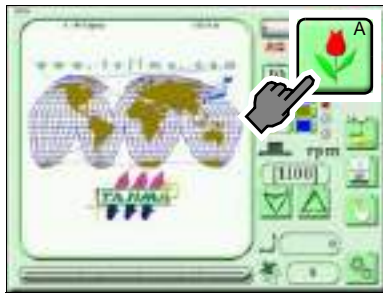

(2) Design

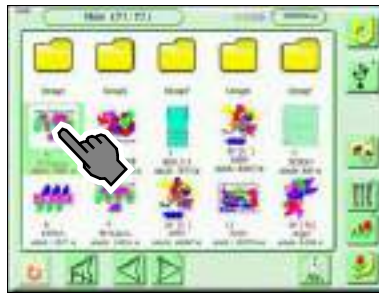

(3) Icon E

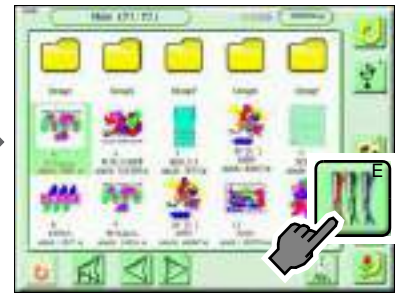

(4) Step 4

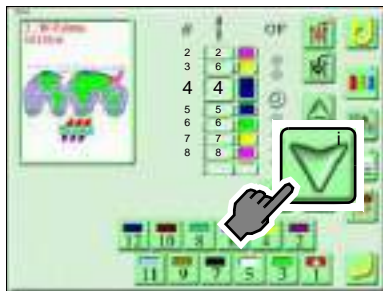

(5) Icon j

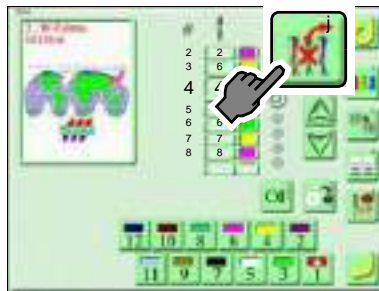

(6) To set (Completed)

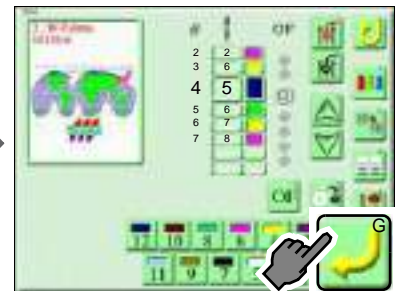

4-2. To insert a new setting in the needle bar selection setting

[How to operate]

Example: Insert step after Step 4 to move down to the setting of after.

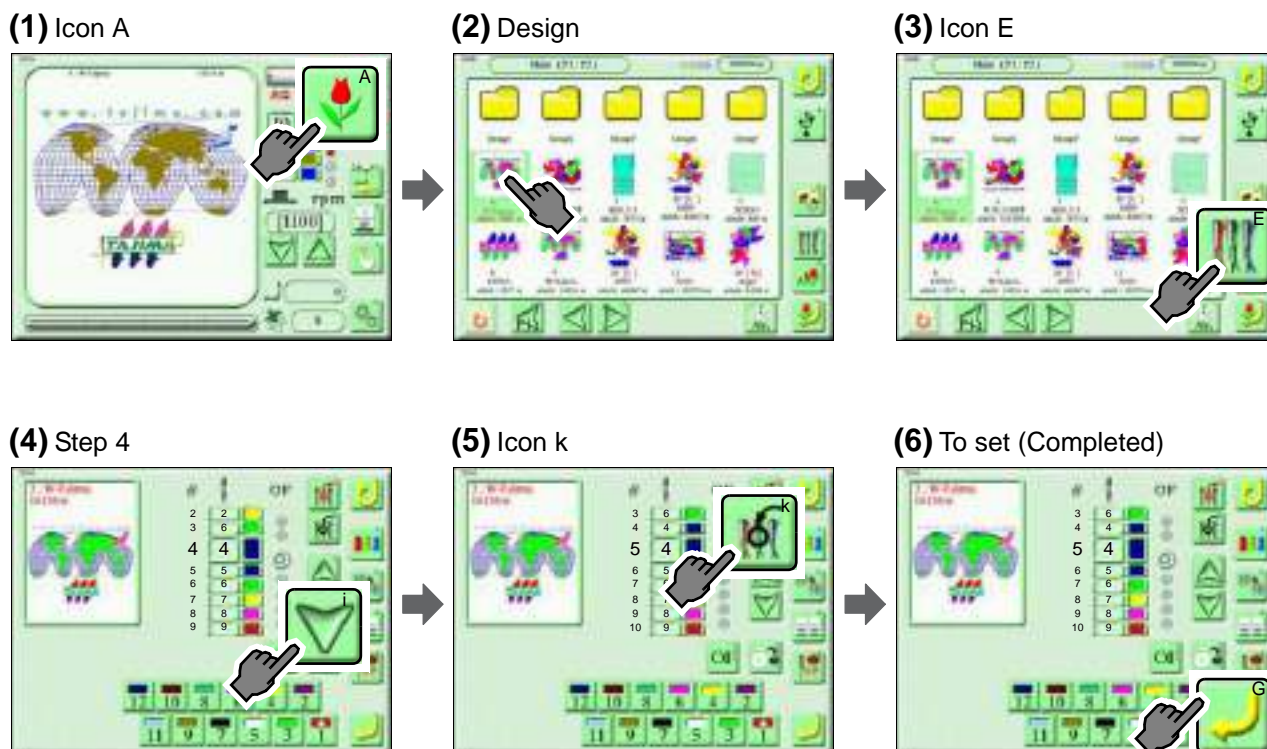

4-3. To embroider design by changing condition only for the desired step (Setting by step unit)

It is possible to give individual setting to desired steps to change the sewing condition by this machine.

For item overlapping with the setting value of the machine parameter, the value here will take priority.

[Detailed explanation]

Screen 2010

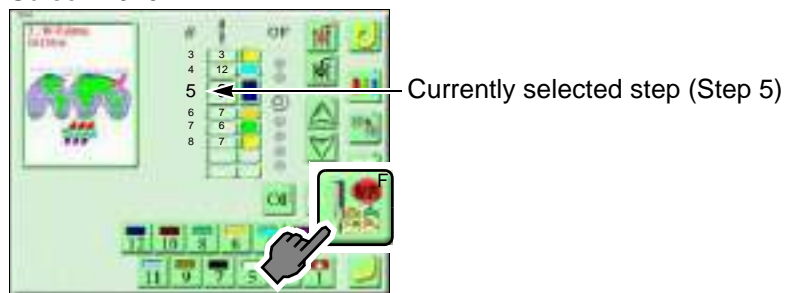

To the next page

After setting, press icon.

Enlarged

Page P1

Page P2

Screen 2010

Screen 2000 (Completed)

1. Current step (Step 5) / Total step number of design

2. Number of needle at Step 5

3. Number of jump code included in Step 5

4. Number of sequin output 1 included in Step 5

5. Number of sequin output 2 included in Step 5

6. Step 4 (one previous step)

7. Needle bar No. and needle bar color of Step 4

8. Step 6 (one step after)

9. Needle bar No. and needle bar color at Step 6

10. Needle bar selection
It is possible to change needle bar No. at Step 5.

11. Needle bar No. at Step 5

12. Whole of design is displayed.

13. A part to be sewn at Step 5 will be displayed as enlarged image.

14. When changing the value, if pressing the key longer, the value will be fast-forwarded.

15. The item changed the value will turn to red character.

16. Return the changed value to the initial value.

17. Return all values changed at screen P1 and P2 to the initial values.

Satin stitch (area) (Whole, Part, No)	Whole
Satin stitch (density) (0.4- 1.0 mm)	0.4 mm
Satin stitch (Expansion) (-1.0- +1.0 mm)	0.0 mm
FS mode (Yes, No)	Yes

If the operation level (Functional limit level) is canceled, the parameter shown on the left will be displayed.

The step changed the value will turn to red frame.

Stitching conditions are as shown in the chart below.

Page P1

Stitching condition	Setting range
Revolution Limit	250 rpm to Maximum r.p.m. of machine
Auto Jump	2.0-9.9 mm, No:A
Jump Convert	No, Yes1-9J
Thread breakage detection	No, Yes, Boring
Return / Tie stitches	Yes, No

Page P2

Stitching condition	Setting range
Satin stitch (area) ^[1]	Whole, part, No
Satin stitch (density) ^[1]	0.4 - 1.0mm
Satin stitch (Expansion) ^[1]	-1.0 - +1.0mm
FS mode	Yes, No

[1]It is displayed only when the operation level is "SEL".

[How to operate]

Example: Set Step 5 to the following stitching condition.

Needle bar No.: 9 (Changing from 6 to 9)

Revolution Limit: 700 rpm

(1) Icon A

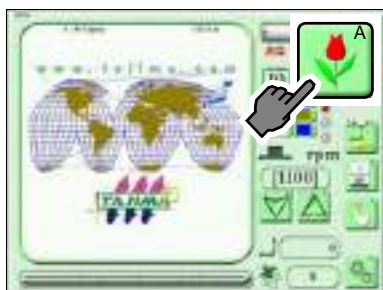

(2) Design

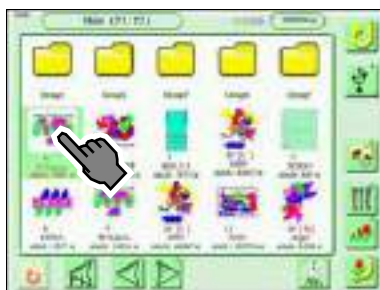

(3) Icon E

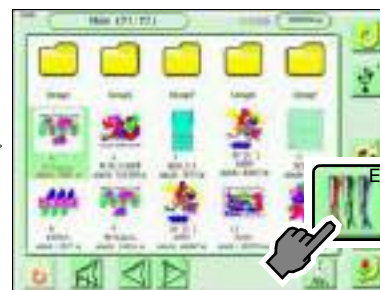

(4) Step 5

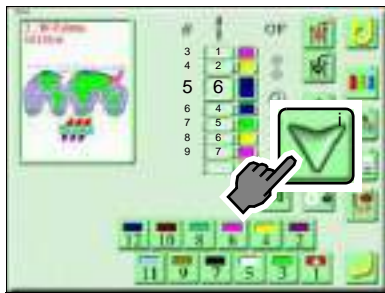

(5) Icon F

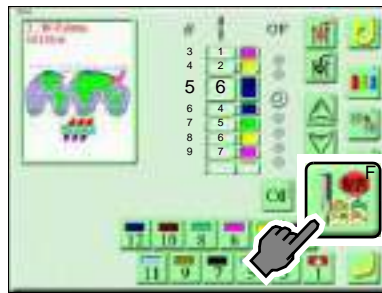

(6) Needle bar No. 9



(7) Revolution Limit



(8) 700

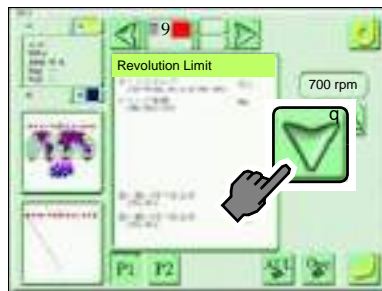

(9) To set

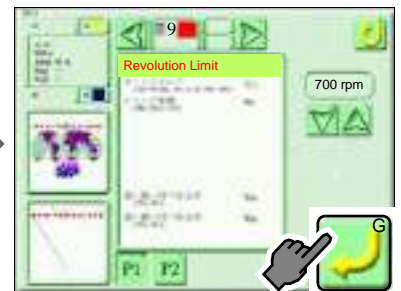

(10) Icon A

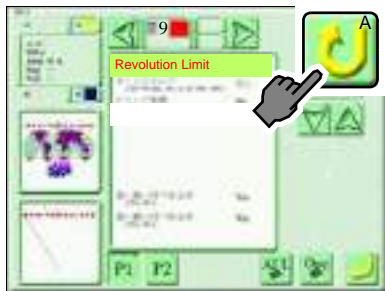

(11) To set (Completed)

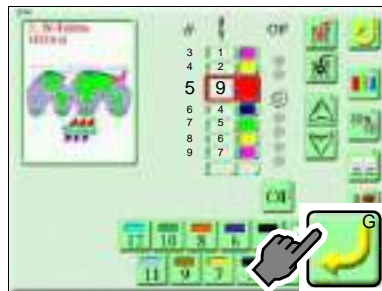

4-4. To replace specified needle bar No. with another needle bar No. in a batch
(Needle bar conversion)

[How to operate]

Example: Replace the needle bar No.8 to the needle bar No.6 in a batch.

Step No.	Needle bar No.		Needle bar No.
1	8	⇒	6
2	5		5
3	8	⇒	6
4	5		5
5	1		1
6	8	⇒	6

(1) Icon A

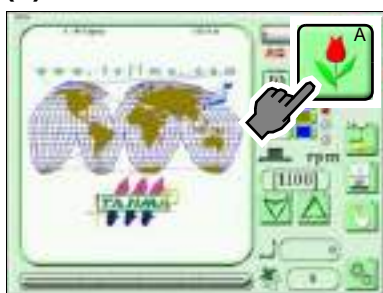

(2) Design



(3) Icon E

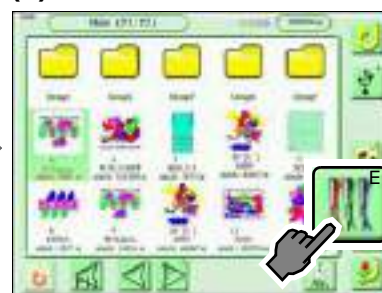

(4) Icon D

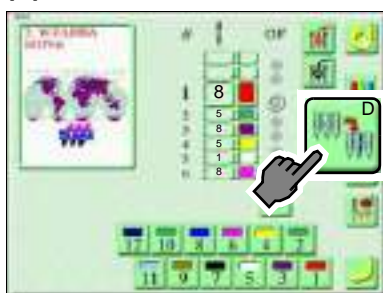

(5) Needle bar No. 8

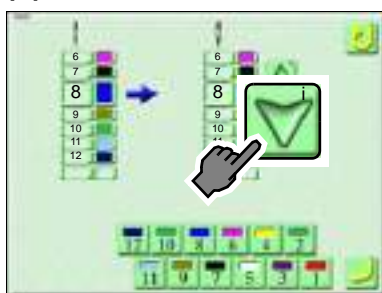

(6) Needle bar No. 6

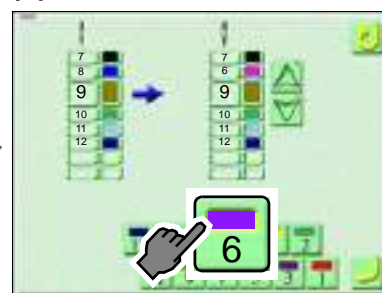

(7) To set (Completed)

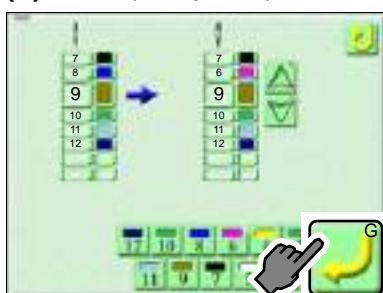

5. To select working head to embroider (Head selection)

5-1. To set pattern No. in every needle bar step

Read "Outline of function" before operation.(→p.206)

The value being set in the detail page will be applied as the pattern No.(→p.120)

[How to operate]

Example: Set the pattern No. to the needle bar step under the conditions in the chart below.

Needle bar step	Pattern No. Numbers in () mean working heads.
1	P7 (2, 4, 6, 8)
2	P5 (1, 3, 4, 6, 7)
3	P3 (2, 3, 5, 6, 8)

(1) Icon A

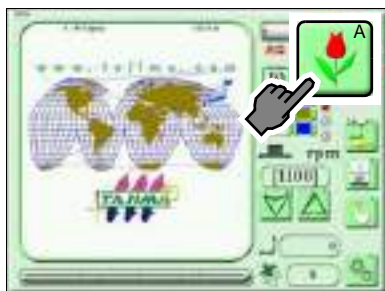

(2) Design

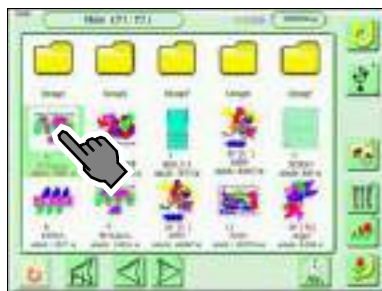

(3) Icon E

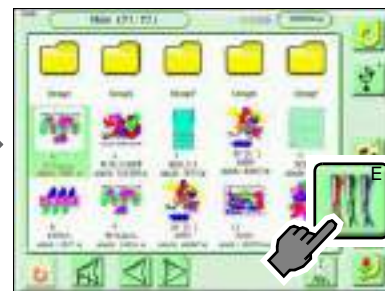

(4) Icon E

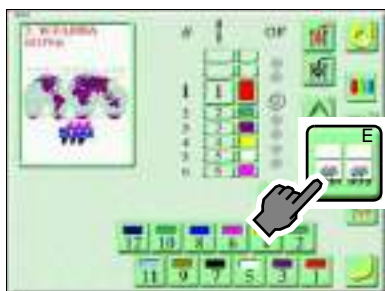

(5) Selected head

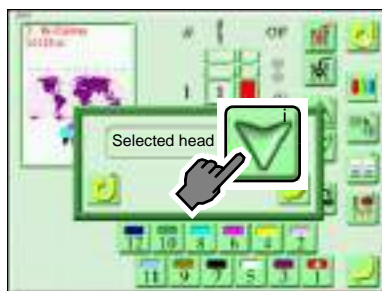

(6) To set

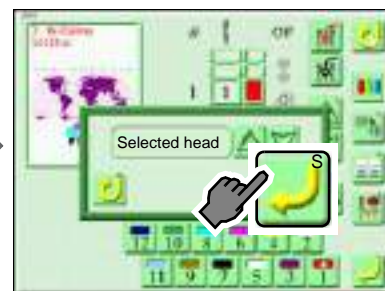

(7) P7 (Press icon twice.)

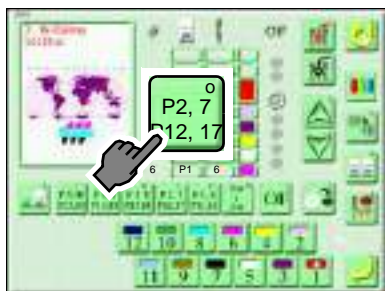

(8) Needle bar step 2

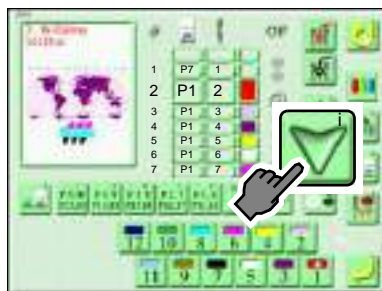

(9) P5

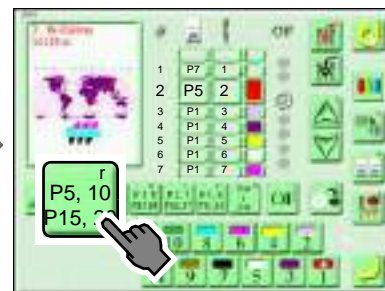

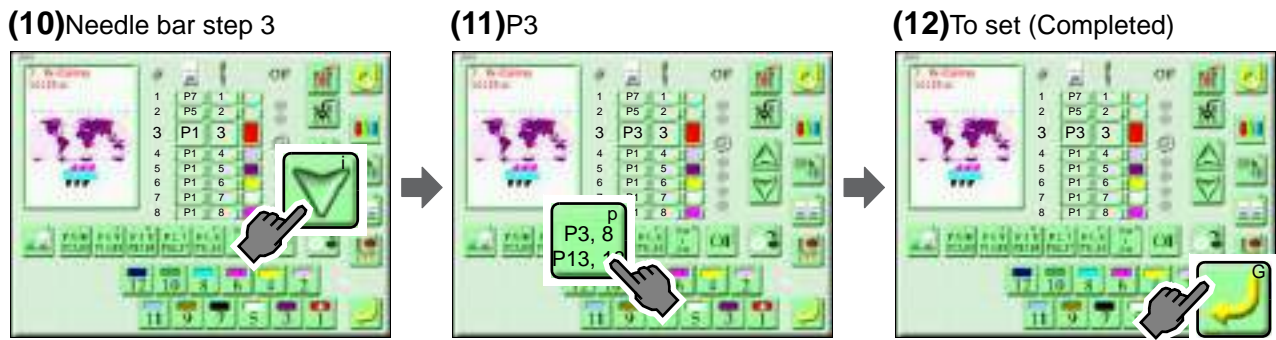

5-2. To set working head for each pattern

[How to operate]

Example: Set working head for each pattern No. under the conditions in the chart below.

Pattern No.	Working head No.
P1	2, 4, 6, 8
P2	1, 3, 4, 6, 7
P3	2, 3, 5, 6, 8
P4 and after	All heads

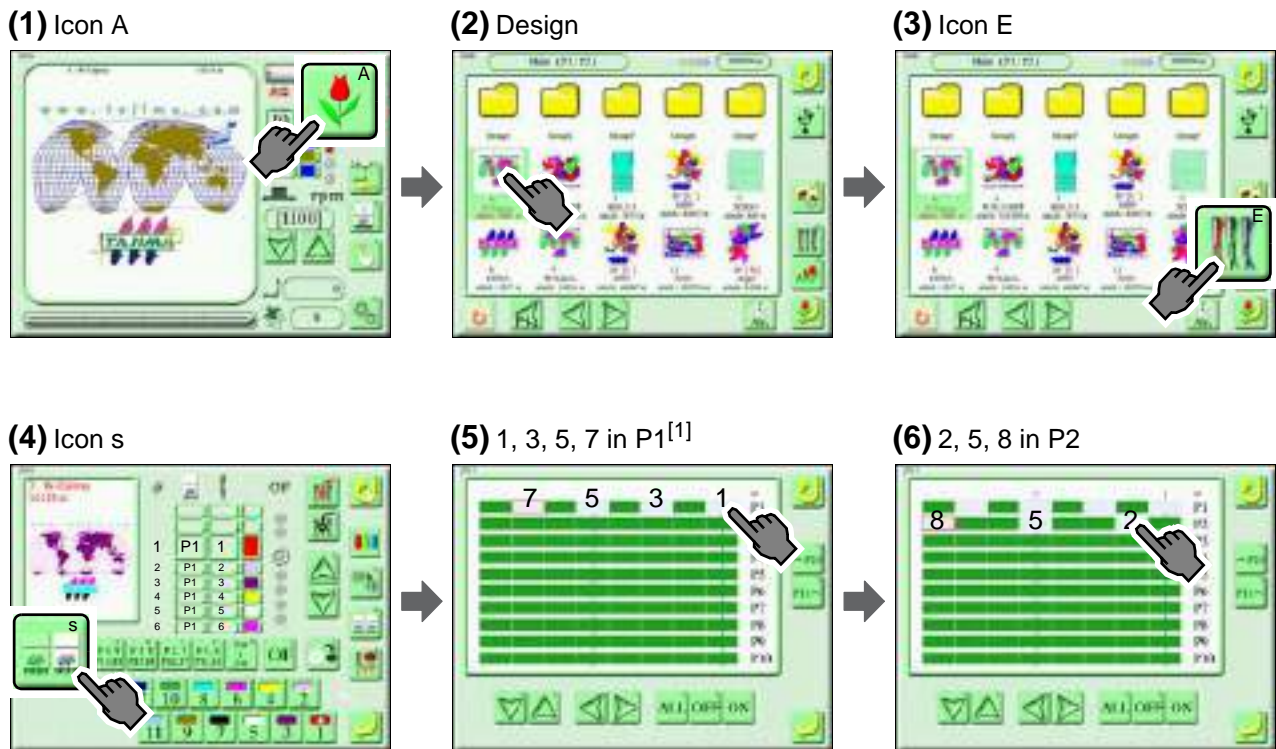

[1]Select the suspended head.

(7) 1, 4, 7 in P3

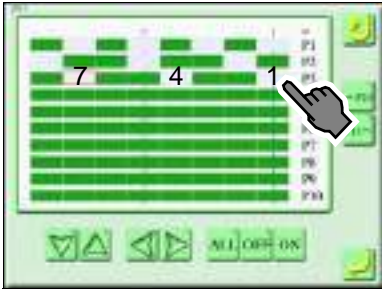

(8) To set

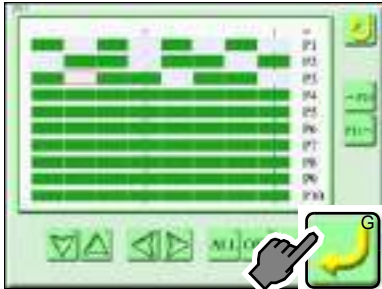

After that, perform the data set for this design.

5-3. To activate the odd-numbered head or the even-numbered head only.

[How to operate]

Example: Suspend the odd-numbered head and activate the even-numbered head only.

(1) Icon E

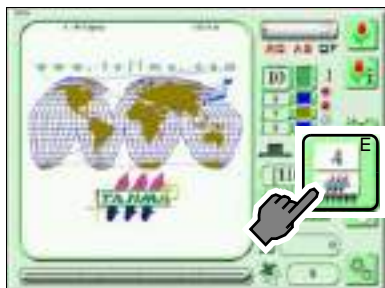

(2) Icon h



 Suspend the odd-numbered head.

 Activate the even-numbered head.

(3) Icon A (Completed)



6. Needle bar color

6-1. To change the needle bar color

[How to operate]

Example: Change the needle bar No.1 to yellow, and the needle bar No.5 to black.

(1) Icon A

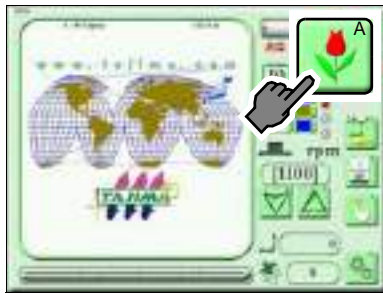

(2) Design

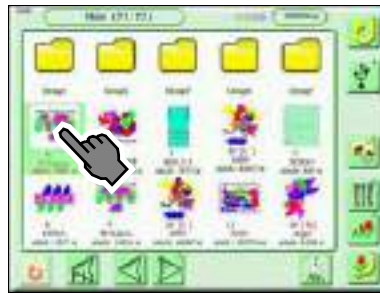

(3) Icon E

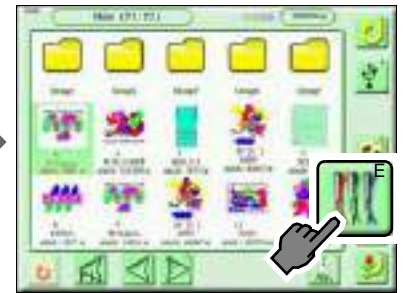

(4) Icon C

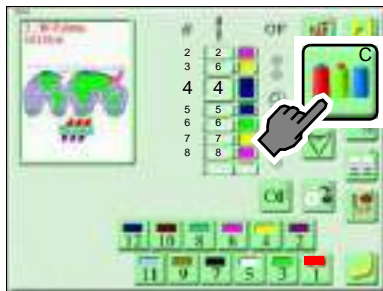

(5) Needle bar No. 1

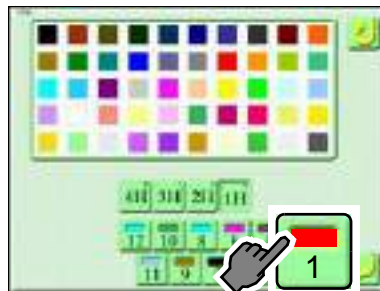

(6) Yellow



(7) Needle bar No. 5



(8) Black

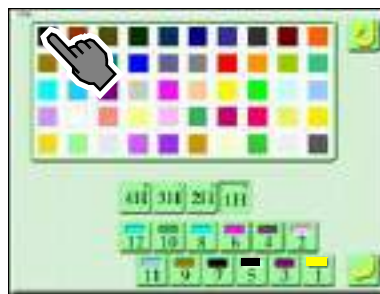

(9) To set (Completed)



7. Head group

This function groups heads (2 to 4 heads) and perform embroidery.

This function enables embroidering big sized design or color scheme exceeding the original number of stitches.

For this function, refer to the detail page.(→p.202)

[How to operate]

Example: Embroider at Head Group 2H.

(1) Icon A

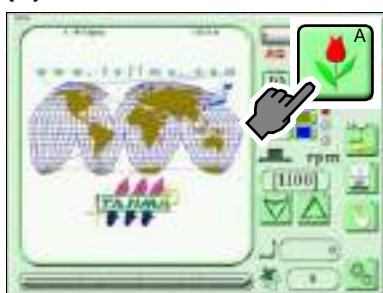

(2) Design



(3) Icon E

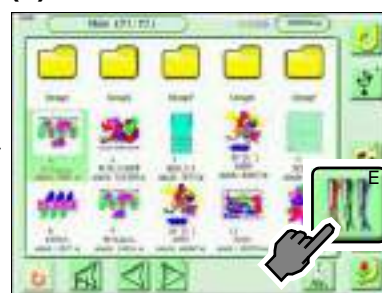

(4) Icon E

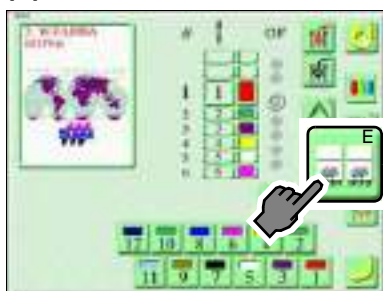

(5) 2H

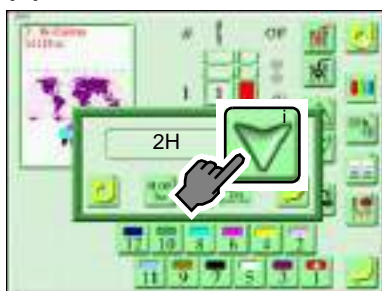

(6) H.OF Yes Frame Step^[1]

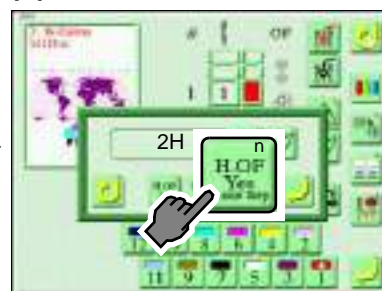

[1]When head group is not applied to "Frame Spec." of the machine, it is not possible to select head offset.

(7) To set (Completed)

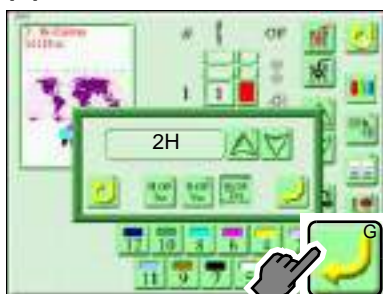

→ After that, perform the data set for this design.

8. Marking

It makes basting data (marking design) for positioning material to be embroidered in applique, placing embroidery, etc.

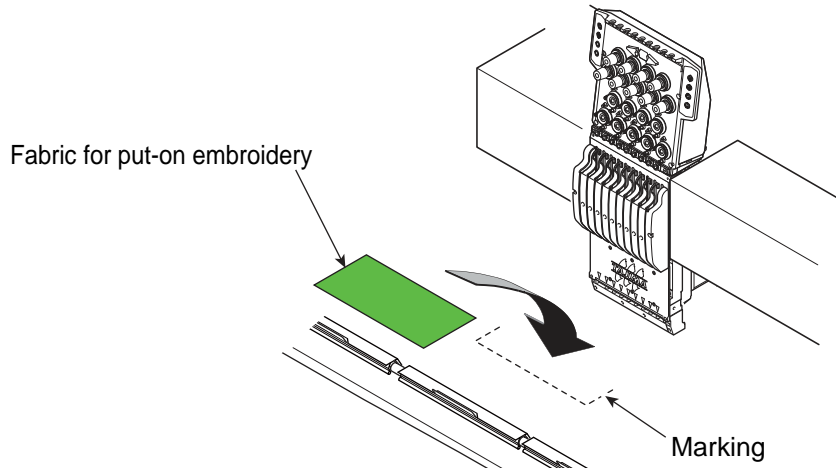

After setting Marking, the marking design will be registered automatically into a free number of the design selection screen (Screen 2000) as "M-". For this function, refer to the detail page. (→p.210)

CAUTION

 When performing this operation, do not put your hands, etc. on the table. Moving the frame could injure you.

[How to operate]

Example: Perform the marking on conditions of [Point], [With design] and "stitch length of 5.0 mm".

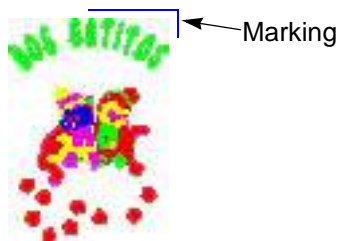

(1) Icon A

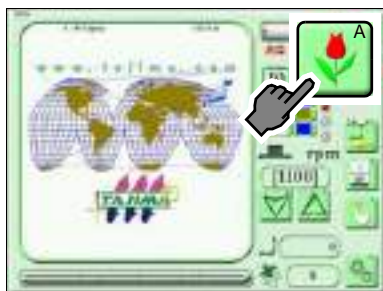

(2) Design



(3) Icon D

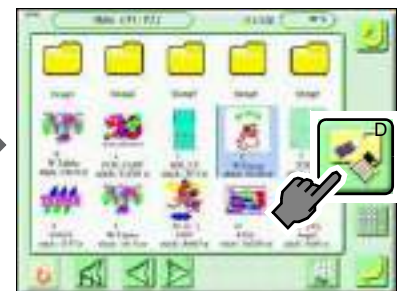

(4) To set

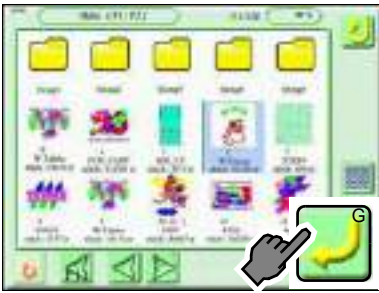

(5) Icon R

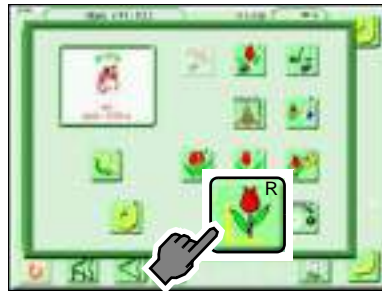

(6) Icon h

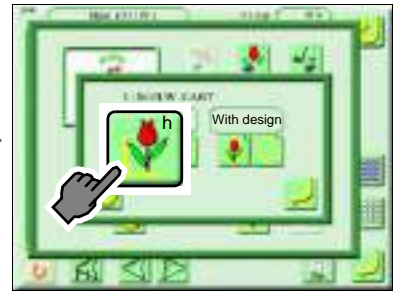

(7) Icon j

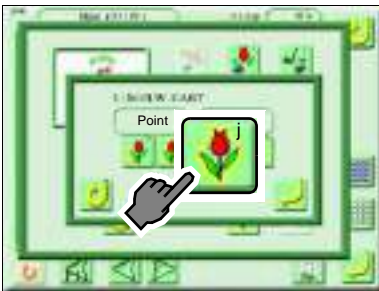

(8) To set

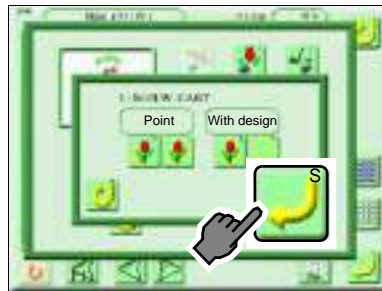

(9) OK



(10) Point 1

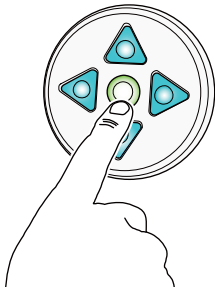

Move the frame to the point 1 by pressing the frame travel key.

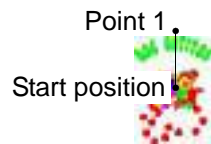

It is also possible to input coordinates by using numerical keys.

(11) OK



(12) Point 2

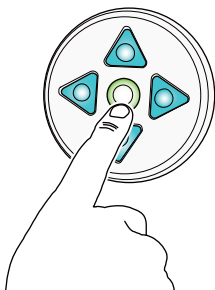

Move the frame to the point 2 by pressing the frame travel key.

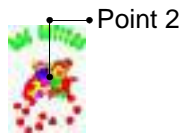

(13) OK

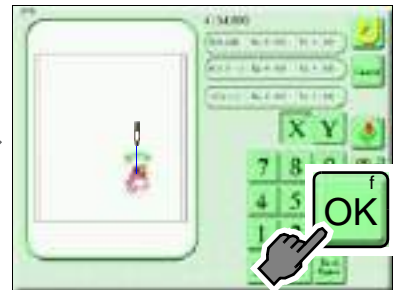

(14)Point 3

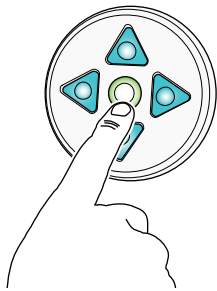

Move the frame to the point 3 by pressing the frame travel key.

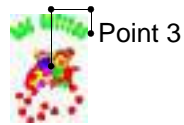

(15)OK

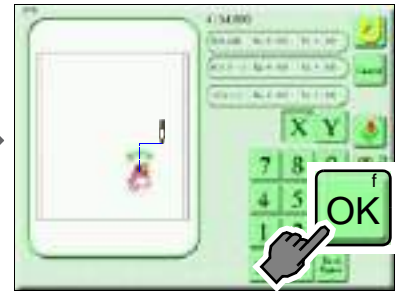

(16)To set



(17)5.0 (mm)



(18)To set (Completed)

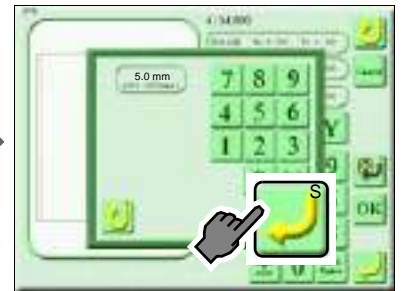

Chapter 8

Optional device



1. Sequin Device	130
2. Automatic Lubrication System	135

1. Sequin Device

1-1. To raise/lower all the Sequin devices of all heads at the same time

This function can be operated only when the needle bar equipped with the Sequin Device is selected.

! CAUTION

-  When performing this operation, keep your hands, face etc. away from the needle bar case. The moving Sequin Device could injure you.
-  Do not raise/lower the air cylinder and its related parts by hand. It could damage the Sequin Device.

About Sequin Device IV operation

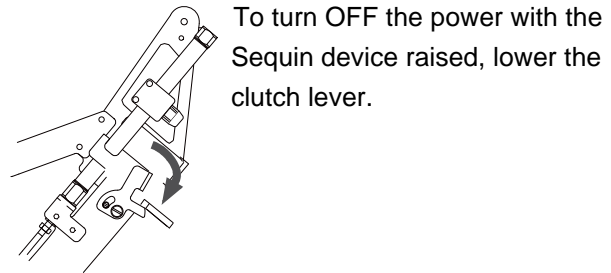
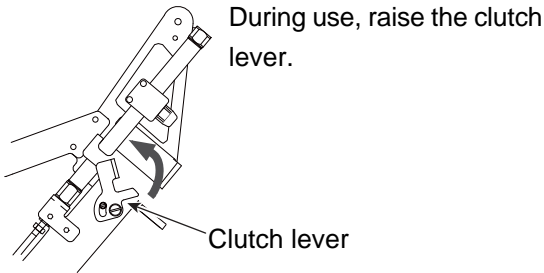

[How to operate]

Example: Lower the Sequin Device.

(1) Icon F

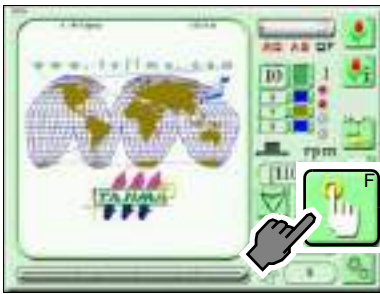

(2) Icon e



(3) Icon W



(4) Yes (Completed)

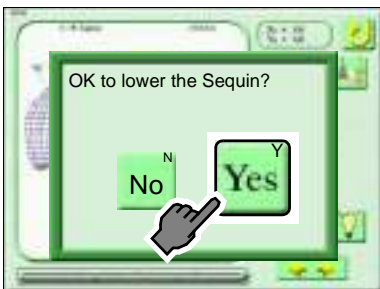

[How to operate]

Example: Raise the Sequin Device.

(1) Icon F

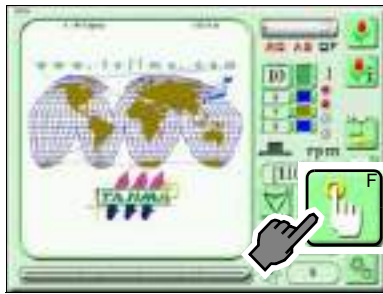

(2) Icon e



(3) Icon X



(4) Yes (Completed)

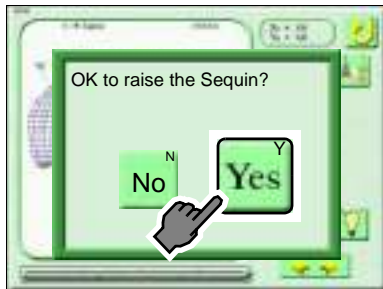

1-2. To raise/lower Sequin devices individually

This function supports ESQ-C only.

⚠ CAUTION

⊘ When performing this operation, keep your hands, face etc. away from the needle bar case. The moving Sequin Device could injure you.

Up/down switch

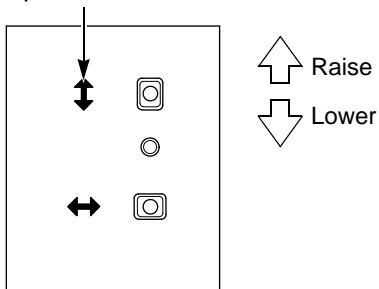

It is possible to operate only when the machine stops.

This function can be operated only when the needle bar equipped with the Sequin Device is selected.

Flipping the switch during raising/lowering will cause the device to stop.

1-3. To perform Color Change manually

This function supports ESQ-C only.

CAUTION

 When performing this operation, keep your hands, face etc. away from the needle bar case. The moving Sequin Device could injure you.

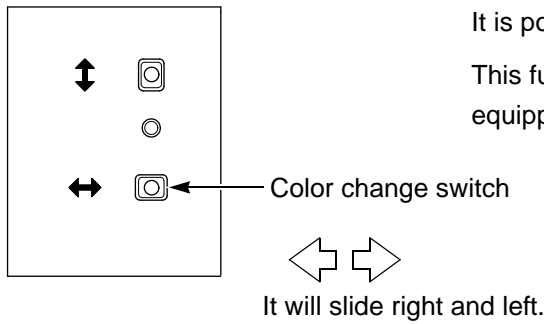

It is possible to operate only when the machine stops.
 This function can be operated only when the needle bar equipped with the Sequin Device is selected.

1-4. To replace Sequin 1 with Sequin 2 (Step unit)

Reverse Sequin 1 and Sequin 2 of the Sequin Device by step unit of needle bar. This function supports the Sequin Device III only.

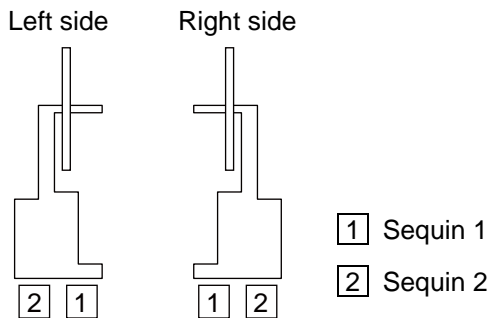

[How to operate]

Example: Reverse sequin embroidery of step 6 of the right side Sequin Device.



(4) Step 6

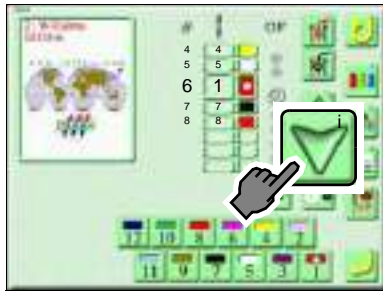

(5) Icon u

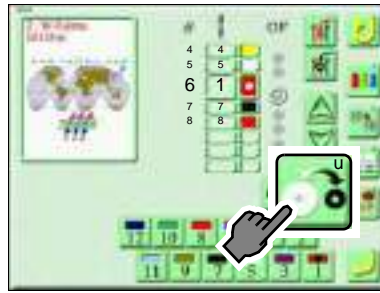

If icon u is pressed, the display of the needle bar icon of the 1st needle will be switched.

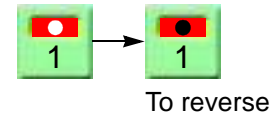

(6) Needle bar No. 1

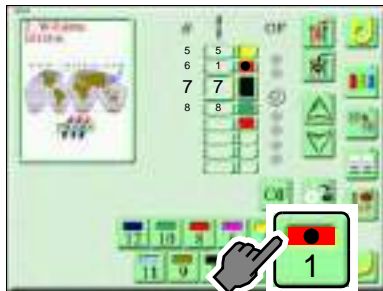

If the needle bar No.1 is pressed, step 6 will be switched on the display as shown below.

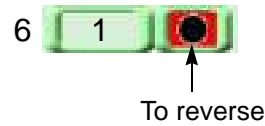

○ Not to reverse	Sequin 1 will be output by sequin output signal 1. Sequin 2 will be output by sequin output signal 2.
● To reverse	Sequin 2 will be output by sequin output signal 1. Sequin 1 will be output by sequin output signal 2.

(7) To set (Completed)

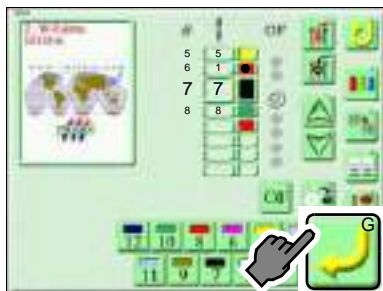

1-5. To replace Sequin 1 with Sequin 2 (Design data in a batch)

Reverse Sequin 1 and Sequin 2 of the Sequin Device together with the design data in a batch. After reversing, the design data will be overwritten. This function supports ESQ-C only.

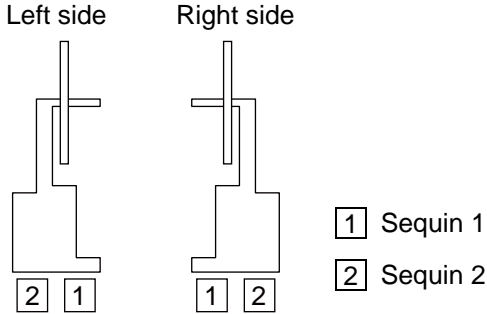

[How to operate]

Example: Reverse sequin embroidery of the right side Sequin Device in a batch.

(1) Icon A **(2) Design** **(3) Icon D**

(4) To set **(5) Icon S** **(6) Yes**

(7) To set (Completed)

After that, perform the data set for this design.

2. Automatic Lubrication System

2-1. To operate Lubrication System

While the machine is stopped, operate the lubrication system manually and lubricate to the rotary hook or the inside of head.

[How to operate]

(1) Icon F

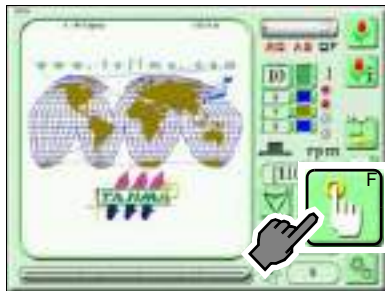

(2) Icon e



(3) Icon T



Type to lubricate the rotary hook and the inside the head.

(4) Icon d (Completed)

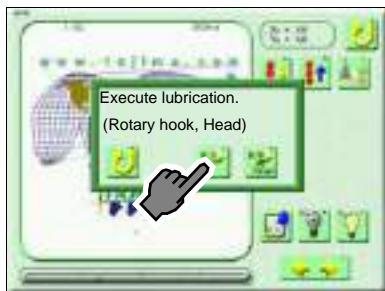

Lubricate the rotary hook.



Lubricate the rotary hook and the inside of head.

Type to lubricate the inside of head

(4) Icon d (Completed)

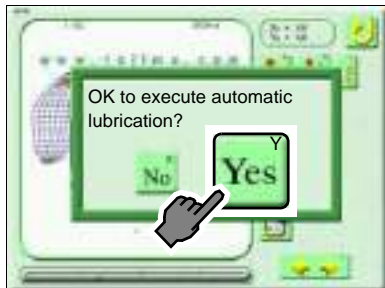

Chapter 9

Parameter (Setting item)

[Important]

About parameter display on the operation panel

All parameters are explained in this chapter. However, some parameters, which could affect embroidery quality if they are changed easily, are set to be hidden at shipment and they can not be changed.

To display or change them, input a password.

For details of the password, consult the distributor.

1. Display setting of parameter	138
2. Parameter	143



1. Display setting of parameter

This machine is shipped as the functional limit level "1". Display or hide parameters by the following operation according to the necessity of your use.

1-1. To hide all parameters

From the state of the functional limit level "1", we explain operating method hereafter.

(1) Icon G

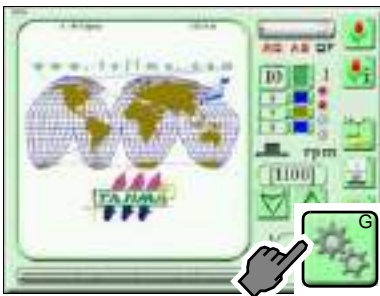

(2) Press P6 twice.

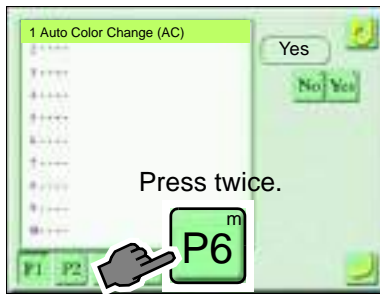

(3) Icon S

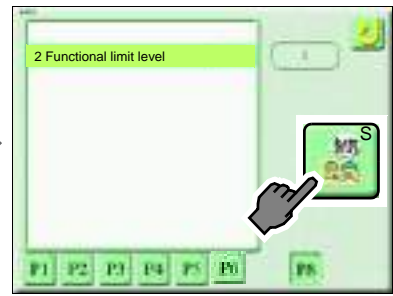

(4) Input a password.



(5) To set



(6) Functional Limit Level 2

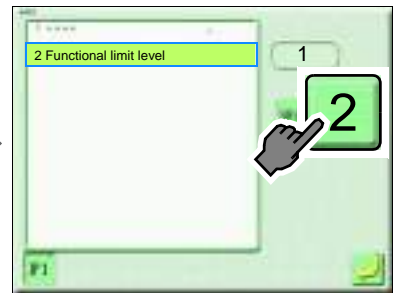

(7) To set

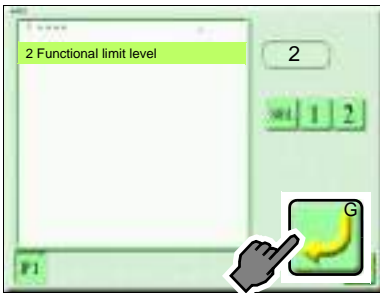

(8) Icon A (Completed)

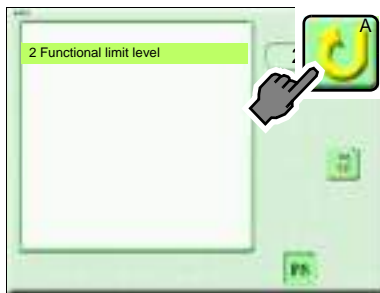



To display the desired parameter only.

1-2. To display the desired parameter only.

From the state of the functional limit level "1", we explain operating method hereafter.

[An example of operation]

You want to display only "1 Auto Color Change (AC)" and "2 Auto Start".

(1) Icon G

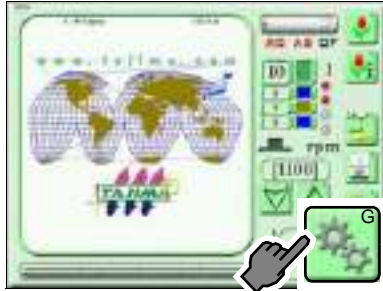

(2) Press P6 twice.

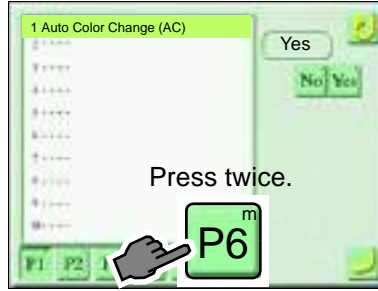

(3) Icon S

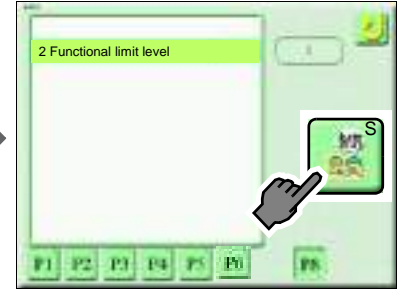

(4) Input a password.



(5) To set



(6) SEL

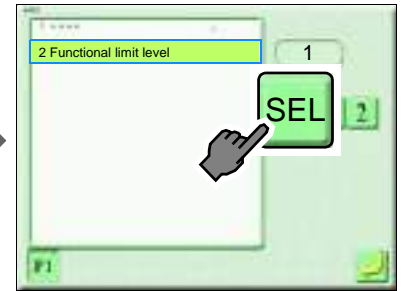

(7) Icon T

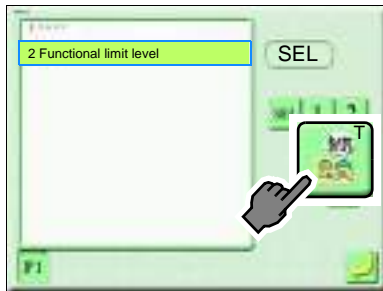

(8) ALL No

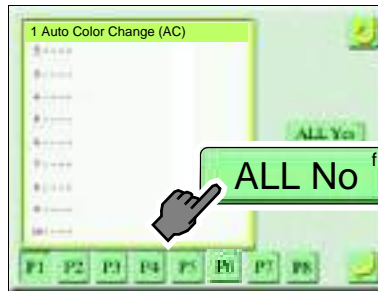

Outer frame turns yellow during setting level SEL.



(9) 1 Auto Color Change (AC)

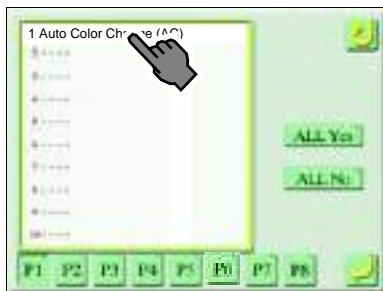

(10) 2 Auto Start (AS)

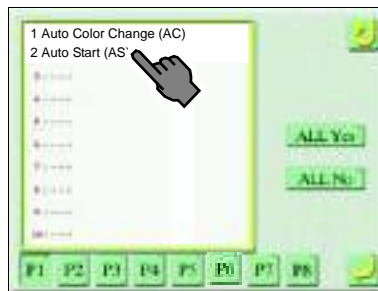

(11) To set

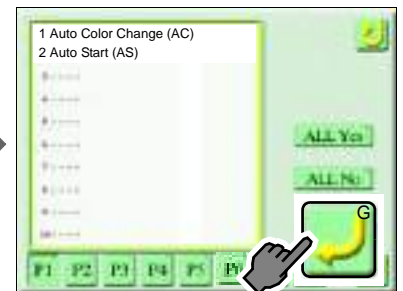



To hide the desired parameter only.

(12) To set

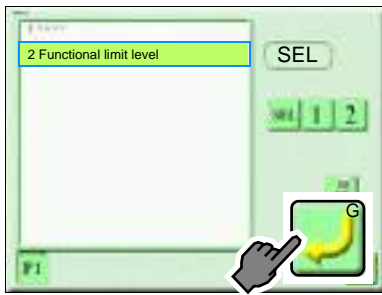

(13) Icon A (Completed)

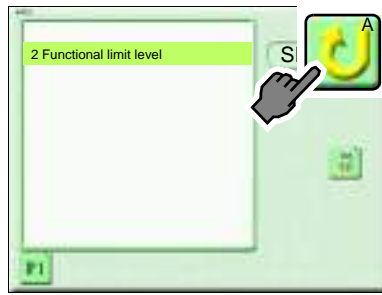

1-3. To hide the desired parameter only.

From the state of the functional limit level "1", we explain operating method hereafter.

[An example of operation]

You want to hide only "9 Auto Jump" and "10 Jump Convert".

(1) Icon G

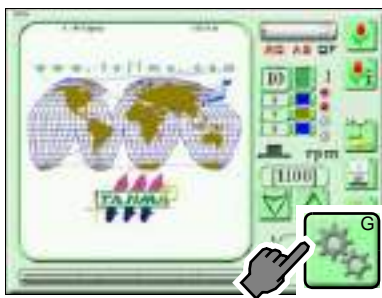

(2) Press P6 twice.

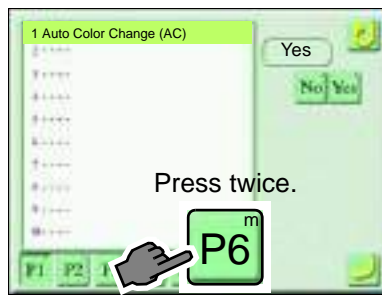

(3) Icon S

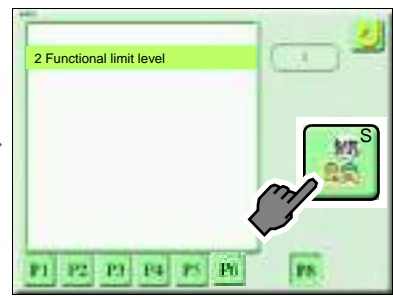

(4) Input a password.



(5) To set



(6) SEL

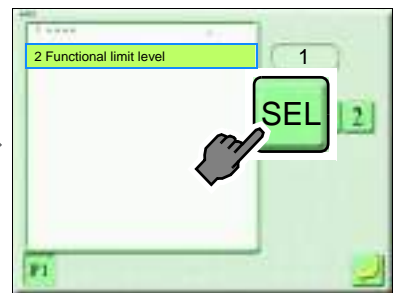

(7) Icon T

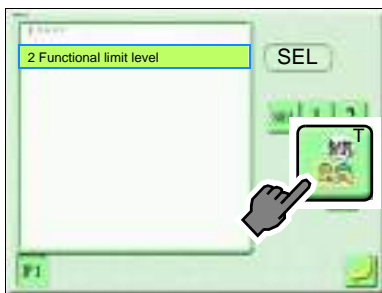

(8) ALL Yes

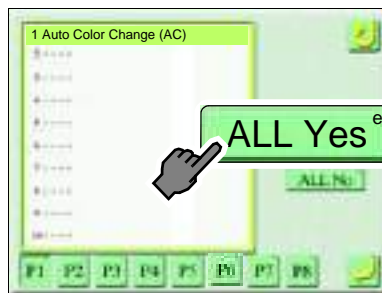

Outer frame turns yellow during setting level SEL.





To hide the desired parameter only.

(9) 9 Auto jump

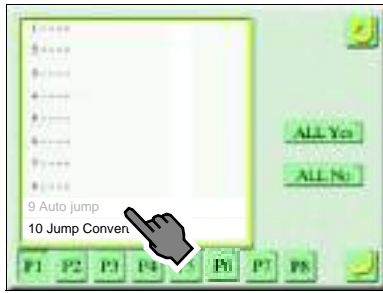

(10) 10 Jump Convert

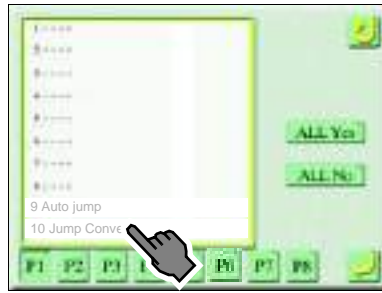

(11) To set



(12) To set

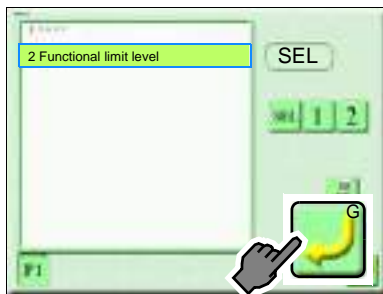

(13) Icon A (Completed)

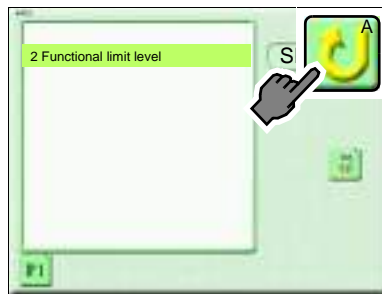



To display all parameters.

1-4. To display all parameters.

From the state of the functional limit level "1", we explain operating method hereafter.

(1) Icon G

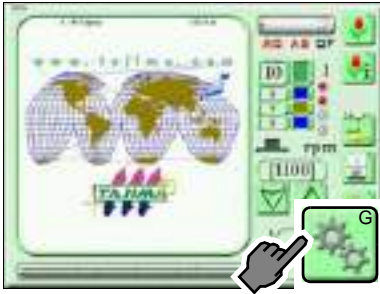

(2) Press P6 twice.

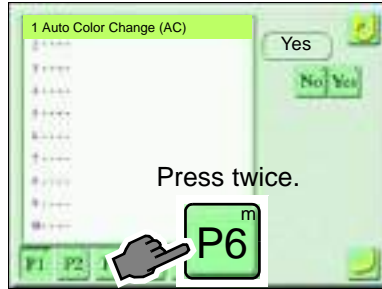

(3) Icon S

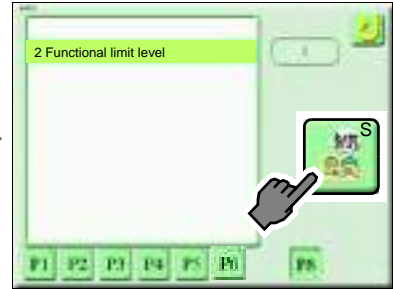

(4) Input a password.

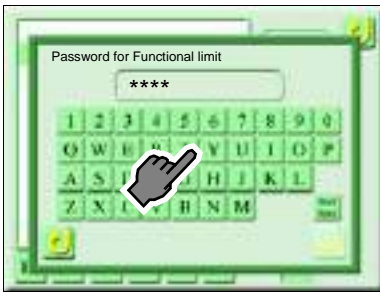

(5) To set



(6) SEL

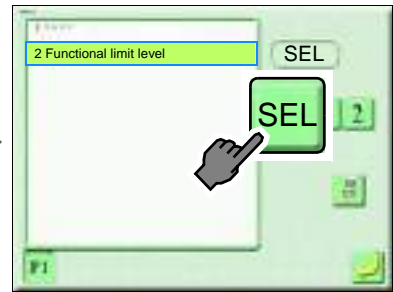

(7) Icon T

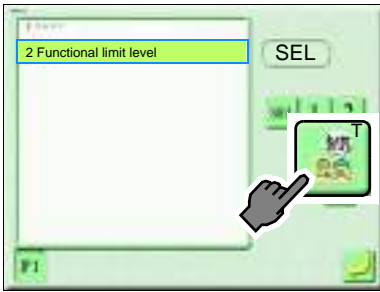

(8) ALL Yes

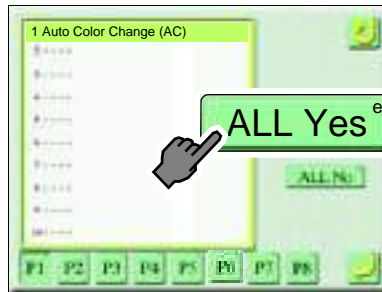

(9) To set

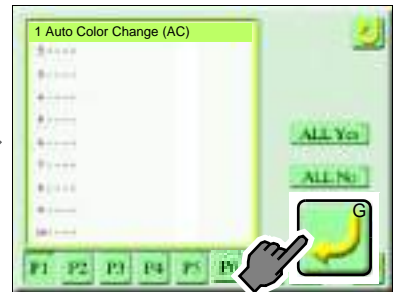

(10) To set

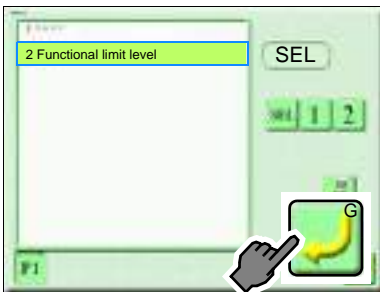

(11) Icon A (Completed)

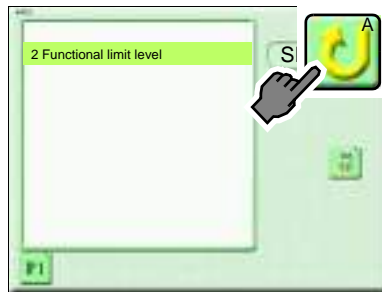



2. Parameter

2-1. Page P1

[How to switch to page P1]

(1) Icon G

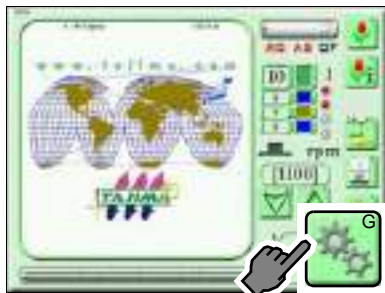

(2) Page P1



1 Auto Color Change (AC)

This is the setting to change the color automatically according to "Color change sequence".

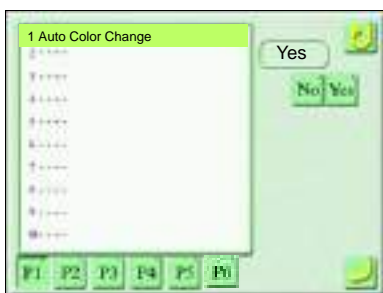

Setting range

Yes: Auto Color Change is performed.

No: Auto Color Change is not performed.

2 Auto Start (AS)

This is the setting to start the operation automatically after color change.

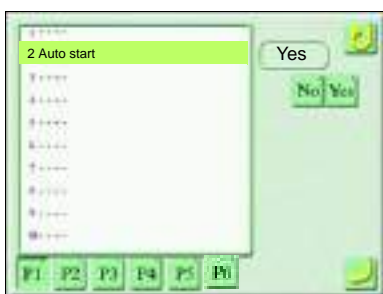

Setting range

Yes: Auto start is performed.

No: Auto start is not performed.

3 Auto start at same color

This is the setting to start the operation automatically even if the same needle bar is selected before and after color change.

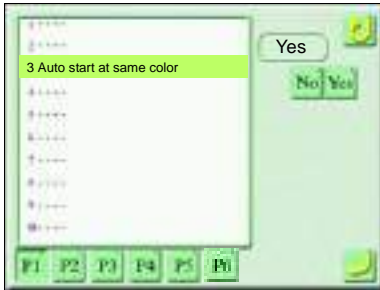

Setting range

Yes: Auto start is performed.

No: Auto start is not performed.

If "No" is selected, the machine will stop when the same needle bar is selected before and after color change. Therefore, it is effective for applique embroidery.

4 Auto Start after auto data set

! CAUTION

 After embroidery is finished, do not put your hands etc. on the table. Automatic start operation could injure you.

This is the setting to perform automatic start after finishing embroidery and embroider same design repeatedly.

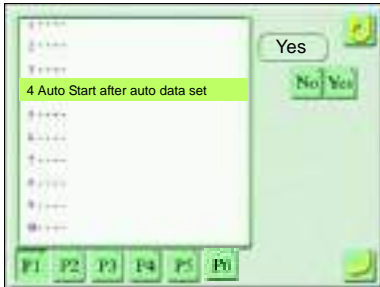

Setting range

Yes: Automatic start operation is performed after embroidery is finished.

No: Automatic start operation is not performed after embroidery is finished.

This function is effective for such a sock frame embroidery as changing sock frame one after another. Press "No" usually.

5 Frame type, FS mode

Set the frame type. Also set FS mode.(→p.197)

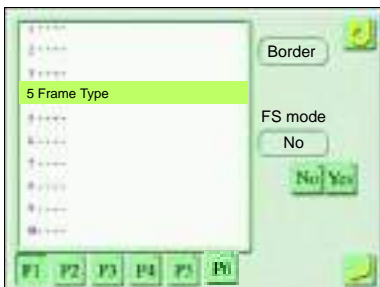

Setting range

Border frame only

FS mode

Yes: FS mode is set

No: FS mode is not set.

6 Total Stitch Counter

Display the number of stitches embroidered, the number of designs and remaining amount to Preset Halt from start of operation to now.



7 Start inching

After stopping the machine during embroidery, set the number of times of lowering the needle bar at slow operation performing when the operation starts again.

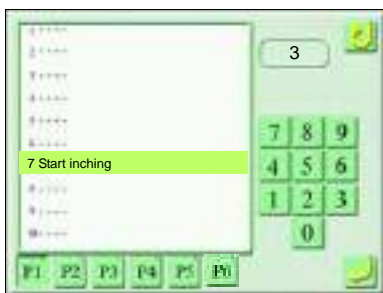

Setting range: 0 to 9 times

8 Inching after ATH

Set the times of lowering the needle bar by slow operation performed when starting operation again after data set and after thread trimming. It is possible to set by each needle bar.



Setting range

Any: All needles in a batch



Times of lowering needle bar (2 to 9)

Unit of needle bar

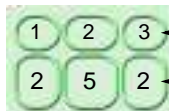

Needle bar No.

Times of lowering needle bar (2 to 9)

9 Auto jump

It is the setting to jump automatically when the stitch length is longer than the set value.

When the setting of Auto jump has been changed by "Step unit setting" individually, the value of "Step unit setting" will take the priority.



Setting range

No: Auto jump is not performed.

2.0 to 9.9 mm: Automatic jump is performed.

A: Split auto jump

10 Jump Convert

This is the setting to trim thread and move the frame to next stitch when jump codes continue more than the set times,

When the setting of Jump convert has been changed by "Step unit setting" individually, the value of "Step unit setting" will take the priority.

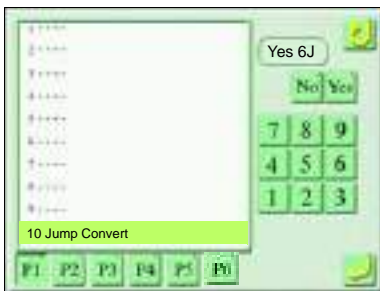

Setting range

Yes: Jump convert is performed . (1 to 9 times)

No: Jump convert is not performed.

2-2. Page P2

[How to switch to page P2]

(1) Icon G

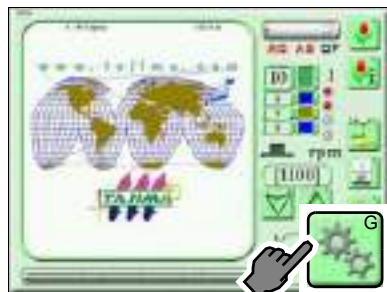

(2) P2

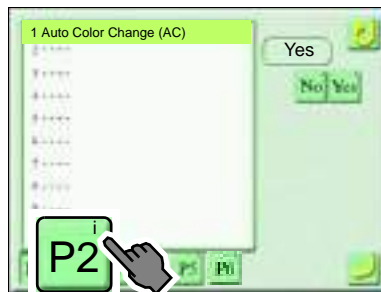

(3) Page P2

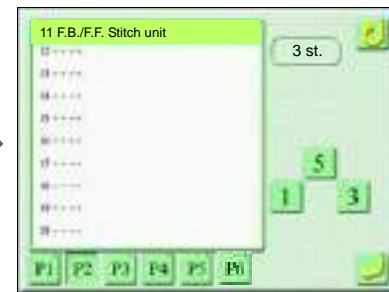

11 F.B./F.F. Stitch unit

Set frame feed amount when performing Frame back or Frame forward by 11 stitches or more.



Setting range: 1, 3, 5 stitches

12 Auto F.B. after T. detection

This is the setting to perform Frame Back automatically at thread breakage.

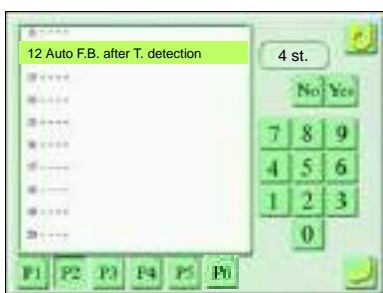

Setting range

Yes: Auto F.B. is performed.

0 to 9: Number of stitches performing Frame Back

No: Auto F.B. is not performed.

The number of stitches to perform Frame Back is the total of this value and the value of "26. Upper thread detection" or "27. Under thread detection (unit)" of page P3 based on the stop point of the machine.

13 Overlap Frame Back

Set a start position of embroidering at all heads after Frame back.

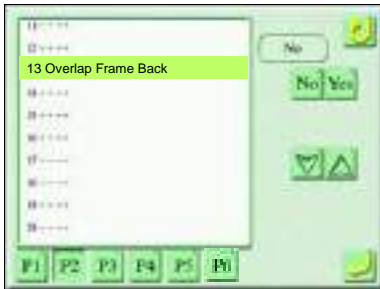

Setting range

Yes: All heads start embroidery.

If "Yes" is selected, set All Head Sewing Start Point.

- 1: All heads start embroidering from the position where is one stitch prior to the start position of Frame back.
- 2: All heads start embroidering from the position where is two stitches prior to the start position of Frame back.

3 to 9:

All heads start embroidering from the position where is 3 to 9 stitches prior to the start position of Frame back.

Whole area: Embroider at whole area of Frame back section by all heads.

No: Overlap frame back at all heads is not performed.

14 Halt before F.B./inching

Set a starting method to start embroidering at all heads after Frame back.

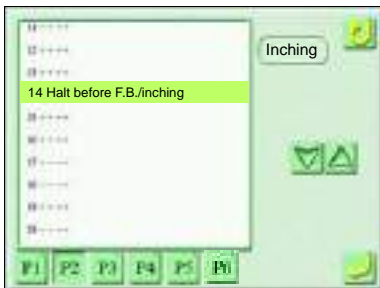

Setting range

Inching: Lower to the start inching r.p.m.

Stop: Stop at the position where all heads start embroidering

15 R.P.M. limit by needle position

Set the maximum speed by all needles in a batch or by needle bar unit. When Sequin device is equipped, set the maximum speed of Sequin device.

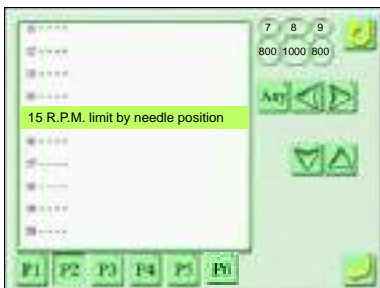

Setting range

Any: All needles in a batch

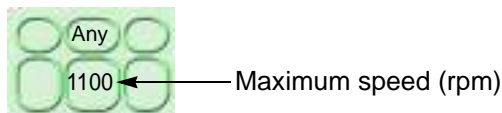

Unit of needle bar

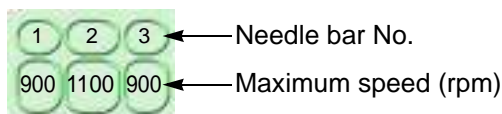

2-3. Page P3

[How to switch to page P3]

(1) Icon G

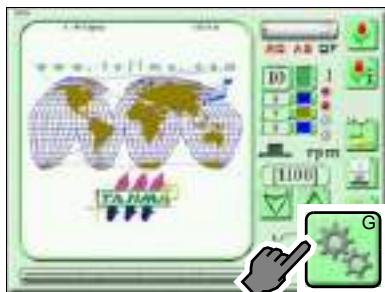

(2) P3

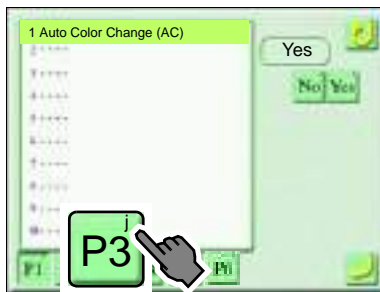

(3) Page P3

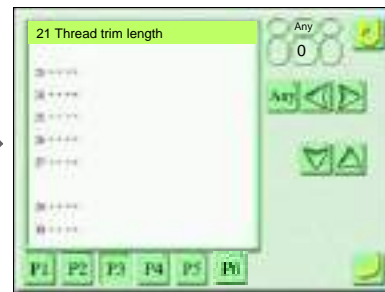

21 Thread trim length

Adjust the remaining length of the upper thread after thread trimming by all needles in a batch or by needle bar unit.

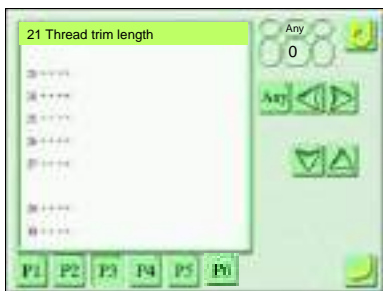

Setting range

Any: All needles in a batch

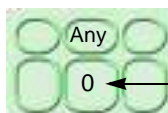

Thread trim length (-2, -1, 0, 1, 2)

Unit of needle bar

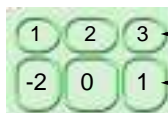

Needle bar No.

Thread trim length (-2, -1, 0, 1, 2)

-2, -1, 0, 1, 2

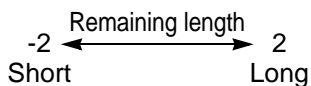

23 Sewing start return stitch

Set the number and the stitch length of Return stitches to be executed at start of embroidery by all needles in a batch or by unit of needle bar.

When the setting of Return stitches has been changed by "Step unit setting" individually, the value of "Step unit setting" will take the priority.

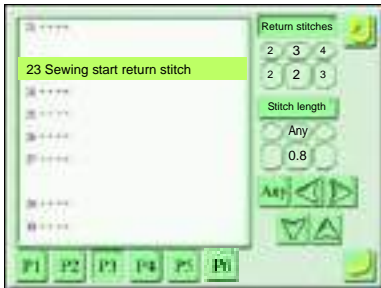

Setting range

Return Stitch at Start Sewing

Any: All needles in a batch

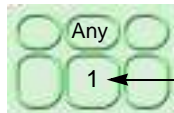

Number of Return stitches (0, 1, 2, T0, T1, T2)

Unit of needle bar

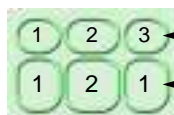

Needle bar No.

Number of Return stitches (0, 1, 2, T0, T1, T2)

0: Without Return Stitches

Stitch at start of sewin



1: One reciprocation

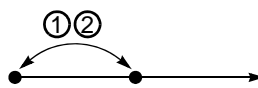

2: Two reciprocations

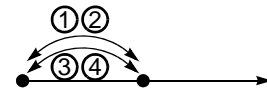

T0: Triangle

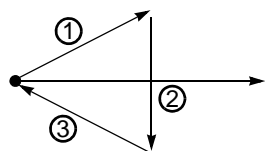

T1: Triangle + one reciprocation

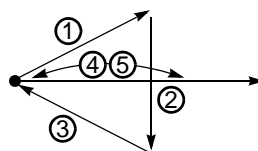

T2: Triangle + two reciprocations

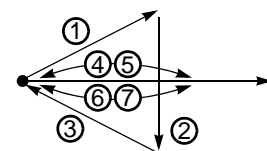

Stitch length

Any: All needles in a batch



Stitch length (0.6, 0.8, 1.0, 1.2, 1.6, 2.0 mm)

Unit of needle bar

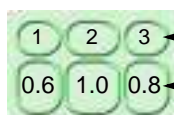

Needle bar No.

Stitch length (0.6, 0.8, 1.0, 1.2, 1.6, 2.0 mm)



24 Tie stitches

Set the pattern and the stitch length of Tie stitches to be executed before thread trimming by all needles in a batch or by unit of needle bar.

When the setting of Tie stitches has been changed by "Step unit setting" individually, the value of "Step unit setting" will take the priority.

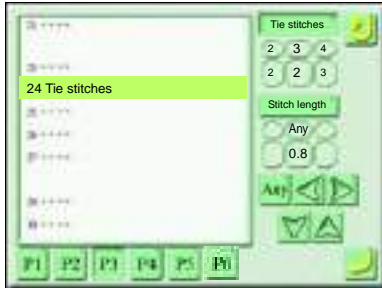

Setting range

Tie stitches

Any: All needles in a batch

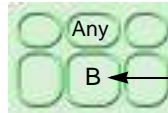

Tie stitches (A, B, C, D, E)

Unit of needle bar



Needle bar No.

Tie stitches (A, B, C, D, E)

A to E: Tie stitching methods

- A: Tie stitching is not performed.
- B: Tie stitching is performed.
- C: After embroidering 2 stitches at the same place, tie stitching will be performed.
- D: Perform one reciprocation of tie stitches.
- E: B and D are switched to the direction of Tie stitches.

Stitch length

Any: All needles in a batch

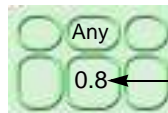

Stitch length

Unit of needle bar

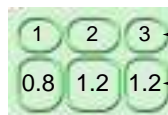

Needle bar No.

Stitch length

0.4, 0.6, 0.8, 1.0, 1.2, 1.6, 2.0 (mm)

25 Upper thread lock timing

Set the remaining length of the upper thread at start of embroidery (Release) and at thread trimming (Lock).

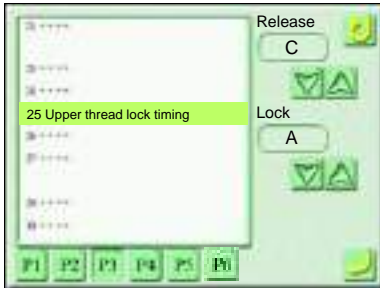

Setting range

Release: A, B, C

Lock: A, B, C

- A ↓ Upper thread is easy to remain
- B ↓
- C ↓ Upper thread is hard to remain

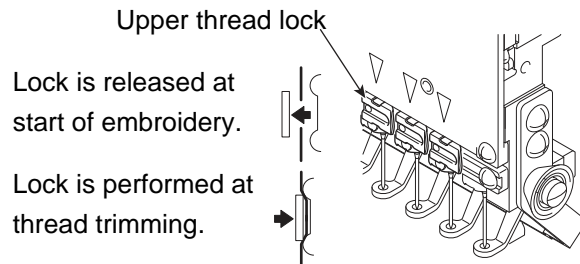

26 Upper thread detection

Set the sensitivity of detection when the thread breaks by all needles in a batch or by needle bar unit. When the setting of Thread breakage detection has been changed by "Step unit setting" individually, the value of "Step unit setting" will take the priority.

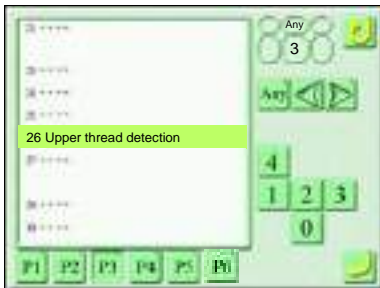

Setting range

Any: All needles in a batch

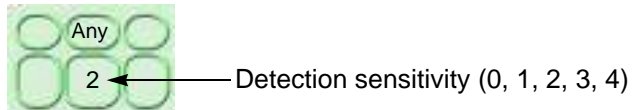

Unit of needle bar

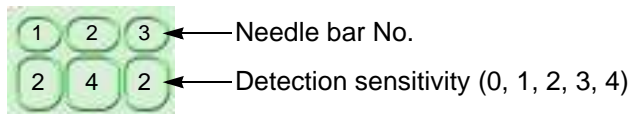

"0" does not detect thread breakage. The machine does not stop even if thread breakage occurs.

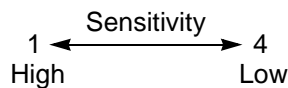

If the detection sensitivity is set to "3", the machine will stop working when detecting thread breakage three times consecutively.

27 Under thread detection

(1) Unit

Set how many consecutive times of detecting of "Step ratio" described later are regarded as thread breakage by all needles in a batch or by needle bar unit.

When the setting of Thread breakage detection has been changed by "Step unit setting" individually, the value of "Step unit setting" will take the priority.



Setting range

Any: All needles in a batch

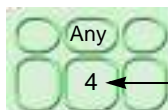

Detection sensitivity (0, 2, 4, 6, 8)

Unit of needle bar

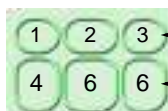

Needle bar No.

Detection sensitivity (0, 2, 4, 6, 8)

"0" does not detect thread breakage. The machine does not stop even if thread breakage occurs.

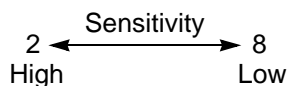

(2) Step ratio

Set the detection sensitivity of the under thread breakage by all needles in a batch or by needle bar unit.

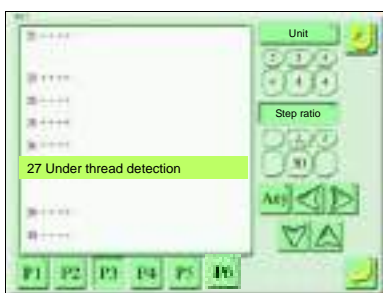

Setting range

Any: All needles in a batch



Detection ratio
(30, 40, 50, 60, 70, 80, 90, 100%)

Unit of needle bar

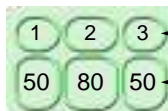

Needle bar No.

Detection ratio
(30, 40, 50, 60, 70, 80, 90, 100%)

Detection ratio (%)

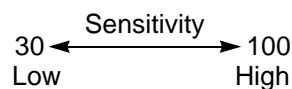

29 Auto origin return

This is the setting to return the frame to start position after embroidery is finished.

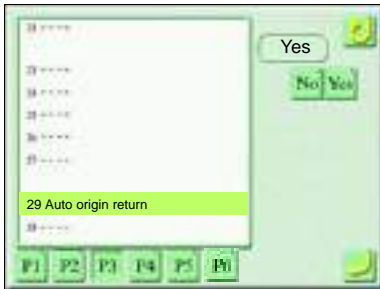

Setting range

Yes: Return to the start position.

No: Start position is not returned.

30 Return the frame after manual frame travel

This is the setting to return the frame to the previous position by the bar switch or the start switch operation after moving the frame during embroidery.

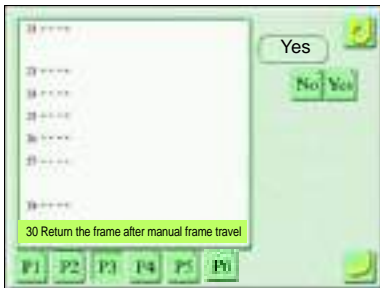

Setting range

Yes: The frame is returned to previous position.

No: The frame is not returned to previous position.

If "No" is selected, "Automatic data point return" will be invalid. In this case, the frame will not return and the embroidery will be started from the position after the frame moving by switch operation.



2-4. Page P4

[How to switch to page P4]

(1) Icon G

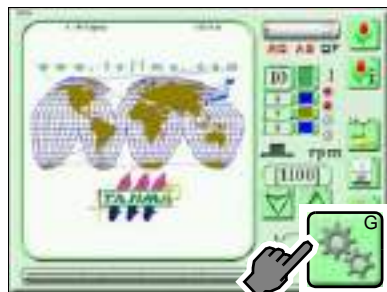

(2) P4

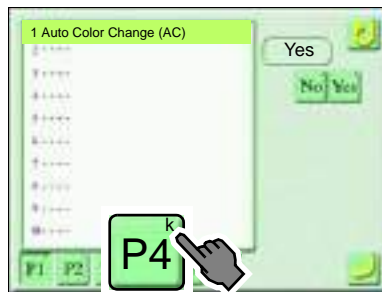

(3) Page P4

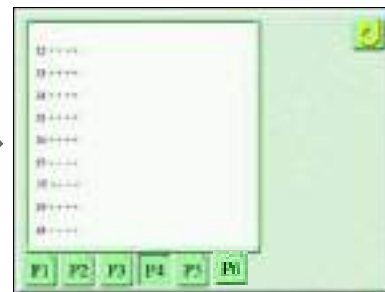

32 Language

Switch the language display of screen.

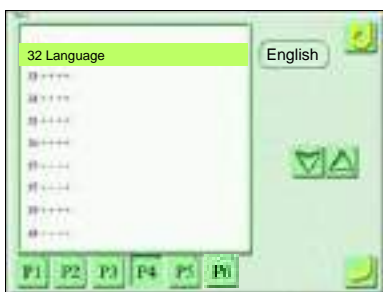

33 Preset Halt by stitches

This is the setting to stop the machine automatically when the number of stitches are reached to setting value.



Setting range: 0 to 999,999 stitches

After stop, "1D2" will be displayed.

34 Preset Halt by Data

This is the setting to make the machine to stop automatically when the cumulative amount of frame travel is reached to setting value.



Setting range: 0 to 99,999 cm

After stop, "1D2" will be displayed.

35 Preset Halt by Designs

This is the setting to make the machine to stop automatically when the cumulative number of embroidery designs is reached.



Setting range: 0 to 999 designs

After stop, "1D2" will be displayed.

36 Preset Halt by Lubrication

This is the setting to stop the machine automatically when the main shaft r.p.m. reached the setting value.

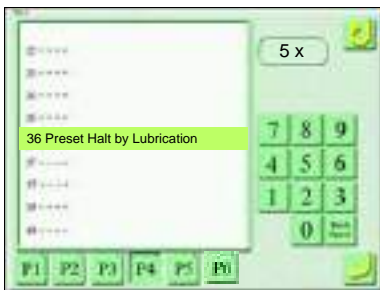

Setting range: 0 to 990,000 rpm

The setting value x 10,000 is the number of main shaft revolution to be stopped. After the stop, "OIL" is indicated. It is effective only when "9 Automatic lubrication system" of P7 page is set to "No".

37 Preset halt (1st before end code)

This is the setting to stop the machine automatically at the position where one stitch before embroidering end.

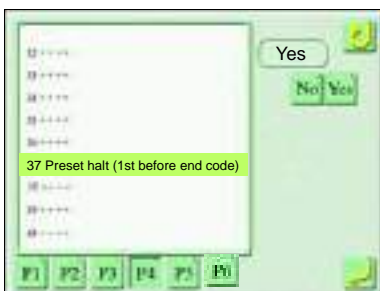

Setting range

Yes: Automatic stop is performed.

After stop, "1D2" will be displayed on the operation panel.

No: Automatic stop is not performed.

If "Yes" is selected, it is possible to perform frame back after stop of the machine.

38 Table Offset Position

Register Table Offset Position.



Setting range: Embroidery space

Example: Register Table Offset Position.



Frame Travel

39 Optional position

Register the desired frame position.

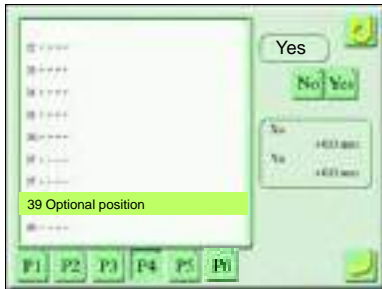

Setting range: Embroidery space

Example: Register the frame position.

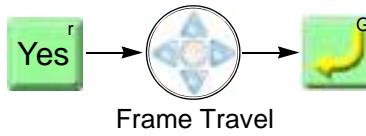

If "Yes" is selected, X/Y coordinates from frame origin will be displayed.

40 Needle Bar Color

Color the design on the operation panel according to the color of thread to use actually.

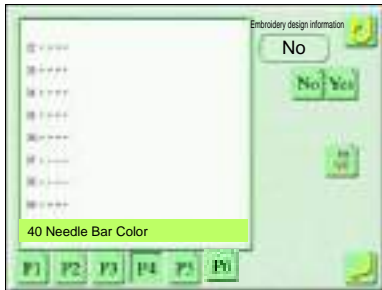

Setting range

Yes: The color is set to the setting color when making design.

No: A color is selected in the palette.

Example: Change 8th needle to red.

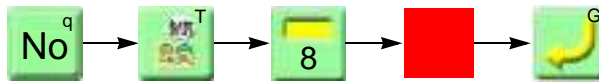

Select a color in the palette.



2-5. Page P5

[How to switch to page P5]

(1) Icon G

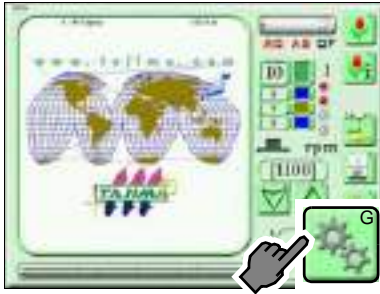

(2) P5

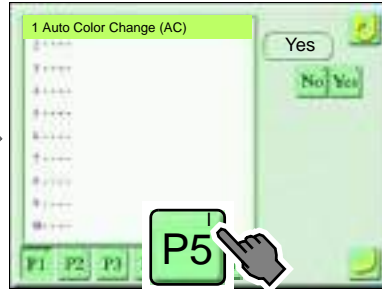

(3) Page P5

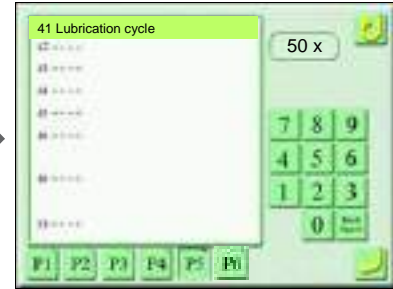

41 Lubrication cycle

Set the cycle (number of stitches) that Automatic lubrication system will lubricate the rotary hook.

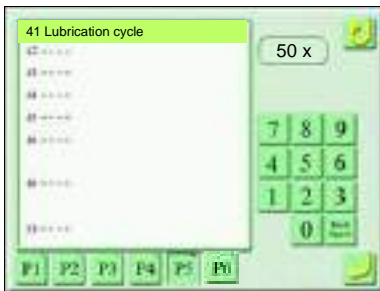

Setting range: 0 to 9,999 (x 1,000 stitches)

42 Lubrication cycle (Head)

Set the cycle (number of stitches) that Automatic lubrication system will lubricate to the inside of the head.

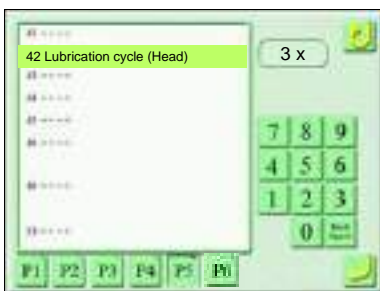

Setting range : 0 to 100 (X41 Lubrication cycle)

43 Sequin feed amount (R)

Set sequin feed amount of Sequin Device at the right side.

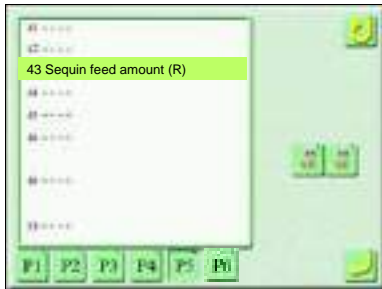

Setting range

ESQ-C: 3.0 to 9.9 mm

SQ4: 3.0 to 23.0 mm

The left figure is an display example when the type of sequin is "ESQ-C".(→p.170)

Icon S will not be displayed in case of "SQ4".

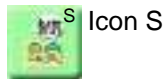

Example:

Set the sequin feed amount of Sequin 1 of the Sequin Device ESQ-C to 5.0 mm.

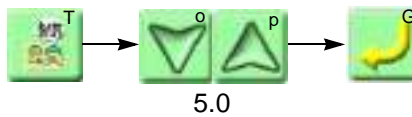

Icon T
 Sequin 1

Icon S
 Sequin 2

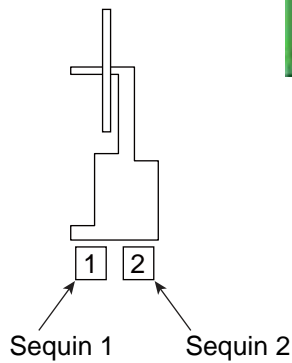

Rough standard of sequin feed amount is +1.0 mm for sequin size.

According to the feed amount, the maximum speed of the machine will change.

44 Sequin feed amount (L)

Set sequin feed amount of Sequin Device at the left side.

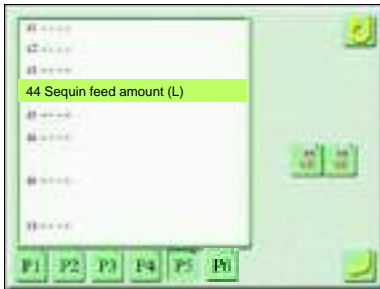

Setting range

ESQ-C: 3.0 to 9.9 mm

SQ4: 3.0 to 23.0 mm

The left figure is an display example when the type of sequin is "ESQ-C". (→p.171)

Icon S will not be displayed in case of "SQ4".

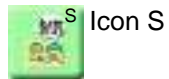

Example:

Set the sequin feed amount of Sequin 1 of the Sequin Device ESQ-C to 5.0 mm.

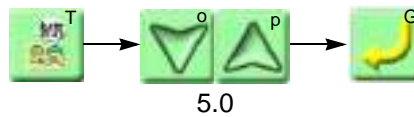

Icon T
Sequin 1

Icon S
Sequin 2

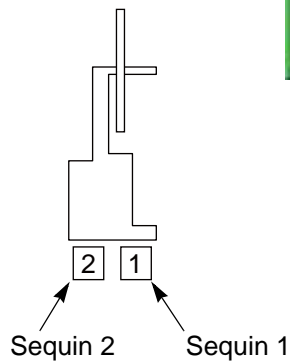
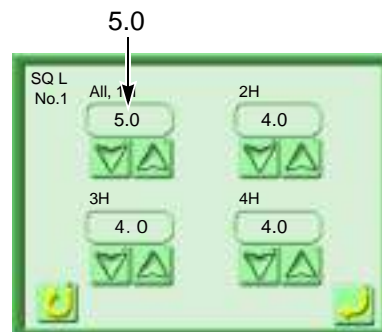

Rough standard of sequin feed amount is +1.0 mm for sequin size.

According to the feed amount, the maximum speed of the machine will change.

45 Auto lifting - Sequin device

Set to raise/not to raise Sequin device at frame stepping, at thread breakage or when sequin chip runs out.

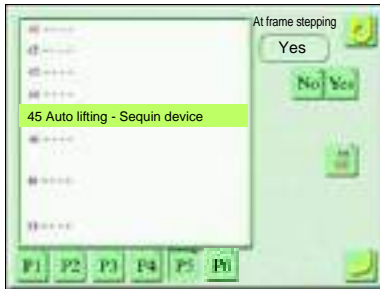

Setting range

Frame stepping

Yes: Move up Sequin device at frame stepping.

No: Do not move up Sequin device at frame stepping.

Thread breakage (ESQ-C only)

Yes: Sequin device is raised at thread breakage.

No: Sequin device is not raised at thread breakage.

Running out of material (ESQ-C only)

Yes: When sequin runs out, Sequin device is moved up.

No: When sequin runs out, Sequin device is not moved up.

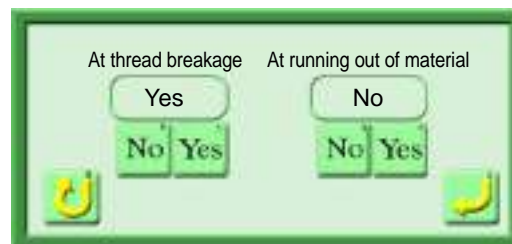

Icon T is displayed only when ESQ-C is set.



46 Boring step

Set Frame Movement at Boring step.

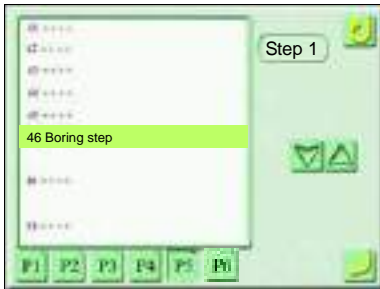

Setting range

Step 1: Data processing should not be performed. Do not perform Data Conversion at Step 1.

Step 2: Delete the frame travel data in the design data, and generate the frame travel data in the machine.

Step 3: Generate the frame travel data in the machine.

Without:

Boring is not performed.

Select Step 1 or Step 2 if there is a frame travel data (12 mm) in the design. Select Step 3 if there is not any frame travel data.

50 Detailed Network information

It is possible to check the setting state of Network.

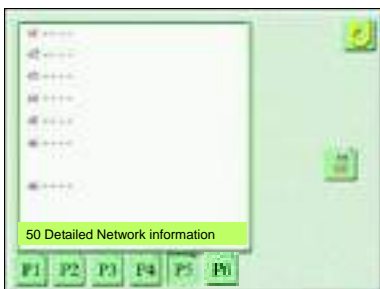

How to check



2-6. Page P7

To change the parameter explained in page P7, it is necessary to input a password. For details, consult the distributor.

[How to switch to page P7]

(1) Icon G

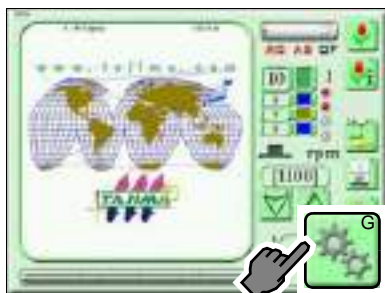

(2) Press P6 twice.

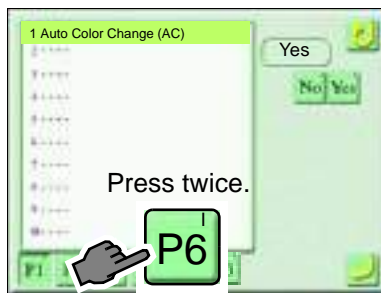

(3) Icon S

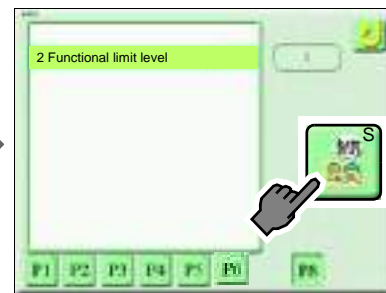

(4) Input a password.

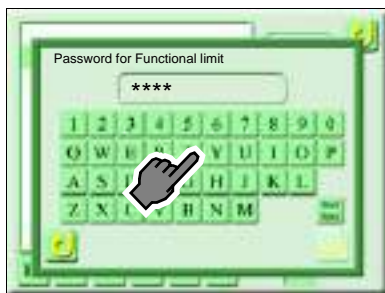

(5) To set

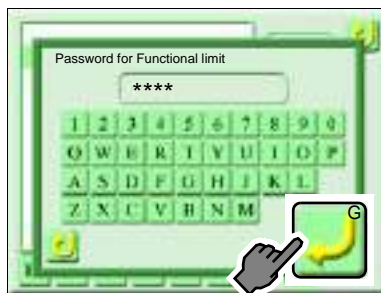

(6) SEL

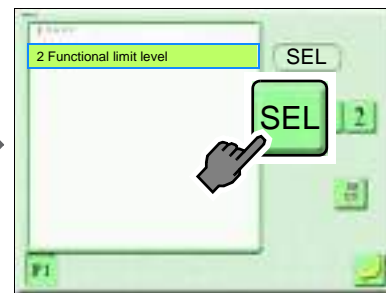

(7) Icon T

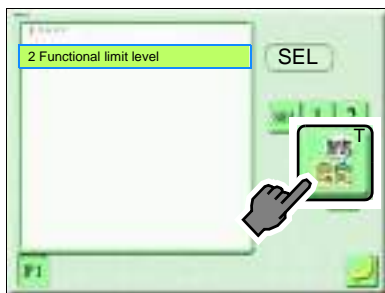

(8) ALL Yes

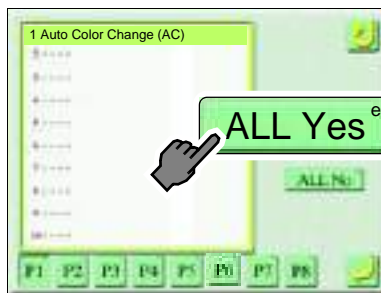

(9) To set

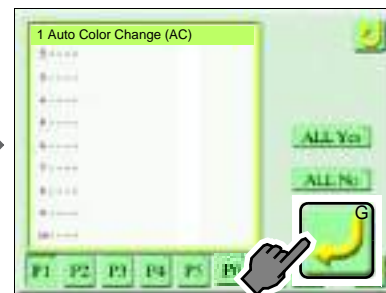

(10) To set

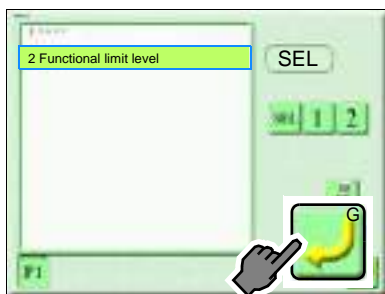

(11) Icon A

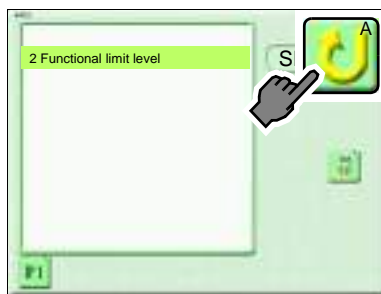

(12) P7

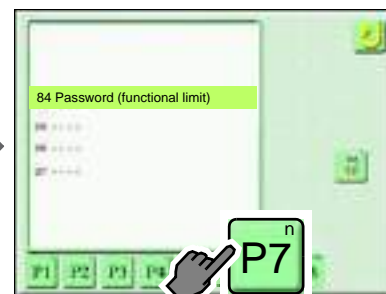

(13)Page P7

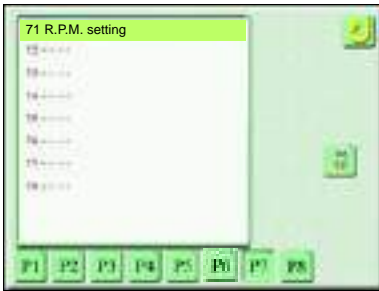

[71 R.P.M. setting]

1 Speed change data

Set a stitch length that switches from high speed to low speed.

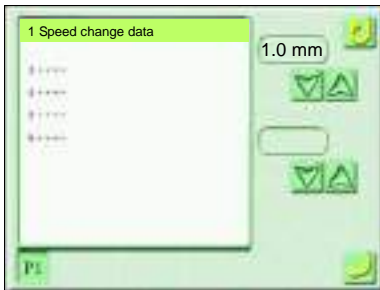

Setting range: 1.0 to 4.0 mm

2 Low speed r.p.m. / Low speed code r.p.m. (Input of a password is necessary)

Set the embroidery speed (low speed R.P.M.) decreased by stitch length and the embroidery speed (Low speed code R.P.M.) in the low speed code section.

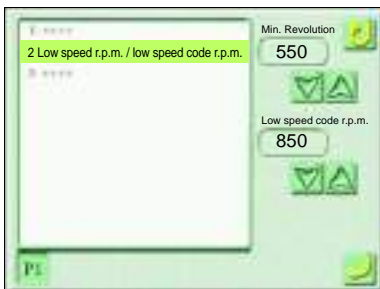

Setting range

Low speed r.p.m.: 250 to 600 rpm

Low speed code r.p.m.: 250 to Maximum r.p.m. of machine

3 Start/ATH inching r.p.m. (Input of a password is necessary)

Start inching r.p.m.

After data set or after thread trimming, set the start inching r.p.m. after stopping the machine in the middle of embroidery

ATH Inchings

Set ATH inching r.p.m. before thread breakage.

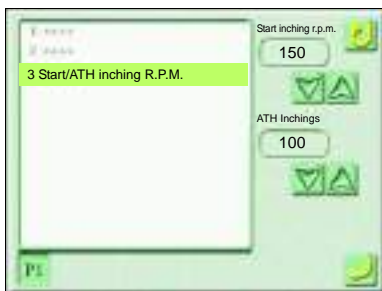

Setting range

Start inching r.p.m.: 100, 150, 200, 250 rpm

ATH Inchings: 100, 150, 200 rpm

[72 Stitch Compensation]

1 Backlash (X) (Input of a password is necessary)

Correct driving error of the frame generated when a stitch turns back in horizontal direction.

When the setting of Backlash has been changed by "Step unit setting" individually, the value of "Step unit setting" will take the priority.

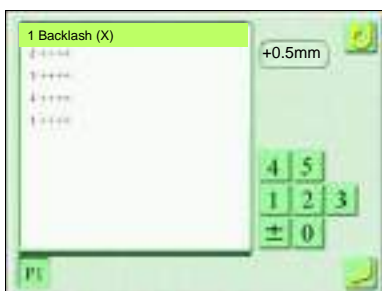

Setting range: -0.5 to +0.5 mm

If the value is input, the setting of Satin stitch will be invalid.

2 Backlash (Y) (Input of a password is necessary)

Correct driving error of the frame generated when a stitch turns back in vertical direction.

When the setting of Backlash has been changed by "Step unit setting" individually, the value of "Step unit setting" will take the priority.

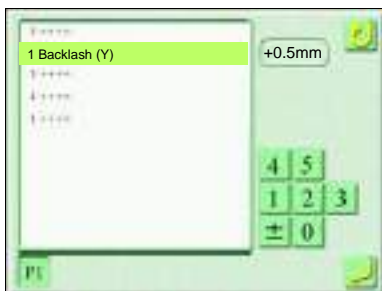

Setting range: -0.5 to +0.5 mm

If the value is input, the setting of Satin stitch will be invalid.

3 Satin Stitch (area) (Input of a password is necessary)

Set a target range of Satin Stitch (Expansion).

When the setting of Satin stitch (area) has been changed by "Step unit setting" individually, the value of "Step unit setting" will take the priority.



Setting range

Whole: All Satin stitches in design

Part: Function code "Satin stitch" section

No: It is not added.

4 Satin Stitch (density) (Input of a password is necessary)

Set stitch length (a in the figure below) that is regarded as Satin stitch. Stitches of the setting value or less will be regarded as Satin stitch.

When the setting of Satin stitch (density) has been changed by "Step unit setting" individually, the value of "Step unit setting" will take the priority.

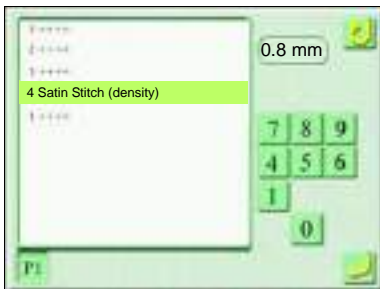

Setting range: 0.4 to 1.0 mm

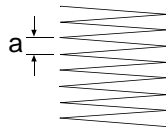

It is effective when "3. Satin Stitch (Area)" is set to "Whole" or "Part".

5 Satin Stitch (Expansion) (Input of a password is necessary)

This setting sets up an adding amount to a stitch that was judged as Satin stitch in above 4 Satin stitch (density). 1/2 (b) of the set value will be added to both sides of the stitch (c) respectively.

When the setting of Satin Stitch (Expansion) has been changed by "Step unit setting" individually, the value of "Step unit setting" will take the priority.



Setting range: -1.0 to +1.0 mm

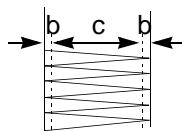

[73 Design Setting]

2 Condition data (Input of a password is necessary)

When you register the design saved in the USB memory into the machine memory, set whether the condition data (Color change sequence, Start position) are registered together with the design into the machine memory or not.(→p.192)

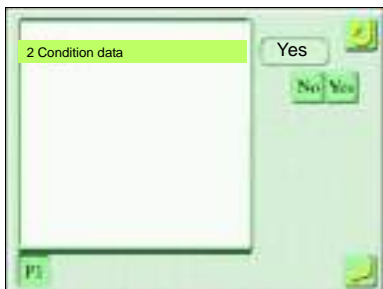

Setting range

Yes: It will be registered into the machine memory.

No: It will not be registered into the machine memory.

[74 Frame Setting]

3 Frame weight (Input of a password is necessary)

In the registration of frame weight level, set whether to use or not use the square frame.

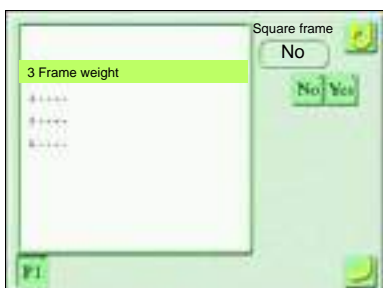

Setting range

Yes: Register frame weight level using square frame.

No: Register frame weight level not using square frame.

It is effective only for models registered with frame weight level of square frame.

4 Frame Travel Speed, Frame Stepping Method (Input of a password is necessary)

Set the frame travel speed and the frame stepping method at frame stepping.

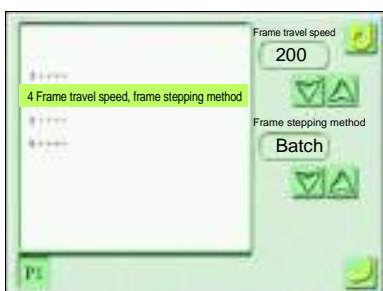

Setting range

Frame travel speed: 100, 200 mm/second

Frame stepping method: Batch, 1 stitch

Batch: Perform frame travel directly to frame stepping point.

By 1 stitch: Perform frame travel stitch by stitch as design data.

5 Frame start timing(Input of a password is necessary)

CAUTION

! When changing the value, consult the distributor. Some operating condition could cause occurrence of bad effect in embroidery.

Set the main shaft angle where the frame starts moving.

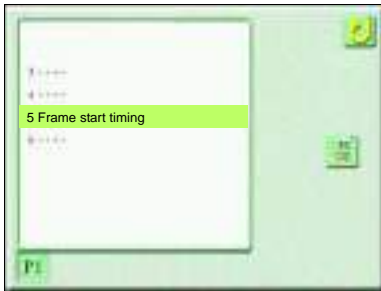

Setting range
 -30 to +30: Frame start timing

← -30
+30 →

Fast
Slow

[Thread tension] Loose
[Thread tension] Tight

[Stitch length] Narrow

6 Frame start timing (FS mode) (Input of a password is necessary)

At FS mode, set the main shaft angle where the frame starts moving.

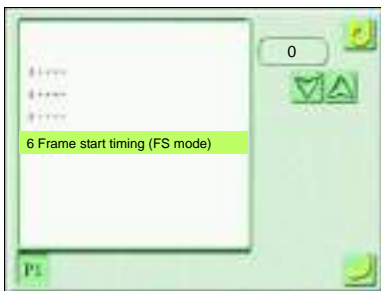

Setting range
 -20, 0:Frame drive timing

[75 ATH Setting]

1 ATH (Input of a password is necessary)

This is the setting to trim the thread automatically at Color change, Frame stepping and Offset frame travel.

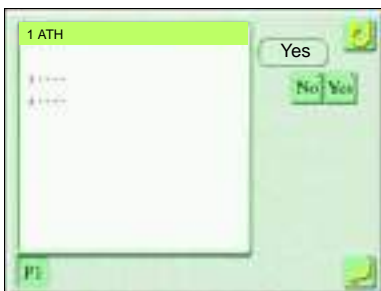

Setting range
 Yes: ATH is performed.
 No: ATH is not performed.

3 Sensitivity of ATH error detection (Input of a password is necessary)

Set the sensitivity of ATH error detection after thread trimming.

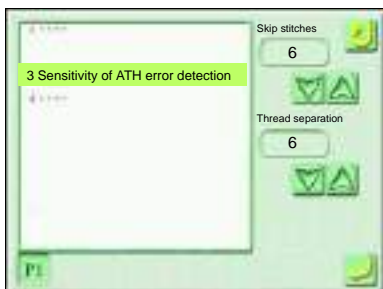

Setting range

Skip stitches (It will not be detected by cam type ATH.)

0: Do not detect error.

1 to 50: Detect.

Select the value of 1 to 50.

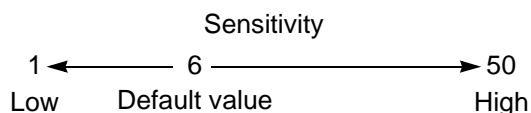

This is the detection sensitivity to make the machine judges that the thread is not broken due to skip stitches at thread trimming. The machine will stop at the detection, and the code No.3AC will be displayed.

Thread separation

0: Do not detect.

1 to 50: Detect.

Select the value of 6 or more.

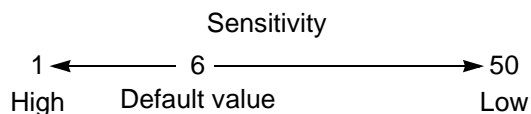

This is the detection sensitivity to make the machine judges that the thread is not broken due to thread separation of the movable knife at thread trimming. The machine will stop at the detection, and the code No.3AB will be displayed.

4 Under-thread opening operation (Input of a password is necessary)

It is the setting for releasing the under thread forcibly in order to reduce thread entanglement at the start of sewing.

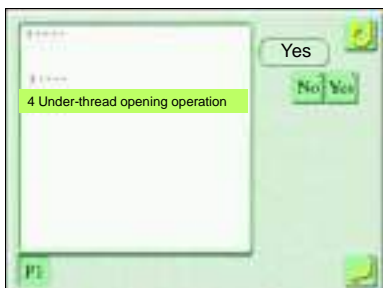

Setting range

Yes: Open the under thread.

When selecting "Yes", "25 Upper thread lock timing" will not be displayed, and "Release" will be fixed to "B".

No: Do not open the under thread.

[76 Stop position]

1 Stop at Lower Dead Point (Input of a password is necessary)

This is the setting to stop (Stop at lower dead point the machine at end of embroidery with the needle stuck.

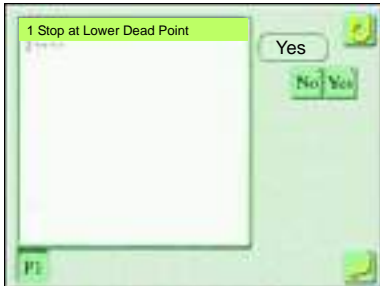

Setting range

Yes: Stop at Lower Dead Point is performed.

No: Stop at Lower Dead Point is not performed.

2 Return Frame at Lower dead point (Input of a password is necessary)

This is the setting to return the frame by manual offset even after frame travel during Stop at Lower Dead Point.

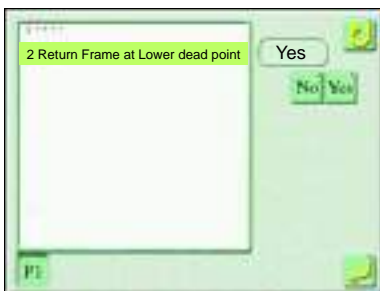

Setting range

Yes: The frame is returned by manual offset.

No : The frame is returned by manual offset. However, the amount of frame travel remains during stop at the lower dead point.

[77 Optional Device (Hardware)]

1 Sequin device (R) (Input of a password is necessary)

Set whether Sequin device (R) will be equipped or not and the type of device.

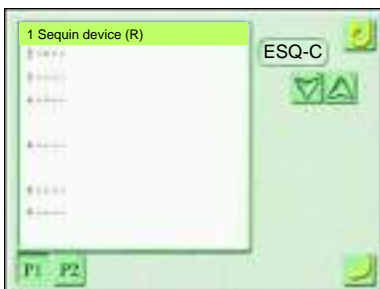

Setting range

ESQ-C: ESQ-C

SQ4: Sequin device IV

No: Without sequin device

Example: ESQ-C

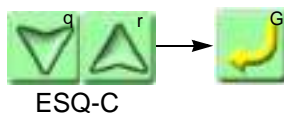

ESQ-C

2 Sequin device (L) (Input of a password is necessary)

Set whether Sequin device (L) will be equipped or not and the type of the device.

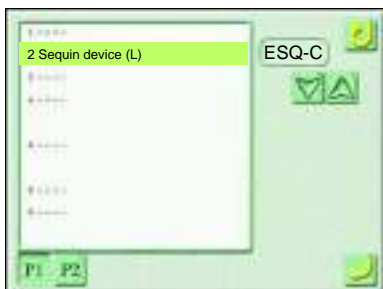

Setting range

ESQ-C: ESQ-C

SQ4: Sequin device IV

No: Without sequin device

3 Insertion of jump at sequin (Input of a password is necessary)

This is the setting to insert one stitch of non-data jump code just before or after sequin feed.

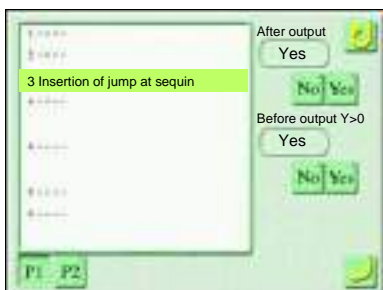

Setting range

After output

Yes: Non-data jump code is inserted just after sequin feed.

No: Non-data jump code is not inserted.

Before output Y>0

Yes: Non-data jump code is inserted just before sequin feed.

No: Non-data jump code is not inserted.

4 Boring device (Input of a password is necessary)

Set to equip/not to equip Boring device.

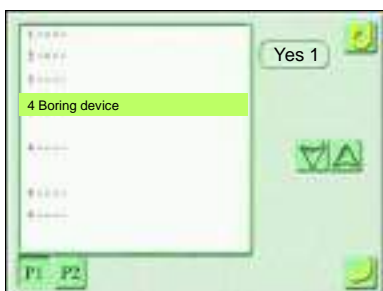

Setting range

Yes 1: Device is equipped to 1st needle.

Yes 2: Device is equipped to 2nd needle.

Yes 15: Device is equipped to 15th needle.

8 Air Pressure Sensor (Input of a password is necessary)

Set to equip/not to equip an air compressor.

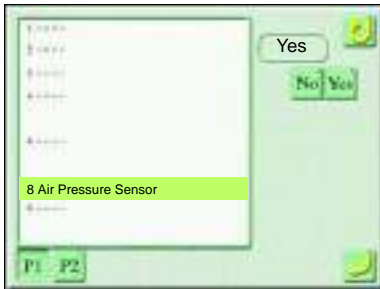

Setting range

Yes: Air compressor is equipped.

No: Air compressor is not equipped.

In this function, when option that needs air compressor is equipped, select "Yes". (Example: Sequin device IV, etc.)

9 Auto lubrication system (Input of a password is necessary)

Set whether Automatic lubrication system will be equipped or not and the type of the device.

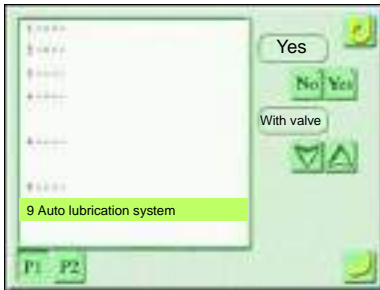

Setting range

Yes: Automatic lubrication system is equipped.

If "Yes" is selected, select the type of the device.

With valve

Without valve

No: Automatic lubrication system is not equipped.

11 Bobbin changer (Input of a password is necessary)

Perform setting as with/without the bobbin changer.

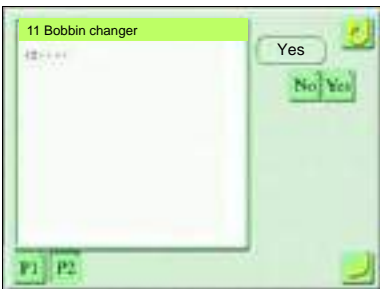

Setting range

Yes: Bobbin changer is equipped.

No: Bobbin changer is not equipped.

12 LED lamp (Input of a password is necessary)

Perform setting as with/without LED lamp.

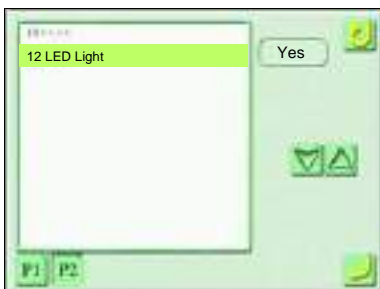

Setting range

Yes: Bobbin changer is equipped.

No: Bobbin changer is not equipped.

18 Seed Beads Device (Input of a password is necessary)

Set whether Seed beads device is mounted or not.

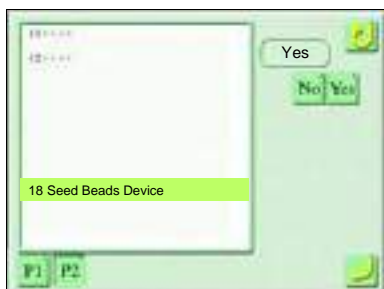

Setting range

Yes: Bobbin changer is equipped.

No: Bobbin changer is not equipped.

[78 Optional device (Software)]

1 Network (Input of a password is necessary)

Set whether network connection with DG/ML by Pulse is performed or not and IP address, etc.

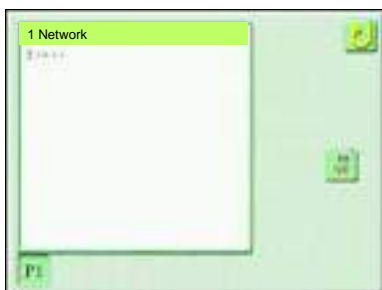

Setting range

[Page P1]



Network

DG/ML [V1]: Connect with DG/ML by Pulse.

No: Network is not connected.

IP Address

Auto: IP address will be obtained from DHCP server.

Manual: Obtain following items manually without using DHCP server.

IP Address

Subnet mask

Gateway

Add gateway

Yes: Add gateway.

No: Do not add gateway.

[Page P2]

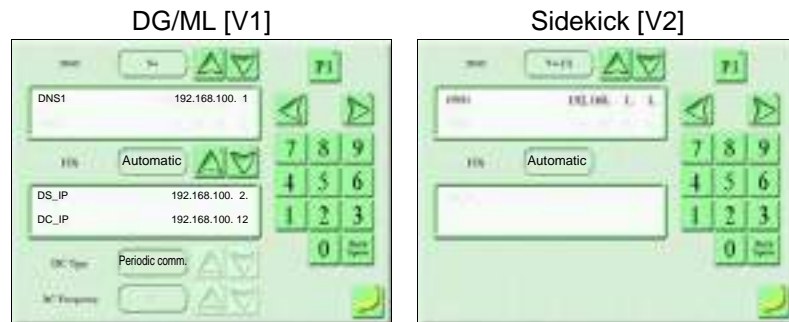
**DNS**

Yes[1]: IP address of DNS1 server

Yes[2]: IP address of DNS2 server

No: Bobbin changer is not equipped.

FIX

Auto: Search IP address of the host PC side automatically.

Manual: Set IP address of the host PC side manually.

Individual: Set the IP address of the host PC side individually.

DS_IP

Input the IP address of the host PC used as Design Spooler to "DS_IP".

It is possible to use by combining with DG15 by Pulse or later version.

DC_IP

Input the IP address of the host PC used as Data Collector to "DS_IP".

It is possible to use by combining with DG15 by Pulse or later version.

DC Type

To select information transmitting method to Data Collector

Not to transmit.

Periodic comm.: Communicating periodically

Event comm.: Transmitting at the start and the stop of operation only

DC Frequency

To select information transmitting frequency (time interval)

1 to 999,999/1 second



2 Network name (Input of a password is necessary)

Set Network name.

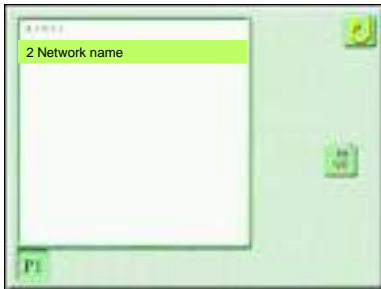

2-7. Page P8

Page P8 shows the operation that has the purpose to perform the maintenance of the machine by the service personnel of your distributor. To change the parameter, it is necessary to input a password.

For details, consult the distributor.

[How to switch to page P8]

(1) Icon G

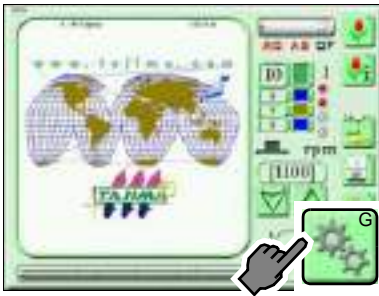

(2) Press P6 twice.

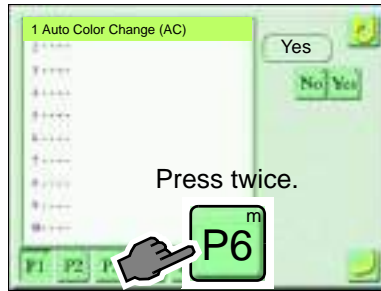

(3) Icon S

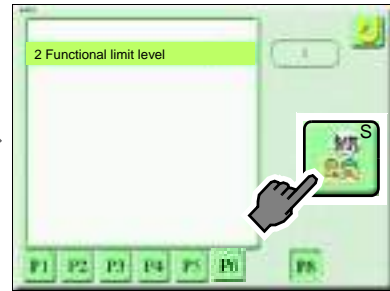

(4) Input a password.

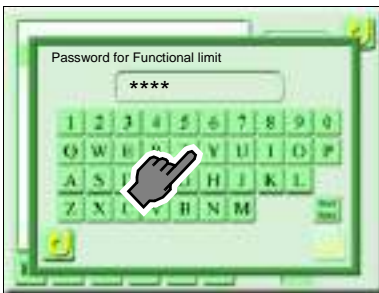

(5) To set



(6) SEL

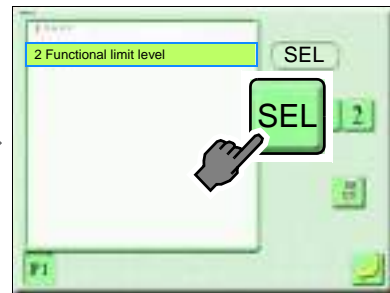

(7) Icon T

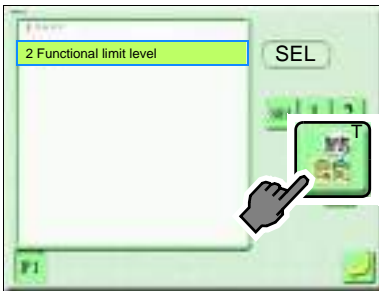

(8) ALL Yes

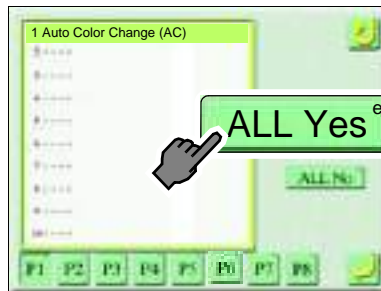

(9) To set

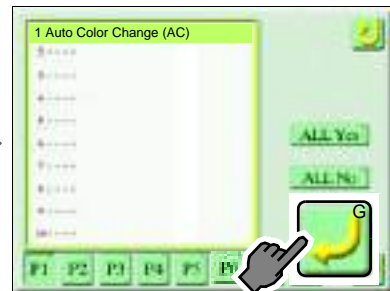

(10) To set

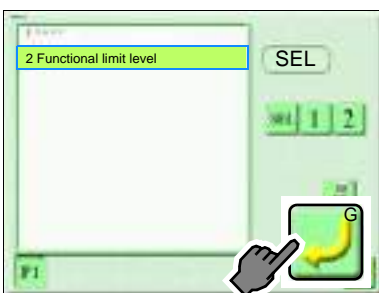

(11) Icon A

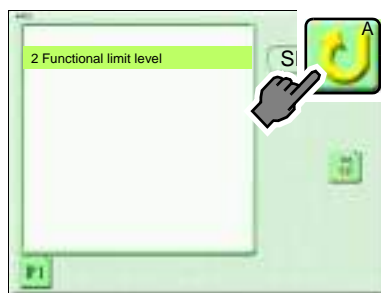

(12) Page P8

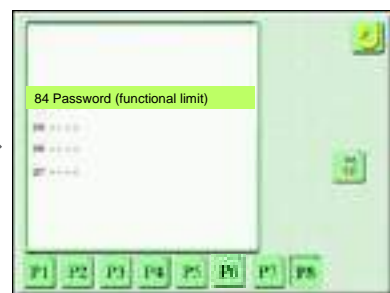

[84 Password (functional limit)]

1 Password (Functional limit level) (Input of a password is necessary)

Change the password. Select the password from 4 to 8 digits alphanumeric characters.

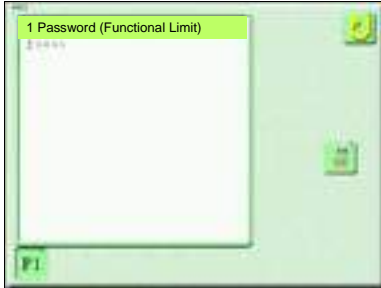

For details of the password, consult the distributor.

2 Functional limit level

Change the operation level (1, 2, SEL). The operation will be limited depending on the operation level.

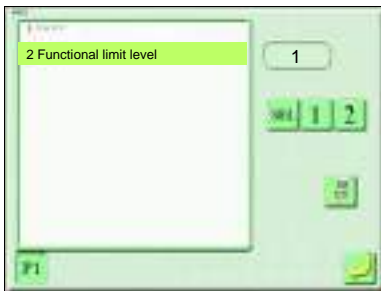

Setting range: 1, 2, SEL

For details of the password, consult the distributor.

[85 Machine adjustment]

1 Date and time (Input of a password is necessary)

Set date and time.

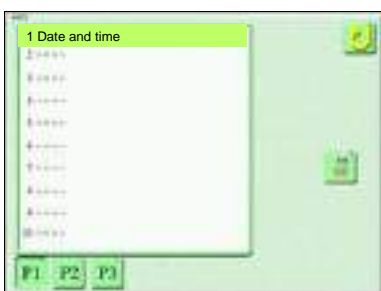

Setting range: Year, month, day, time, second

2 Total number of thread breakage (Input of the password is necessary)

Display the number of thread breakage of upper thread/under thread by head unit.

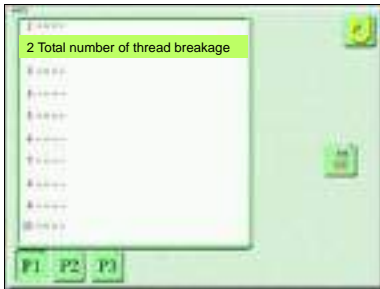

3 Error stack (Input of a password is necessary)

Display errors that have ever occurred and time of occurrence on the operation panel.

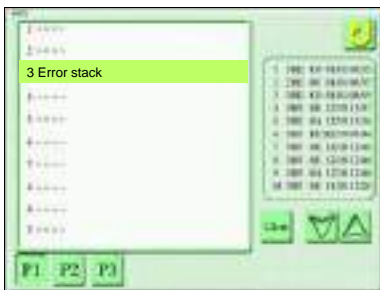

The error to be occurred last is No.1

4 Memory Process (Input of a password is necessary)

Deal the data in the machine memory.

CAUTION

If "Memory initialize" is executed, the design data, general setting data and the set amount of "86 Machine Condition" will be deleted.

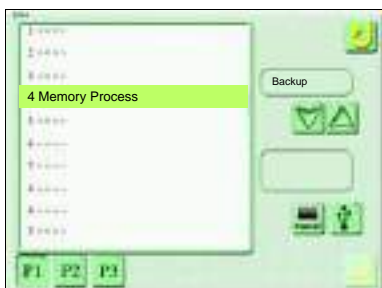

Setting range

Backup

The setting data ^[1] recorded in the machine will be saved into the USB memory or the operation panel. (It is also possible to select both the USB memory and the operation panel.)

When saving the data into the USB memory, set the USB memory to the operation panel before operating, then select icon B.

USB memory



Operation panel



Parameter initialize

Setting data ^[1] will be returned to the value at shipment from the factory. However, the value of "86 Machine condition" will not be changed.

Memory initialize

The design data and general setting data ^[2] will be deleted. When setting again after this operation, refer to "Parameter setting chart" attached to the machine at shipment.

[1] Parameter setting value, Error stack

[2] R.P.M., Total stitch count, Display of finishing embroidery, Frame Back, Frame Forward

Writing

The setting data saved in the USB memory or the operation panel will be written into the machine by the operation of "Backup". To write the setting data written in the USB memory into the machine, set the USB memory to the operation panel before operating, then select icon B.



5 Machine log data Download (Input of password is necessary)

Get the operation logs and the communication records. This function is for analyzing cause of some trouble of the machine. When your distributor asks to get log datas, send datas to your distributor saving log data information in the USB memory by the following operation.



Setting range

Save on operation panel

Save the log datas into a CFast card inside of the operation panel for 50 times. The log datas exceeding 50 times will be overwritten.

Save in USB.

Save the log datas saved in a CFast card and log datas acquired this time into USB memory.

6 Display of main shaft stop position (Input of a password is necessary)

It displays whether the current main shaft angle is within the range of fixed position or not.

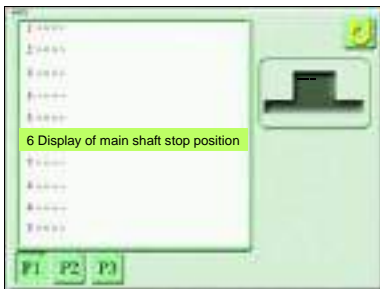

Within fixed position



Out of fixed position, or Stop at Lower Dead

7 Display of needle position angle (Input of a password is necessary)

Display the value of the color change potentiometer and set the ball-screw type color change system.

CAUTION

 If icon q or r is selected, color change will be performed. Do not put your hands etc. near the needle bar case. You could be injured.

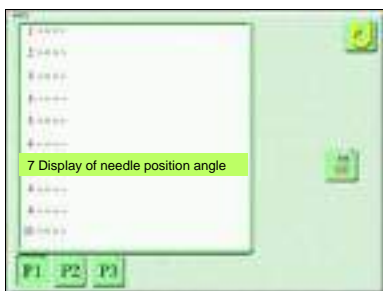

Example: Display the value of color change potentiometer.

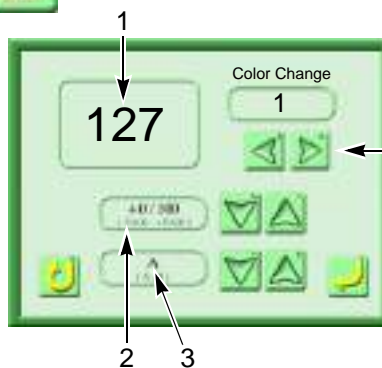

If icon q or r is selected, color change will be performed.

1. Value of potentiometer of needle bar selected currently
It is normal when the value at the first needle is "127".
2. Correcting value of color change position
After Memory initialize, set the value of "Correction of Color interval" mentioned on the label stuck on the operation panel stand.
3. Color change speed
A: Standard
B: Low speed

8 Time for detect power failure (Input of a password is necessary)

Set the machine movement when the power is shut off momentarily.

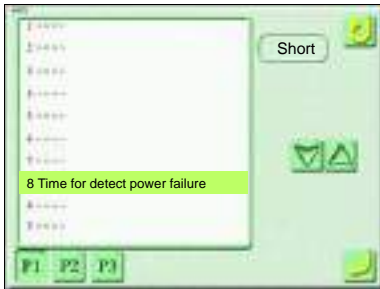

Setting range

Short

When the power is shut off momentarily, the machine will stop at the fixed position.

Long

It is possible to embroider without stopping the machine even if the power is shut off momentarily in longer time than "Short". However, when the power is shut off during some period of time, the machine will stop. In this case, the design in the middle of embroidery cannot be guaranteed.

9 Main Shaft Brake (Input of a password is necessary)

This is the setting to apply/not to apply the brake of Main shaft motor at stop of the machine.

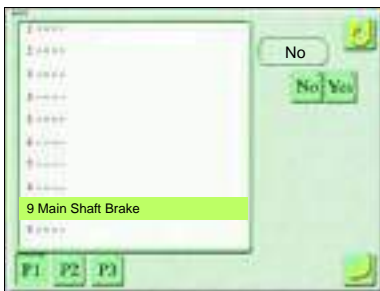

Setting range

Yes: Apply the brake. (Fixing main shaft)

No: Do not apply the brake. (Release of fixing main shaft)

If "No" is selected, it is possible to turn the main shaft by hand with the power ON.

10 Frame servo lock (Input of the password is necessary)

This setting selects to lock/not to lock X/Y-axis motor.

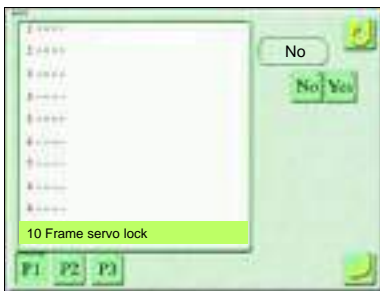

Setting range

Yes: X/Y-axis motor is locked.

No: X/Y-axis motor is unlocked.

X/Y-axis motor will be unlocked by setting to "No". Therefore, it will become impossible to embroider.

12 Manual frame travel speed (Input of a password is necessary)

Perform fine tuning of Frame travel speed when Manual frame travel is performed.

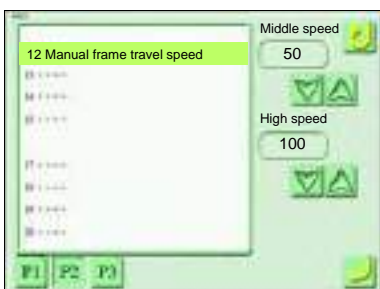

Setting range

Middle speed: 30 to 70 mm/second

High speed: 80 to 150 mm/second

13 Automatic frame travel speed (Input of a password is necessary)

Perform fine adjustment of frame travel speed at offset frame travel.

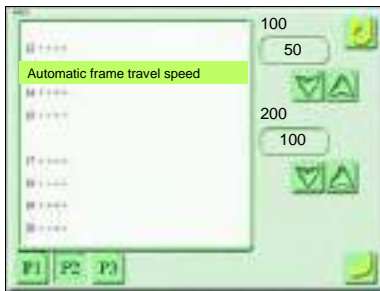

Setting range

100: 80 to 150 mm/second

200: 180 to 220 mm/second

The value here will be reflected in "4 Frame Travel Speed" of page P7.

14 Frame weight data install (Input of the password is necessary)

Perform the additional installation of frame weight data.

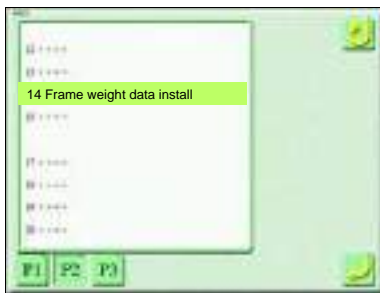

Set the USB memory in which frame weight data is saved and execute it. For the details, consult the distributor.

15 Software install (Input of a password is necessary)

Upgrade the version of the software.

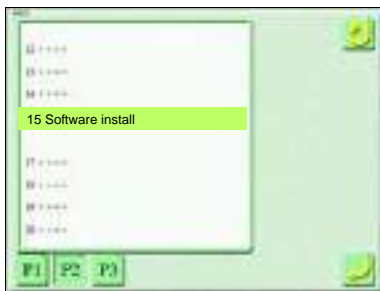

Refer to the detail page.(→p.235)

17 Sequin chip feed (Input of a password is necessary)

This is the setting to feed sequin chips one by one with the tension base switch.

It is possible to operate only when the needle bar equipped with Sequin device is selected.



Example: Feed out sequin ship of 3rd head.

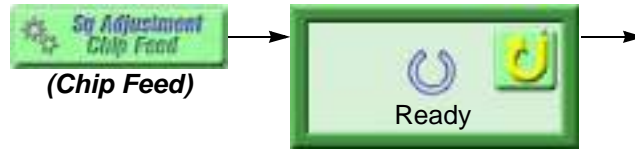

Tension base
H2 switch

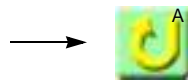

Completed.

Press H2 switch. Sequin chips will be fed out.

Main shaft angle

Fixed position

Out of fixed position



20 Needle bar upper dead point adjustment (Input of a password is necessary)

Refer to the separate volume "MACHINE SETUP INSTRUCTIONS".

21 Air lifter adjustment (Input of a password is necessary)

[86 Machine condition]

CAUTION

The setting items described below are already set at shipment. Therefore, do not change these settings. Wrong setting could cause trouble in movements of the machine.

1 Machine type, machine number (Input of a password is necessary)

Set the machine number and the machine type.

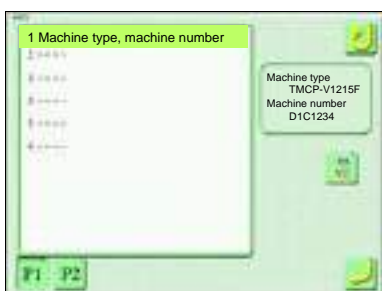

It is set when the machine is shipped. Therefore, it is unnecessary to set again.

2 Head interval (Input of a password is necessary)

Set X-axis embroidery space.

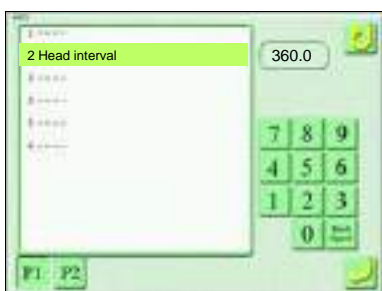

It is set when the machine is shipped. Therefore, it is unnecessary to set again.

3 Y-axis frame size (Input of a password is necessary)

Set Y-axis embroidery space.

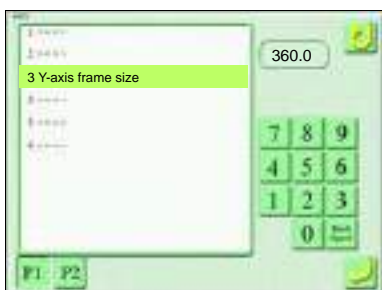

It is set when the machine is shipped. Therefore, it is unnecessary to set again.

4 Frame spec. (Input of a password is necessary)

Set Frame spec.

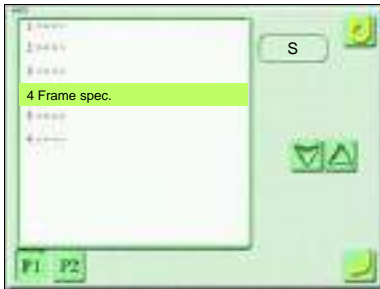

It is set when the machine is shipped. Therefore, it is unnecessary to set again.

5 Overlap (Input of a password is necessary)

Set Overlap width between heads.

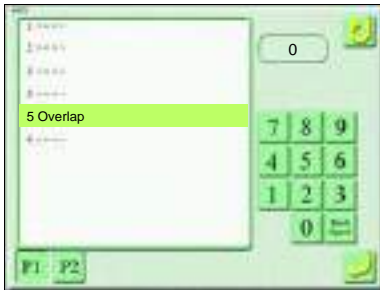

It is set when the machine is shipped. Therefore, it is unnecessary to set again.

6 Maximum RPM (Input of a password is necessary)

Set the maximum speed.

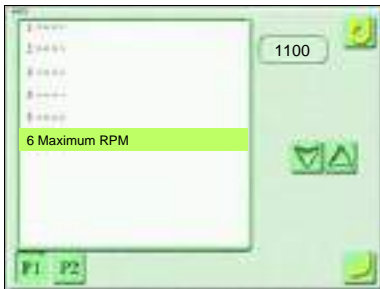

It is set when the machine is shipped. Therefore, it is unnecessary to set again.

11 Frame weight level (Input of a password is necessary)

Set frame weight level. Data adjusted at various length according to the frame weight level will be registered.

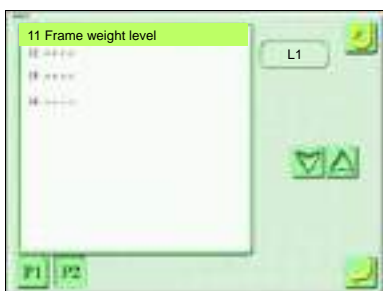

Setting range

L1 ~ L9, T1 ~ T3

To return to the initial value, refer to the label stuck on the position as shown below figure.

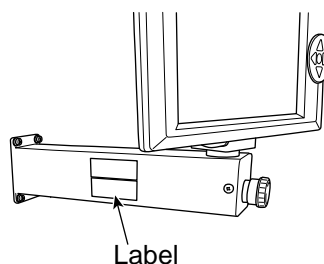

Label

Frame weight level at shipment is described.

To perform fine adjustment, set the frame weight level, and then change the following settings.

12 X Stitch Length Adjustment (Input of the password is necessary)

13 Y Stitch Length Adjustment (Input of the password is necessary)

14 X Stitch Length Adjustment (FS mode) (Input of the password is necessary)

15 Y Stitch Length Adjustment (FS mode) (Input of the password is necessary)

12 X Stitch Length Adjustment (Input of the password is necessary)

Perform fine adjustment of stitch length according to its length.



Setting range

1 to 12: Applicable stitch length (mm)

-60 to +60: Increasing/decreasing amount

-60 ← 0 → +60
Decrease Increase

13 Y Stitch Length Adjustment (Input of the password is necessary)

Perform fine adjustment of stitch length according to its length.

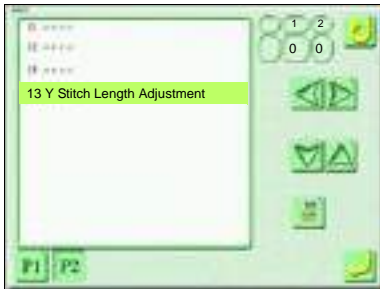

Setting range

1 to 12: Applicable stitch length (mm)

-60 to +60: Increasing/decreasing amount

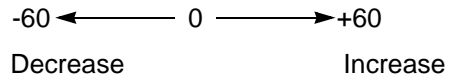

14 X Stitch Length Adjustment (FS mode) (Input of the password is necessary)

In FS mode, perform fine adjustment of stitch length according to its length.

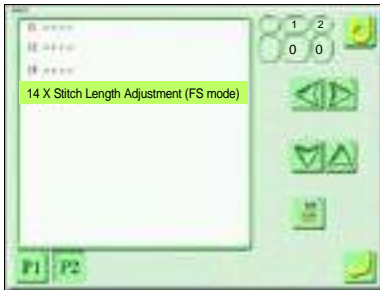

Setting range

1 to 12: Applicable stitch length (mm)

-60 to +60: Increasing/decreasing amount

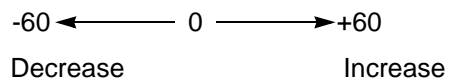

15 Y Stitch Length Adjustment (FS mode) (Input of the password is necessary)

In FS mode, perform fine adjustment of stitch length according to its length.



Setting range

1 to 12: Applicable stitch length (mm)

-60 to +60: Increasing/decreasing amount

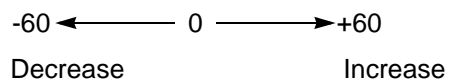

[87 Panel setting]

1 Sound volume (Input of a password is necessary)

Adjust a sound volume of a buzzer.

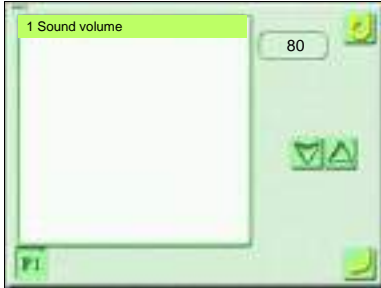

Setting range

80 to 100 (%)

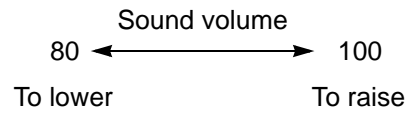



Chapter 10

Outline of functions

1. Condition data	192
2. Offset Frame Travel.....	193
3. Trace	196
4. FS mode	197
5. Head group.....	202
6. Marking.....	208

1. Condition data

When a design saved in the USB memory is registered into the machine memory, it is possible to register the condition data (three items below) together with the design into the machine memory. However, the design is limited to "T2" or "T3" saving format.

This function is effective only when the parameter setting "2 Condition data" is "Yes".(→p.167)

1. Color change sequence

The whole color change sequence included in the design can be registered into the machine memory. Therefore, it is unnecessary to set it again.

2. Start position

The frame position where the machine started embroidering last time can be registered in the machine memory. Therefore, it is unnecessary to adjust the position of the frame.

Moreover, by setting the following 3 items after data set, each setting contents will be added in a design. Therefore, it is unnecessary to set again when you embroider this design next time.

1. Data conversion(→p.104)
2. Design repetition(→p.108)
3. Automatic Offset(→p.98)

The following setting items can be saved / or cannot be saved depending on saving destination.

○ : Enable to save

× : Unable to save

Setting item	Saving into machine memory	Saving into USB memory		Saving from DG/ML by Pulse to memory of the machine
		T3, T2	T	
Color change sequence ^[1]	○	○	×	○
Start position	○	○ ^[2]	×	×
Data conversion	○	×	×	×
Design repetition	○	×	×	×
Automatic Offset	○	×	×	×

[1] Automatic Free Setting Offset included in the color change sequence is also included.

[2] When you embroider the design between models with different embroidery spaces, the start position may differ depending on the model.

2. Offset Frame Travel

2-1. Automatic Offset

The frame will move to the registered position (Offset position) automatically after completion of embroidery. The frame will move to the start position automatically after starting the machine operation.

[Examples of use]

- (1) The frame will move to the offset position automatically after completion of embroidery.

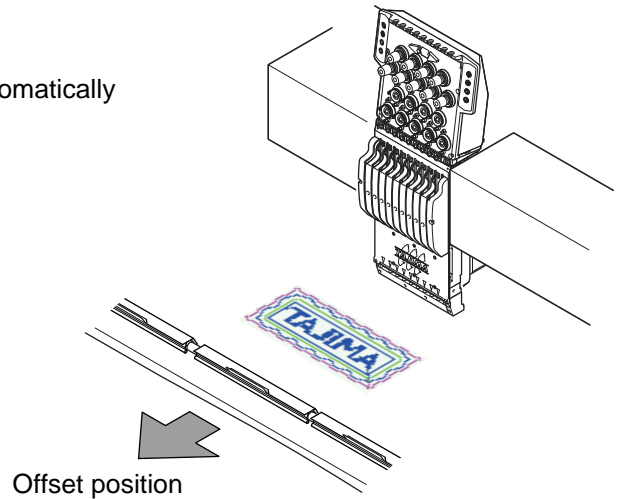

- (2) Change the fabric.

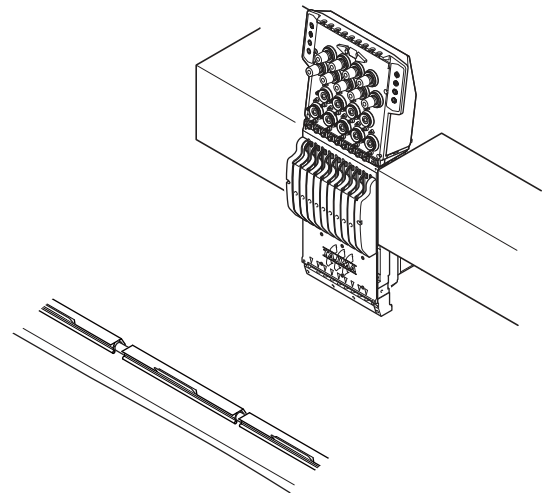

- (3) Start the machine operation.

After starting of the machine, the frame will move to the start position automatically, then the machine will start embroidering. After completion of embroidery, the frame will move to the offset position automatically.

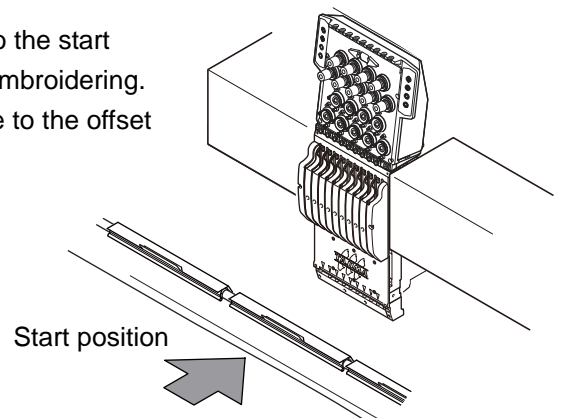

2-2. Automatic free-setting offset

In addition to the function of "Automatic offset" described previously, the frame will move to the position registered (Offset position) automatically at the free-setting point in the middle of embroidery. The frame will move to the free-setting point after starting the machine.

[An example when using appliques]

(1) Start the machine operation.

After starting the machine operation, the frame will move to the start position automatically.

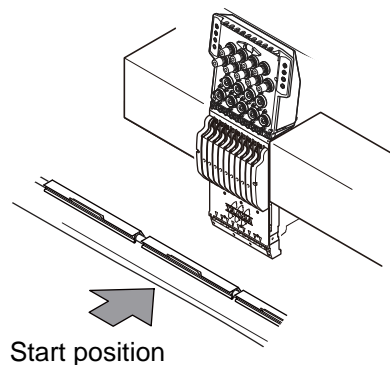

(2) The frame will move to the offset position automatically at the free-setting point in the middle of embroidery. Place the fabric of applique here.

Fabric for put-on embroidery

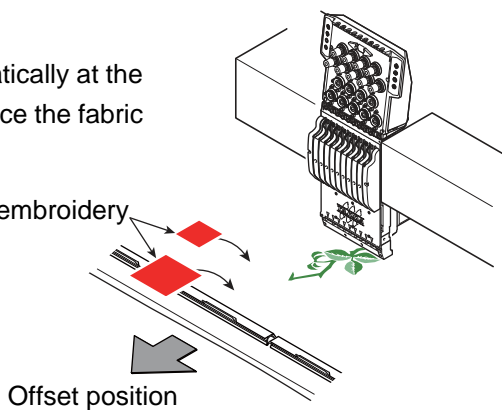

(3) Start the machine operation.

After starting the machine operation, the frame will move to the free-setting point, then the machine will restart embroidering.

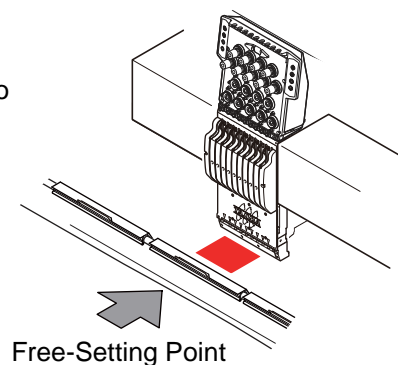

(4) The frame will move to the offset position automatically after completion of embroidery.

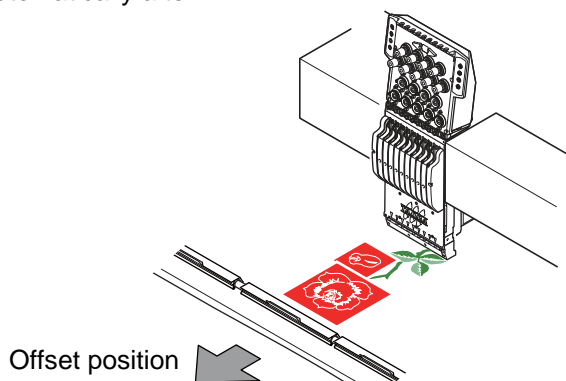

2-3. Auto Color Change Offset

In addition to the function of "Automatic offset" described previously, the frame will move to the position registered (Offset position) automatically at the color change point in the middle of embroidery. The frame will move to the color change point after starting the machine.

[An example when using appliques]

(1) Start the machine operation.

After starting the machine operation, the frame will move to the start position automatically.

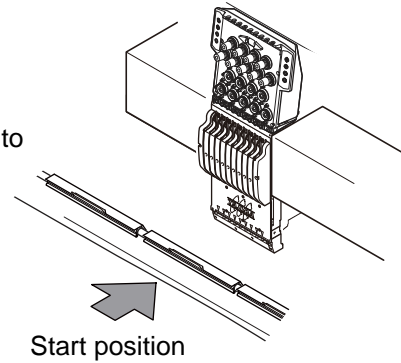

(2) The frame will move to the offset position automatically at the color change point in the middle of embroidery. Place the fabric of applique to be fixed here.

Fabric for put-on embroidery

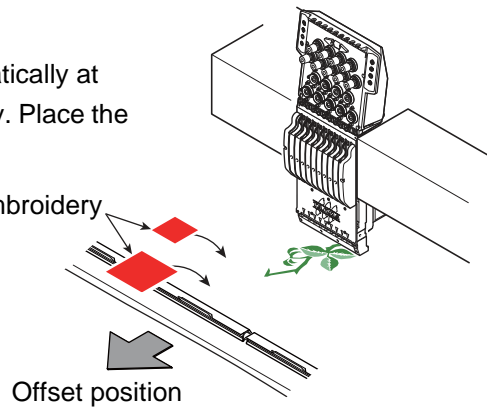

(3) Start the machine operation.

After starting of the machine, the frame will move to the color change point automatically, then the machine will restart embroidering.

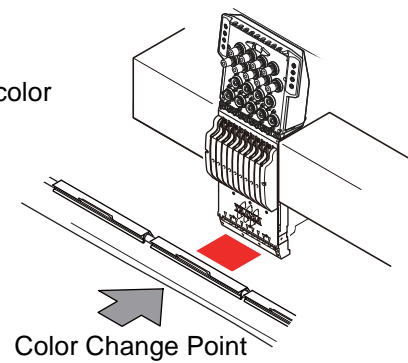

(4) The frame will move to the offset position automatically after completion of embroidery.

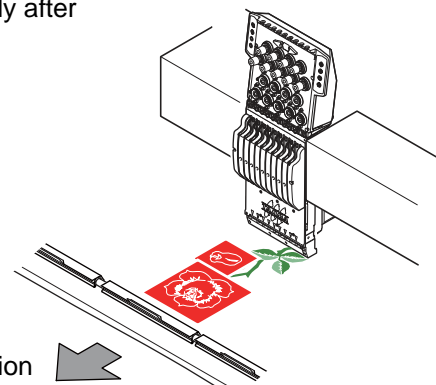

3. Trace

The frame will move along a periphery of the design from the start position.

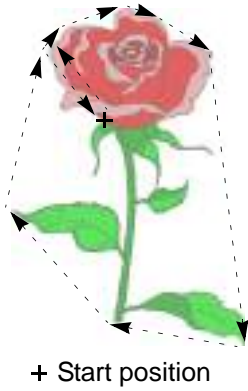

When automatic offset is set, the frame will move to → 1 Offset position → 2 Middle position → 3 Start position → 4 Periphery → 3 Start position → 2 Middle position → 1 Offset position (in the order).

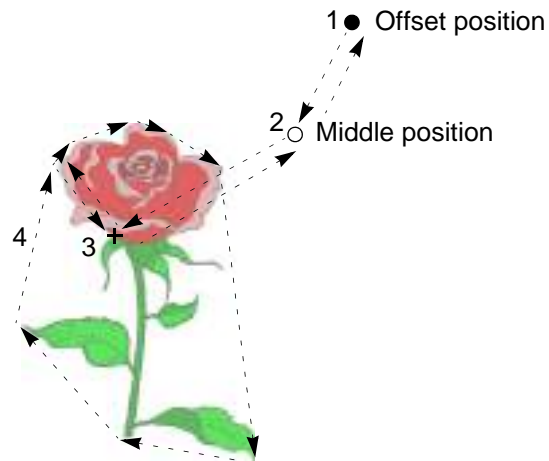

When repeat is set, the machine will trace the whole design after tracing the first design.

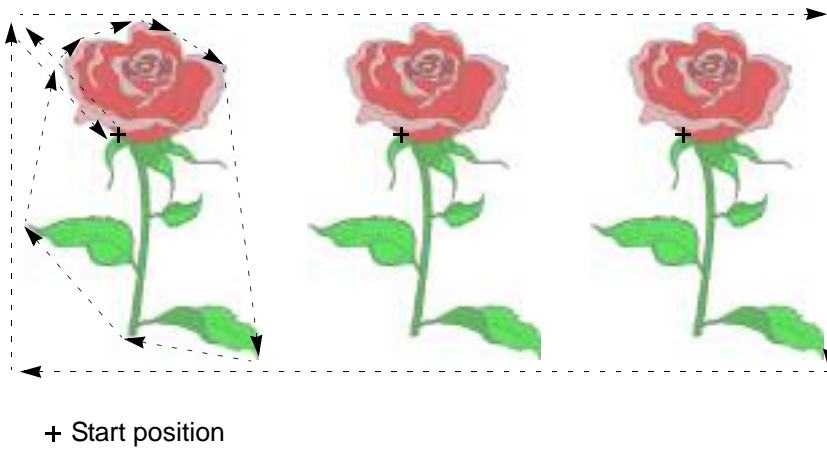

4. FS mode

Operation of this function will improve finish of sewing even in case of using badly passing thread (the tinsel, the thick thread) or loosely twisted thread. (Conventional ratio)

This function is specially effective for the embroidery using loosely twisted thread that was improper for the embroidery machine.

(1) Improved points in FS mode

The following points are not applicable to all embroidery conditions. Depending on the embroidery condition, improvement may not be seen.

- Decrease of thread breakage (Tinsel)
- Improvement of thread tension for Satin stitch (Loosely twisted thread, Thick thread)
- Stabilization of Satin stitch (Loosely twisted thread)
- The balance between the upper thread and the under thread is stable on the back of the fabric. (All thread type)
- Decrease of bad thread tension points of the emblem embroidery (Polyester yarn)

(2) Movement of the machine in FS mode

FS mode is the function giving priority to the embroidery quality. Therefore, the productivity may lower under the following conditions.

Use it after understanding the followings.

- Maximum R.P.M. is limited.
- A specified stitch length will perform Auto jump.

4-1. Sewing comparison

(1) Sewing comparison by the difference between standard mode and FS mode

Thread type: Rayon 300 d/1



Standard mode



FS mode

(2) Sewing comparison by the difference of threads

Sewing samples (A, B, C) as below are embroidered by FS mode. It is possible to embroider like samples A, B even if loosely twisted thread is used. If the sample A and B (specially A) are embroidered by standard mode, problems such as fluffing and looping could occur.



Loosely twisted thread
(Rayon 300 d/1)



Thread twisted a little looser (Middle level of twist between A and C) (Polyester 120 d/2)



Normal embroidery thread
(Rayon 120 d/2)

4-2. To improve embroidery results further

We prepare the following optional parts to improve embroidery results further. Select the optional parts according to the embroidery condition such as the thread and the fabric.

The parts below (1) to (3) are not the set parts.

Before using the product, please understand [Note], and consult the distributor.

As a sample item, thread guides and needles for 2 needles are packed in the machine.

4-3. Optional parts

(1) Thread guide

Part name	Part No.
THREAD GUIDE :2.2 MM DIA.	516501040000

In case of using badly passing thread, the upper thread tension will be too tight. Therefore, detach the spiral tube, and attach this thread guide.

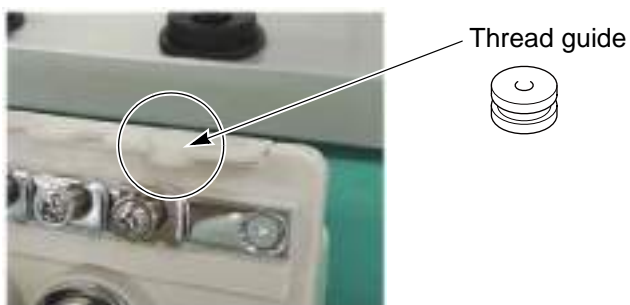

[Note]

When the color change having large slide volume is performed, the thread tangle sometimes occurs.

(2) Needle

Part name	Part No.
NEEDLE :DB-K5Z1 FS #11 U	616500570000
NEEDLE :DB-K5Z1 FS #11 Y	616500580000
NEEDLE :DB-K5Z1 FS #14 U	616500590000
NEEDLE :DB-K5Z1 FS #14 Y	616500600000

These needle are developed for FS mode. It is effective for loosely twisted thread that could not be embroidered so far.

[Note]

It is not suitable for the fabric that requires the strong force to be embroidered through.

(3) Needle plate

Part name	Part No.
NEEDLE PLATE :2.5 MM DIA./34 MM DIA. x DENT 0.5MM	050340540000

In case the thread tension is bad when using badly passing thread, attach this needle plate. Then, the thread tension will be improved.

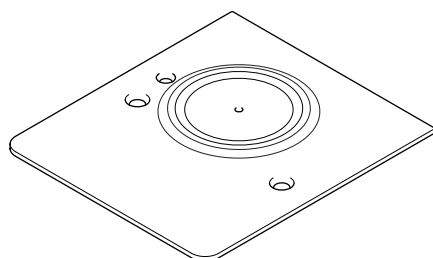
**[Note]**

Skip stitches or thread breakage may occur on a highly elastic fabric. It is also necessary to adjust the lower dead point of presser foot according to need.

4-4. Example of Usage

Select parts according to embroidery condition. For reference information, examples of using optional parts are shown in the table below. In fact, it may not be applicable depending on the thread, design, fabric etc used.

Embroidery conditions	Optional parts
In case of using tinsel	Thread guide
In case of using the thick thread	Needle plate
In case of using loosely twisted thread	Needle plate, thread guide, needle

5. Head group

This function groups heads (2 to 4 heads) and perform embroidery.

This function enables embroidering big sized design or color scheme exceeding the original number of stitches.

5-1. Outline

[How to switch the screen]

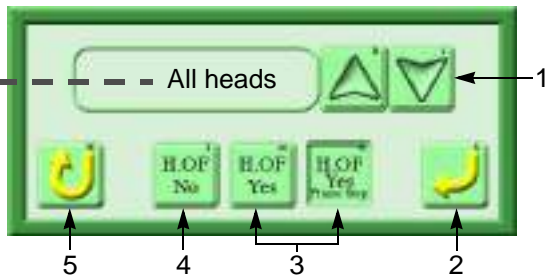

Head group

1. Head group will switch.

All heads (Usual embroidery)

2. Decide.

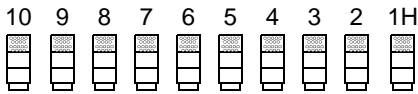

3. Head Offset (movement between heads) is performed/not performed.

2H



When sewing head changes, the machine will perform automatic frame travel and frame stepping by jump to the next head position at the same time (recommended).

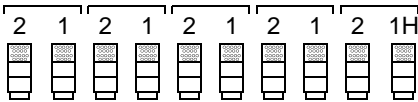

3H



When sewing head changes, the frame will move automatically to the next head position.

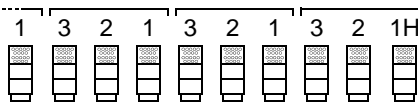

4. Head Offset is not performed.

4H

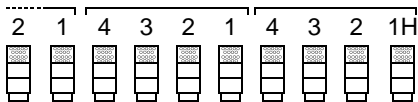

5. Return.

TE2H (All heads + 2H)

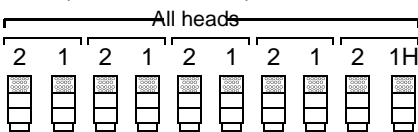

Selected head

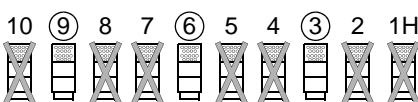

(1) An example when using "2H"

When performing embroidery of 18 colors by using 9-needle machine

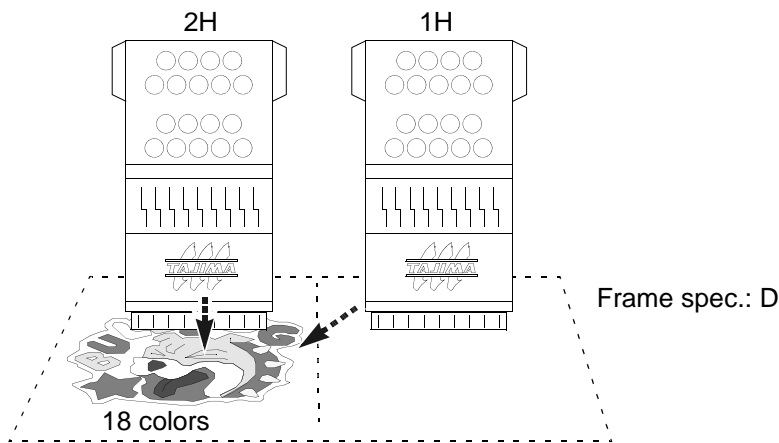

When embroidering one design in an embroidery space of two heads

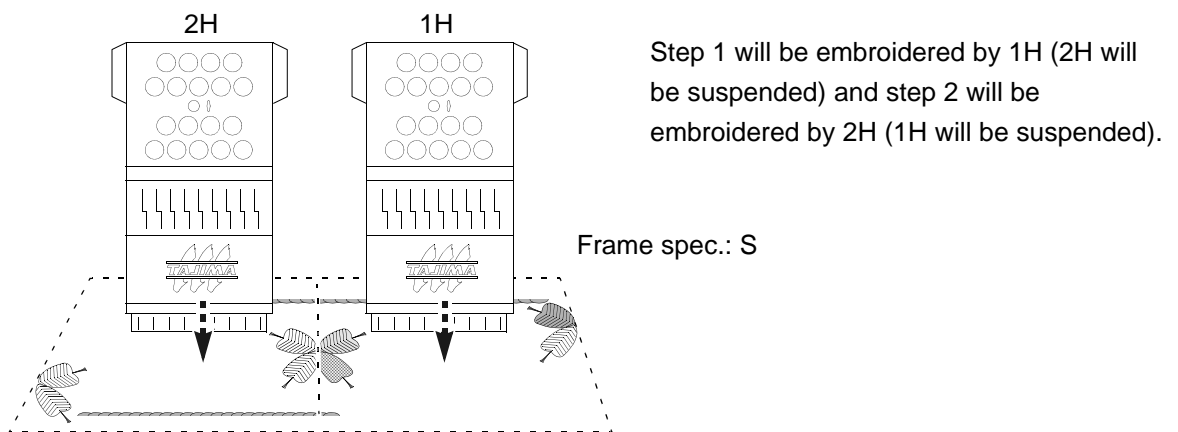

(2) An example when using "Selected heads"

It is possible to move head and needle bar No. you desire by every step.

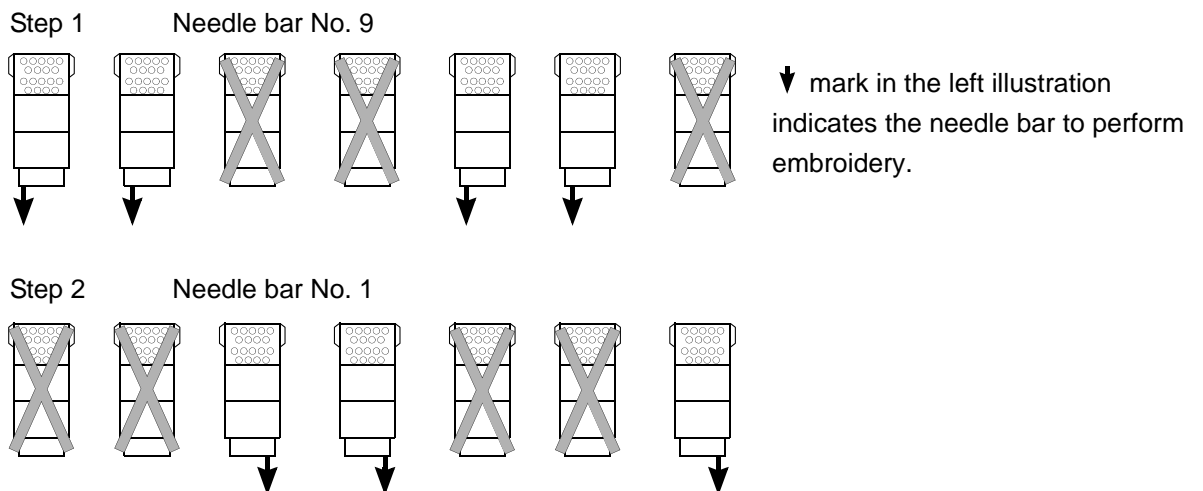

5-2. An example when using head group

When this function is not adapted to "Frame Spec." of the machine, it is not possible to select head offset (H.OF No is the fixed value).

(1) All heads

Perform all heads sewing (usual embroidery).

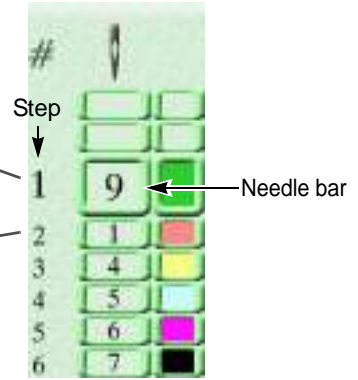
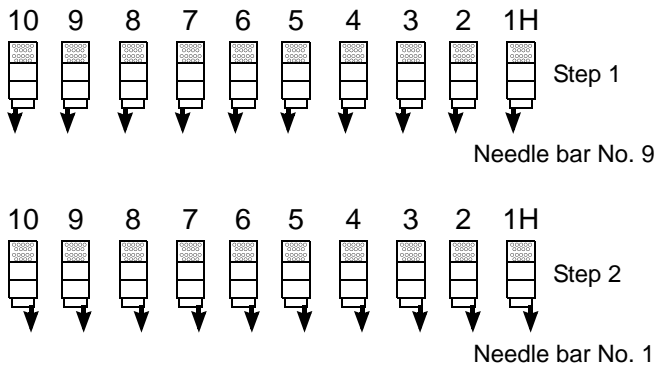

(2) 4H

Four heads are regarded as one group (one head) and only one head in the group will perform sewing.

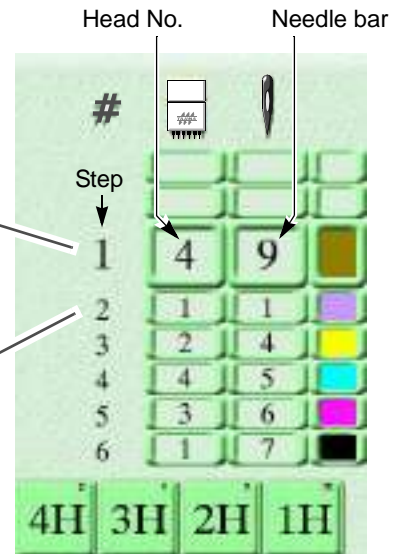
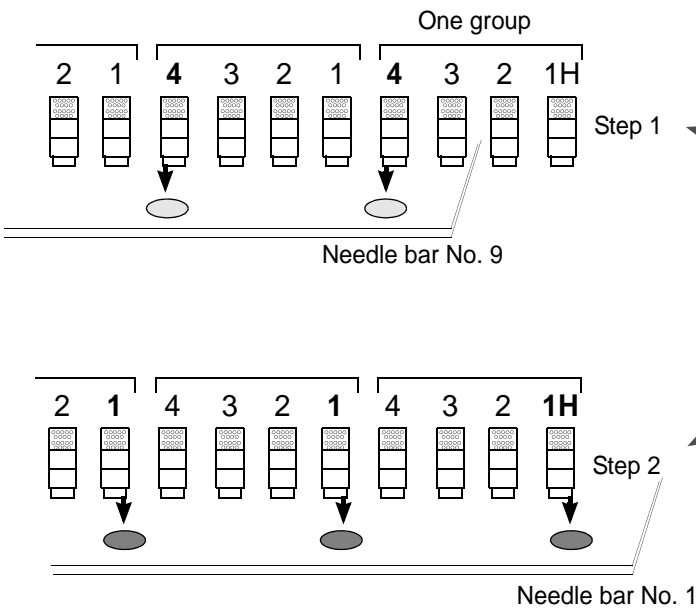

The frame will move to the right (space of the first head) after the machine embroiders step 1 by needle bar No.9 of the fourth head, then the machine will embroider step 2 by needle bar No.1 of the first head.

When the selected heads are different at before-and-after steps, the frame will move right and left (When head offset is set to "YES").

(3) TE2H

It is possible to set "TE2H" only when frame spec. of the machine is T, Q, TE or T2E. In addition, "H.OF YES" is the fixed value of Head Offset (it is not possible to change).

In case of T or Q, the last some heads may not be able to perform embroidery (it differs depending on the number of heads).

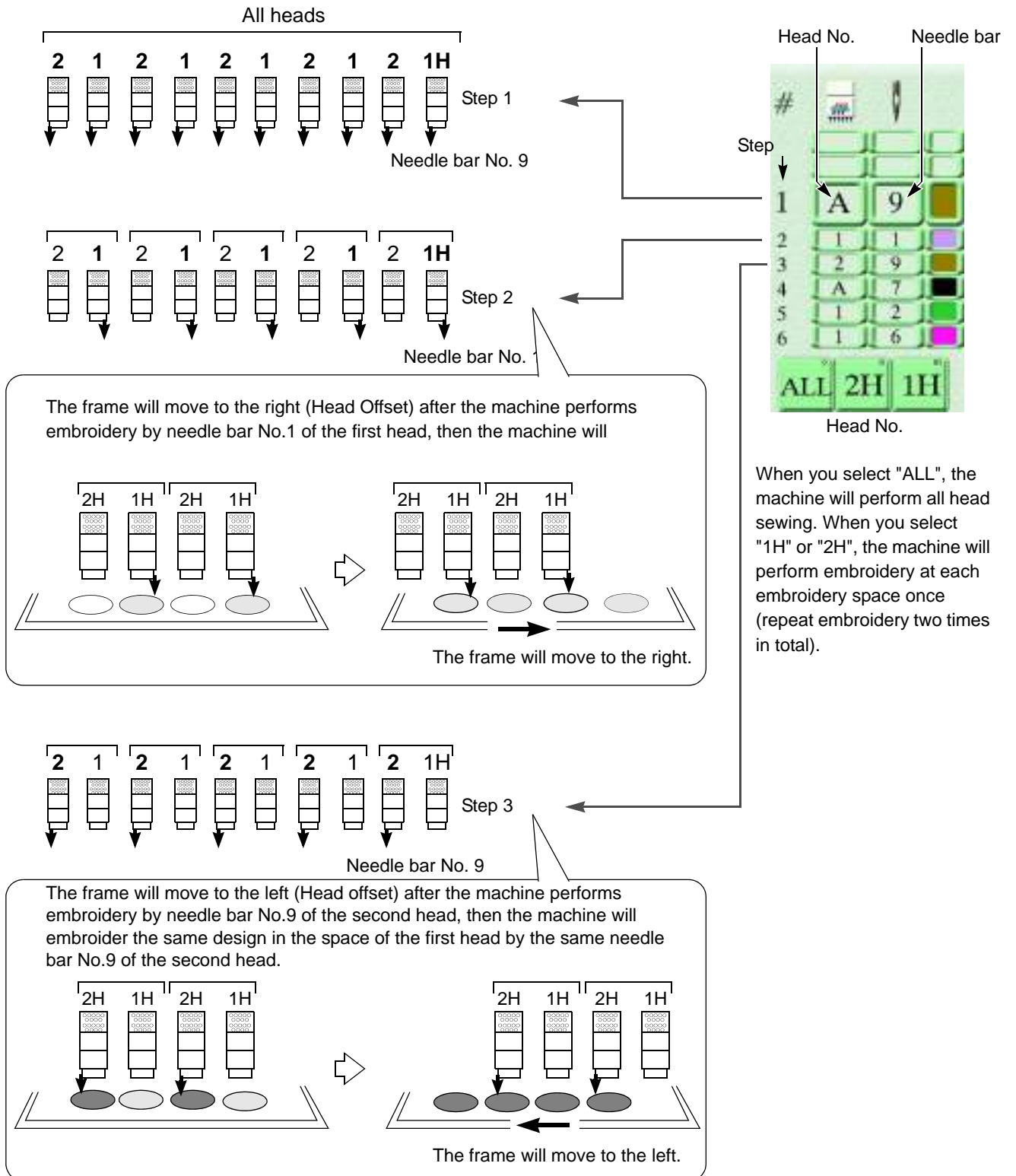

(4) Selected head

Use this function when you want to select the working heads for each Needle Bar Step.

[Head selecting screen (Screen 2010)]

Set the pattern No. for the Needle Bar Step on this screen. The pattern No. will be displayed as P1 to P20, and it is possible to select the working heads for each pattern.

[How to switch the screen]

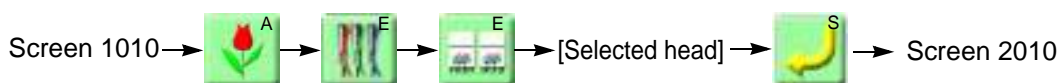

Needle bar step	Pattern No. (Working head)	Needle bar No.
1	P2	3
2	P5	9
3	P3	11
4	P8	7
5	P1	1
6	P10	4

Embroidery will be performed under the conditions as shown below chart in the above example.

Needle bar step	Pattern No.	Needle bar No.
1	P2	3
2	P5	9
3	P3	11
4	P8	7
5	P1	1
6	P10	4

[Pattern setting screen (Screen 2015)]

Set the working head and the suspended head for each pattern from P1 to P20.

[How to switch the screen]

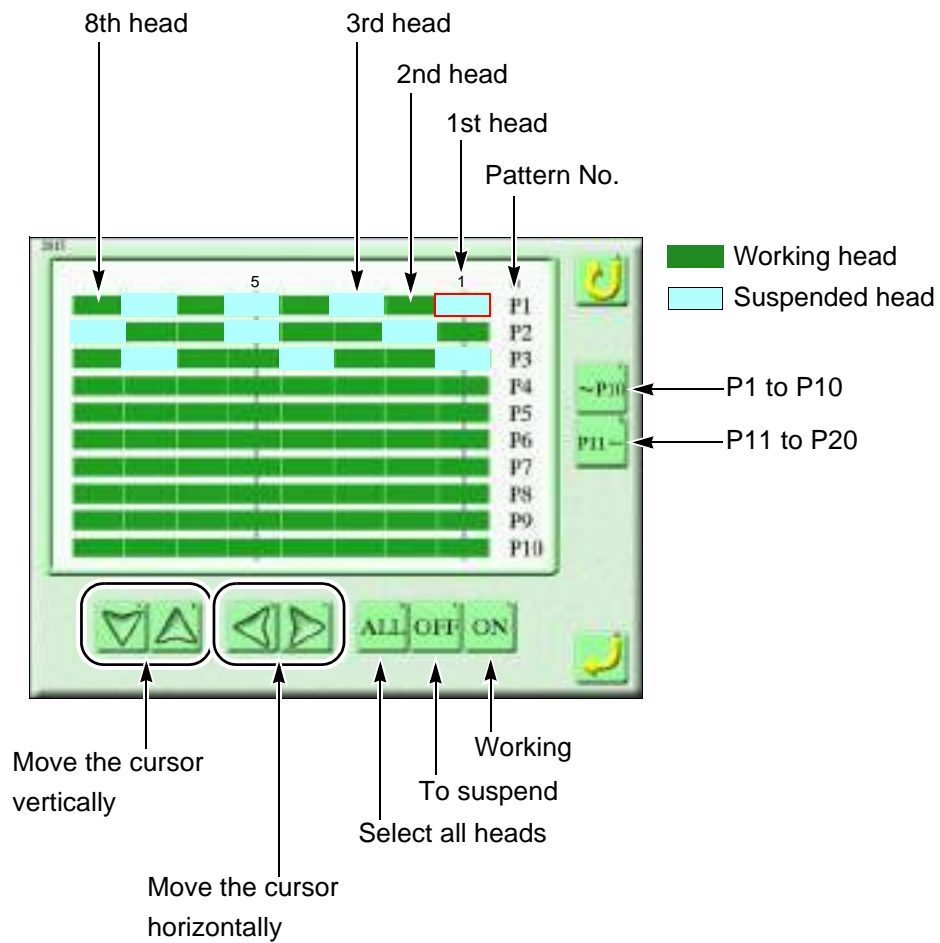

Heads in the chart below will work for each pattern No. in the example above.

Pattern No.	Working head
P1	2, 4, 6, 8
P2	1, 3, 4, 6, 7
P3	2, 3, 5, 6, 8
P4 and after	All heads

6. Marking

6-1. Outline







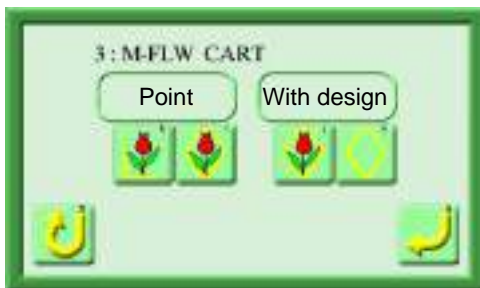



Marking includes "Point" and "Contour". (The figure below is an example.)



(1) Marking setting screen

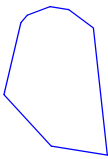

There are following setting patterns of Marking (1 to 4 in the figure below). Use the pattern according to the necessity of your use.

1	<p>Point</p> 	<p>With design</p> 	<p>Register the point with the design into the the memory.</p> 
2	<p>Point</p> 	<p>Without design</p> 	<p>Register the point into the memory independently.</p> 
3	<p>Contour</p> 	<p>With design</p> 	<p>Register the contour with the design into the memory.</p> 
4	<p>Contour</p> 	<p>Without design</p> 	<p>Register the contour into the memory independently.</p> 

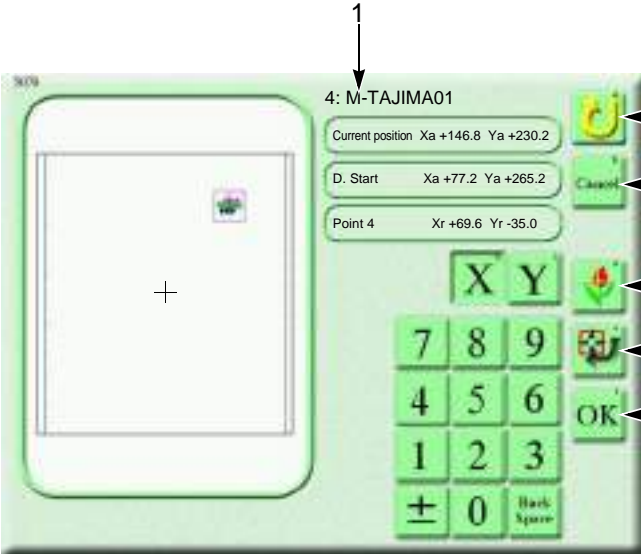

- 1. Marking design name
4: M-TAJIMA01
↑
Memory No.
- 2. To return
- 3. To return by one point
- 4. Displaying the start position of the design (When it is registered)
- 5. Pressing this icon after input of numerical keys will move the frame to the input position.
- 6. To make a point

6-2. An example of using Marking

In case of marking with the design, automatic free-setting offset will be automatically set after marking.

In case of marking data only, automatic free-setting offset will not be set.

When the marking points are set with 2 to 10 spots, those points will be automatically converted to stitch data.

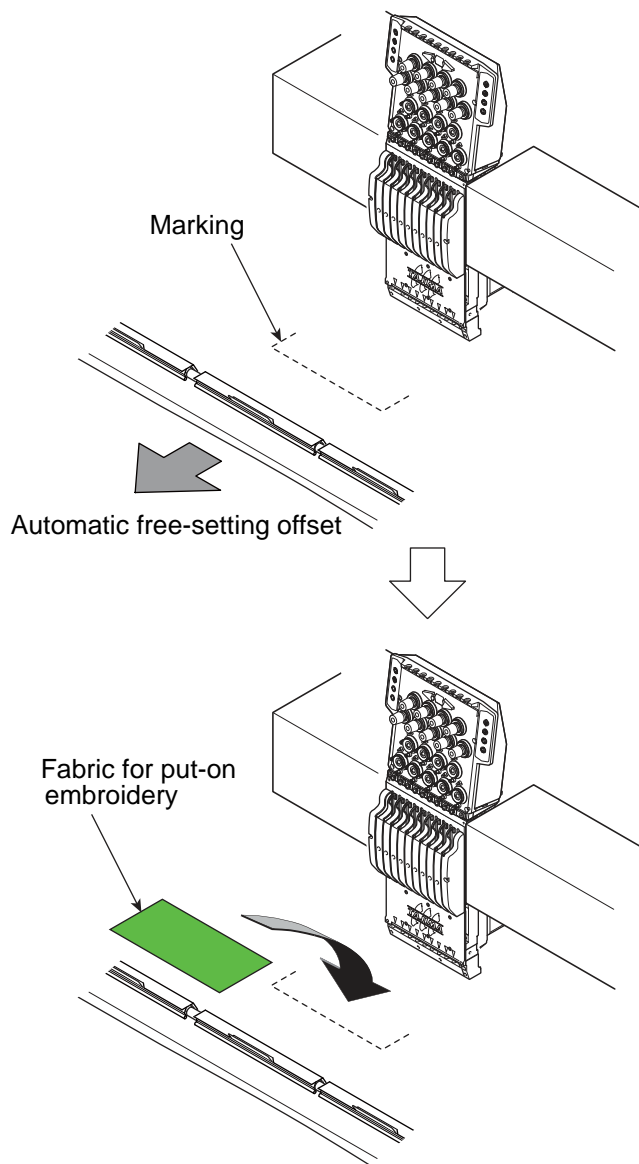

Chapter 11

Troubleshooting, maintenance

1. Troubleshooting.....	212
2. Maintenance.....	221
4. Adjustment of Snap-fit middle thread guide.....	232
5. Upgrading of software (Input of a password is necessary).....	235

1. Troubleshooting

When the machine stops during operation, an error code will be displayed on the screen.

When the machine stops during operation and a code No. is displayed on the screen, cope with the trouble according to the code chart described below.

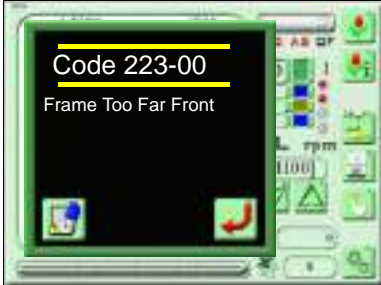

1-1. Stop factor (Code No.)

Cord	Stop factor	Corrective Action
1B1	Stop by frame stepping code. This stop is not caused by an error.	Perform "Start operation" or "Frame Back/ Forward operation", or press any operation key to continue the operation of machine.
1B2	Stop by color change code This stop is not caused by an error.	
1B3	Stop by end code This stop is not caused by an error.	
1B4	Stop by thread trimming code This stop is not caused by an error.	
1B5	Stop by sequin code This stop is not caused by an error.	
1B6	Stop by automatic arbitrary offset code This stop is not caused by an error.	Perform "Start operation" or "Frame Back/ Forward operation", or press any operation key to continue the operation of machine.
1N8	Stop by temporary stop code This stop is not caused by an error.	
1C1	Stop by the stop button Machine stopped by operator s operation.	Continue the operation of the machine if needed. By turning OFF the main power during 1C1 indication, the embroidery may not be continued.
1C3	Halt by input of external stop signal Machine stopped by the stop signal from an external device.	Continue the operation of the machine if needed.
1C4	Stop by switch operation of tension base The machine stopped by the change of tension base switch from clutch to normal during embroi- dery by ESQ-C.	Perform "Start operation" to continue the operation of machine if needed.

Cord	Stop factor	Corrective Action
1D1	Halt at Frame Back start point Machine stopped by the halt setting at the start point of embroidery for all heads after Frame Back operation.	Perform "Start operation" to continue the embroidery.
1D2	Preset Halt Machine stopped by the preset halt setting.	Reset by pressing the reset key. Perform "Start operation" to continue the embroidery.
1D3	Stop for material processing Machine stopped by automatic stop setting for material processing.	Perform the material processing by material cutting and others if necessary. Continue machine operation if necessary.
211-01	Fixed position signal error Machine stopped at other than the fixed position.	Return the main shaft to the fixed position. Adjust encoder/encoder Z signal.
212	In the state of needle bar lowered Needle bar is descending.	Move needle bar up and operate the machine.
213	Lower dead point error Machine is stopping at the lower dead point.	Move needle bar up and operate the machine.
221	Frame Too Far Left Embroidery frame moved to the limit position (left). (+X direction)	Move the frame manually to embroider within the setting of embroidery space.
222	Frame Too Far Right Embroidery frame moved to the limit position (right). (-X direction)	Move the frame manually to embroider within the setting of embroidery space.
223	Frame Too Far Front Embroidery frame moved to the limit position (front). (+Y direction)	Move the frame manually to embroider within the setting of embroidery space.
224	Frame Too Far Back Embroidery frame moved to the limit position (rear). (-Y direction)	Move the frame manually to embroider within the setting of embroidery space.
225	Design size too large Design does not fit within the embroidery space due to the present start position of design.	Move the frame manually to embroider within the setting of embroidery space.
251	Lubrication level error Lubrication level is irregular.	Supply oil to the lubrication tank.
258	Upper dead point sensor error Upper dead point sensor error detected.	Check/replace the upper dead point sensor for ESQ-C.
259	Lower dead point sensor error Lower dead point sensor error detected.	Check/replace the lower dead point sensor for ESQ-C.
25A	Sequin color change sensor failure Color change sensor error detected.	Check/replace the color change sensor for ESQ-C.

Cord	Stop factor	Corrective Action
281	Color changing error The target needle position is not detected even if 8 seconds have passed since the start of color change.	Return needle position to the position of the correct display. Adjust/replace the potentiometer.
291	Stop by detecting thread breakage Machine detected upper thread breakage.	Check the upper and under threads. Check/replace the tension base card.
293	Under thread break Machine detected under thread breakage.	Check the under thread. Check/replace the tension base card.
294	Running out of material detected Machine detected running out of sequin material.	Check/replace Sequin material.
2A1	Thread trimming position adjustment error Adjustment time of thread trimming position was exceeded.	Return ATH movable knife to the correct position. Check and replace the thread trimming motor/thread trimming encoder.
2B2	TAJIMA Complement error Complement error detected in TAJIMA data.	The same values (+ and -) of the design data are valid at the same time. Correct the design data.
2B3	Data found in end code Data is found in end code.	Delete "X/Y moving amount of the end code" of the design data.
2B4	Function code error Function code error occurred.	There is a function code that is not defined. Correct the design data.
2B7	Data set incomplete Data set is not completed.	Operate the machine after setting the data of embroidery design.
2B8	Data pre-reading buffer error Output data cannot be prepared.	During operation: decrease the number of revolutions. During Frame Forward, Do not perform the frame forward any more.
2B9	Memory write error Cannot write data onto memory.	Check and replace CPU card/operation panel.
2BA	Memory capacity exceeded Free space of memory is insufficient.	Increase the free space of memory by deleting unnecessary designs in the designs registered in the memory (after taking the backup if needed).
2BB	Frame Back limit over Frame Back exceeded available range.	Do not perform Frame Back any more.
2BC	Design No. error Design No. cannot be found. Not editable due to data setting. Design is not registered in memory.	Edit the design you wish to edit after the data set of the design. Register the design to the memory.
2BE	Incorrect function code segment Start/end codes are not registered in a pair for the function which has start/end.	Modify/set the design again so that the codes of start/end become a pair.

Cord	Stop factor	Corrective Action
2BF	Memory read error Memory cannot be read.	Check/replace the operation panel.
2C1	Insufficient program setting	Operate after coming out of parameter setting screen/the other setting screens/manual operation screen.
2C6	Operation of the machine was performed during working of bobbin changer.	Do not operate the machine during working of bobbin changer.
2C7	Password requested Password is requested. The input password is wrong.	Input the password.
2CE	Stop by safety device Machine was stopped by the stop signal from the safety device.	After confirming safety, continue the operation of machine if needed.
2E2	Air pressure error Air pressure has become lower than the standard level.	Check/adjust the pressure of air supplying.
2E3	Power failure during operation The power supply was shut off during main shaft operation.	Turn ON the main power and perform the operation of power resume.
311-01	Encoder A signal error	Check the encoder signal lines. Check the excitation of the main shaft driver.
312-01	Encoder Z signal error	Check the encoder signal lines.
314	Main shaft revolution error	After checking around the rotary hook and the main shaft, remove the factor that the main shaft can not rotate.
316-01	Main shaft motor error	Turn OFF/ON the main power. Check/replace Main shaft motor /IDU amplifier.
321-01	Frame driver irregular signal	Lower the revolution of the main shaft. Check/replace the IDU amplifier /frame motor.
331	Abnormal signal of bobbin changer has been detected.	Operate the bobbin changer manually after resetting the error, and check/adjust the place where motion error occurred.
352	Sequin device IV driver error	Check/replace Head card C.
353	ESQ-C driver error	Check/replace Head card A and C.
361-04	Jump Driver signal error	Turn OFF/ON the main power. Lower the main shaft revolution. Check/replace Head card A.
382-01	Time to move to target position	Check/replace the color change motor/encoder and potentiometer (needle position sensor).

Cord	Stop factor	Corrective Action
383-01	Needle position error	Move the needle position within the set range. Check/replace the potentiometer (the needle position sensor) or the color change encoder.
384	One-turn signal is not detected	Check/replace the photo interrupter (1-rotation sensor) and color change encoder.
3A1-01	ATH Driver signal error	Turn OFF/ON the main power. Check/replace the thread trimming motor /joint 31 card.
3A6	Movable Knife Open	Check the position of ATH movable knife.
3AB	ATH thread separation error	Set the tension base SW at the detected head to the top and make LED lit green. Then press the reset key or start by the bar switch.
3AC	ATH Skip stitch error	
3B6	Communication error	Check/replace the high speed communication harness between CPU card and Head card.
3BE-**	Network communication error	Check the setting of network connection. Turn OFF/ON main power of machine and connecting device such as DG/ML. Check connecting cable.
3C1	Start/Stop switch error	Check/replace the connector/connection terminal/limit switch. Turn OFF/ON the main power.
3C2-01	Frame travel key error	Check/replace the frame moving switch. Turn ON the main power supply.
3D1	Battery signal error	Charge/replace the battery of the operation panel.
3D2	Battery signal error	Charge/replace the battery of CPU card.
3D9	Fan Motor error	Replace the fan motor for the power supply box/operation panel.
3DA	Permanent Counter error	Check/replace the connection of permanent counter.
3DC	Memory device error	Turn OFF/ON the main power. Install the system software. Check/replace CPU card.
3DD-**	System installation error	After pressing the reset key, install again by pressing the retry key. After turning OFF/ON the main power, install again. Check/replace CPU card.
5C3	Sequin device twin type setting error	Check/change the parameter setting of sequin device on operation panel.
5V6	General external device is operating.	Do not operate the machine during the operation of general external device.

Cord	Stop factor	Corrective Action
6B3-**	Logger communication error	Turn OFF/ON the main power. Check/replace the Logger card.
6B5-**	Communication error	Turn OFF/ON the main power. Install the system software. Check/replace each card.
6D4	SHT connection error	Connect the harness for SHT control.
OIL	Preset Halt Machine stopped by the preset halt (Lubrication) setting.	After lubricating the necessary spots, reset the machine by the reset key. Perform "Start operation" to continue the embroidery.
B01	Formatting error Abnormal format of storage media. Reading/writing error occurred.	After taking the backup, format the memory media. Use the new memory media.
B03	Write protect error The memory media is write-protected.	After cancelling the write-protection for memory media, perform the writing operation.
B04	Empty media error Media is not inserted.	Insert memory media.
BC1	Unregistered design No. Design No. is not found.	Perform the selection of design again.
BC3	Disk file error This memory media cannot be read.	After taking the backup, format the memory media. Use new memory media.

Cord	Stop factor	Corrective Action
BC4	Verify error Abnormal Stitch Data found on Media.	Perform writing again.
BC5	Memory capacity insufficient error	Replace with a memory media with enough remaining capacity. Then, by pressing the reset key, the operation will continue.

1-2. When the machine does not sew well

(1) Thread breakage

Cause	Corrective Action
Improper thread tension	Adjust tension. Upper thread (120 to 140 g), under thread (20 to 30 g)
Poor thread flow	Use silicone.
Direction of needle is bad or needle bents.	Adjust to face to the front or to the right a bit. Replace.
Applique glue is stuck on needle.	Remove adhered glue.
Lint, run-out of oil of rotary hook	Clean and lubricate.(→p.222)
Numerous tiny stitches of 0.5 mm or less in design data	Remove tiny stitch(es).(→p.89)
The fabric is lifted too much against the needle plate. The fabric touches the needle plate excessively.	Stretch the fabric again so that it touches needle plate lightly.
Run-out of oil of needle bar	Lubricate.(→p.226)
There is a scratch on the thread course and /or rotary hook.	Grind a scratch with sandpaper etc. Replace them.
Bad height of presser foot	Perform adjustment so that height fits to fabric/material.
The combination of Frame drive timing and embroidery condition is inappropriate.	Change setting.(→p.168)

(2) Needle breakage



Cause	Corrective Action
Improper thread tension	Adjust tension. Upper thread (120 to 140 g), under thread (20 to 30 g)
Density of design data is very high.	Correct data. Delete unnecessary underlay stitching.
The material is too thick or hard.	Use material suitable for embroidery.
Bobbin is deformed and it touches the needle.	Replace the bobbin.
Deterioration of needle, mis-matching to embroidery condition	Replace needle. Use needle that fits to condition.
Vibration of the machine is big.	Center support is too much touched to the table. Tighten the support by hand. Adjust leveling.
The combination of Frame drive timing and embroidery condition is inappropriate.	Change setting.(→p.168)

(3) Embroidery results not good



Cause	Corrective Action
Improper thread tension	Adjust tension. Upper thread (120 to 140 g), under thread (20 to 30 g)
Poor thread flow	Use silicone.
Density of design data does not match with material and/or thread.	Correct data.
Bad frame attaching and fixing of the fabric	Attach the frame correctly. Fix the fabric firmly.
The combination of thread, needle and/or the size of needle plate is inappropriate to the embroidery condition.	Make combination that fits to design data/material.
R.P.M. is too high.	Decrease R.P.M.
The combination of Frame drive timing and embroidery condition is inappropriate.	Change setting.(→p.168)

2. Maintenance

WARNING

-  Daily maintenance (cleaning, lubrication, greasing, inspection) should be performed by personnel who has been trained properly.
-  If the machine needs "repairs", the repairs must be done only by the service personnel assigned and trained by Tajima or qualified technician (consult your distributor.)
-  When starting operation again, attach all the detached covers as they originally were.

CAUTION

-  Perform daily maintenance. Neglect of daily maintenance could cause troubles. Damage due to neglect of daily maintenance may be judged as "Outside the scope of warranty".
-  If the machine is not used for a long period, turn the power switch ON in regular intervals. Although each card of the machine has a backup battery, data may be lost for about one month because voltage of the battery will come down gradually due to discharge when power switch is turned off.
-  Assure enough illumination. Assure 300 lux or more for working areas including underneath part of the machine table when changing under threads or performing daily maintenance.

2-1. Cleaning

WARNING

- ! When performing cleaning, be sure to turn OFF the power switch. You could be injured seriously by being entangled in the machine.

Clean each section by using a cleaning tool or an air compressor, etc. on the market.

(1) Rotary hook, ATH

Cleaning cycle: Every day

Use an air compressor.

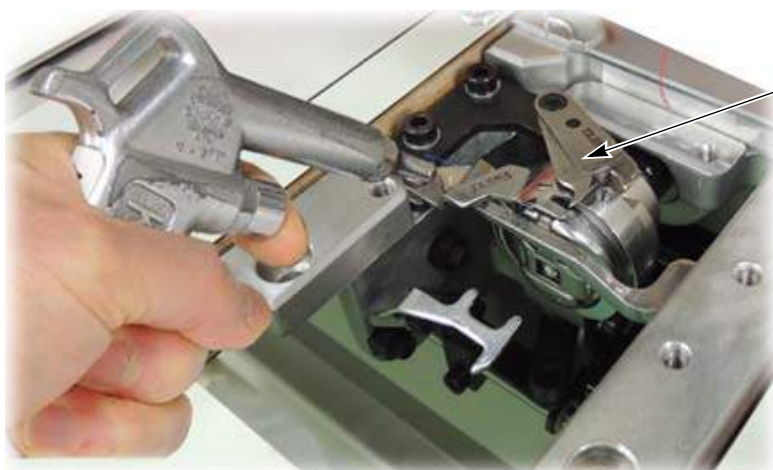

Movable knife

Before cleaning ATH, open the movable knife by operation on the operation panel. (→p.74)

Then, after turning OFF the power, clean each section by using a cleaning tool or an air compressor, etc. on the market.

Use a cleaner.

Brush (accessory)



Cleaner

(2) 1st tension, head

Cleaning cycle: Once/week

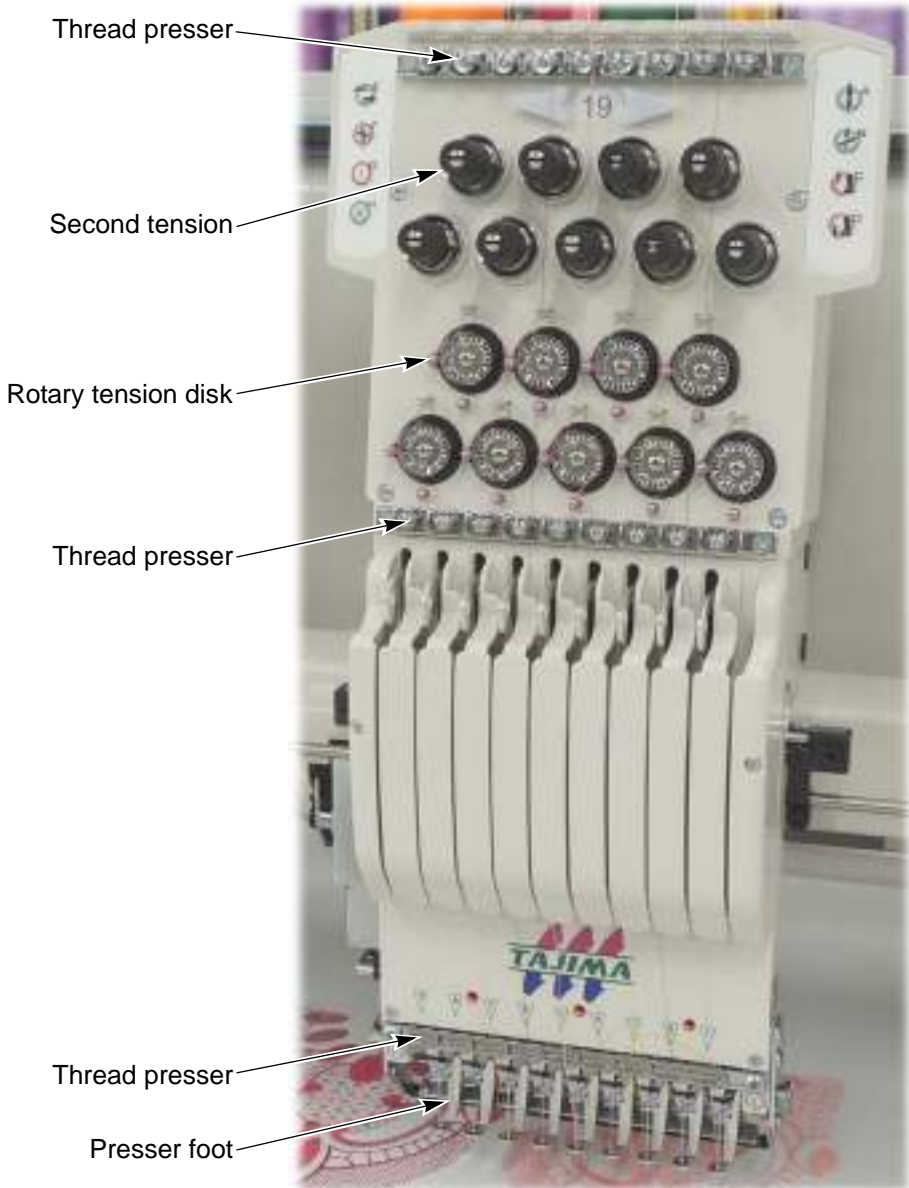

(3) X-axis drive system, Y-axis drive system

Cleaning cycle: Once/week

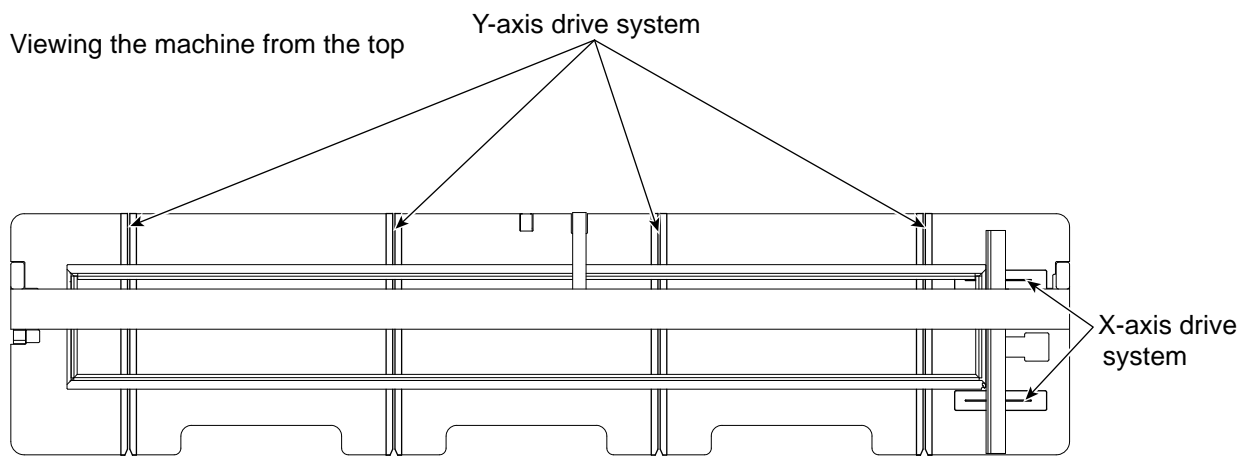

Use an air compressor.



(4) Filter (Controller)

Cleaning cycle: Once/week

When you neglect to clean filter, inside temperature could become higher due to clogging to cause malfunctioning.

Regarding cleaning of filter, usually use a cleaner to vacuum up dust. When the filter is contaminated too much (by oil spots, powder dust etc.), it is also possible to perform water washing using neutral detergent. However, dry the filter thoroughly after washing.

Since filter is a consumable, replace it periodically.

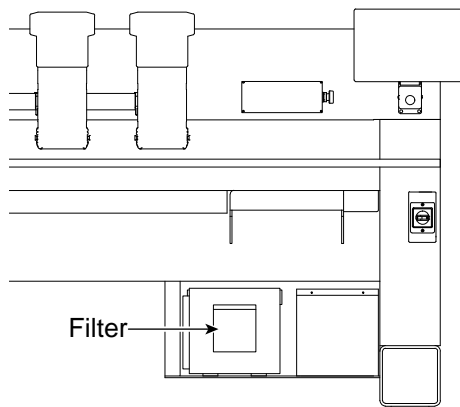

How to detach the filter

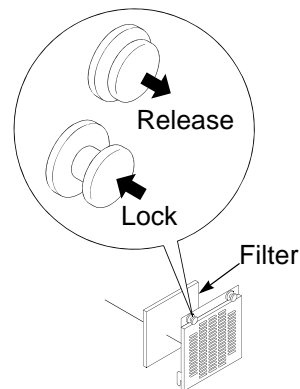

2-2. Lubrication

WARNING

- ! To perform lubrication, turn OFF the power switch. You may sustain severe injuries by being caught in the machine.

CAUTION

- ! Use only Tajima's genuine TF oil or equivalent (Viscosity grade = VG20).

(1) Rotary hook

Lubrication cycle: Once/5 to 6 hours

To lubricate, use the oiler. There are two lubricating spots, raceway and lubrication hole.

Oiler (accessory)

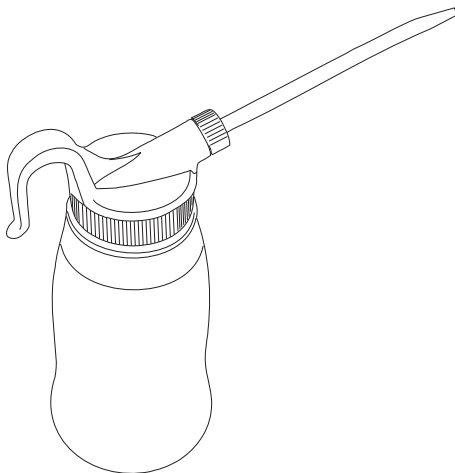

Raceway

Lubrication hole (red mark)



To lubricate lubrication hole, attach the nozzle (accessory) to the tip of the oiler.



Nozzle

(2) Head

Lubrication cycle: Once/week

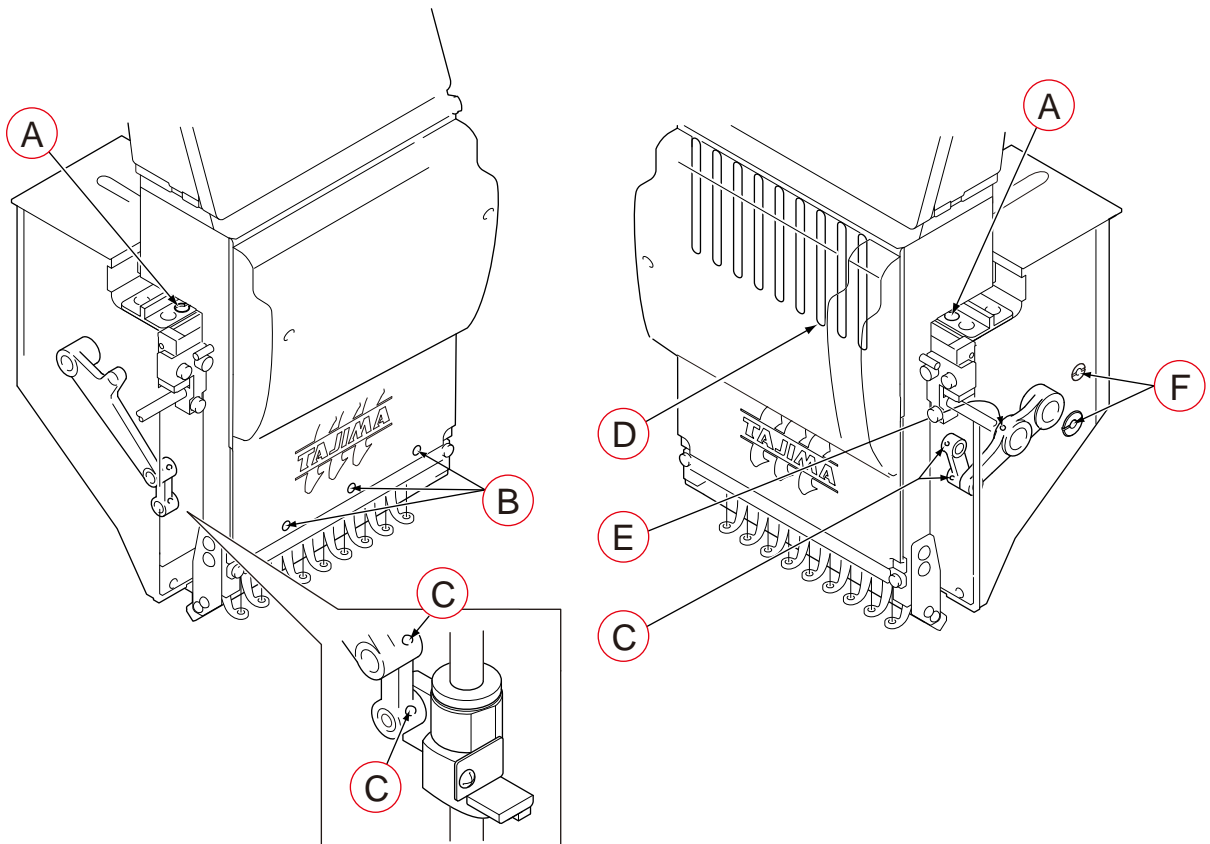

	Lubricating spot
A	Needle bar drive shaft (Either one spot)
B	Needle bar (spot indicated by red mark)
C	Lubrication hole of connecting part
D	Needle bar (all needles)
E	Lubrication hole of needle bar lever
F	Wick of stepped pin

2-3. Greasing

When you perform greasing, consult the distributor.

WARNING

- ! During machine greasing, turn OFF the power switch. You may sustain severe injuries due to being entangled by moving machine units.

CAUTION

- ! Use a grease specified(described below) by TAJIMA or equivalent to keep the lubricity inside of the head normally. Use of the grease except these could cause trouble due to deterioration of the lubricity. Regarding how to obtain it, consult the distributor.

[Items specified by TAJIMA]

Part name	Item No.	Base oil	Thickener
KING STAR EP NO.2: 400G	750103004000	Refined mineral oil (about 75%)	Lithium soap (about 15%)
NIG LUBE PG: 300ML	750104001000	Olefinic synthetic oil	Lithium soap

Grease manufacturer: NIPPON GREASE Co.,Ltd.

URL: <http://www.nippon-grease.co.jp/>

(1) Rotary hook base

Grease to use: KING STAR EP NO.2: 400G

Greasing cycle: Once/6 months

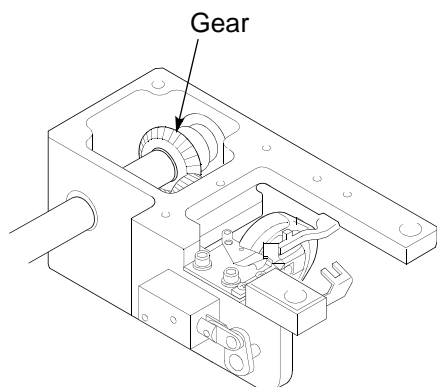

(2) Head

Greasing cycle: Once/3 months

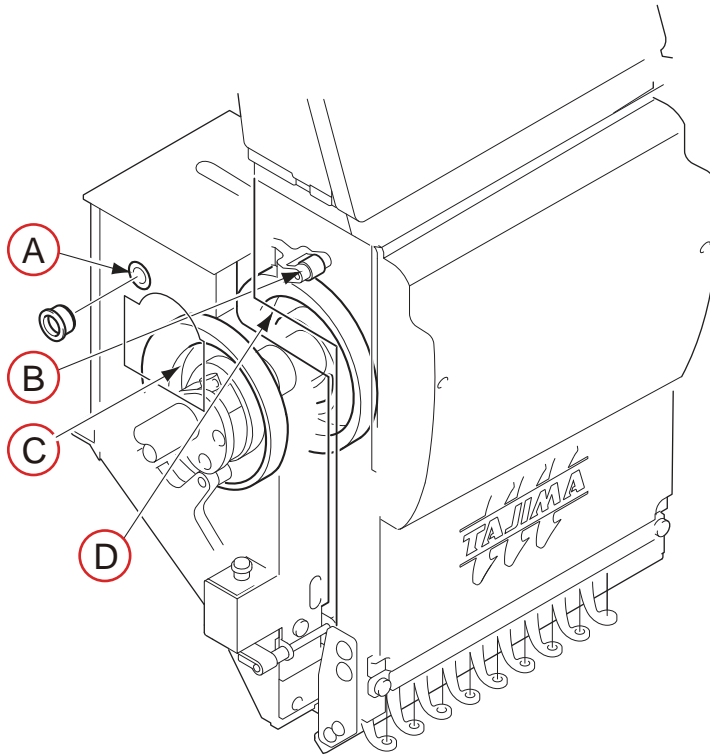

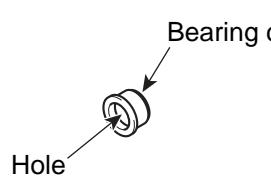
	Greasing spot	Grease to use
A	Take-up lever shaft holder (Right/left)  Inject grease from the hole of the bearing case lid by using the syringe.	NIG LUBE PG: 300ML
B	Take-up lever drive lever roller	
C	Presser foot cam	
D	Take-up lever cam	

2-4. Inspection

WARNING

 Be sure to turn off the main power supply before working. Even if the main power supply is turned off, some circuits are still applied voltage. Wait until they are not applied voltage completely (4 minutes), and then start working.

Inspection point	Contents of inspection	Inspection cycle
Each belt in main shaft drive system	Tension of belt, degree of wear, existence of crack	Once/3 months
X- and Y-axis drive belts	Tension of belt, degree of wear, existence of crack	
Rotating, sliding section	Degree of wear	

2-5. Repair

WARNING

 If the machine needs repairs, the repairs must be done only by the service personnel assigned and trained by Tajima or qualified technician. (consult your distributor.) Do not change the specification nor modify the parts of the machine without due consultation with Tajima. Such modification may risk the operational safety.

 Be sure to turn off the main power supply before working. Even if the main power supply is turned off, some circuits are still applied voltage. Wait until they are not applied voltage completely (4 minutes), and then start working.

 When restarting the machine after repairs, attach all removed covers etc. as they were.

CAUTION

 For the machine repairs, use TAJIMA genuine parts for replacement.

3. Items to notice when attaching tension base cover

! CAUTION

! When attaching the tension base cover, pull out the harness so that the mark tube comes out. Otherwise, the tension base card could be damaged.

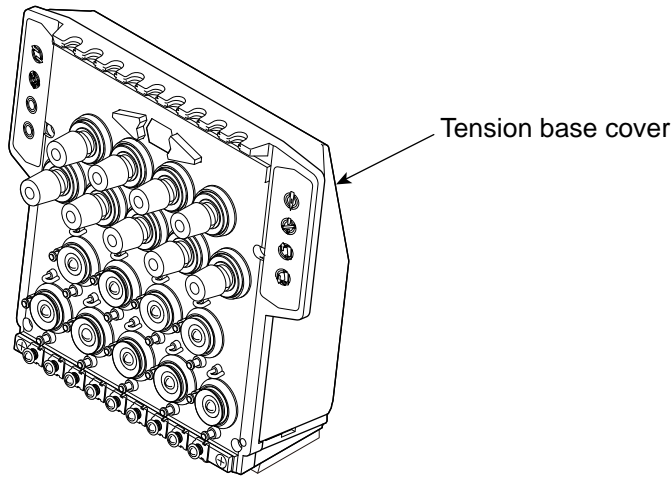

(1) The tension base cover is detached.

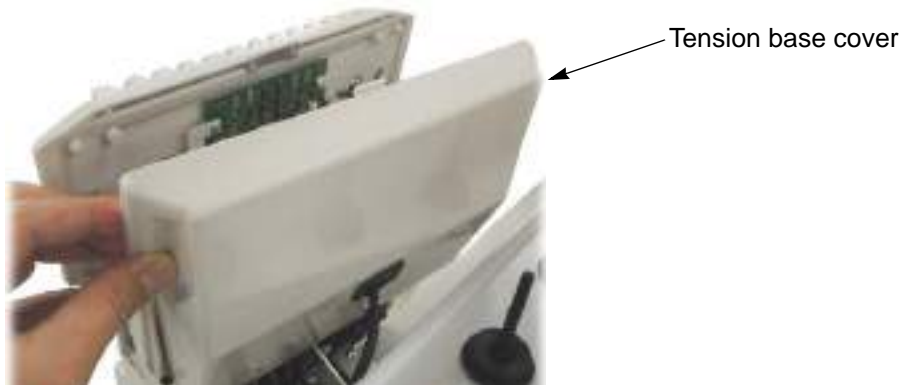

(2) When attaching the tension base cover, pull out the harness so that the mark tube comes out of the grommet.

Good example

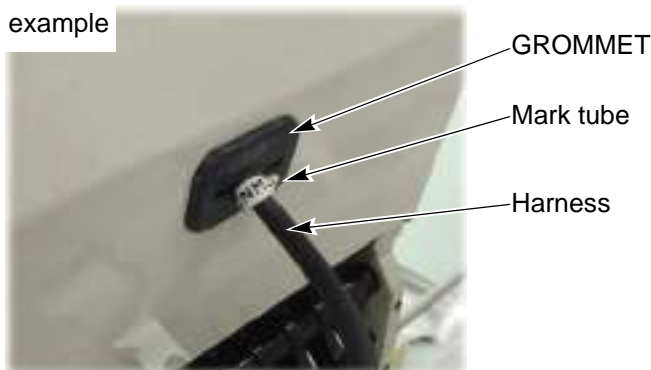

Bad example



4. Adjustment of Snap-fit middle thread guide

To adjust the stroke amount of the thread take-up spring inside the snap-fit middle thread guide, follow the procedure below.

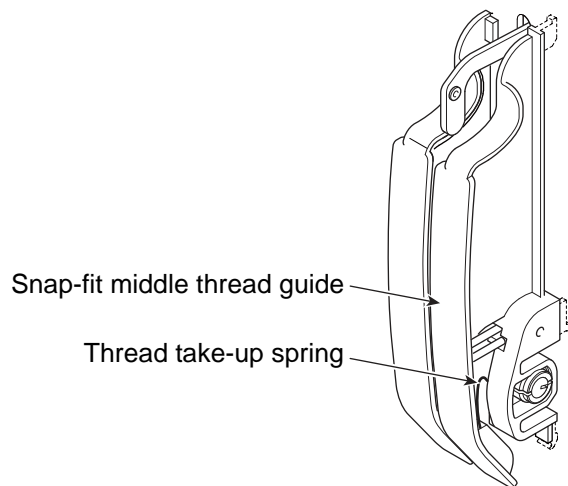

[How to adjust]

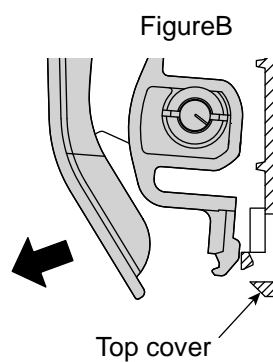
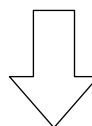
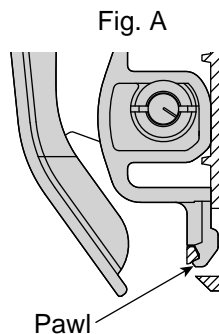

- (1) Push the pawl with some thin-tipped stick (Fig. A), and release the pawl from the top cover and pull it to the front (Fig. B).

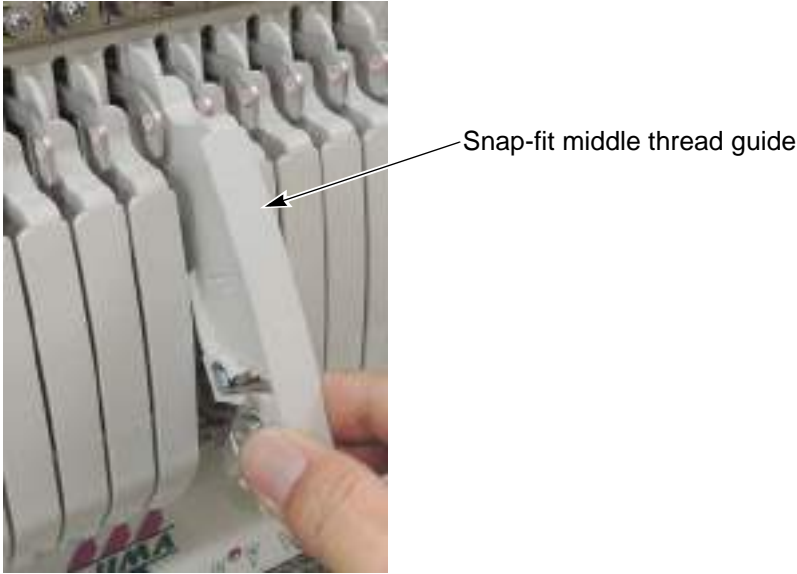

(2) Detach the snap-fit middle thread guide.

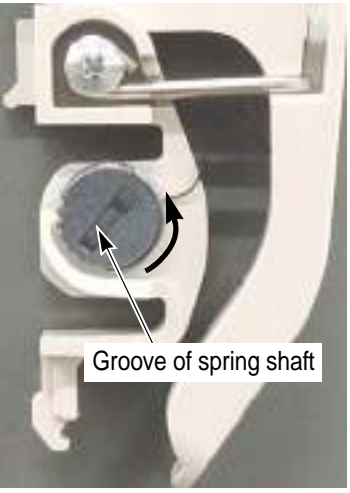

(3) To adjust stroke of the thread take-up spring, put some coin, etc. in the groove of the spring shaft and turn the spring shaft.

Minimum stroke	Standard stroke	Maximum stroke
Click three times in the counterclockwise direction	Position at shipment from the factory	Click twice in the clockwise direction
		

- (4) Put the pawl in the slit (Photo A), push up the locking pawl with your thumb and put it in the hole (Photo B).

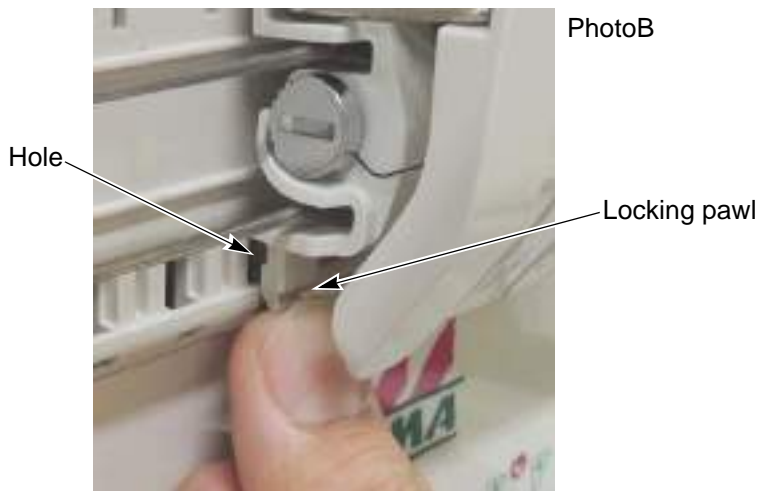
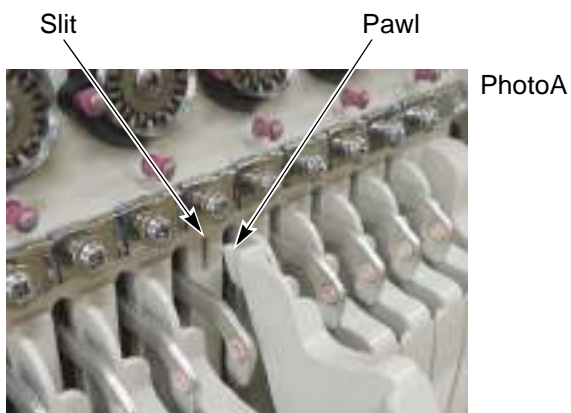

- (5) Push the snap-fit middle thread guide securely to fit until it clicks into place.

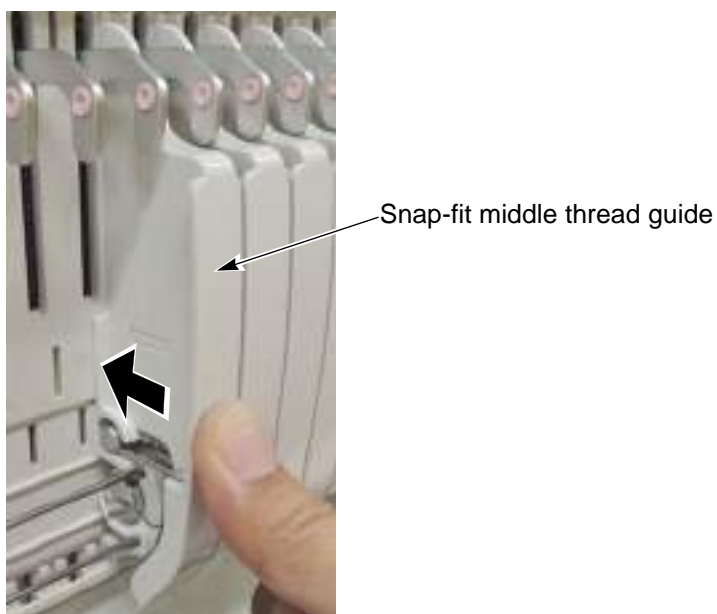

5. Upgrading of software (Input of a password is necessary)

The latest software at shipment is installed to the machine. When upgrading of the software is necessary in later use, install the latest software according to the following procedure.

Regarding the contents and how to obtain the latest software, please consult the distributor.

To perform this work, input of the password is necessary. After input of the password, the following operation will become possible until you turn ON the power again next time. For details, consult the distributor.

[Explanation of screen]

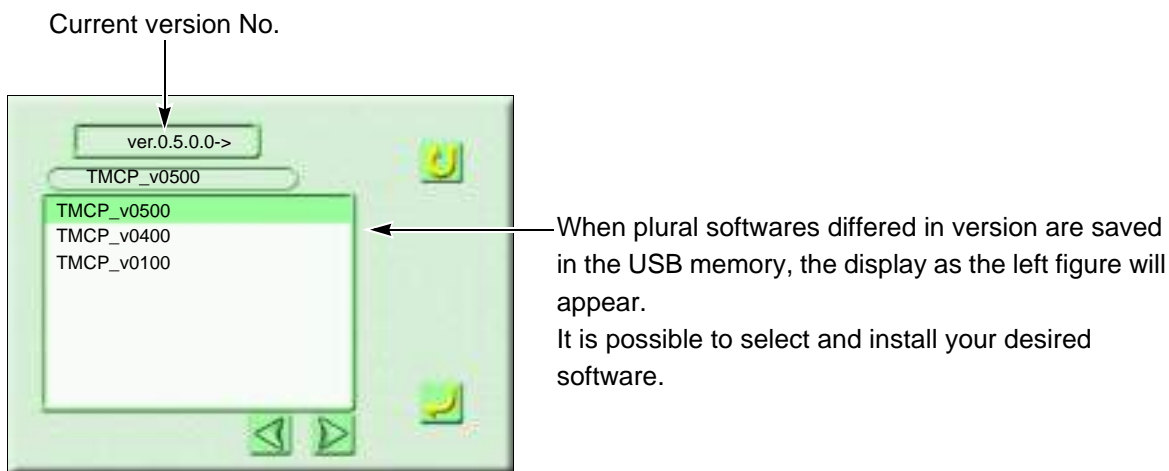

[How to operate]

(1) To set USB memory

USB memory in which software is saved

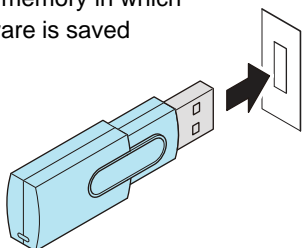

(2) Icon G

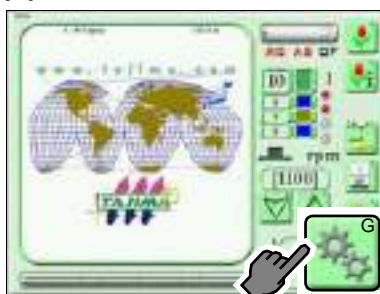

(3) Press P6 twice.

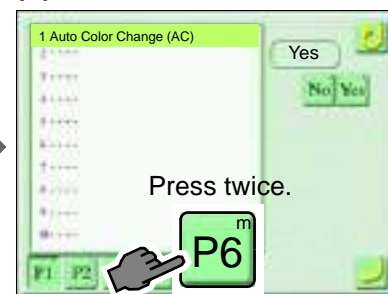

(4) Icon S

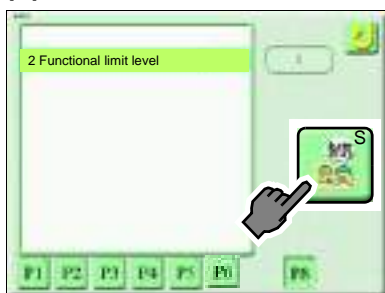

(5) Input a password.



(6) To set



(7) SEL

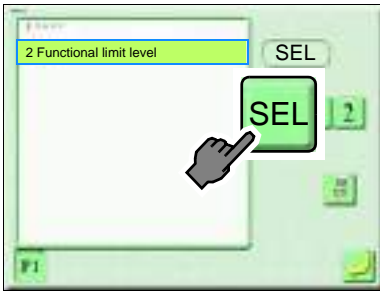

(8) Icon T

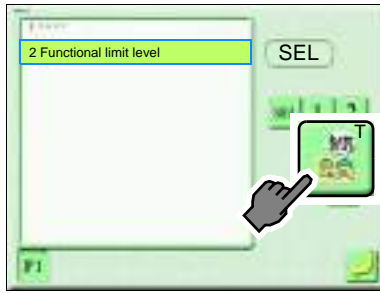

(9) Icon T

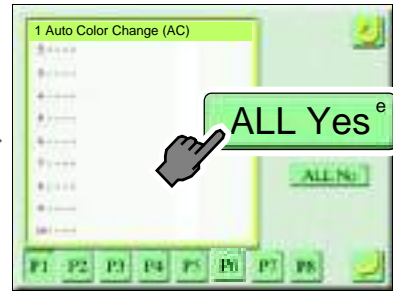

(10) To set

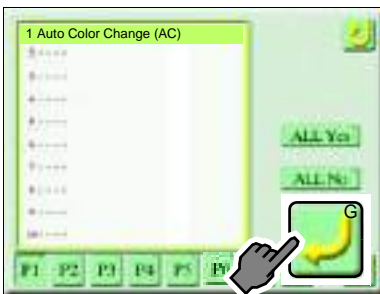

(11) To set

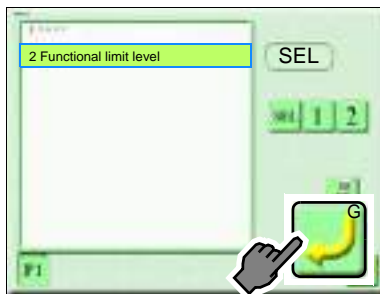

(12) Icon A

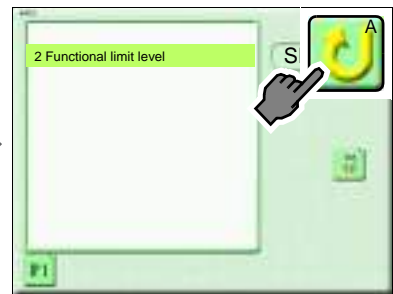

(13) 85 Machine adjustment

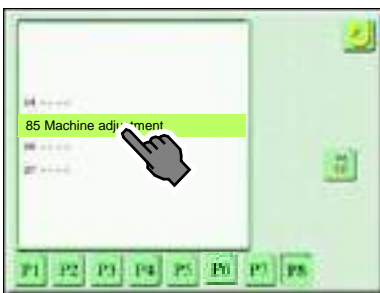

(14) Icon T

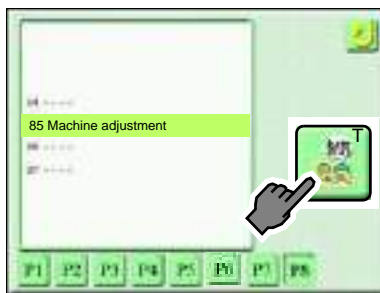

(15) P2

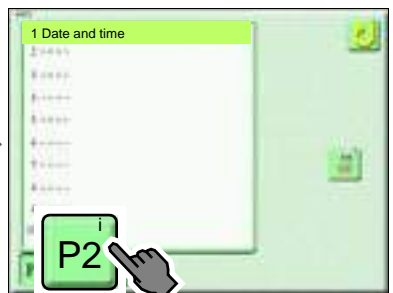

(16) 15 Software install



(17) Icon T

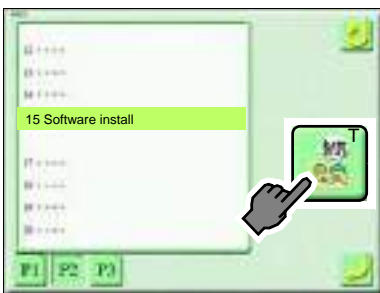

(18) To set



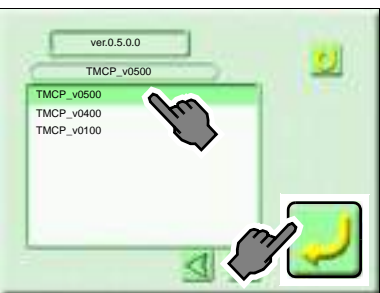

(19) A desired software to set

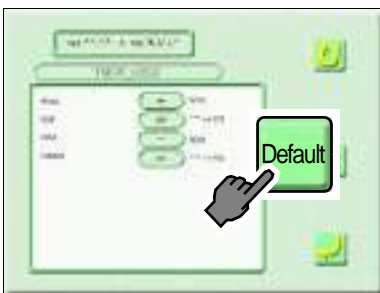

(20) Default (Recommended)



-  Install only the necessary system.
-  Install all systems. When overwriting the same software, select this icon.

(21)To set

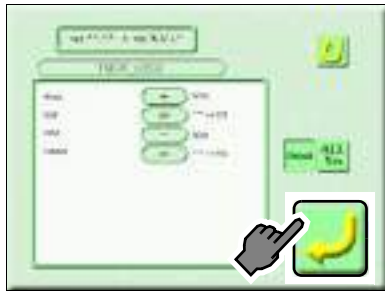

Now processing



Now processing

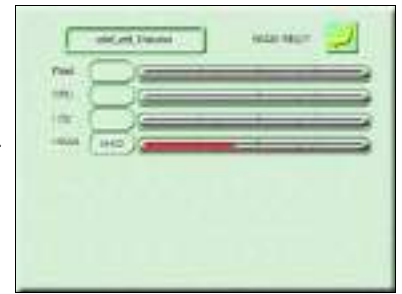

(22)Completed.



(23)Pull out the USB memory.

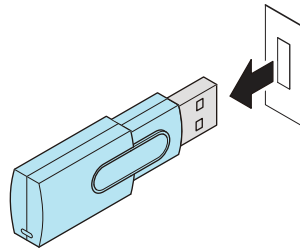

(24)Turn OFF and ON the power. At this moment, wait for twenty seconds or more.

Chapter 12

Appendix

- 1. Specification of the machine..... 240
- 2. Electrical system diagram (3-phase 200 to 220 V)..... 241
- 3. Dip switch setting..... 247
- 4. Terminology 254

1. Specification of the machine

1-1. Electrical specifications

Allowable voltage range	Within $\pm 10\%$ of the rated voltage
Frequency	50 / 60 Hz
Apparent power	2.1 kVA
Active power	1.2 kW
Insulated resistance	10 M ohms or greater (500 megger insulation tester)

Values described in the above table are maximum values of apparent power and active power including that of LED light. They do not include that of the optional device.

1-2. Ambient noise level

The ambient noise level of the machine is less than 85 dB. Measuring conditions are as follows.

Measuring ambience	Refer to the figure below.
Measuring position	Measured at the position A which height is 1.6 m from the floor and the distance is 0.3 m from the front of the operation panel
Working machine condition	Fabric is stretched on the tubular goods frame or the border frame, and embroidered a design which has 2 mm width.
RPM	Maximum number of revolutions of machine
Measuring instrument	Conformity to IEC61672-1: 2002 Class 1

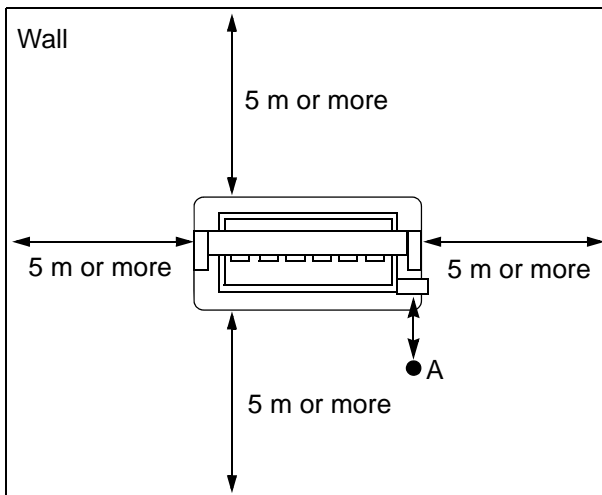

1-3. Machine weight

Machine weight is described on the spec. plate. (→p.10)

2. Electrical system diagram (3-phase 200 to 220 V)

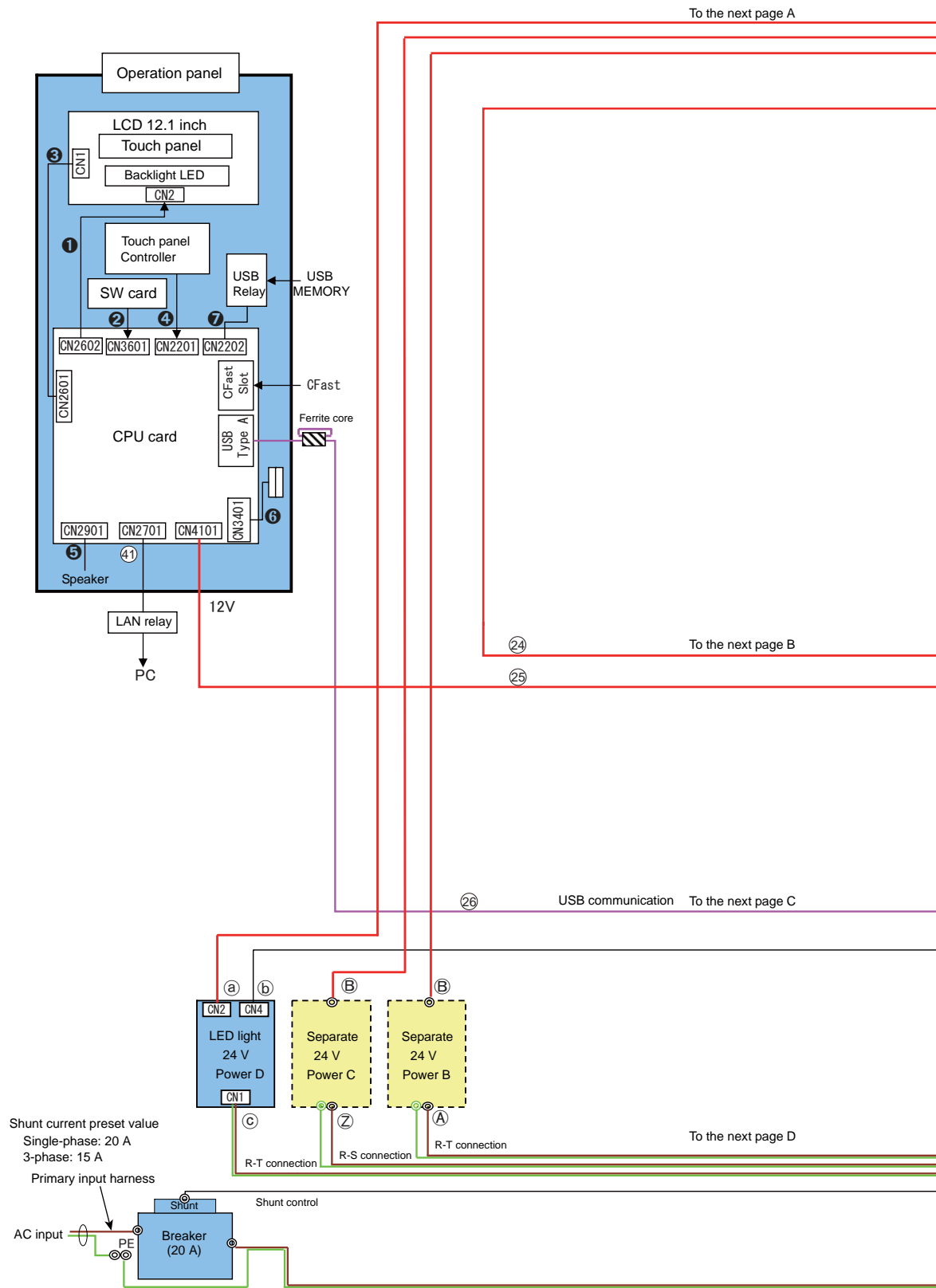

LED light (The number of lights depends on the size of the model, and it is up to six lights.)

A 1st light ----- Last light To the next page A

To CNA10 of next head card A

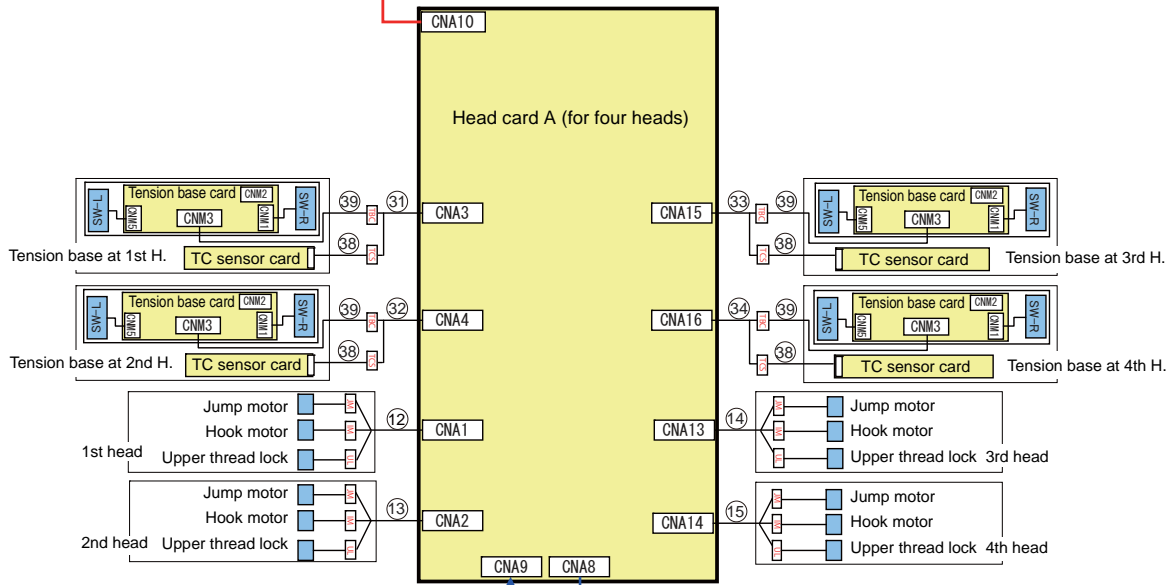

B

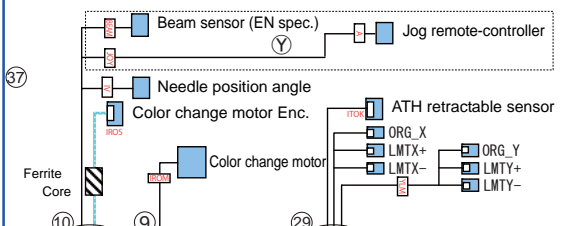

C

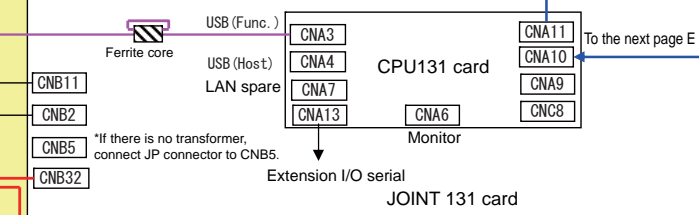

D

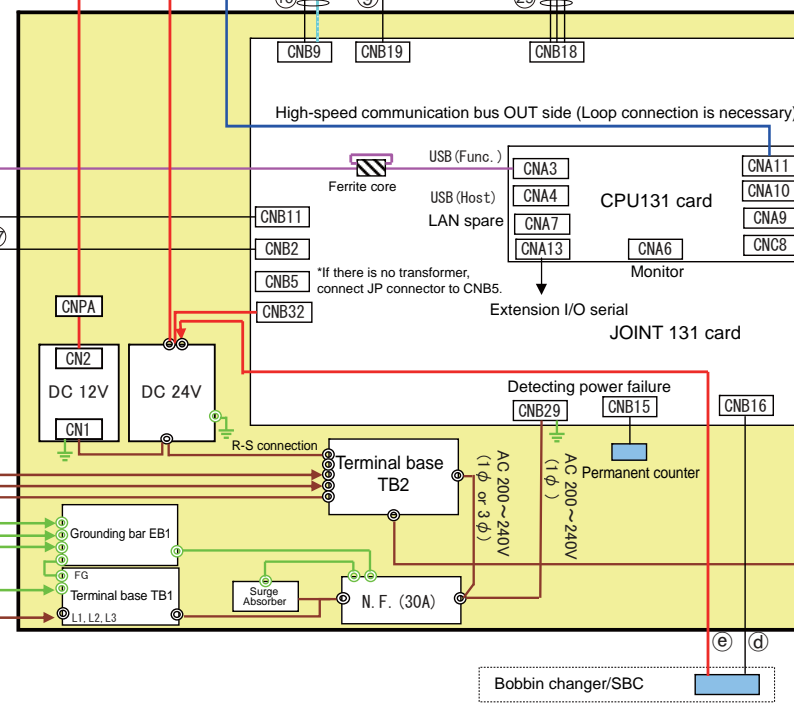

To the next page E

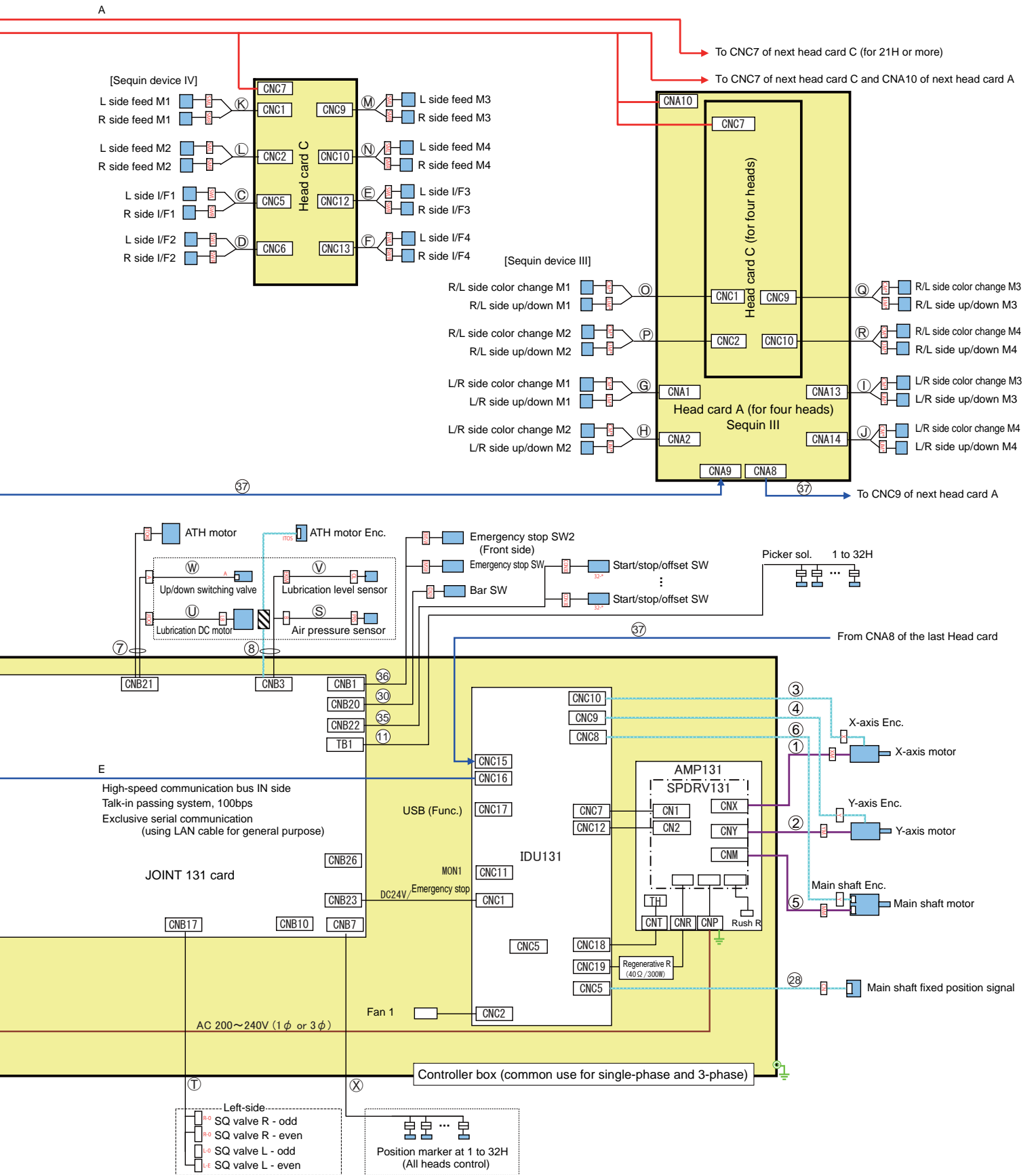

Standard spec.

No.	Part Name	No.	Part Name
①	HARNESS :BACKLIGHT :LCD	②⑧	HARNESS :MAIN SHAFT FIXED POSITION
②	HARNESS :OPERATION PANEL SWITCH :PANEL	②⑨	HARNESS : FRAME LIMIT/ATH RETRACTABLE SENSOR
③	HARNESS :PANEL :LVDS	③⑩	HARNESS :BAR SWITCH
④	HARNESS :TOUCH :OPERATION PANEL	③①	HARNESS :TENSION BASE RELAY :1
⑤	SPEAKER :OPERATION PANEL	③②	HARNESS :TENSION BASE RELAY :2
⑥	HARNESS :SERIAL COMMUNICATION :OPERATION PANEL :RELAY	③③	HARNESS :TENSION BASE RELAY :3
⑦	HARNESS :USB :OPERATION PANEL	③④	HARNESS :TENSION BASE RELAY :4
①	HARNESS :X-AXIS MOTOR	③⑤	HARNESS :START/STOP SWITCH :JUMPER ^[1]
②	HARNESS :Y-AXIS MOTOR		HARNESS :START/STOP/OFFSET SWITCH :1 ^[2]
③	HARNESS :X-AXIS ENCODER		HARNESS :START/STOP/OFFSET SWITCH :2 ^[3]
④	HARNESS :Y-AXIS ENCODER		HARNESS :START/STOP/OFFSET SWITCH :3 ^[4]
⑤	HARNESS :MAIN SHAFT MOTOR		HARNESS :START/STOP/OFFSET SWITCH :4 ^[5]
⑥	HARNESS :MAIN SHAFT ENCODER		HARNESS :START/STOP/OFFSET SWITCH :5 ^[6]
⑦	HARNESS :THREAD TRIMMING MOTOR		HARNESS :START/STOP/OFFSET SWITCH :6 ^[7]
⑧	HARNESS :THREAD TRIMMING ENCODER		HARNESS :START/STOP/OFFSET SWITCH :7 ^[8]
⑨	HARNESS :COLOR CHANGE MOTOR	③⑥	HARNESS :EMERGENCY STOP SW :1
⑩	HARNESS :COLOR CHANGE ENCODER/NEEDLE POSITION/JOG REMOTE-CONTROLLER		HARNESS :EMERGENCY STOP SW :2
⑪	HARNESS :PICKER	③⑦	HARNESS :LAN
⑫	HARNESS :HOOK/JUMP/LOCK :1	③⑧	HARNESS :TC SENSOR
⑬	HARNESS :HOOK/JUMP/LOCK :2	③⑨	HARNESS :TENSION BASE
⑭	HARNESS :HOOK/JUMP/LOCK :3	④①	HARNESS :LAN CABLE :3M
⑮	HARNESS :HOOK/JUMP/LOCK :4		
⑲	HARNESS :HEAD CARD POWER SUPPLY :DC24V		
⑳	HARNESS :OPERATION PANEL POWER SUPPLY		
㉑	HARNESS : OPERATION PANEL COMMUNICATION		
㉒	HARNESS :SHUNT		

- [1] Without SW Box
- [2] SW Box 1 piece spec.
- [3] SW Box 2 pieces spec.
- [4] SW Box 3 pieces spec.
- [5] SW Box 4 pieces spec.
- [6] SW Box 5 pieces spec.
- [7] SW Box 6 pieces spec.
- [8] SW Box 7 pieces spec.

LED light

No.	Part Name
(a)	HARNESS :LED LAMP POWER SUPPLY :DC24V
(b)	HARNESS :REMOTE :LED LAMP
(c)	HARNESS :INPUT AC :LED LAMP DC POWER SUPPLY ^[1]

UBC2 / SBC

No.	Part Name
(d)	HARNESS :UBC MACHINE I/F
(e)	HARNESS :UBC TERMINAL BASE POWER SUPPLY :ROUND TERMINAL

Sequin Device III

No.	Part Name
(A)	HARNESS :EXTERNAL I/O POWER SUPPLY ^[2]
(Z)	HARNESS :EXTERNAL I/O POWER SUPPLY 2 ^[3]
(B)	HARNESS :HEAD CARD POWER SUPPLY :DC24V :4
(C)	HARNESS :SWITCH RELAY :L :1
(D)	HARNESS :SWITCH RELAY :L :2
(E)	HARNESS :SWITCH RELAY :L :3
(F)	HARNESS :SWITCH RELAY :L :4
(G)	HARNESS :A :UP/DOWN/COLOR CHANGE :L :1
(H)	HARNESS :A :UP/DOWN/COLOR CHANGE :L :2
(I)	HARNESS :A :UP/DOWN/COLOR CHANGE :L :3
(J)	HARNESS :A :UP/DOWN/COLOR CHANGE :L :4
(K)	HARNESS :FEED MOTOR :L :1
(L)	HARNESS :FEED MOTOR :L :2
(M)	HARNESS :FEED MOTOR :L :4
(N)	HARNESS :FEED MOTOR :L :5
(C)	HARNESS :SWITCH RELAY :R :1
(D)	HARNESS :SWITCH RELAY :R :2
(E)	HARNESS :SWITCH RELAY :R :3
(F)	HARNESS :SWITCH RELAY :R :4
(G)	HARNESS :A :UP/DOWN/COLOR CHANGE :R :1
(H)	HARNESS :A :UP/DOWN/COLOR CHANGE :R :2
(I)	HARNESS :A :UP/DOWN/COLOR CHANGE :R :3
(J)	HARNESS :A :UP/DOWN/COLOR CHANGE :R :4
(K)	HARNESS :FEED MOTOR :R :1

No.	Part Name
(L)	HARNESS :FEED MOTOR :R :2
(M)	HARNESS :FEED MOTOR :R :4
(N)	HARNESS :FEED MOTOR :R :5
(C)	HARNESS :SWITCH RELAY :LR :1
(D)	HARNESS :SWITCH RELAY :LR :2
(E)	HARNESS :SWITCH RELAY :LR :3
(F)	HARNESS :SWITCH RELAY :LR :4
(G)	HARNESS :A :UP/DOWN/COLOR CHANGE :L :1
(H)	HARNESS :A :UP/DOWN/COLOR CHANGE :L :2
(I)	HARNESS :A :UP/DOWN/COLOR CHANGE :L :3
(J)	HARNESS :A :UP/DOWN/COLOR CHANGE :L :4
(O)	HARNESS :C :UP/DOWN/COLOR CHANGE :R :1
(P)	HARNESS :C :UP/DOWN/COLOR CHANGE :R :2
(Q)	HARNESS :C :UP/DOWN/COLOR CHANGE :R :3
(R)	HARNESS :C :UP/DOWN/COLOR CHANGE :R :4
(K)	HARNESS :FEED MOTOR :LR :1
(L)	HARNESS :FEED MOTOR :LR :2
(M)	HARNESS :FEED MOTOR :LR :4
(N)	HARNESS :FEED MOTOR :LR :5

[1] S-T connection

[2] R-T connection for 9 to 20H

[3] R-S connection for 21H or more

Sequin device IV

No.	Part Name
Ⓐ	HARNESS :EXTERNAL I/O POWER SUPPLY ^[1]
Ⓒ	HARNESS :EXTERNAL I/O POWER SUPPLY 2 ^[2]
Ⓑ	HARNESS :HEAD CARD POWER SUPPLY :DC24V :3
Ⓢ	HARNESS :THREAD TRIMMING ENCODER/LB/ AIR PRESSURE SENSOR
Ⓣ	HARNESS :AIR PRESSURE SENSOR
Ⓚ	HARNESS :FEED MOTOR :L :1
Ⓛ	HARNESS :FEED MOTOR :L :2
Ⓜ	HARNESS :FEED MOTOR :L :4
Ⓝ	HARNESS :FEED MOTOR :L :5
Ⓣ	HARNESS :AIR VALVE :S :L ^[3]
	HARNESS :AIR VALVE :W :L ^[4]
Ⓚ	HARNESS :FEED MOTOR :R :1
Ⓛ	HARNESS :FEED MOTOR :R :2
Ⓜ	HARNESS :FEED MOTOR :R :4
Ⓝ	HARNESS :FEED MOTOR :R :5
Ⓣ	HARNESS :AIR VALVE :S :R ^[3]
	HARNESS :AIR VALVE :W :R ^[4]
Ⓚ	HARNESS :FEED MOTOR :LR :1
Ⓛ	HARNESS :FEED MOTOR :LR :2
Ⓜ	HARNESS :FEED MOTOR :LR :4
Ⓝ	HARNESS :FEED MOTOR :LR :5
Ⓣ	HARNESS :AIR VALVE :S :LR ^[3]
	HARNESS :AIR VALVE :W :LR ^[4]

Position marker

No.	Part Name
ⓧ	HARNESS :POSITION MARKER

Jog remote-controller

No.	Part Name
Ⓨ	HARNESS :JOG REMOTE-CONTROLLER EXTENSION

[1] R-T connection for 9 to 20H

[2] R-S connection for 21H or more

[3] When frame spec. is "S"

[4] When frame spec. is other than "S"

[5] Lubrication only for upper/lower position

Automatic lubrication

No.	Part Name
⑦	HARNESS :THREAD TRIMMING MOTOR/LUBRICATOR PUMP
⑧	HARNESS :THREAD TRIMMING ENCODER/LB/ AIR PRESSURE SENSOR
Ⓤ	HARNESS :LUBRICATING MOTOR
Ⓥ	HARNESS :OIL LEVEL SWITCH
Ⓦ	HARNESS :UPPER AND LOWER SPLIT VALVE ^[5]

3. Dip switch setting

The third digit of card name varies depending on card type.

Example: IDU-131 card



Example: Head 131-A card



3-1. IDU-13*card

IDU-13*card is located to the front inside the controller box.

(1) SWC1

DIP switch	No.	Description	Setting contents	OFF	ON	Setting at shipment
	1	S 1.5K / 750	Output of main shaft motor	1.5 kw	750W	[1]
	2	—	Not used	—	—	OFF
	3	—	Not used	—	—	OFF
	4	—	Not used	—	—	OFF
	5	—	Not used	—	—	OFF
	6	X CCW / CW	Rotating direction of X-axis motor	CCW	CW	[2]
	7	Y CCW / CW	Rotating direction of Y-axis motor	CCW	CW	ON
	8	S CCW / CW	Rotating direction of main shaft motor	CCW	CW	OFF

[1] Standard model or more: OFF(1.5kW), Small model: ON(750W)

[2] Ball-screw type: OFF (CCW), Timing belt type: ON (CW)

(2) SWC2

DIP switch	No.	Description	Setting contents	OFF	ON	Setting at shipment
	1	—	Unable to use	—	—	OFF ^[1]
	2	—	Unable to use	—	—	OFF ^[1]

[1] Always set to "OFF".

3-2. CPU-13*Card

CPU-13*card is located on the rear side of the controller box.

(1) SWA1

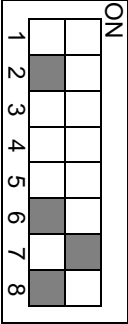
DIP switch	No.	Label description	Setting contents	OFF	ON	Setting at shipment
	1	/ Ext. Control	Safety device	Without	With	[1]
	2	/ Y pos. Correct	Correction of Y-axis position	Without	With	OFF ^[2]
	3	/ JOG R. Control	Jog remote-controller	Without	With	[1]
	4	X Screw / Belt	X-axis drive method	Ball screw	Belt	[1]
	5	S 2.4 : 1 / 3 : 1	Main shaft pulley ratio	2.4 : 1	3 : 1	[3]
	6	—	Unable to use	—	—	OFF ^[4]
	7	/ F. W. Data	Frame data processing at power ON	Initialization	Adjusting to applicable models	ON ^[5]
	8	—	Frame measurement	Normal mode	Frame measurement mode	OFF ^[6]

[1] Select OFF/ON depending on the presence/absence of safety device (beam sensor) and specifications.

[2] It is normally OFF.

[3] Standard model or more: OFF(2.4 : 1), Small model: ON(3 : 1)

[4] Turn it OFF. It cannot be started by turning it ON.

[5] It is normally ON.

[6] It is normally OFF.

(2) SWA2

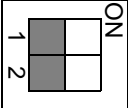
DIP switch	No.	Label description	Setting contents	OFF	ON	Setting at shipment
	1	—	Unable to use	—	—	OFF ^[1]
	2	—	Unable to use	—	—	OFF ^[1]

[1] Always set to "OFF".

3-3. Head 13*card

Head 13*card (1 pce necessary per 4 heads) is located on the rear side of square pipe. Head 13*card used in the machine is in the following types.

Head 13*-A card (A in the table below)

Head 13*-C card (C in the table below)

The mounted "Head 13* card" is different in the number and the composition depending on the specifications.

	Standard	
	Right-side	Left-side
Without Sequin IV, ESQ-C	—	A, B
With Sequin IV	—	A, B, C
With ESQ-C (Single-side)	A	A, B, C
With ESQ-C (both sides) ^[1]	A, C	A, B, C

[1] Example of attaching Head 13*card in case of "With ESQ-C (both sides)"

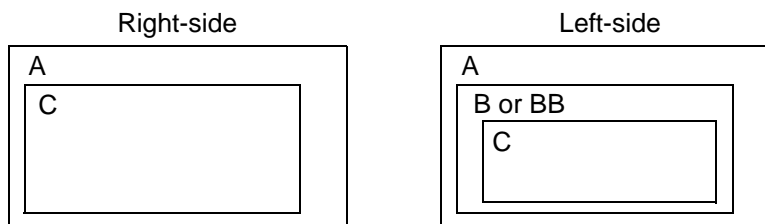

[Head 13*-A card] (Left-side)

(1) SWA1

DIP switch	No.	Setting contents	OFF	ON	Setting at shipment
	1	Not used	—	—	OFF ^[1]
	2	Not used	—	—	OFF ^[1]
	3	Not used	—	—	OFF ^[1]
	4	Not used	—	—	OFF ^[1]

[1] Always set to "OFF".

(2) SWA2

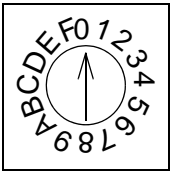
DIP switch	No.	Setting contents	Setting at shipment
	0	Standard head	0 [1]
	1	ESQ-C	
	2 to F	Not used	

[1] Always set to "0".

(3) SWA3

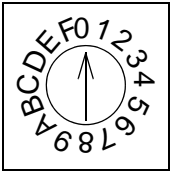
DIP switch	No.	Setting contents	
	0	Control head (Card ID)	1st H to 4th H
	1		5th H to 8th H
	2		9th H to 12nd H
	3		13th H to 16th H
	4		17th H to 20th H
	5		21st H to 24th H
	6		25th H to 28th H
	7		29th H to 30th H
	8 to F		Not used

(4) SWA4

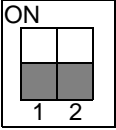
DIP switch	No.	Setting contents	OFF	ON	Setting at shipment
	1	Unable to use	—	—	OFF ^[1]
	2	Unable to use	—	—	OFF ^[1]

[1] Always set to "OFF".

(5) SWA5

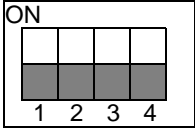
DIP switch	No.	Setting contents	OFF	ON	Setting at shipment
	1	Not used	—	—	OFF ^[1]
	2	Not used	—	—	OFF ^[1]
	3	Not used	—	—	OFF ^[1]
	4	Not used	—	—	OFF ^[1]

[1] Always set to "OFF".

[Head 13*-A card] (Right-side)

When purchasing Head 13*-A card, DIP switch has been set to "OFF" or "0". Therefore, it is necessary to switch the DIP switch setting.

(1) SWA1

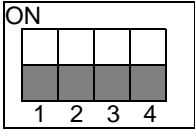
DIP switch	No.	Setting contents	OFF	ON	Setting at shipment
	1	Not used	—	—	OFF
	2	Not used	—	—	OFF
	3	Not used	—	—	OFF
	4	ESQ-C	Right side	Left side Both sides	[1]

[1] Select OFF/ON depending on specifications.

(2) SWA2

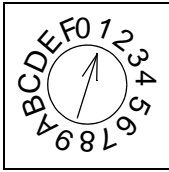
DIP switch	No.	Setting contents	Setting at shipment
	0	Standard head	1 ^[1]
	1	ESQ-C	
	2 to F	Not used	

[1] Always set to "1".

(3) SWA3

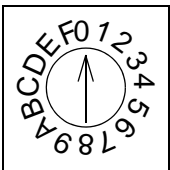
DIP switch	No.	Setting contents	
	0	Control head (Card ID)	1st H to 4th H
	1		5th H to 8th H
	2		9th H to 12nd H
	3		13th H to 16th H
	4		17th H to 20th H
	5		21st H to 24th H
	6		25th H to 28th H
	7		29th H to 30th H
	8 to F		Not used

(4) SWA4

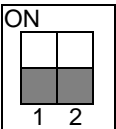
DIP switch	No.	Setting contents	OFF	ON	Setting at shipment
	1	Unable to use	—	—	OFF ^[1]
	2	Unable to use	—	—	OFF ^[1]

[1] Always set to "OFF".

(5) SWA5

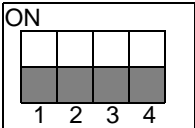
DIP switch	No.	Setting contents	OFF	ON	Setting at shipment
	1	Not used	—	—	OFF ^[1]
	2	Not used	—	—	OFF ^[1]
	3	Not used	—	—	OFF ^[1]
	4	Not used	—	—	OFF ^[1]

[1] Always set to "OFF".

[Head 13*-C card]

(1) SWC1

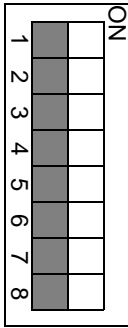
DIP switch	No.	Setting contents	OFF	ON	Setting at shipment
	1	Not used	—	—	OFF ^[1]
	2	Not used	—	—	OFF ^[1]
	3	Not used	—	—	OFF ^[1]
	4	Not used	—	—	OFF ^[1]
	5	Not used	—	—	OFF ^[1]
	6	Not used	—	—	OFF ^[1]
	7	Not used	—	—	OFF ^[1]
	8	Not used	—	—	OFF ^[1]

[1] Always set to "OFF".

4. Terminology

The following terms apply to all common models. There might be a case where it does not correspond.

<p><A></p> <p>Absolute origin An anchor point to calculate the current frame position (X: 0.0, Y: 0.0).</p> <p>ATH Abbreviation of Automatic Thread Trimming and Holding Device.</p> <p>Auto Jump To make a stitch divided into two stitches as less than setting value automatically when its stitch length exceeds the setting value. It is effective to prevent the slippage of the frame and the displacement of the design.</p> <p></p> <p>Backlash A play (gap) generated at the drive system and/or around the frame by shock when a stitch returns (when frame drive is reversed). It may affect embroidery finish.</p> <p><C></p> <p>Cleanup To remove minute stitch included in design data to make before and after stitches absorb it. It is effective to reduce thread breakage.</p> <p>Condition data (CTO) Operating condition of the machine included in the design data (Needle bar selection, data conversion, repeat, start position, automatic offset).</p> <p>CT0 File including information of needle bar selection and start position. It is necessary to handle TBF, CT0 and DGF as a set on a personal computer.</p>	<p><D></p> <p>Data mode Saving format of design data (T, T2, T3).</p> <p>Data set To set the design data in the memory of the machine to start the machine.</p> <p>D-axis Driving shaft to rotate sewing needle or nipple (TCMX series).</p> <p>DGF File that indicates design image. It is necessary to handle TBF, CT0 and DGF as a set on a personal computer.</p> <p>DST Stitch data of Tajima ternary format. Data saving format is T.</p> <p>Driver Control card to make the frame or main shaft drive. X-axis driver, Y-axis driver, main shaft driver etc. are included.</p> <p><E></p> <p>Excitation To keep frame motor drive. It is not possible to move the frame by hand during excitation.</p> <p><F></p> <p>Fixed pitch movement Horizontal frame travel to the neighboring head by head interval.</p> <p>Fixed position Main shaft angle at which the main shaft motor stops (stop position).</p> <p>Frame Back To move the embroidery frame only to the direction where the stitches return with the needle bar(s) stopped.</p>
--	---

<p>Function Code Command code that controls general movements of the machine. All design data consists of function codes (Stitch, Jump, Color, etc.).</p> <p>Frame coordinates Frame position in embroidery space. It is indicated such as "X: -153.2, Y: +120.4".</p> <p>Frame Forward To move the embroidery frame only to the direction where the stitches advance with the needle bar(s) stopped.</p> <p>Frame Limit Limit position that the frame can move (it is indicated by mark-off line on the table).</p> <p>Frame origin An anchor point to calculate the current frame position (X: 0.0, Y: 0.0).</p> <p>Frame stepping To move the embroidery frame only with the main shaft of the machine is stopped during embroidery.</p> <p><H></p> <p>Head group Function that assumes multiple heads as one head by grouping them. This enables large design embroidery or multi-colored embroidery of more colors than the number of needles per head.</p> <p><I></p> <p>Inching Movement to stabilize start of sewing by moving a needle bar slowly before the main shaft starts usual operation. It is executed before thread trimming to stabilize thread trimming.</p> <p><J></p> <p>Jump To make only the frame move in the state that needle bar does not move down during operation. It is possible to make a longer stitch than one stitch of the maximum length.</p>	<p><M></p> <p>M-axis Drive shaft to rotate nipple or bobbin (TLMX series).</p> <p>Main shaft brake To hold the main shaft with the brake of the main shaft motor so that the main shaft does not rotate when it stops.</p> <p>Minute stitch Tiny stitch as a factor causing thread breakage. Stitch of which stitch length is 0.5 mm or less.</p> <p><O></p> <p>Offset start position (Offset position) A frame travel start position set by operation of automatic offset. A position to make the machine stand by to facilitate changing of frame and/or fabric by moving the frame to the front automatically in the middle or at the end of embroidering.</p> <p><P></p> <p>Parameter Setting item that decides the working condition of the machine.</p> <p>Pseudo-fixed position (stop at the lower dead point) To stop the machine with the needle stuck in the cloth at the end of embroidery. Moving the frame in this condition will enable consecutive embroidery.</p> <p><R></p> <p>Return stitches Tie stitch to be executed at start of sewing (stitch to prevent mis-stitching at the start).</p> <p>Running stitch Decorative stitch of straight line or curved line only.</p> <p>Satin Stitch</p> <p><S></p> <p>Satin Stitch Repeated zigzag stitches. It is mainly used for hem of applique, logo, mark, flower design etc.</p>
---	--

Sequin needle

Needle that embroider with sequins by sequin device. It indicates the first needle or the last needle.

Sidekick

Name of the network application software manufactured by Pulse Microsystems Ltd. It is possible to input the design data to the machine by wireless LAN as the main function.

Step

The section divided by a color change code in the design data. The first section is called step 1, and the next section is called step 2.

<T>**Table offset**

To move the frame to the rear direction temporarily to facilitate threading. It is mainly effective when the frame is positioned at the table cut section.

Tatami stitch

Stitch to fill in a certain amount of area. It is mainly used for a big logo, background, underlay etc.

Tie stitches

Tie stitch to be executed before thread trimming (stitch to prevent fray).

TBF

Stitch data of Tajima binary format. Data saving format is T2. It can hold many more function codes compared to DST. It is necessary to handle TBF, CT0 and DGF as a set on a personal computer.

TCF

Data integrating TBF, CT0 and DGF. Integration facilitates handling of design data. Data saving format is T3.

<X>**X-axis drive system**

Drive system to make the embroidery frame move in the horizontal (X) direction.

X data

Data to make the embroidery frame move in the horizontal (X) direction. It is indicated by moving direction (code: +/-) and value (mm).

<Y>**Y-axis drive system**

Drive system to make the embroidery frame move in the vertical (Y) direction.

Y data

Data to make the embroidery frame move in the vertical (Y) direction. It is indicated by moving.

<Z>**Z-axis**

Driving shaft to change needle height (TCMX series).

A	
Absolute origin search	69
Air Pressure Sensor	172
ATH	168
Auto Color Change (AC)	143
Auto color change offset	103
Auto F.B. after T. detection	147
Auto jump	146
Auto lifting - Sequin device	161
Auto lubrication system	172
Auto origin return	154
Auto Start (AS)	143
Auto Start after auto data set	144
Auto start at same color	144
Automatic free setting offset	101
Automatic Offset	98
Automatic offset deletion	100
B	
Backlash (X)	165
Backlash (Y)	165
Boring device	171
Boring step	162
C	
Clutch lever	17
D	
Data conversion	104
Design selection screen	28
Detailed Network information	162
Dip switch setting	247
F	
F.B./F.F. Stitch unit	147
Frame back	60
Frame start timing	168
Frame Stepping Method	167
Frame Travel Speed	167
Frame travel to optional position	65
Frame type	144
H	
Halt before F.B./inching	148
Head group	124
I	
Inching after ATH	145
Input value for Frame Travel	67
Insertion of jump at sequin	171
J	
Jump Convert	146
L	
Language	155
LED lamp	172
Low speed r.p.m. / Low speed code r.p.m.	164
Lubrication cycle	158
Lubrication cycle (Head)	158
M	
Machine log data Download	73
Main screen	26
Manual Offset	65
Marking	125
N	
Needle Bar Color	157
Network	173
O	
Offset return	66
Operation panel	18
Optional position	157
Overlap Frame Back	148
P	
Power resume	70
Preset halt (1st before end code)	156
Preset Halt by Data	155
Preset Halt by Designs	156
Preset Halt by Lubrication	156
Preset Halt by stitches	155

R	
R.P.M. limit by needle position	148
Repeat	108
Return Frame at Lower dead point	170
Return the frame after manual frame travel	154
S	
Satin Stitch (area)	166
Satin Stitch (density)	166
Satin Stitch (Expansion)	166
Sequin	159
Sequin device (L)	171
Sequin device (R)	170
Sequin feed amount (L)	160
Sequin feed amount (R)	159
Sewing start return stitch	150
Start inching	145
Start position return	66
Step ratio	153
Stop at Lower Dead Point	170
T	
Table	16
Table offset switch	16
Terminology	254
Thread trim length	149
Tie stitches	151
To change color	64
To change design name	82
To change saving place of design	81
To delete a stitch	87
To delete small stitch	89
To delete the needle bar selection setting	113
To embroider design by changing condition only for the desired step	114
To insert a new setting in the needle bar selection setting	114
To insert a stitch	85
To lower needle bar	71
To lower needle bar to lower dead point	72
To modify a stitch	88
To raise needle bar	71
To set pattern No. in every needle bar step	119
To set working head for each pattern	120
To trim thread	63
To write design into a USB memory	79
Total Stitch Counter	145
Tracing	53
U	
Under thread detection	153
Upgrading of software	235
Upper thread detection	152
Upper thread lock timing	152
USB memory screen	29
USB port	18

1st Edition May, 2018

2nd Edition May, 2019

■ **Manufactured by: TISM Co.,Ltd.**

NO.1800, Ushiyama-cho, Kasugai, Aichi-pref., 486-0901, Japan
Telephone: 81-568-33-1161 Fax: 81-568-33-1191

■ **Distributed by: Tajima Industries Ltd.**

19-22, Shirakabe, 3-chome, Higashi-ku, Nagoya, 461-0011, Japan
Telephone: 81-52-932-3444 Fax: 81-52-932-2457

Copy, reprint, or modification of all or any part of this manual without permission is prohibited.

THE TAJIMA GROUP

<http://www.tajima.com>

Tajima Industries Ltd.

19-22, Shirakabe, 3-chome, Higashi-ku, Nagoya, 461-0011, JAPAN
TEL.81-52-932-3444 FAX.81-52-932-2457

TISM Co.,Ltd.

NO.1800, Ushiyama-cho, Kasugai, Aichi-pref., 486-0901, JAPAN
TEL.81-568-33-1161 FAX.81-568-33-1191