

# 7300 Series Parts List

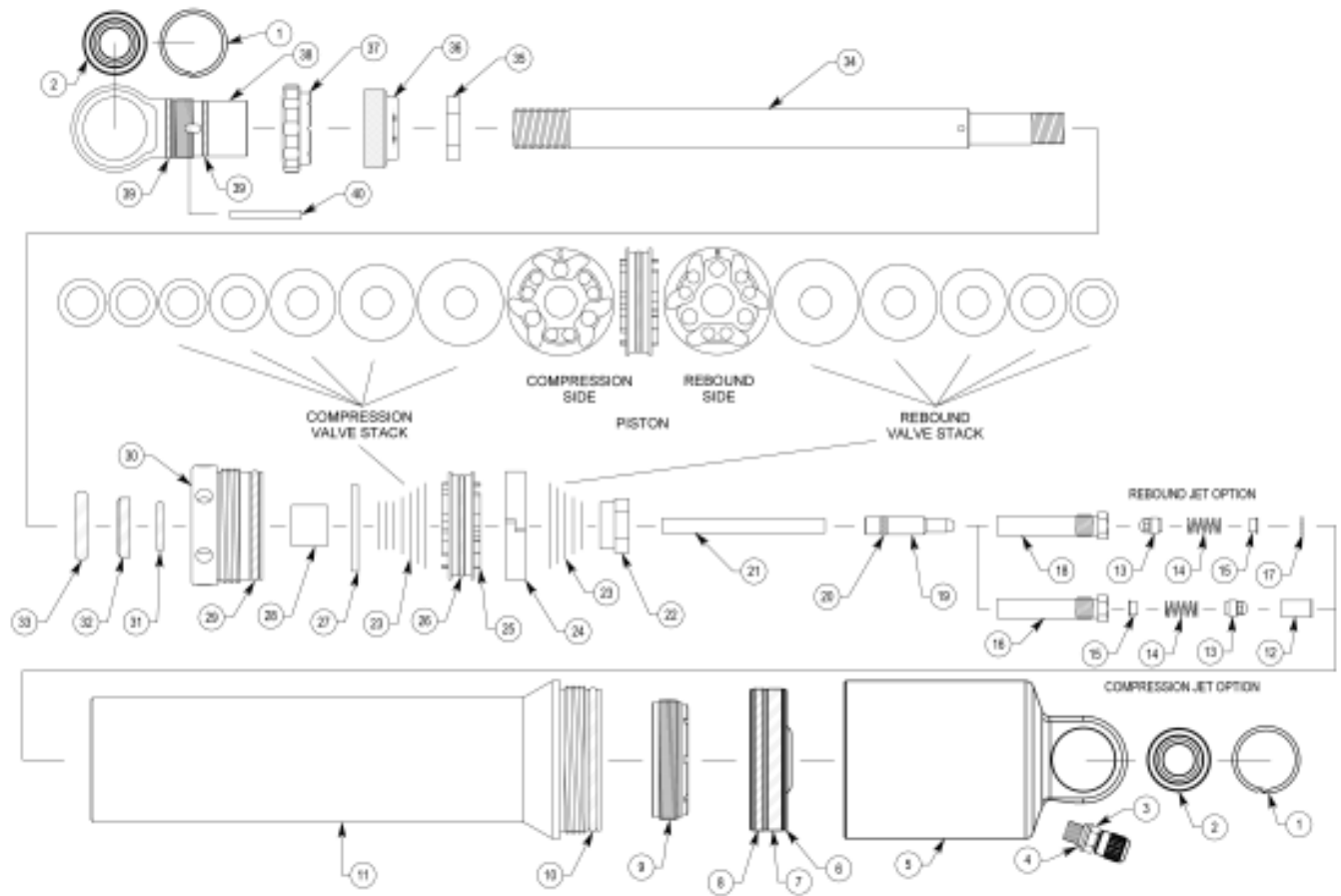

ITEM NO.	PART NO.	DESCRIPTION
1	RR-16	Retaining Ring, 1.025 Spiroloc, Stainless
2	MO-8T	Monoball, .500 ID X 1.00 OD
	MO-15T	Monoball, 15mm ID, Teflon
	<b>AS-73BA</b>	<b>Assembly, 7300 Body Complete (No Monoball) (Includes Items 3-11)</b>
3	IU-22-S	Air Valve, Port O-Ring, S.S.
	IU-04	Valve Core, 2000 psi
	IU-06	Valve Cap, High Temperature
4	OR-2010-B	O-Ring, 2-010, Buna 70
5	BC-73	Body Cap, 7300
6	PI-73LFBV	Piston, 7300 Floating Base Valve
7	PB-WCFP	Piston Band, WC Floating Piston
8	OR-4226-B	Quad Ring, 4-226, Buna 70
9	OR-2137-B	O-Ring, 2-137, Buna 70
10	SC-73INS	Screw, 7300, Body Insert
11	BD-73	Body, 7300, 9.500"
	BD-739	Body, 7300, 10.500"
	BD-737	Body, 7300, 8.500"
12	JT-76SL	Jet, Compression Spring Sleeve
13	JT-76POP	Jet, Poppet
14	SP-15	Spring, (FF71)
15	JT-76HAT	Jet, Top Hat
16	JT-CDHSNG	Jet, Compression Housing
17	RR-05	Retaining Ring, .250 Internal
18	JT-RDHSNG	Jet, Rebound or Straight Thru
19	NE-76	Needle

ITEM NO.	PART NO.	DESCRIPTION
20	OR-2007	O-Ring, 2-007, Buna 70
21	MR-7318	Metering Rod, (7" = 7.775, 8" = 8.775, 9" = 9.775)
22	NT-02R	Ring Nut, .500 x 20
23	VS-___*	Valve Stack
24	PB-55	Piston Band, 55mm
25	PI-___*	Piston
26	OR-2028-B	O-Ring, 2-028, Buna 70
27	VW-99	Top Out Plate, 1.375 x .500
	<b>AS-76SB</b>	<b>Assembly, Shaft Bearing Complete (Includes Items 27-31)</b>
28	BU-10DU10	Bushing, DU .625 x .625
29	OR-2221-B	O-Ring, 2-221, Buna 70
30	SB-765	Shaft Bearing, 8760, 55mm
31	OR-2114-V	O-Ring, 2-114, Viton 75
32	SL-09	Shaft Wiper, .625 Poly (Blue)
33	OR-2312-B	O-Ring, 2-312, Buna 70
34	SH-___*	Shaft, Adjustable, (6", 7", 8", or 9")
35	NT-04J	Jam Nut, .625 x 18
	<b>AS-WCEYELET</b>	<b>Assembly, Eyelet Complete (Includes Items 35-39)</b>
36	CP-76RD	Cap, Rebound Adjuster
37	KN-76RD	Knob, Rebound Adjuster
38	EY-73KB	Eyelet, Non Adjustable
39	OR-2017-B	O-Ring, 2-017 Buna 70
40	DO-09	Dowel Pin, 1/8" x 1 1/8"

\* Incomplete Part Number

# 7300 Head Valve Body Assembly

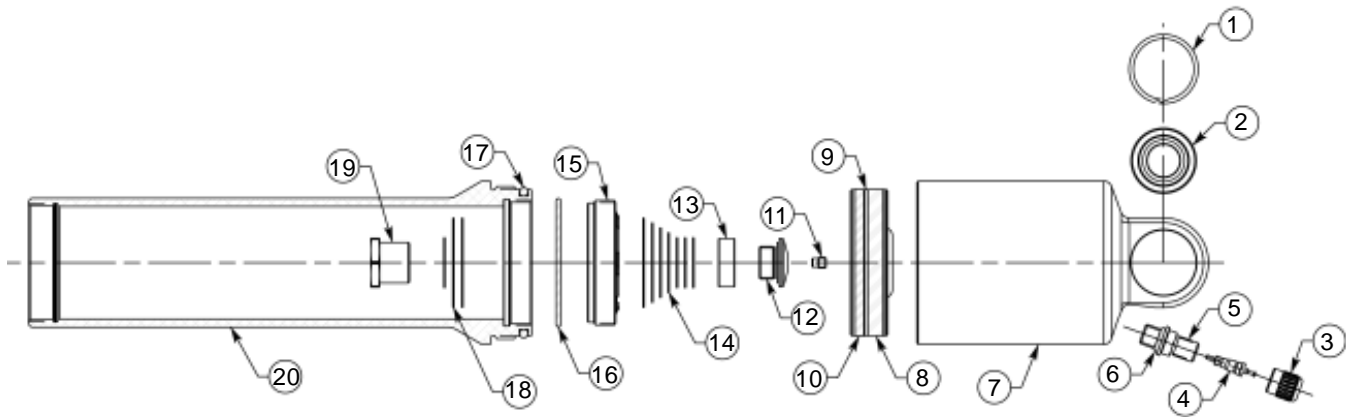

ITEM NO.	PART NO.	DESCRIPTION
	<b>AS-73HVBD9</b> <b>AS-73HVBD8</b>	<b>Assembly, 7300 Head Valve Body 9.0</b> <b>Assembly, 7300 Head Valve Body 8.0</b>
1	RR-16	Retaining Ring, 1.025 Spiroloc, Stainless
2	MO-8T	Monoball, .500 ID X 1.00 OD
3	IU-06	Valve Cap, High Temperature
4	IU-04	Valve Core, 2000 psi
5	IU-22-S	Air Valve, Port O-Ring, S.S.
6	OR-2010-B	O-ring, 2-010 Buna 70 Duro
7	BC-73	Body Cap, 7300 Series
8	PB-WCFP	Piston Band, 7300 Floating Piston
9	PI-73LFBV	Piston, 7300 Floating Base Valve

ITEM NO.	PART NO.	DESCRIPTION
10	OR-4226-B	Quad Ring, 4-226 Buna 70 Duro
11	JT-__VB*	Jet, V/B Piston (.000, .010, .015, .030, .040)
12	SC-73HV	Screw, 7300 Head Valve
13	BU-73HV	Bushing, 7300 Head Valve
14	VS-__6*	Valve Stack, .625 ID (AA - F)
15	PI-73HV-125	Piston, 7300 Head Valve, 3 X .125
16	OR-2032-B	O-ring, 2-032 Buna 70 Duro
17	OR-2137-B	O-ring, 2-137 Buna 70 Duro
18	VW-1350__-625*	Valve Washer, 1.350 X (.004 - .020) X .625
19	NT-73HV	Nut, 7300 Head Valve
20	BD-73_*	Body, 7300 (6", 7", 8", 9")

\* Incomplete Part Number

# 7300 Head Valve

Penske Racing Shocks would like to announce our new 7300 Removable Head Valve shock bodies. The new shock bodies include a female thread to accept the head valve piston or insert. These replace the one-piece head valve design and all non-head valve bodies. The new bodies come standard with an aluminum insert (P/N: SC-73INS) that maintains the piston bore the length of the body. If permitted by racing series rules, the insert may be removed, and the new removable head valve can be installed per the assembly instructions.

For reliability and safety reasons, Penske Racing Shocks requires that the new shock body design be used with either the supplied insert or the new removable head valve installed. The new shock bodies are not to be used without one of these items installed.

A removable head valve tool (P/N: TL-73INS) will be made available to all teams. This tool can be used to remove the supplied insert and install the new head valve. The assembly instructions shown below should be used when installing either the new head valve or the insert.

The new removable head valve design offers more tuning options and interchangeability than the previous design. The new bodies can be used with or without a head valve installed, allowing technicians to utilize one single body design for every application or track where two were needed previously. A shim rebound return has also been incorporated which increases rebound flow area and enhances damper response time during changes of stroke direction from compression to rebound. In addition, the new head valve assembly uses removable variable bleed jets (the same used in the Variable Bleed Pistons). The variable bleed jets can be interchanged quickly and easily (without disassembly of the head valve) and eliminates the need for drilling bleed holes in a poppet. A more tunable compression valve stack reduces the maximum base shim diameter to 1.350" for more efficient flow control and both head valve piston faces now include 1/2° of dishing.

**These new features make the removable head valve shock more user-friendly, more universal, and a proven performance enhancement for professional racing teams!**

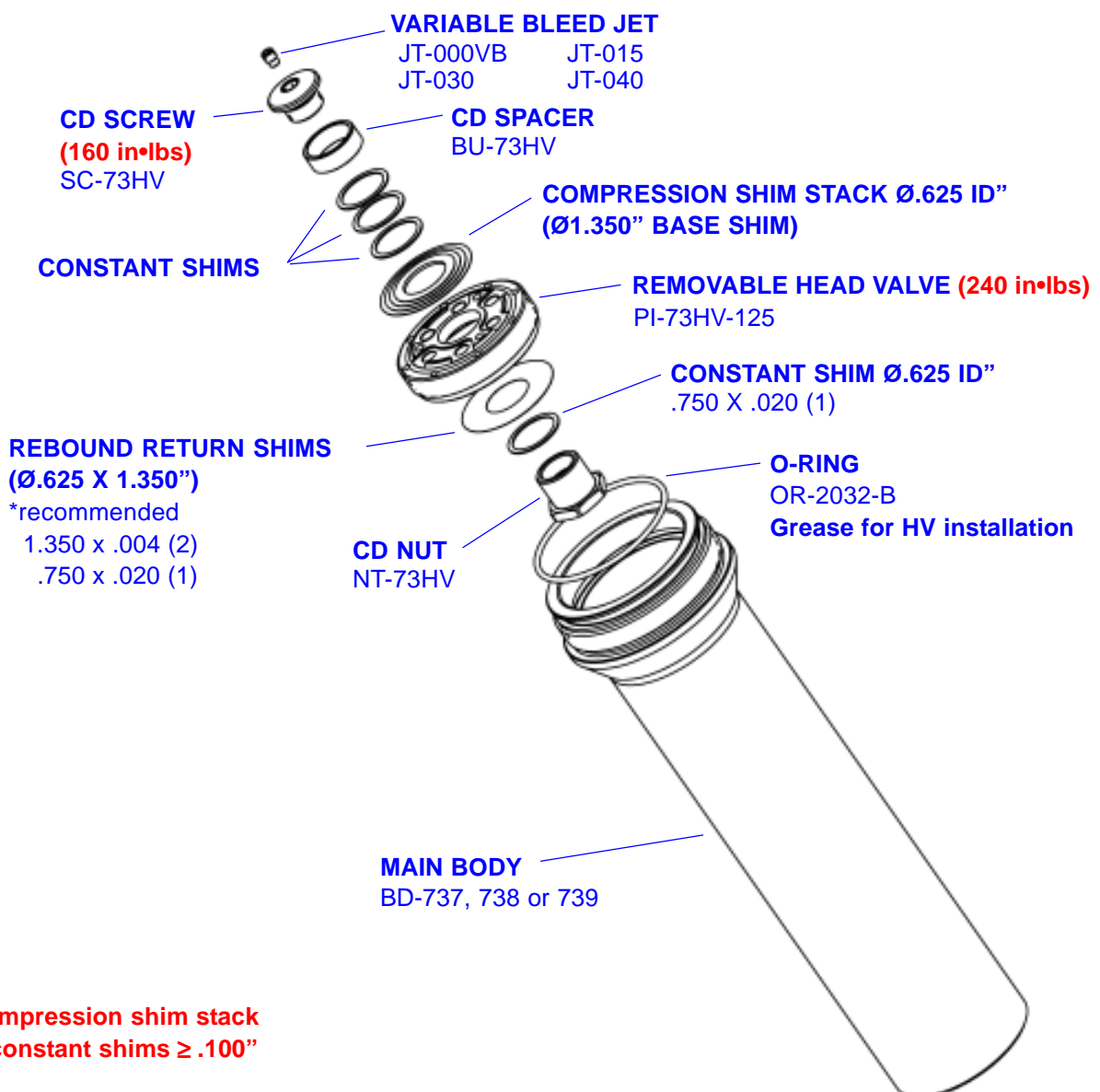

\* **Compression shim stack + constant shims ≥ .100"**

# 7300 Series Specifications

Type	Ext. Length	Stroke	Body Length
5" Coilover Body with Head Valve (Sweep Adjuster)	15.84"	4"	9.98"
6" Coilover Body with Head Valve (Sweep Adjuster)	17.84"	5"	10.98"
7" Coilover Body with Head Valve (Sweep Adjuster)	19.84"	6"	11.98"
8" Coilover Body with Head Valve (Sweep Adjuster)	21.84"	7"	12.98"
9" Coilover Body with Head Valve (Sweep Adjuster)	23.84"	8"	13.98"
7" Smooth Body Non-Head Valve (Knob Adjuster)	21.34"	7"	11.98"
8" Smooth Body Non-Head Valve (Knob Adjuster)	23.34"	8"	12.98"
9" Smooth Body Non-Head Valve (Knob Adjuster)	25.34"	9"	13.98"
7" Smooth Body with Head Valve (Knob Adjuster)	20.34"	6"	11.98"
8" Smooth Body with Head Valve (Knob Adjuster)	22.34"	7"	12.98"
9" Smooth Body with Head Valve (Knob Adjuster)	24.34"	8"	13.98"

\*Also available in Non-Adjustable

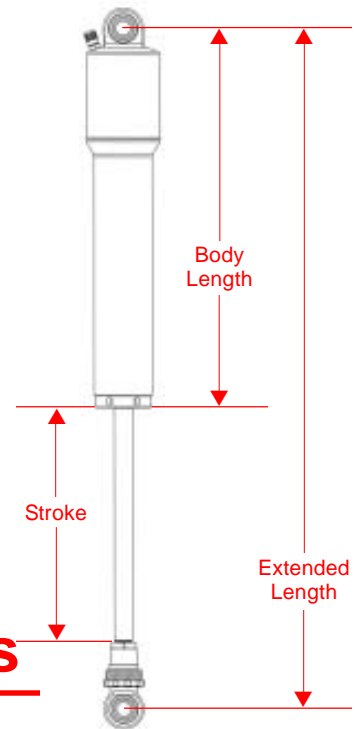

## Disassembly/Assembly Instructions

### Disassembly Instructions

1. **Depressurize** the shock after backing the adjuster to full soft.
2. Clamp the body cap eyelet in the vise with the shaft pointing up. Place overflow ring on body.
3. Unscrew the shaft bearing assembly from the shock body and remove the shaft assembly.
4. Drain the oil, when needed (if it contains excessive air bubbles). Please dispose of properly.
5. Clamp the shaft eyelet in the vise with the piston pointing up.
6. Remove the 3/4" ring nut to access valving or to change the seals in the shaft bearing.
7. Inspect and replace the damaged o-rings and wiper if needed.

### Assembly Instructions

1. For revalving, refer to page 16 for additional information.
2. Reassemble the shaft, be sure that the piston is properly positioned. With the shaft still in the vise, the compression valve stack is on the bottom and the rebound on top. It is very important that the piston is positioned with the (6) concave ports facing up on the rebound side and the (3) concave ports facing down on the compression side, see the following page.
3. Torque the 3/4" ring nut to 25 ft•lbs (300 in•lbs).
4. If the jet was removed, torque to 120 in•lbs.
5. Pressurize the reservoir to reposition floating piston (approx. 50 lbs.). **This step is very important.**
6. Fill the shock body with oil\* to the bottom of the threads. (1/2" from the top of the body)  
**\*NOTE: Penske Suspension Fluid is recommended. Use of alternate fluids may have an adverse effect on the damper's internal sealing components. (ie: o-rings)**
7. Insert the shaft and piston assembly into the shock body and begin to work out the air bubbles trapped in the piston, by using 1"-2" strokes. Move the shaft up and down a few times, making sure the two port holes in the shaft always remain below the surface of the oil or air will be sucked back into the piston assembly. Lightly tap the eyelet with a mallet a few times to assure all the air bubbles are gone.  
Note: this step is very important, repeat as needed.
8. Pull the shaft up until the two port holes in the shaft remain just below the surface of the oil.
9. Top off with oil and slide the shaft bearing down to seat the o-ring into the shock body without moving the shaft.
10. Depressurize the reservoir while asserting pressure to the shaft bearing and thread the shaft bearing into the shock body and tighten. Do not overtighten.
11. Pressurize to recommended nitrogen pressure for the specific track.

# Suggested Maintenance

---

<b>PRE RACE</b> .....	Inspect for oil leakage. Check the nitrogen pressure.
<b>EVERY 2 RACES (500 MILES)</b> .....	Change oil. Replace the shaft seal o-ring, wiper, shaft bearing o-ring, and piston o-ring.
<b>YEARLY</b> .....	Replace the reservoir cap o-ring and floating piston quad ring.

# Trouble Shooting

---

<b>LOSS OF NITROGEN PRESSURE</b> .....	Valve core is not tight or needs replacing, teflon seal on air valve needs replacing, reservoir cap o-ring needs replacing.
<b>OIL LEAK AROUND SHAFT</b> .....	Shaft seal o-ring or wiper needs replacing. <i>Note: minimal oil seepage is normal.</i>
<b>OIL LEAK BETWEEN SHAFT BEARING AND BODY</b> .....	Shaft bearing o-ring needs replacing or o-ring gland is damaged.
<b>SHAFT WILL NOT FULLY EXTEND</b> .....	Check for bent shaft, low nitrogen pressure, not enough oil. <i>Note: do not spray brake cleaner or solvent on the shaft wiper, it may cause it to swell and prevent proper movement.</i>
<b>NO CLICKS ON RED KNOB ADJUSTER</b> .....	No Nitrogen pressure or broken pin or not enough oil in the shock.

**\*\*DO NOT TRANSPORT CAR TO TRACK ON RACE SHOCKS. USE DESIGNATED SHOCKS, TOW SHOCKS, FOR TRANSPORTING.**

# Damping Adjusters

## 8760 Needle and Jet

The 8760 jet and needle combination have been designed to give the user a broader and more linear range of adjustment for bleed past the piston on rebound.

The 8760 jet utilizes a spring loaded poppet valve to check the flow. This gives a better seal against the flow and a quicker response time as the shaft changes direction.

This needle has a curved parabolic tip, which gives a very fine, linear adjustment in damping across the entire range provided by the jet. It can be thought of as a combination of the 10°, 5°, and 3° needles.

The 8760 needle and jet will fit any of our adjustable shafts, but they must be used together and cannot be interchanged with older style needles and jets.

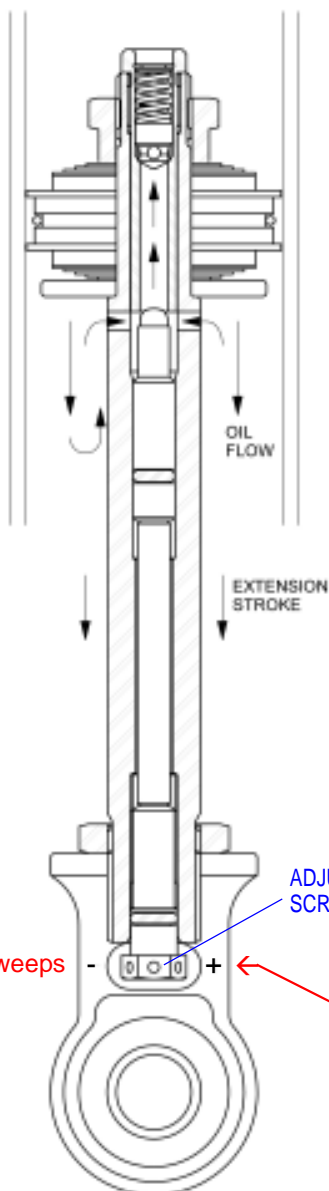
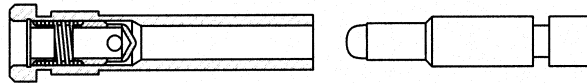

Figure 1

The 8100 style (sweep) adjuster is located in the eyelet at the base of the main shaft. Inside the window is an adjustment screw, which serves as the control point for adjustments. (Figure 1)

The 8760 adjuster (red knob) is located at the base of the eyelet (Figure 2). During the compression or rebound stage of the shock movement, fluid is forced through two ports in the main shaft. Inside the main shaft is a needle and jet assembly, which adjusts the amount of fluid passing through the jet. By turning in the adjuster (clockwise), the needle is forced up into the jet, restricting the fluid, causing firmer damping forces. In reverse, by turning the adjuster out (counter clock-wise), more oil is allowed to pass through the jet causing lighter damping forces. The adjustment assembly, is a timed control for the shims located on the main piston to work.

\*NOTE: All settings are taken from Full Hard.

i.e. -10 clicks = 10 clicks or sweeps (depending on adjuster) from Full Hard

**Available Jets:**  
 Rebound Jet  
 Compression Jet  
 Open Jet  
 Adj. .070

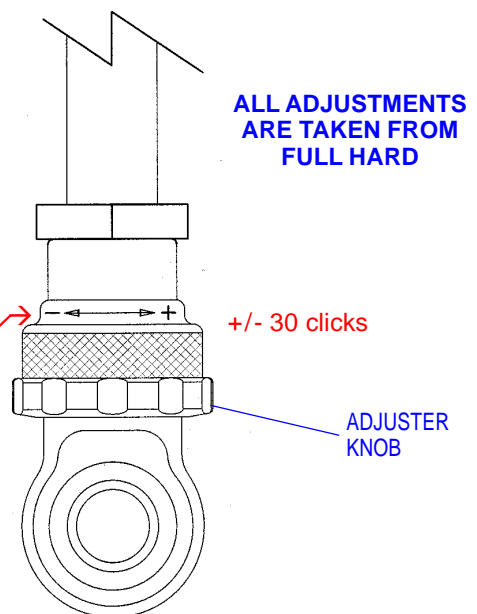
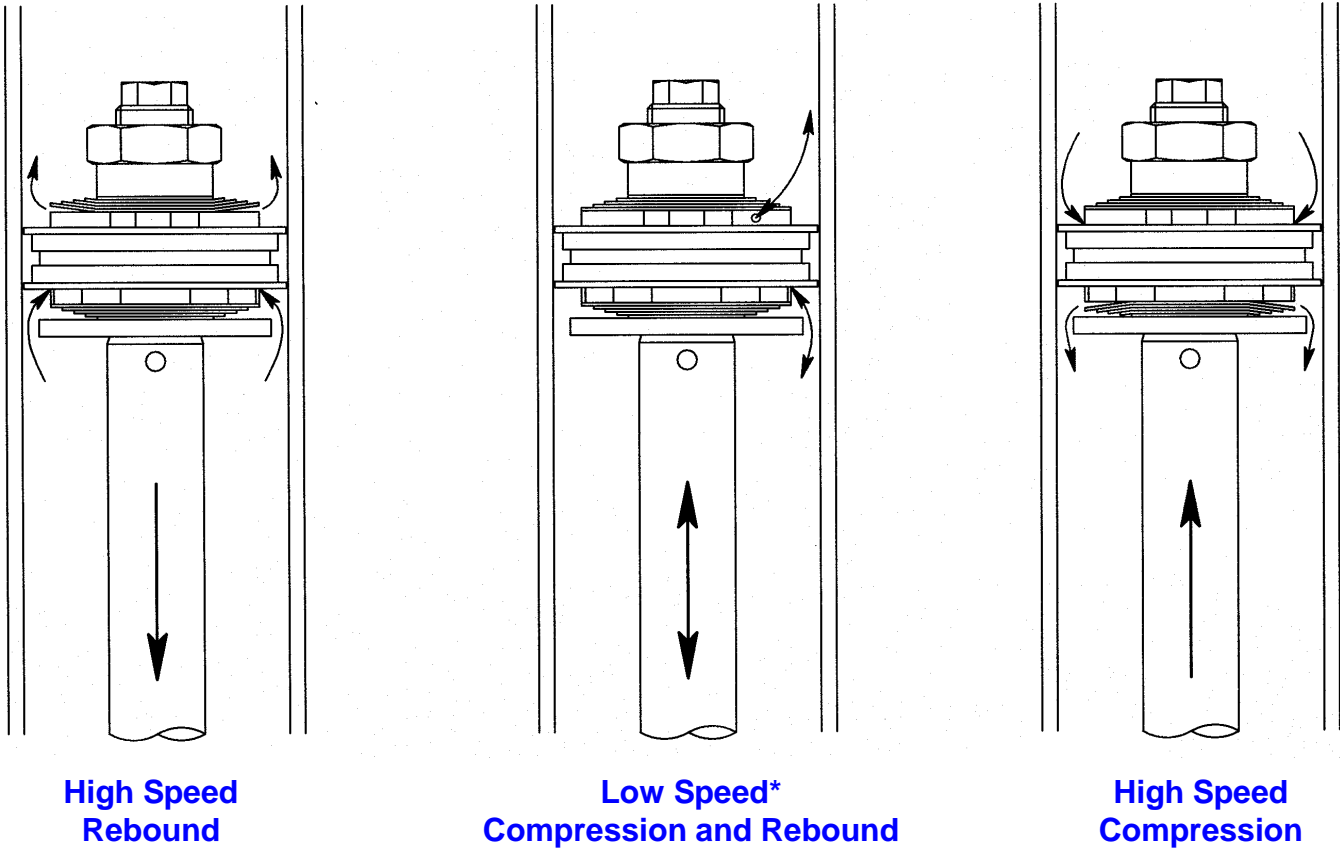

Figure 2

**+ = More Damping**  
**- = Less Damping**

The range of adjustment is affected by the stiffness of the valve stack.

# General Valving Characteristics



The damping characteristics of your shock are determined by the compression and rebound valve stacks located on the main piston.

The valve stacks are made up of a series of high quality shims, which are made to flex under the force of oil flowing through the piston ports and then return to their original state.

The thickness of the individual shims determines the amount of damping force the shock will produce. By changing the thickness of the individual shims, damping forces will be altered. For example, if you are running an "A" compression valving, where all the shims in the stack are .006 thick and you replace them with a "B" compression valving, which consists of all .008 thick shims, the compression damping will increase.

\* When the shaft is moving very slowly oil passes through the bleed hole and/or shaft bleed, if there is one, before it passes to the shims.

# A Guide To Damper Tuning

The ultimate purpose of a shock is to work together with the spring to keep the tire on the track. In compression (bump) to help control the movement of the wheel and in rebound to help absorb the stored energy of the compressed spring.

Breaking down the shaft speeds to chassis movement can be done from the data taken from on board acquisition and/or actual test sessions.

Where we find the biggest advantages with low speed adjusters is looking at the chassis in the plane of the four wheels in relation to chassis movement in roll and pitch and how quickly weight is transferred to each corner in order to load the tire sooner or later, depending on track conditions.

Usually in low grip situations allowing more bleed or less low speed damping is desirable to delay tire loading upon initial roll.

In high grip conditions adding damping or restricting bleed will load the tire sooner upon initial roll increasing platform stability.

In pitch situations on smooth surfaces under braking, increasing low speed damping or restricting bleed will help load the tires for entry or mid corner. If the tire begins bouncing under braking usually an increase in high speed compression will calm this down.

If the chassis feels like it is moving around too much between the plane of the wheels, increasing low speed damping or restricting bleed, will overall, firm up the chassis and give it a crisp feel or a better sense of feel in the car. This is why most drivers like this adjustment; as increasing low speed compression seems to give the driver better or quicker feedback from the chassis, resulting in a higher confidence in the car.

A car with too much low speed damping will usually lack grip in change of directions, cannot put power down in slower corners (wheel spin) and lack overall grip after initial turn in.

If traction is a problem coming off corners, reducing low speed damping or more bleed will help weight transfer at the rear thus increasing traction.

The range of adjustments will have a relationship to high or low shaft velocity, depending on what main piston is being used:

- 1) Linear Piston 1° - adjustment through range
- 2) Linear Piston 2° - greater change in low speed adjustment
- 3) Velocity Dependent Piston - adjustment through range with greater change in low speed
- 3) Digressive Piston - range primarily in low speed

Also depending on valving, there will be an affect on adjustment range. The softer the valving (A - B), the less force range it will have. This is due to a lower pressure required to blow the valves on the main piston. Obviously the heavier the valving (C - E), the more effective the bleed becomes. On digressive pistons, pre-load also affects the range of adjustment.

Rebound adjustments are usually indicated by the driver asking for more stability. By increasing low speed damping, stability will be enhanced; decreasing damping will allow more movement in the car, but will result in a little better tire wear.

Also, the amount of rebound can have a great influence on weight transfer. Less front rebound allows weight transfer to the rear under acceleration. Less rebound in the rear allows for a greater amount of weight transfer to the front under braking and turn in.

When a car is over damped in rebound it can pack down in a series of bumps and a driver will recognize this as too stiff and usually will think it is compression damping. Too much rebound can cause lack of grip on cornering.

When making a large spring change keep in mind where the rebound adjuster is and do you have enough range to compensate. Sometimes a spring change will bring a better balance to the damping values after the spring change. If the spring/shock combination was balanced, the rule of thumb is a stiffer spring requires lower compression and higher rebound. A softer spring requires higher compression and lower rebound.

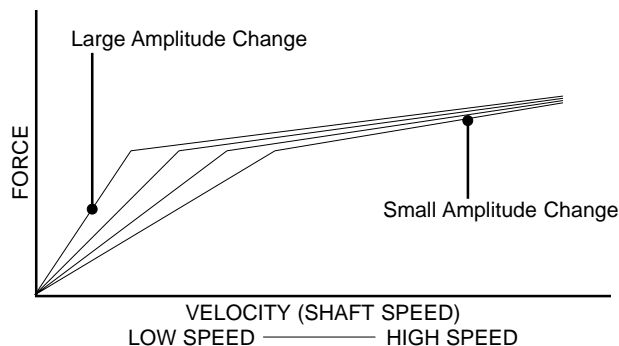

**LOW SPEED ADJUSTMENT EXAMPLE  
(BLEED)**

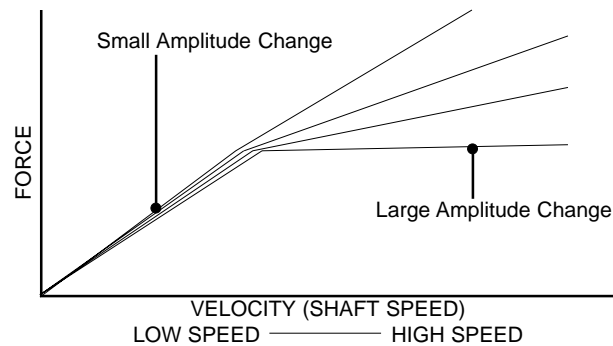

**HIGH SPEED ADJUSTMENT EXAMPLE  
(SHIM)**



# General Oval Track Tuning Tips

---

## Bump in Front Usually Effects:

1. Middle
2. Entry

## Rebound in Rear Usually Effects:

1. Middle
2. Entry

## Rebound in Front Usually Effects:

1. Middle
2. Exit

## Bump in Rear Usually Effects:

1. Middle
2. Exit

## Push Off Exit of Corners

1. Increase Rebound RF
2. Decrease Rebound LF
3. Increase Compression RR

## Loose Off Exit of Corners

1. Decrease Rebound RF
2. Decrease Compression RR
3. Increase Rebound LF

## Push in Middle of Corners

1. Decrease Rebound LF
2. Increase Compression RR
3. Increase Rebound RF
4. Decrease Compression LF

## Loose in Middle of Corners

1. Decrease Compression RR
2. Decrease Rebound RF
3. Increase Rebound LR

## Push on Entry to Corners

1. Decrease Compression  
Both Front Shocks
2. Decrease Compression RF
3. Increase Rebound LR

## Loose on Entry to Corners

1. Increase Compression  
Both Front Shocks
2. Increase Compression RF
3. Decrease Rebound LR

# Valving

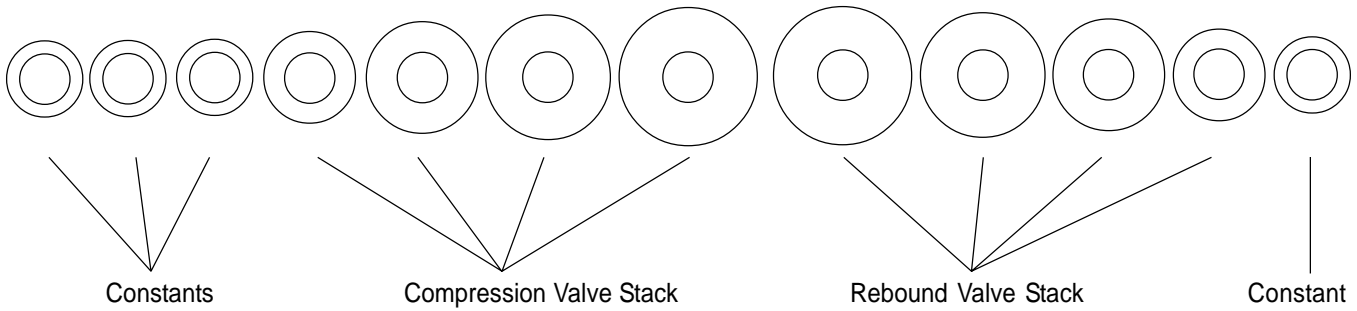

When referring to shock valving, (example: A/B), (A) refers to the compression valve stack and (B) refers to the rebound valve stack.

# Valve Stacks

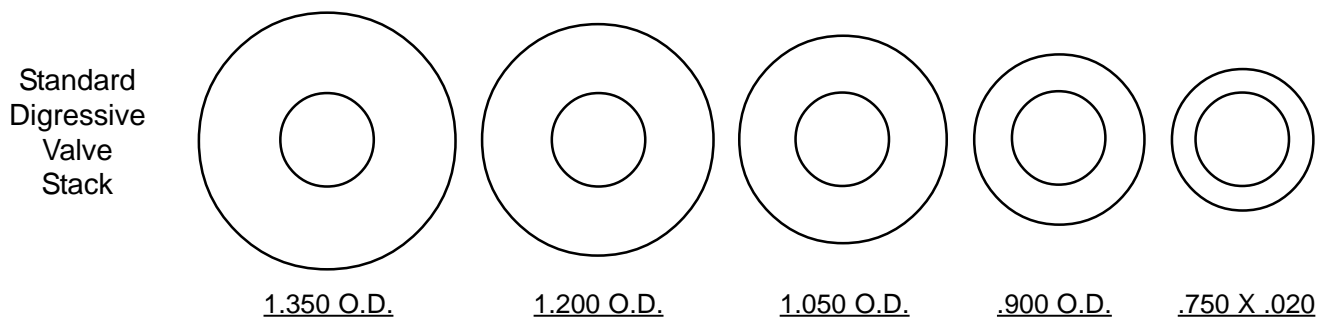

Part #		1.350 O.D.	1.200 O.D.	1.050 O.D.	.900 O.D.	.750 X .020
VS-AA	AA	.004	.004	.004	.004	Constant
VS-AAP	AA+	.004	.004	.006	.006	Constant
VS-AM	A-	.006	.006	.004	.004	Constant
VS-A	A	.006	.006	.006	.006	Constant
VS-AP	A+	.006	.006	.008	.008	Constant
VS-BM	B-	.008	.008	.006	.006	Constant
VS-B	B	.008	.008	.008	.008	Constant
VS-BP	B+	.008	.008	.010	.010	Constant
VS-CM	C-	.010	.010	.008	.008	Constant
VS-C	C	.010	.010	.010	.010	Constant
VS-CP	C+	.010	.010	.012	.012	Constant
VS-DM	D-	.012	.012	.010	.010	Constant
VS-D	D	.012	.012	.012	.012	Constant
VS-DP	D+	.012	.012	.015	.015	Constant
VS-EM	E-	.015	.015	.012	.012	Constant
VS-E	E	.015	.015	.015	.015	Constant
VS-EP	E+	.015	.015	.020	.020	Constant
VS-FM	F-	.020	.020	.015	.015	Constant
VS-F	F	.020	.020	.020	.020	Constant

1.350 O.D. and 1.200 O.D. primarily affects Low Speed  
 .900 O.D. and 1.050 O.D. primarily affects High Speed

1.475 Shim is used on specific pistons and is generally the same thickness as the 1.350 shim

# VDP and Digressive Valving Information Options

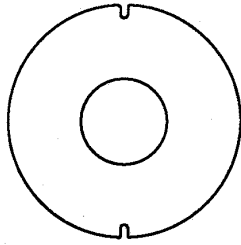

2 Notch  
1.350 O.D.

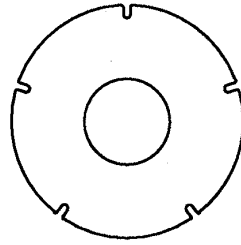

5 Notch  
1.350 O.D.

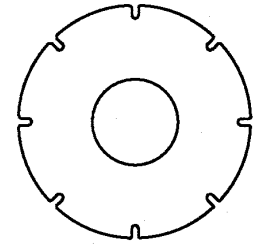

8 Notch  
1.350 O.D.

Part #	Part #	Part#
.004 VW-2NX.004	.004 VW-5NX.004	.004 VW-8NX.004
.006 VW-2NX.006	.006 VW-5NX.006	.006 VW-8NX.006
.008 VW-2NX.008	.008 VW-5NX.008	.008 VW-8NX.008

## Flow Rate Through Slotted Shims

Shim Thickness	Number of Notches	Relative Flow Rate	Equivalent Bleed Hole Ø (1) Hole
0.004	2	0.48	0.022
0.004	5	1.20	0.035
0.004	8	1.93	0.044
0.006	2	0.64	0.025
0.006	5	1.61	0.040
0.006	8	2.57	0.051
0.008	2	0.86	0.029
0.008	5	2.14	0.046
0.008	8	3.42	0.059

These flow rate values are dimensionless and have no real meaning by themselves. They are simply used to cross-reference the amount of flow between different bleed hole or slot combinations. For example, four Ø.010" holes would have the same flow rate as one Ø.020" hole (with a flow rate of 0.40). The flow rates can also be added, so a piston with three Ø.015" and three Ø.020" holes would have a total flow rate value of  $0.68 + 1.20 = 1.88$  which would be the same as three Ø.025" holes.

## VDP 55mm Linear Base Shim

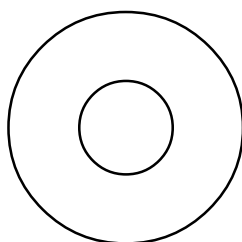

1.235 O.D.

Part #
.004 VS-37
.006 VS-39
.008 VS-41
.010 VS-43
.012 VS-45
.015 VS-47

## Preload Shim Spacers

Part#
.004 x .750 VW-23
.006 x .750 VW-25
.008 x .750 VW-27
.010 x .750 VW-29
.012 x .750 VW-31
.015 x .750 VW-33
.020 x .750 VW-00

# Flow Rate Through Multiple Bleed Holes

---

Hole Diameter	1 Hole	2 Holes	3 Holes	4 Holes	5 Holes	6 Holes	7 Holes	8 Holes	9 Holes
0.010	0.10	0.20	0.30	0.40	0.50	0.60	0.70	0.80	0.90
0.012	0.14	0.29	0.43	0.58	0.72	0.86	1.01	1.15	1.30
0.015	0.23	0.45	0.68	0.90	1.13	1.35	1.58	1.80	2.03
0.018	0.32	0.65	0.97	1.30	1.62	1.94	2.27	2.59	2.92
0.020	0.40	0.80	1.20	1.60	2.00	2.40	2.80	3.20	3.60
0.022	0.48	0.97	1.45	1.94	2.42	2.90	3.39	3.87	4.36
0.024	0.58	1.15	1.73	2.30	2.88	3.46	4.03	4.61	5.18
0.025	0.63	1.25	1.88	2.50	3.13	3.75	4.38	5.00	5.63
0.026	0.68	1.35	2.03	2.70	3.38	4.06	4.73	5.41	6.08
0.028	0.78	1.57	2.35	3.14	3.92	4.70	5.49	6.27	7.06
0.030	0.90	1.80	2.70	3.60	4.50	5.40	6.30	7.20	8.10
0.032	1.02	2.05	3.07	4.10	5.12	6.14	7.17	8.19	9.22
0.034	1.16	2.31	3.47	4.62	5.78	6.94	8.09	9.25	10.40
0.035	1.23	2.45	3.68	4.90	6.13	7.35	8.58	9.80	11.03
0.036	1.30	2.59	3.89	5.18	6.48	7.78	9.07	10.37	11.66
0.038	1.44	2.89	4.33	5.78	7.22	8.66	10.11	11.55	13.00
0.040	1.60	3.20	4.80	6.40	8.00	9.60	11.20	12.80	14.40
0.045	2.03	4.05	6.08	8.10	10.13	12.15	14.18	16.20	18.23
0.050	2.50	5.00	7.50	10.00	12.50	15.00	17.50	20.00	22.50
0.055	3.03	6.05	9.08	12.10	15.13	18.15	21.18	24.20	27.23
0.060	3.60	7.20	10.80	14.40	18.00	21.60	25.20	28.80	32.40
0.062	3.84	7.69	11.53	15.38	19.22	23.06	26.91	30.75	34.60
0.064	4.10	8.19	12.29	16.38	20.48	24.58	28.67	32.77	36.86
0.066	4.36	8.71	13.07	17.42	21.78	26.14	30.49	34.85	39.20
0.068	4.62	9.25	13.87	18.50	23.12	27.74	32.37	36.99	41.62
0.070	4.90	9.80	14.70	19.60	24.50	29.40	34.30	39.20	44.10
0.072	5.18	10.37	15.55	20.74	25.92	31.10	36.29	41.47	46.66

# Piston Selection

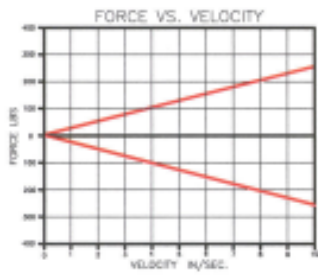

Compression Face

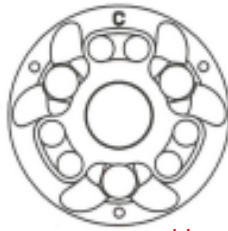

Rebound Face

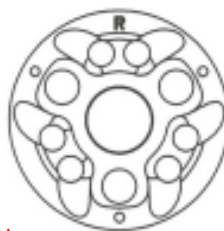

Linear/Linear

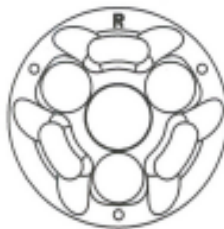
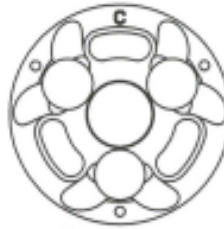
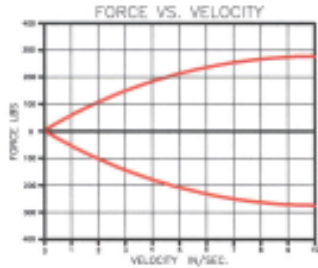

High Flow

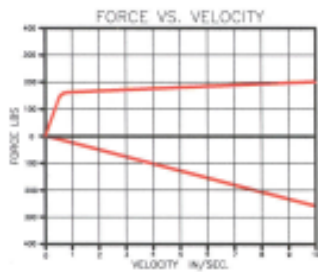

Digressive/Linear

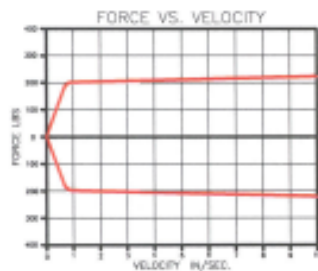

Digressive/Digressive

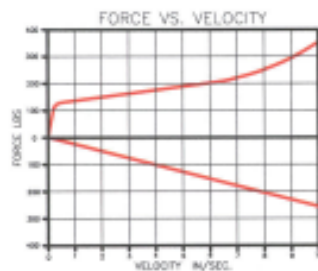

Velocity Dependent/Linear

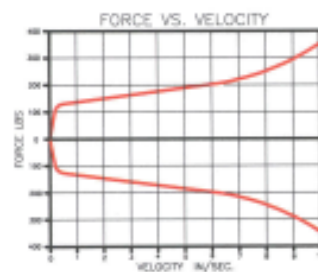

Velocity Dependent/Velocity Dependent

## Digressive Blow Off

This two stage piston combines the low shaft speed characteristics of a linear piston with the blow off characteristic of a digressive piston at higher shaft speeds. Both parts of the curve are independently tunable.

COMPRESSION

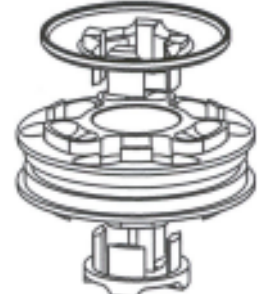

REBOUND

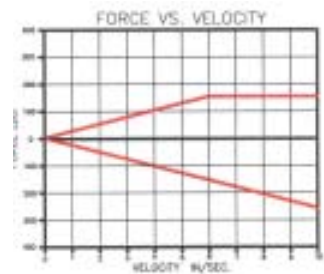

## Variable Bleed

The Variable Bleed Piston offers the user more versatility than any other piston in our range. The piston can produce curves like those found on linear, digressive and VDP pistons and offers a very flexible way of controlling bleed.

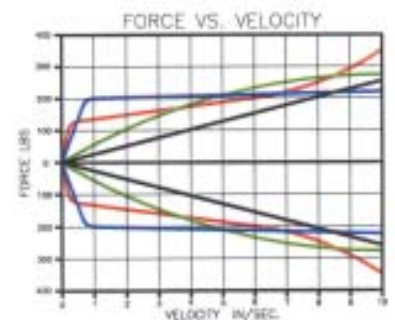
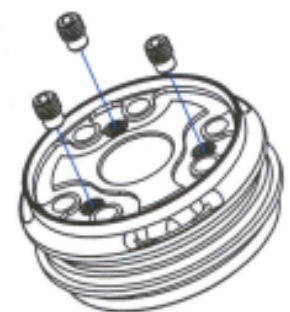

# Piston Selection

	Compression Face	Rebound Face	
			<b>Decoupled Linear/Linear</b>
			<b>Decoupled High Flow</b>
			<b>Decoupled Velocity Dependent/Linear</b>
			<b>Decoupled Velocity Dependent/Velcity Dependent</b>
			<b>Enhanced Linear Flow</b>
			<b>Flower / Moto-X</b>

PART NO.	DESCRIPTION
PI-00005-4032	Linear, 0°/0°, 4032, 55mm
PI-11004	Linear, 1°/1°, 45mm
PI-11005-4032	Linear, 1°/1°, 4032, 55mm
PI-1200_*	Linear 1°/2°, 45mm/55mm
PI-2100_*	Linear, 2°/1°, 45mm/55mm
PI-2200_*	Linear, 2°/2°, 45mm/55mm
PI-11005-4032-DC	Linear, 1°/1°, 4032, Decoupled, 55mm
PI-12005-DC	Linear, 1°/2°, DC, 55mm
PI-21005-DC	Linear, 2°/1°, DC, 55mm
PI-22005-DC	Linear, 2°/2°, DC, 55mm
PI-HF00005	HF Linear, 0°/0°, 55mm
PI-HF11005	HF Linear, 1°/1°, 55mm
PI-HF1200_*	HF Linear, 1°/2°, 45mm/55mm
PI-HF14005	HF Linear, 1°/4°, 55mm
PI-HF21005	HF Linear, 2°/1°, 55mm
PI-HF22005	HF Linear, 2°/2°, 55mm
PI-HF24005	HF Linear, 2°/4°, 55mm
PI-HF32005	HF Linear, 3°/2°, 55mm
PI-HF34005	HF Linear, 3°/4°, 55mm
PI-HF11005-DC	HF Linear, 1°/1°, Decoupled, 55mm
PI-HF12005-DC	HF Linear, 1°/2°, Decoupled, 55mm
PI-HF14005-DC	HF Linear, 1°/4°, Decoupled, 55mm
PI-HF21005-DC	HF Linear, 2°/1°, Decoupled, 55mm
PI-HF22005-DC	HF Linear, 2°/2°, Decoupled, 55mm
PI-HF24005-DC	HF Linear, 2°/4°, Decoupled, 55mm
PI-DL00_*	Digressive/Linear, 45mm/55mm
PI-DL005-1DG	Digressive/Linear, 1°, 55mm
PI-DD00_*	Double Digressive, 45mm/55mm
PI-VDL45	VDP/Linear, 45mm
PI-VDPL55	VDP/Linear, 55mm
PI-VDPL55-DC	VDP/Linear, Decoupled, 55mm
PI-VDPL55-1DEG	VDP/Linear, 1°, 55mm
PI-VDPL55-1DEG-DC	VDP/Linear, 1°, Decoupled, 55mm
PI-VDP45	Double VDP, 45mm
PI-VDP5	Double VDP, 55mm
PI-VDP5-DC	Double VDP, Decoupled, 55mm
PI-ELF55	Enhanced Linear Flow, 55mm
PI-PR11005	Flower, 55mm
PI-VB55	Variable Bleed Jet, 55mm
PI-BLOWOFF-11	Blowoff, Complete, 1°/1°, 55mm
PI-BLOWOFF-12	Blowoff, Complete, 1°/2°, 55mm
PI-BLOWOFF-21	Blowoff, Complete, 2°/1°, 55mm

\* Incomplete Part Number

# Linear Piston / High Flow

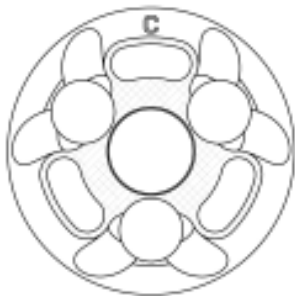
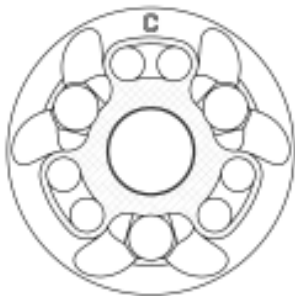

Linear Piston

High Flow Piston

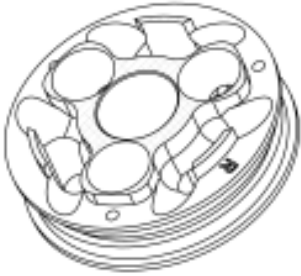

 = Shim Sealing Surface

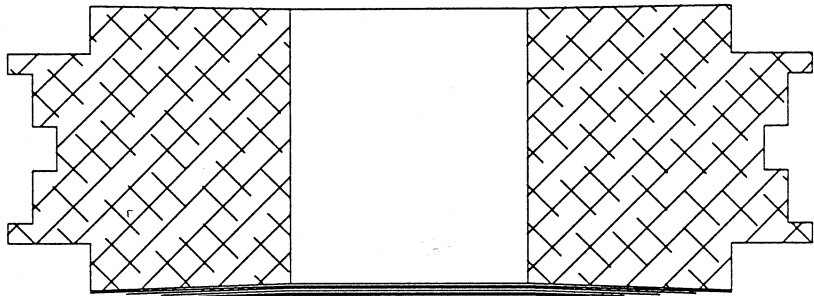

COMPRESSION VALVING  
PRELOADED WITH 2° DISH

STANDARD 1° DISH

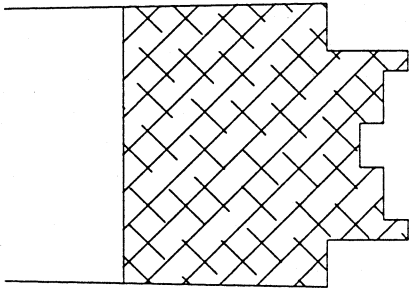
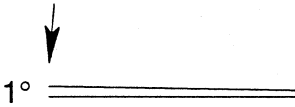

Each piston face has a dished surface, to preload the valve shims flat against the piston face. The standard dishing is 1° on both the compression and rebound sides of the piston. By increasing the compression side dishing to 2°, the shims become increasingly preloaded, causing a slight delay in opening during compression movement. The dishing causes the shims to “snap” open, in return giving the car a “snappier” feel as opposed to a smooth roll, once again this modification is for driver feel. Dishing increases low speed control. If you have questions on piston dishing, call our technical staff for information and recommendations.

# Digressive Piston

## Digressive Piston

The digressive design incorporates larger ports on the face of the piston to increase the flow of oil throughout the shocks high speed action. When the shim stack opens, oil is “dumped” through the piston in large capacities. The increased flow of oil reduces the progressive damping characteristics of the linear side of the piston.

In addition to the larger ports, the face of the piston is designed to allow adjustments to the preload on the shim stack. Increased preload delays the opening of the shim stack, causing an increased damping force at low shaft speeds. When the shims crack open, oil is “dumped” at a high rate, reducing the progressive damping characteristics.

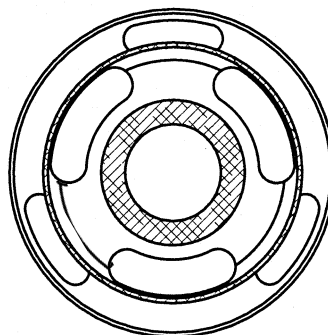

Digressive Face

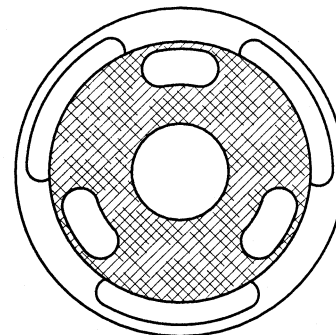

Linear Face

To visually explain piston preload, Figure 3, shows a digressive/linear piston with zero preload on the shim stack. Figure 4, shows a digressive/linear piston with an exaggerated amount of preload. The preload cups the shim stack, energizing the shims until the instant high shaft velocity snaps them open. The preload may be varied by adding or subtracting a series of shims under the main shim stack.

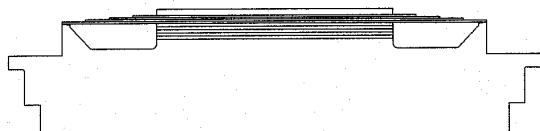

FIGURE 3  
NON-PRELOADED  
SHIM STACK

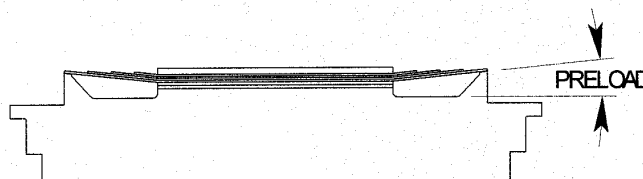
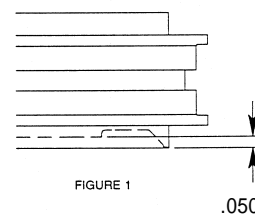
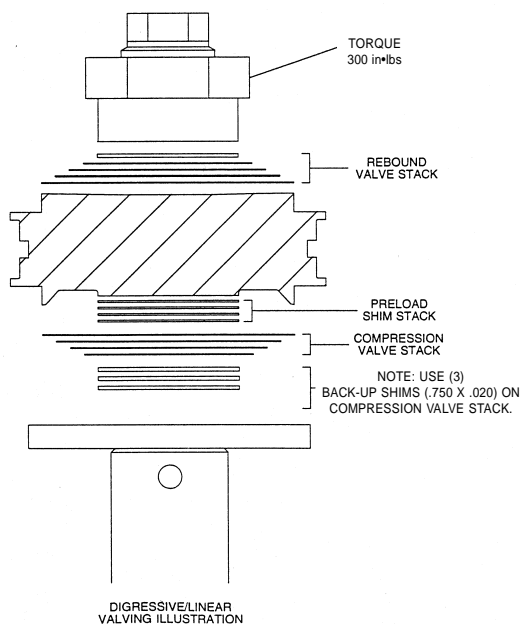

FIGURE 4  
PRELOADED  
SHIM STACK

The digressive piston design is offered in two variations. The double digressive piston is preload variable on both the compression and rebound sides. The digressive / linear piston is preload variable on the digressive side only, leaving the other side with linear characteristics. In most cases, the linear side of the piston would be rebound, however, it can be used either way.

## Digressive/Digressive

The double digressive piston has .050 of available preload as shown in Figure 1. Stacking preload shims between the piston and the shim stack varies the amount of preload on the shim stack. When referring to the amount of preload on a shim stack, you're referring to the amount of preload on the piston face of the shim stack. For example; .010 preload = .050 (total available preload) minus .040 (the combined thickness of the preload stack).



## Digressive/Linear

The linear side of the digressive/linear piston is treated as a standard linear piston. Due to the higher flow when running the linear side on rebound, it is a rule of thumb to run (1) step stiffer on the rebound side than what was used on a standard linear piston (example: A up to B).



# Velocity Dependent Piston (VDP)

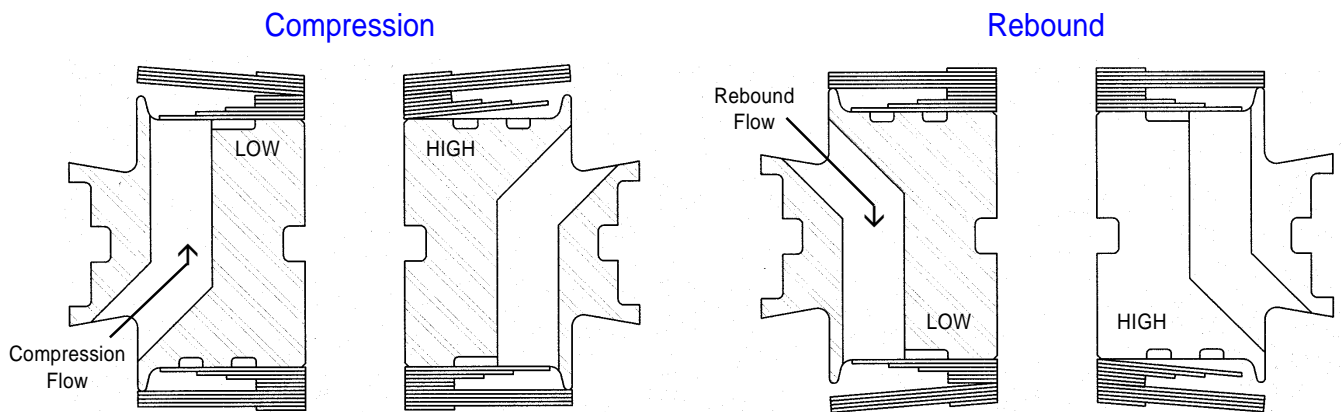
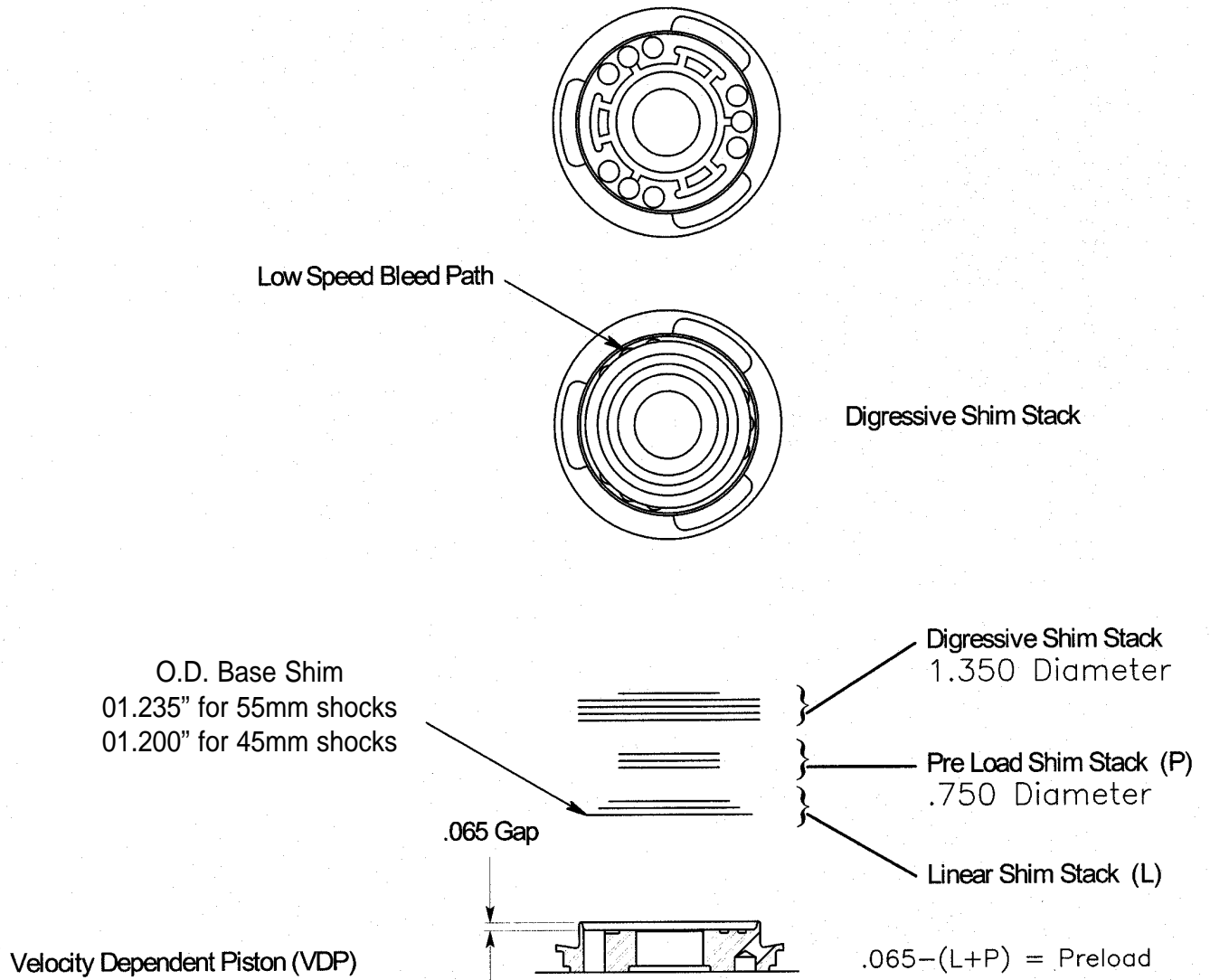

This graph illustrates the way in which the two different circuits operate on compression.

This graph illustrates the way in which the two different circuits operate on rebound side.

Low speed works the digressive stack and high speed works both.

# Velocity Dependent Piston (VDP)

The Velocity Dependent Piston (VDP) has the unique ability to be valved to duplicate the curves of either linear or digressive pistons. Varying the inner, outer and preload stacks in conjunction with various bleed combinations can duplicate virtually any type of force value. Also the velocity where forces come in or out can be varied by altering the shims and preload/bleed combinations.

Note: On the VDP we have found that using all 1.350 shims for the digressive outer stack (primarily on compression) helps to separate the high and low speed circuits in the piston resulting in more compliance over bumps

and curbs. When running the linear side on rebound, it is a rule of thumb to run (1) step stiffer on the linear side than what was used on a standard linear piston.

1. The Low Speed section is controlled by the amount of bleed, the outer valve stack configuration and the amount of preload to determine the nose profile.
2. The Digressive profile is set by the thickness of the outer stack. The amount of time that the curve stays digressive is also influenced by the stiffness of the inner stack and when it is initiated is also controlled by the preload.
3. The Linear values and profile are set by the thickness of the inner stack.
4. The values and time of the progressive profile are determined by the orifice holes and the inner stack.

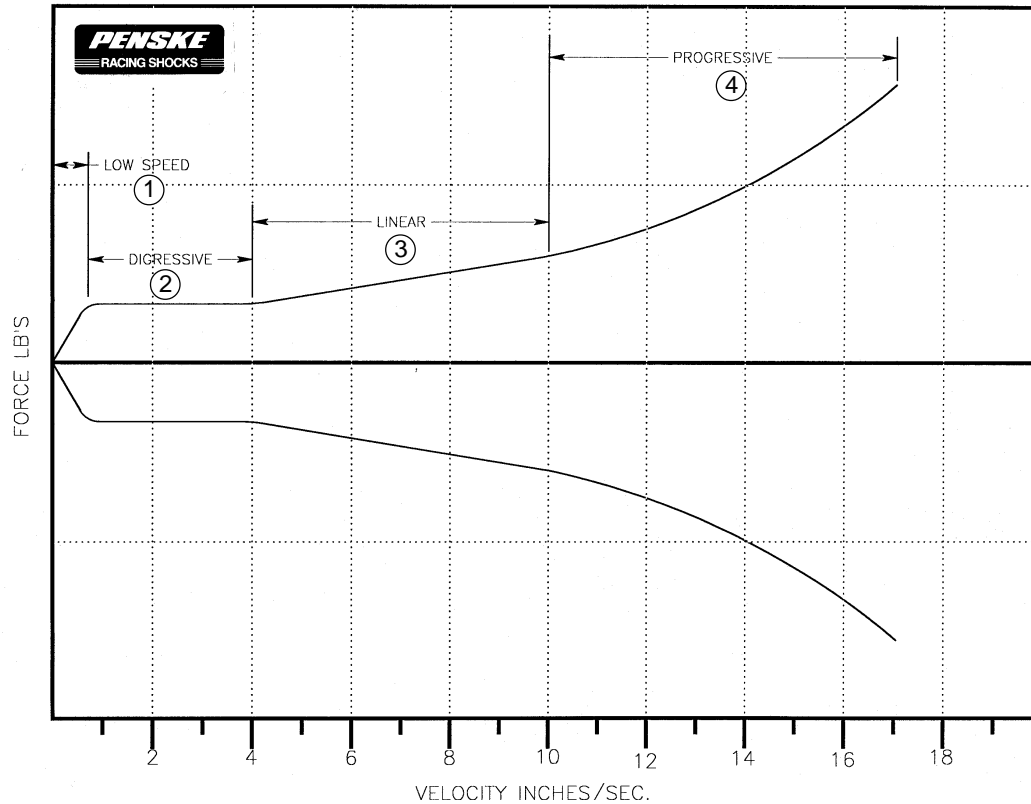

1. Low Speed - Bleed, Nose Profile

3. Linear - Inner Stack

2. Digressive - Preload, Outer Stack

4. Progressive - Orifice, Inner Stack

# Damping Adjustments

There are three major ways in which you can vary the damping produced by the main piston: Shim stiffness, shim pre-load and the amount of bleed past the shims. These graphs help to visualize the way in which the damping is affected by each of these changes.

**Figure 1** shows the effect of changing the pre-load (on digressive or VDP pistons) or dish (on linear or high flow pistons). Adding pre-load or dish will create a lot more low speed damping. In compression, it will cause the tire to be loaded quicker and give a “snappy” feel. In rebound, it will help to tie the vehicle down and let it take a set quicker.

**Figure 2** shows the effect of increasing the stiffness of the shim stack. Increasing the thickness of the shim stack (i.e., .004 to .010) stiffens the damping rate of the shock across the whole velocity range. While the other two adjustments only affect the lower shaft speeds, the shim stiffness is the best way to adjust damping at higher shaft speeds. The shims give the damping that chassis dynamics require.

**Figure 3** shows the effect of adding bleed to the piston or through the shaft. Bleed is simply a low speed bypass for the shims and softens the shock at lower shaft speeds. This will improve the compliance of the chassis to the ground under low amplitude movements which can improve grip. It will give the driver a softer ride, but will let the chassis move more and take away support. (This is what the driver feels)

Figure 1

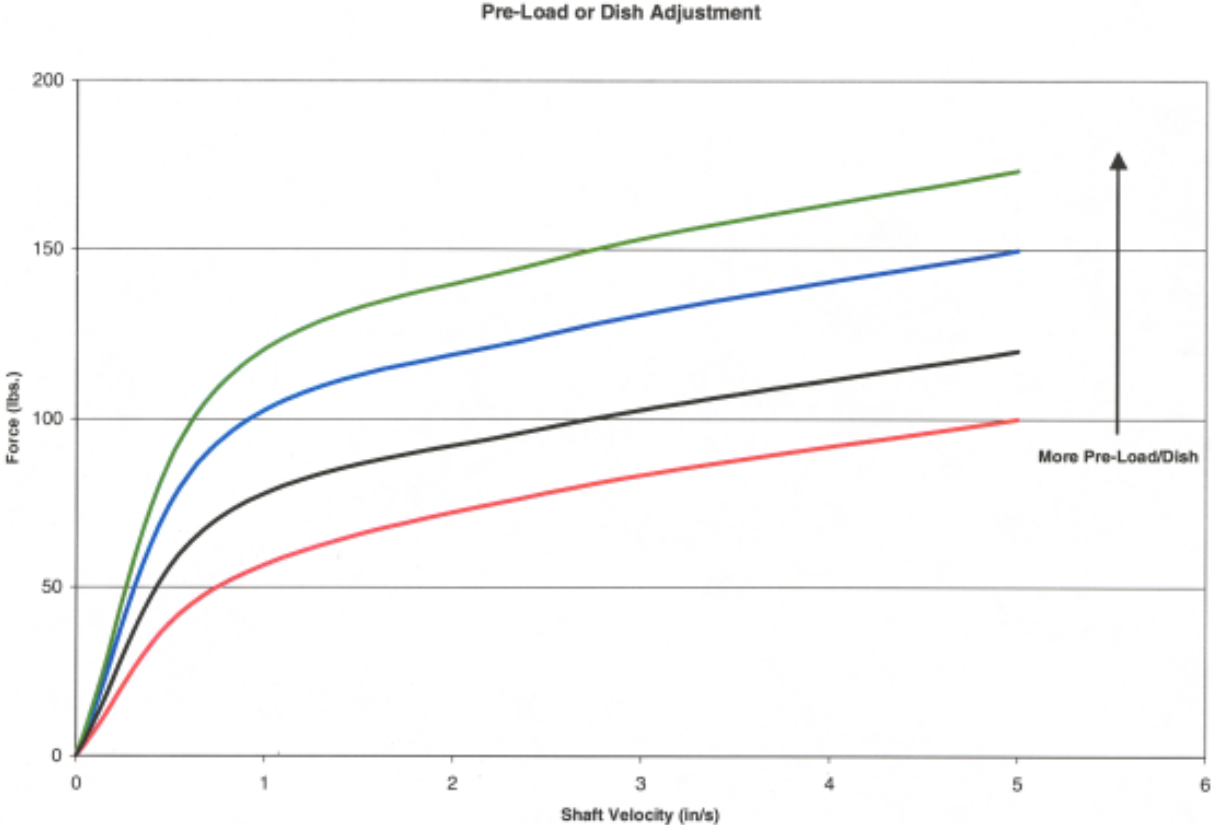

# Damping Adjustments

Figure 2

Shim Adjustment

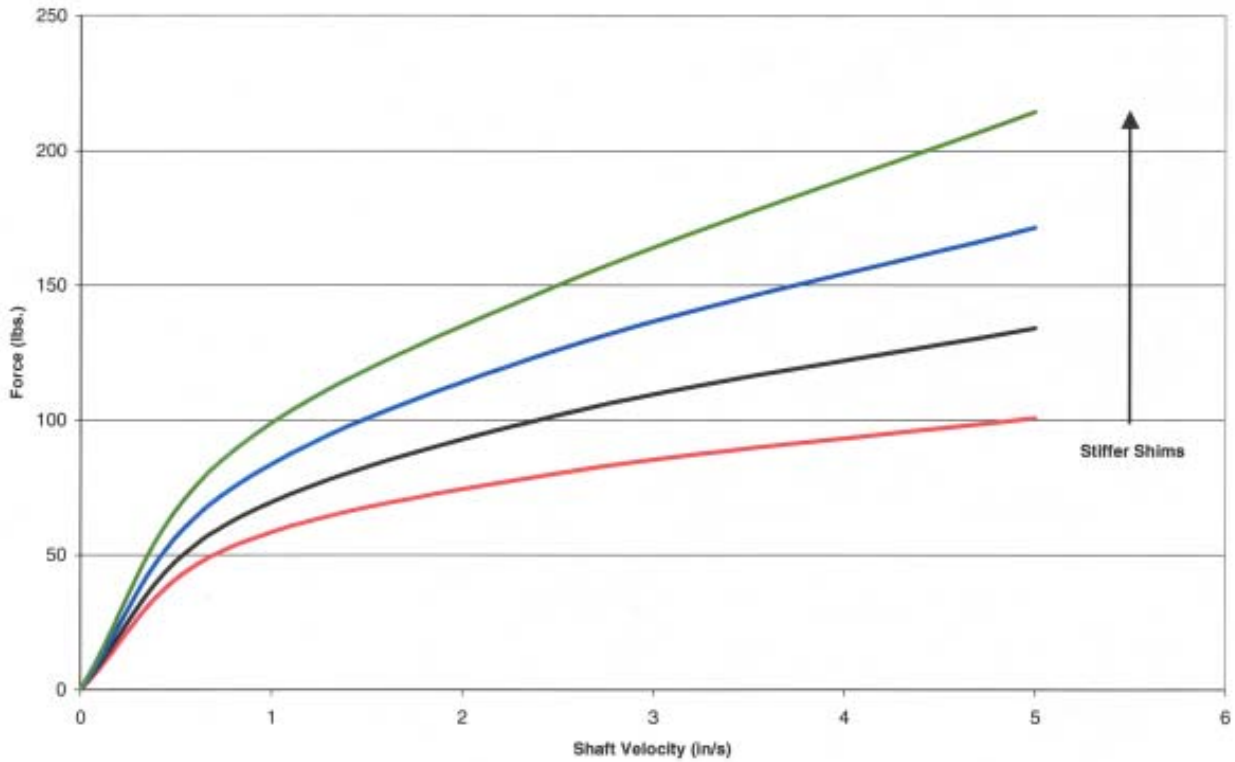
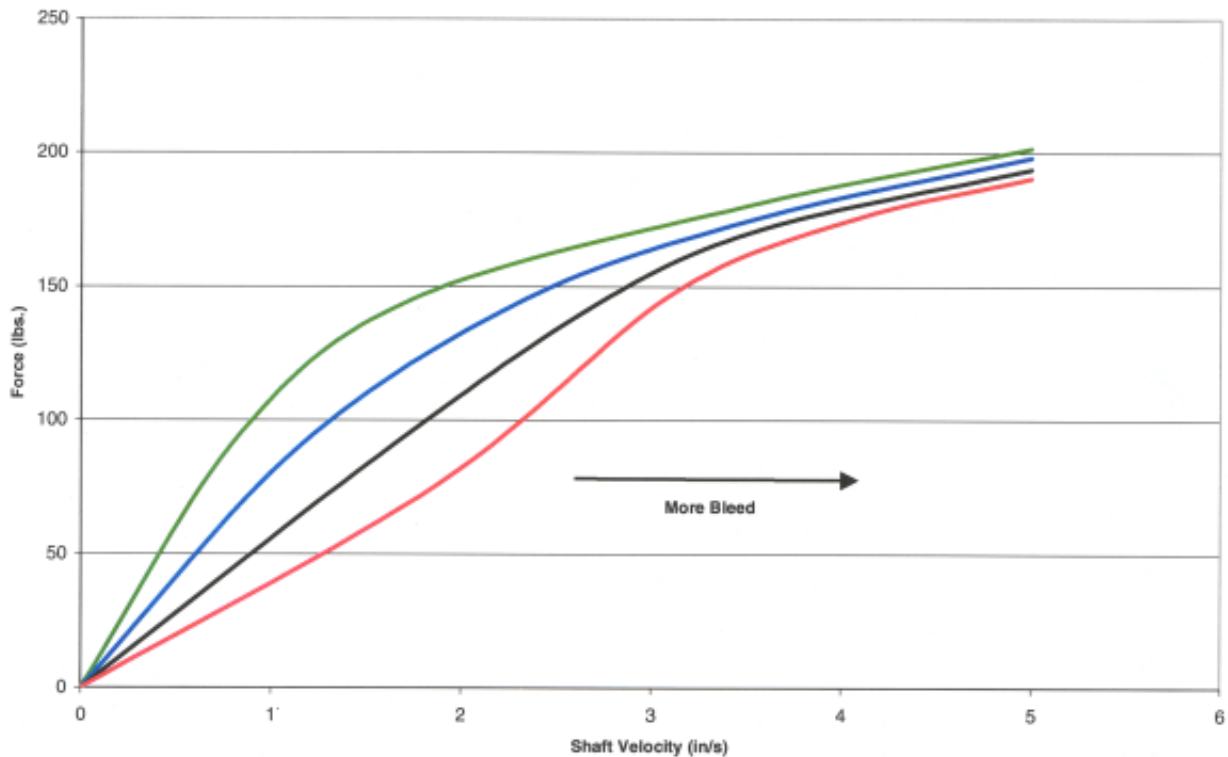

Figure 3

Bleed Adjustment



# Dyno Graph Overview

---

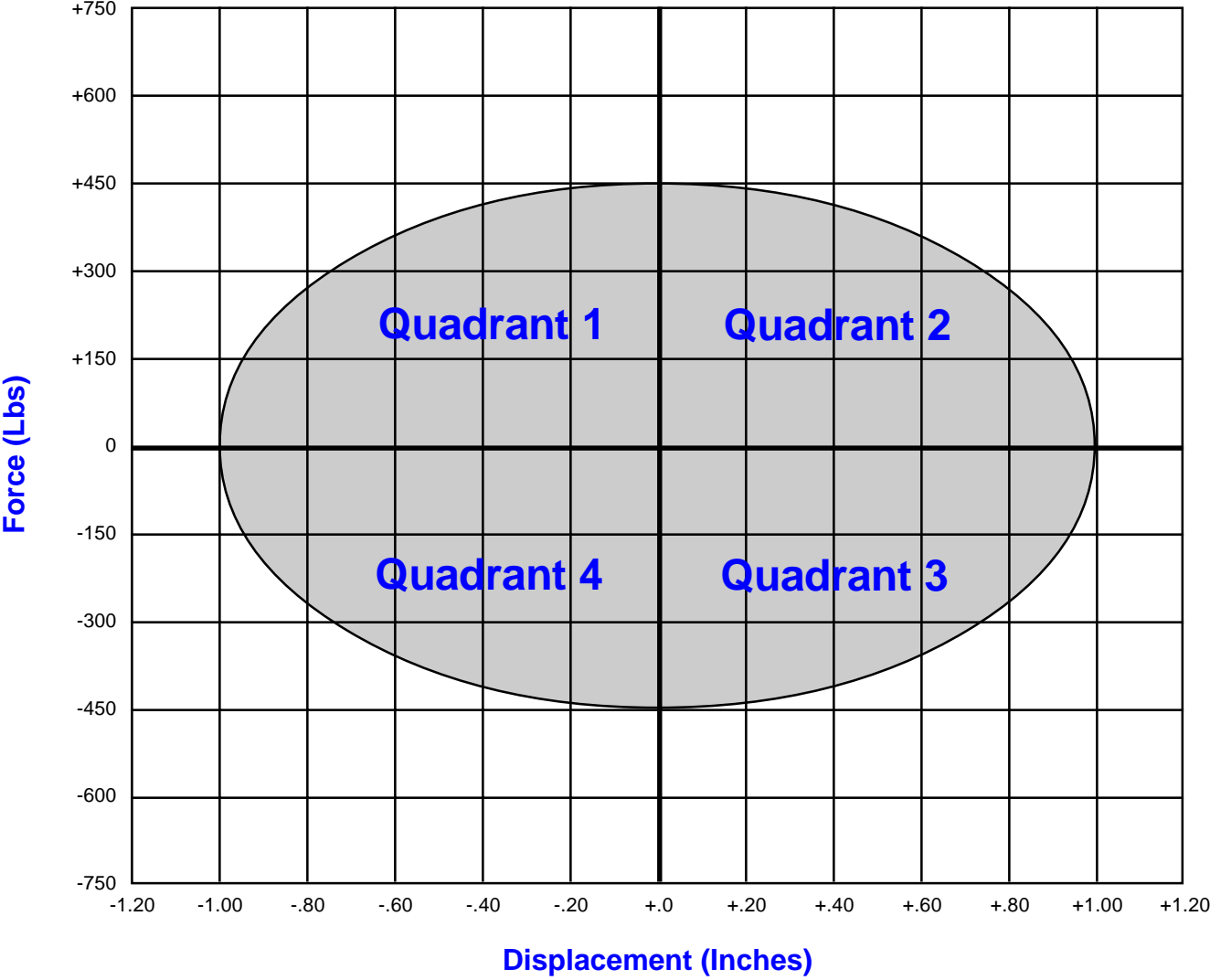

This section of the manual illustrates different valving combinations in the form of graphs. The graph shown is force vs. displacement graph. The force vs. displacement graph is a very accurate and simple way to assess valving characteristics. If you are not familiar with this type of graph, it is explained on the following page along with the graph above, showing the four different quadrants.

# Dyno Graph Overview

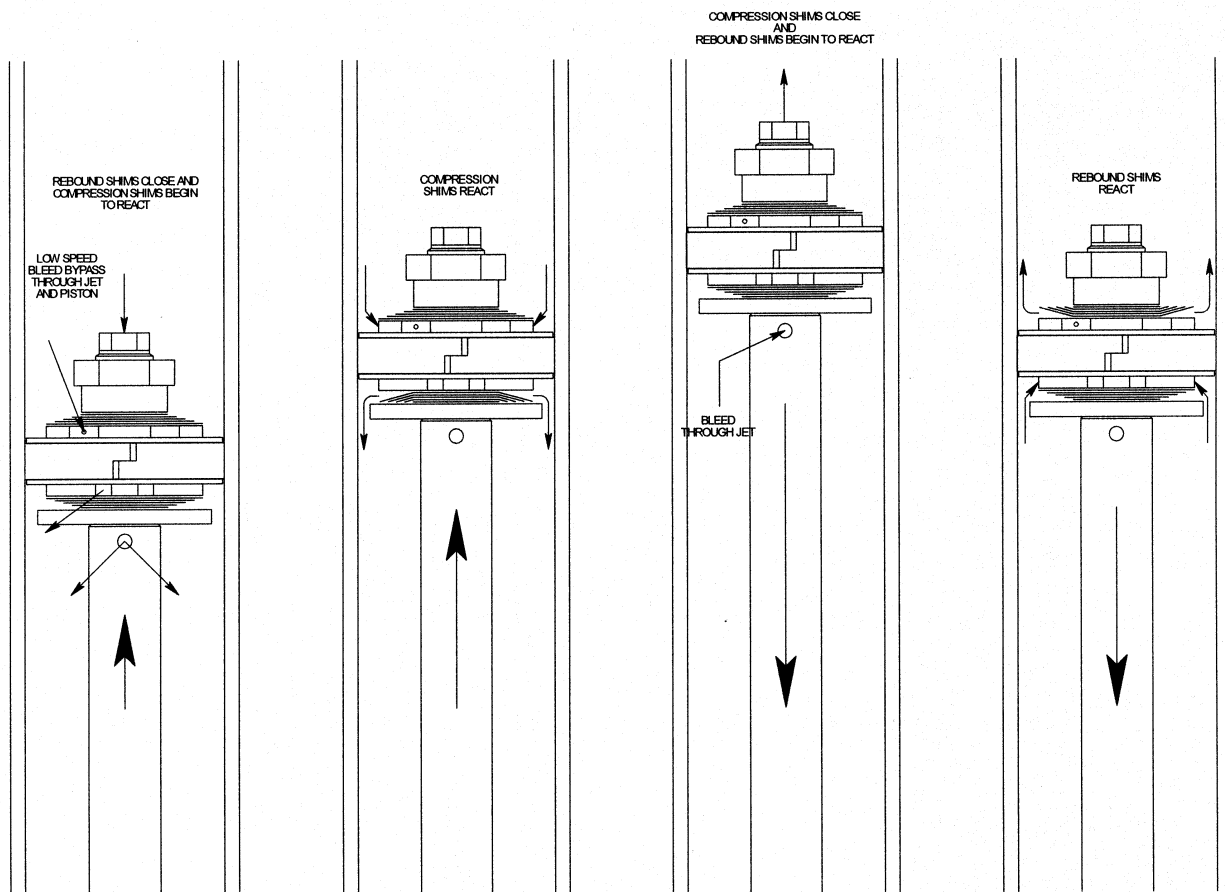

## QUADRANT #1

This is the beginning of the compression stroke. Where the graph crosses the zero line (pounds) in quadrant #1 begins the compression stroke. Approximately the first 1/2" of displacement is formed with relation to the low speed bleed bypass. When the shaft reaches a certain velocity, the low speed bleed bypass shuts off and the compression valve stack begins to react.

## QUADRANT #2

This quadrant begins with the compression valve stack open. Where the graph crosses the zero line (inches) in quadrant #2 is the maximum force produced by the compression valving. As the shock approaches the full compression point, the compression valve stack begins to close as it approaches the rebound movement.

## QUADRANT #3

This quadrant begins with the shock at full compression and the compression valve stack closed. Where the graph crosses the zero line (pounds) in quadrant #3 begins the rebound stroke. Approximately the first 1/2" of displacement is formed with relation to the rebound bleed through the shaft and jet. When the shaft reaches a certain velocity, the bleed shuts off and the rebound valve stack begins to react.

## QUADRANT #4

This quadrant begins with the rebound valve stack open. Where the graph crosses the zero line (inches) in quadrant #4 is the maximum force produced by the rebound valving. As the shock approaches the full extension point, the rebound valve stack begins to close as it approaches the compression movement. At this point the cycle starts over again in quadrant #1.

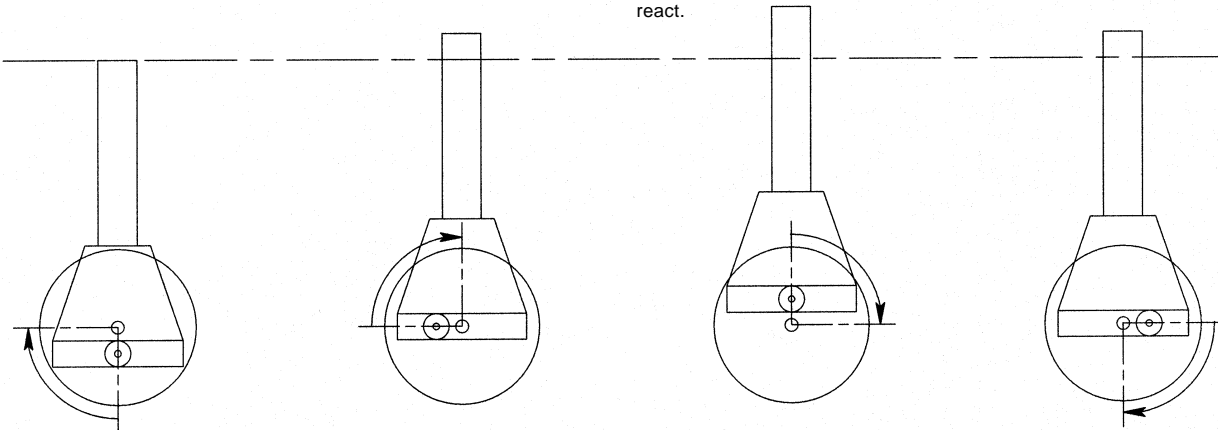

An easy way to help picture what is going on here is to relate the graph's shape to what the dyno is doing to the shock. The dyno uses a scotch yoke system (shown above), where the motor turns a crank and the sliding yoke allows the main dyno shaft to make the up and down movement at the preset stroke. The dyno software takes thousands of measurements throughout a single revolution of the crank. The sampled points are connected to form the graph. By relating the crank's position to the corresponding graph quadrant and the circular crank movement may help in reading the graphs.

# Dyno Graph Overview



## Force / Velocity Average

This graph shows the averages of the accelerating and decelerating compression and rebound forces. It is a good quick, general review of the shock curve, but is the least accurate of the options displayed.

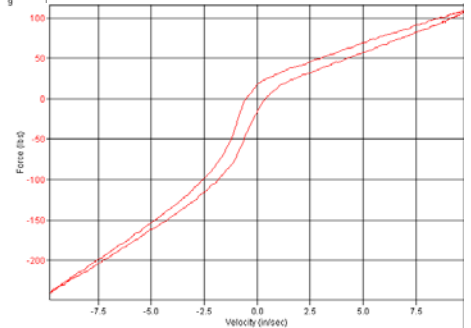
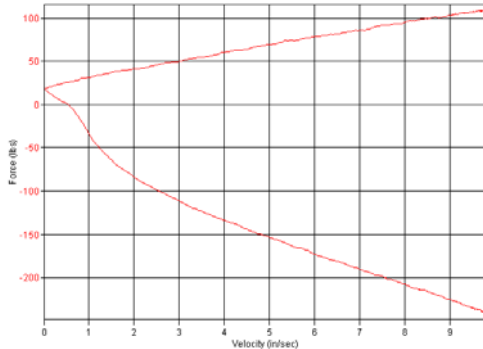
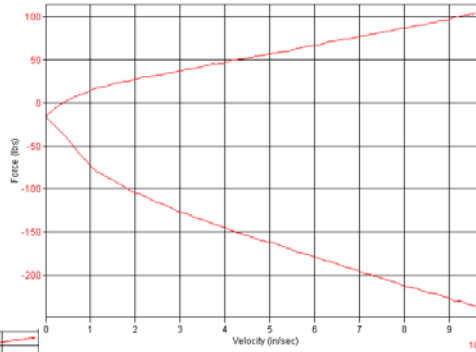

## Force / Velocity

This graph displays the accelerating and decelerating compression and rebound forces. Think of this graph as the Force / Displacement graph (below) folded in half.

\* Hysteresis is the gap between accelerating and decelerating compression and rebound damping. It is affected by the type of piston, the shims used and the relative position of high and low speed adjusters. The bleed hole will close the gap or soften the low speed forces.

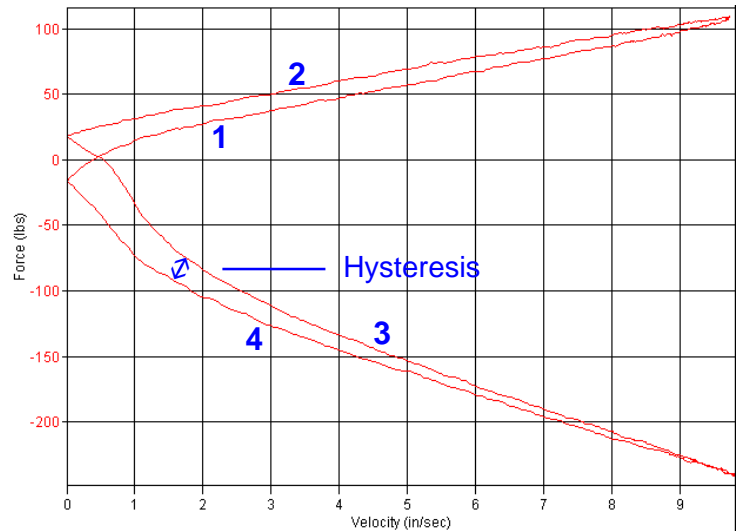

## OVAL (Force / Displacement)

### QUADRANT #1

This is the beginning of the compression stroke. Where the graph crosses the zero line (pounds) in quadrant #1 begins the compression stroke. Approximately the first 1/2" of displacement is formed with relation to the low speed bleed bypass. When the shaft reaches a certain velocity, the low speed bleed bypass chokes off and the compression valve stack begins to react.

### QUADRANT #2

This quadrant begins with the compression valve stack open. Where the graph crosses the zero line (inches) in quadrant #2 is the maximum force produced by the compression valving. As the shock approaches the full compression point, the compression valve stack begins to close as it approaches the rebound movement.

### QUADRANT #3

This quadrant begins with the shock at full compression and the compression valve stack closed. Where the graph crosses the zero line (pounds) in quadrant #3 begins the rebound stroke. Approximately the first 1/2" of displacement is formed with relation to the rebound bleed through the shaft and jet. When the shaft reaches a certain velocity, the bleed chokes off and the rebound valve stack begins to react.

### QUADRANT #4

This quadrant begins with the rebound valve stack open. Where the graph crosses the zero line (inches) in quadrant #4 is the maximum force produced by the rebound valving. As the shock approaches the full extension point, the rebound valve stack begins to close as it approaches the compression movement. At this point the cycle starts over again in quadrant #1.

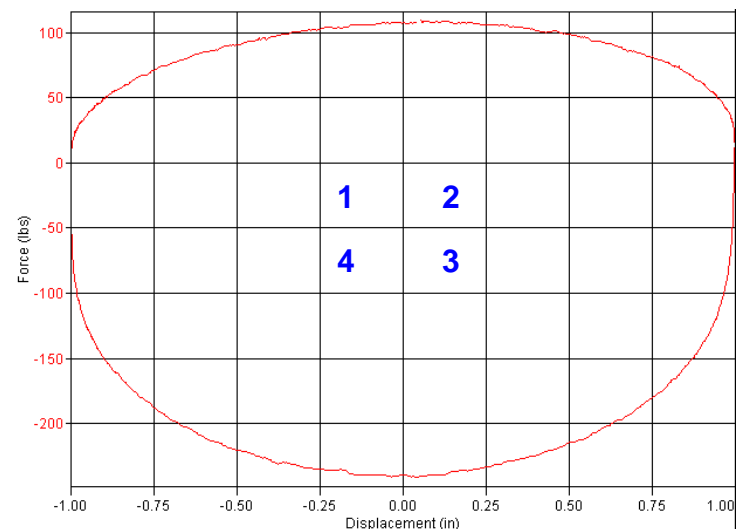

# Dyno Graph Overview

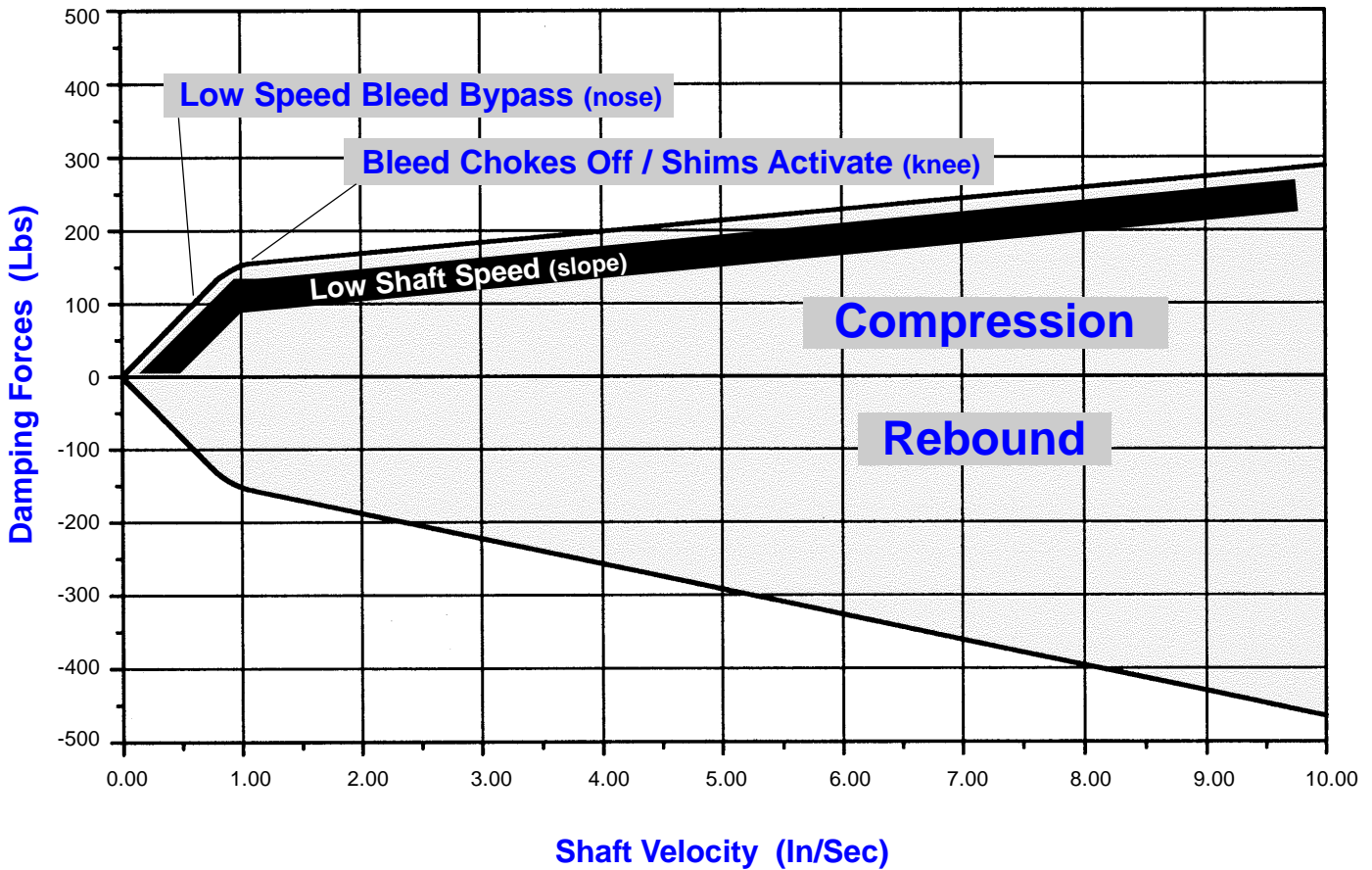

**Note:** Remember that low speed damping characteristics are controlled by bleed through the adjuster and the bleed hole in the piston, not the valve stacks.







### VDP - D/D or D/L

**LF**

Preload \_\_\_\_\_

_____	1.350	_____
_____	1.350	_____
_____	1.350	_____
_____	1.350	_____
_____	.750	_____
_____	.750	_____
_____	.750	_____
_____	.900	_____
_____	1.050	_____
_____	1.235	_____

Preload \_\_\_\_\_

_____	1.235	_____
_____	1.050	_____
_____	.900	_____
_____	.750	_____
_____	.750	_____
_____	.750	_____
_____	Stack	_____

**RF**

Preload \_\_\_\_\_

Piston Bleed

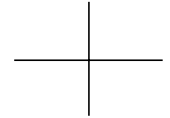

Jet

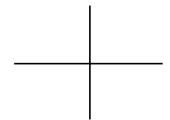

Preload \_\_\_\_\_

**LR**

Preload \_\_\_\_\_

_____	1.350	_____
_____	1.350	_____
_____	1.350	_____
_____	1.350	_____
_____	.750	_____
_____	.750	_____
_____	.750	_____
_____	.900	_____
_____	1.050	_____
_____	1.235	_____

Preload \_\_\_\_\_

_____	1.235	_____
_____	1.050	_____
_____	.900	_____
_____	.750	_____
_____	.750	_____
_____	.750	_____
_____	Stack	_____

**RR**

Preload \_\_\_\_\_

Gas Pressure

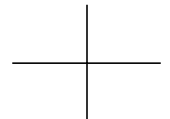

Clicks

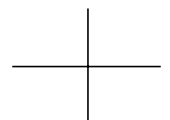

Preload \_\_\_\_\_

Notes:  
\_\_\_\_\_  
\_\_\_\_\_  
\_\_\_\_\_