

## ● CLEANING AND MAINTENANCE

1. The daily maintenance of computerized steam room should be cleaned with ordinary detergent and wet cloth with toothpaste. Please do not use the detergent of disinfection which contains acetone or formaldehyde when operating disinfection.
2. If there are furring on the surface of bathtub, it can be take away try to wipe the bathtub with lemon juice or vinegar which be heated.
3. In order to avoid damaging the surface of products please do not use hardness and sharpness tool to curve the products.
4. Do not wipe the chrome plated spare parts all the time, and do not get in touch with chemical detergent etc. Otherwise the surface of chrome finish will be destroyed. The product should be clean by soft cloth other than coarse cloth.
5. To check the water pipe regularly in order to avoid troubles from crack of water pipes or blocked inside .
6. If there are something such as hair stuck inside the jets, then just to twist out the jets and remove it.
7. Suggest to add the filter of water quality in order to make sure the normal operate of products if the water quality is worse in the local area.
8. keep out from combustibles and goods which over 80'C to avoid fire disaster and damage the product.
9. Please let the professional to operate when the steam generator needs to be replaced.
10. If the bathtub has not been used for a long time, drain out water of the bathtub and keep it in a dry and ventilate environment. Avoid corrosive gas.

- No advanced advice will be submit before we change our design and size.
- The pictures maybe a little different from the real products.
- Our company keep the final explanation right.



**Do not dispose this product as unsorted municipal waste. Collection of such waste separately for special treatment is necessary.**

# INSTALL DIRECTION

## STEAM BATHROOM

MODEL : WS-803A



Sanitary Ware Expert,  
Your best choice!

Dear Guest,

Thank you very much for purchasing our sanitary ware. To enable you to use this product safely and effectively, please read this installation and operation manual carefully before use.

**CAUTIONS**

1. Please ensure that the product installed reliable electric leakage protection device, the power plug contains earth line, and make sure it is reliable earth line. Check the protect system of leakage protection each time before use.
2. Do not turn on water pump, heat pump or air bubble pump without water.
3. Before turn on water pump, check if the water level over jets 10 to 20 mm or not, make sure regular usage of water pump otherwise it will be destroy because of water leakage.
4. People with Hypertension symptom, after drink or heart disease are not allowed to use the bathtub. Children have a bath must under adult's guidance.
5. During use please noticed that don't blocked the jets and avoiding the air adjustment valve overflowing. Also keep the bathtub clean and don't let it blocked by hair or mess.
6. During use, please firstly adjust the water temperature or it will be burned.
7. The bathtub is designed with ergonomic, rise and fall changes are quite big so during usage pay more attention of be slipped.
8. Please shut down the system when not to use.

**TECHNIQUE PARAMETER**

Voltage	Frequency	Water Volatge	Power of steam generator
AC220V( ±10%)	50/60Hz	0.1~0.2Mpa	3KW

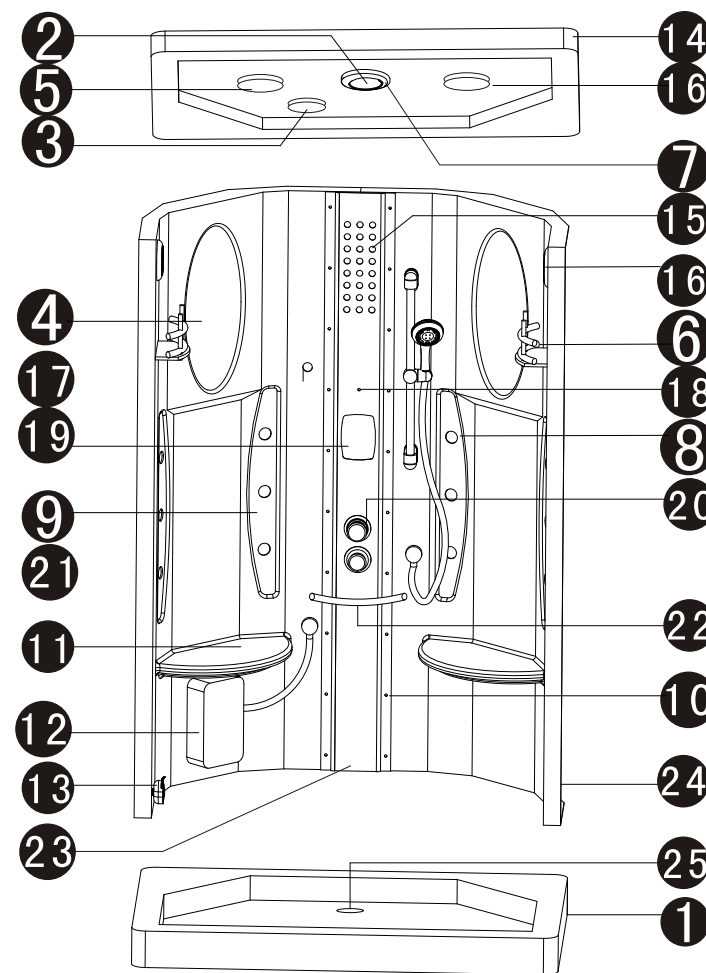
**BREAKDOWN PHENOMENON AND SETTLEMENT**

Phenomenon	Reasons	Maintenance
Without steam	<ol style="list-style-type: none"> <li>1. steam generator without water.</li> <li>2. inside infrared pipe burn out of steam generator.</li> <li>3. block of steam spray mouth.</li> <li>4. probe out off control.</li> <li>5. the temperature inside steam room is over the temperature what were set.</li> <li>6. after fill into water it is still not the time for steam working.</li> <li>7. it is overtime for the setting time.</li> <li>8. unconnect with the control wire.</li> </ol>	<ol style="list-style-type: none"> <li>1. check if the switch of water in be turn on or not.</li> <li>2. change the infrared pipe.</li> <li>3. get rid of mess.</li> <li>4. check the connection wire and change the probe.</li> <li>5. waiting decrease the temperature.</li> <li>6. be waiting few minutes.</li> <li>7. adjust the setting time.</li> <li>8. connect to control wire.</li> </ol>
Without O3	<ol style="list-style-type: none"> <li>1. system be damaged</li> </ol>	<ol style="list-style-type: none"> <li>1. change the system</li> </ol>
Water pipe leaking	<ol style="list-style-type: none"> <li>1. plastic seal ring be connected untightly.</li> <li>2. screws unlock.</li> <li>3. connection is glued not good.</li> <li>4. water pipe be damaged.</li> </ol>	<ol style="list-style-type: none"> <li>1. change the plastic seal ring.</li> <li>2. screws should be installed tightly.</li> <li>3. get rid of the PVC glue then stick the glue again till it is be well done.</li> <li>4. change the water pipe.</li> </ol>
Computer panel under control	<ol style="list-style-type: none"> <li>1. power not be connected well, electronic leakage device without power.</li> <li>2. switch of control panel out of control.</li> </ol>	<ol style="list-style-type: none"> <li>1. get through the power again.</li> <li>2. change the computer panel.</li> </ol>
Without lighting	<ol style="list-style-type: none"> <li>1. bulb be burned.</li> <li>2. without power.</li> <li>3. switch of control panel out of control.</li> </ol>	<ol style="list-style-type: none"> <li>1. change bulb.</li> <li>2. get through power gain.</li> <li>3. maintain or change the computer panel.</li> </ol>
Telephone connection unworking	<ol style="list-style-type: none"> <li>1. telephone wire not connected well or be damaged.</li> <li>2. telephone's device be blocked.</li> </ol>	<ol style="list-style-type: none"> <li>1. check the wires of telephone and electronic box if get through or not, if there is something wrong replace by the similar wires.</li> <li>2. get rid of mess.</li> </ol>
Without sounds	<ol style="list-style-type: none"> <li>1. speaker be broken</li> <li>2. without power</li> <li>3. switch of control panel out of control</li> </ol>	<ol style="list-style-type: none"> <li>1. change the speaker</li> <li>2. get through power again</li> <li>3. maintain or change the computer panel</li> </ol>

**ATTENTION**

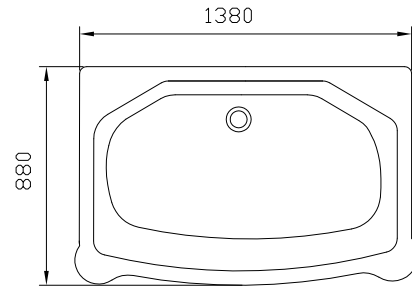
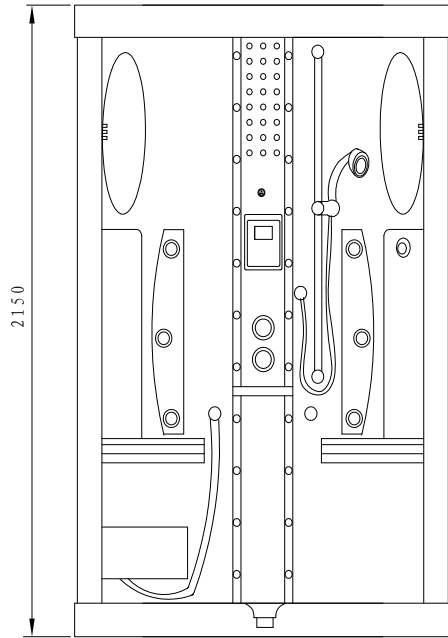
1. In order to be tripped and fell down, pay more attention when get into the steam room. Please don't shut the finger in the door in order to be hurt.
2. In order to avoid damaging the surface of products please do not use hardness and sharpness tool to curve the products.
3. In order to course fire, no smoking inside the bathroom.
4. the jets of steam and drainage pipe both are high temperature when products working, in order to be hurt please be careful.
5. In order to be tripped and fell down please keep clear of the bathtub after taking shower each time.
6. It will be leaking if the glass glue plastic sheet be off then please add some more for recover.
7. If there are marks of water please clear with soft cloth and toothpaste.
8. In order to be blocked of drainage device please keep clean of the surface of bathtub.
9. Please do not hang up heavy things on the steam room or the handle of steam room.
10. Please deal with the products according to the local laws when it is no longer be use.
11. Any request please contact with local dealer.

**SKETCH**

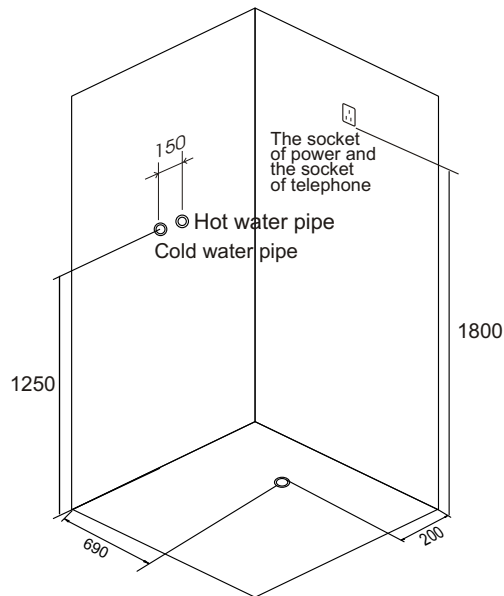


- |                       |                     |                           |
|-----------------------|---------------------|---------------------------|
| 1. bottom             | 10. nozzle          | 18. temperature sensor    |
| 2. top shower         | 11. seat            | 19. control panel         |
| 3. ozone              | 12. foot massage    | 20. switch                |
| 4. mirror             | 13. steam out       | 21. cold/hot water switch |
| 5. speaker            | 14. roof            | 22. handrail              |
| 6. handrail           | 15. decorated light | 23. decorated board       |
| 7. roof lamp          | 16. exhaust fan     | 24. room body             |
| 8. nozzle             | 17. moveable shower | 25. drainage              |
| 9. waist-shaped board |                     |                           |

INSTALLATION SKETCH



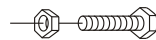
SIZE:1380x880x2150mm



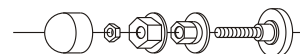
Specification  
SP4x15 ST5x25



Specification  
M6x25



Chain wheel of glass door



10. CD

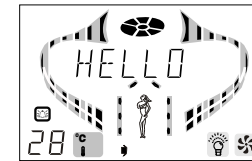
Press “” to turn on CD function,music comes out.Press again to turn off, Radio and CD function cannot power on at the same time.

11. Volume adjustment

Press “” to down the volume, press “” to up the volume .The switch of volume can be used for telephone,radio,and CD's volume

12.WARNING

In case of emergency, press “” ,there is showing warning label on the screen,sounds from speaker,at the same time turn off all the functions except light and exhaust fan these two function.Press again to turn off the warning function.



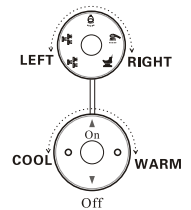
13.POWER OFF

Press “” there is showing in 3 minutes countdown. Meanwhile,water tank is draining out of all the water then will be turn off automatically.

14.TAKING SHOWER AND WATER-MASSAGE

Press the main switch of cold/hot water pipe then turn on the cold/hot switch to pour water into, to got the suitable water temperature what you like by adjust the shift valve.The function of the select shift (from left to right) is acupuncture water-massage,acupuncture water-massage roof shower bath,movable shower bath,sole-massage bath,turn on the shift switch and select functions what you like.

SHIFT VALVE



WATER SWITCH


15.foot massage

Place the foot massage to a suitable place, then turn the switch valve to the foot massage function. Turn on the hot/cold water switch for foot massage and adjust to suitable water temperature. Turn off the foot massaging function by switch off the water supply.

16.STOP WATER SUPPLY


After finish shower, turn the switch valve back to the original place, turn off the hot/cold water switch, then switch off the general external switch of water supply of the steam room.

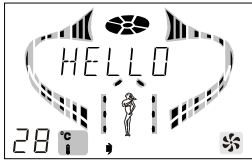
**6.OZONE STERILIZATION**

Press “” to turn on ozone sterilization function, press this button again or after 10 minutes lasting work, then ozone sterilization will be turn off. Other functions cannot be turn on when ozone sterilization be turn on because of other functions be locked by each other except ozone sterilization and lighting.




**CAUTION:** It is best to turn on ozone sterilization after taking the shower.


**7.EXHAUST FAN**


Press “” to turn on exhaust fan,there showing exhaust fan's logo on the screen,press this button again to turn off.

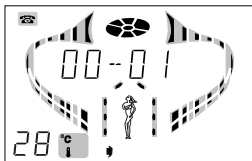


**8.TELEPHONE**





Call: press “” then press telephone numbers, there showing those numbers what you've dialed on the screen, you can speaking towards to the microphone when get through phone calls. Press “” “” to up and down the volume.

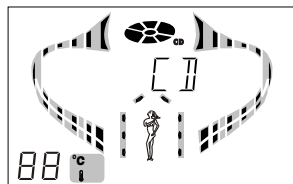
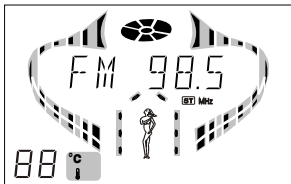
Pick up phone call: when telephone ringing, press “” to pickup.

Hang up phone call: Press “” to hang up phone calls after finished conversation.



**9.FM RADIO**

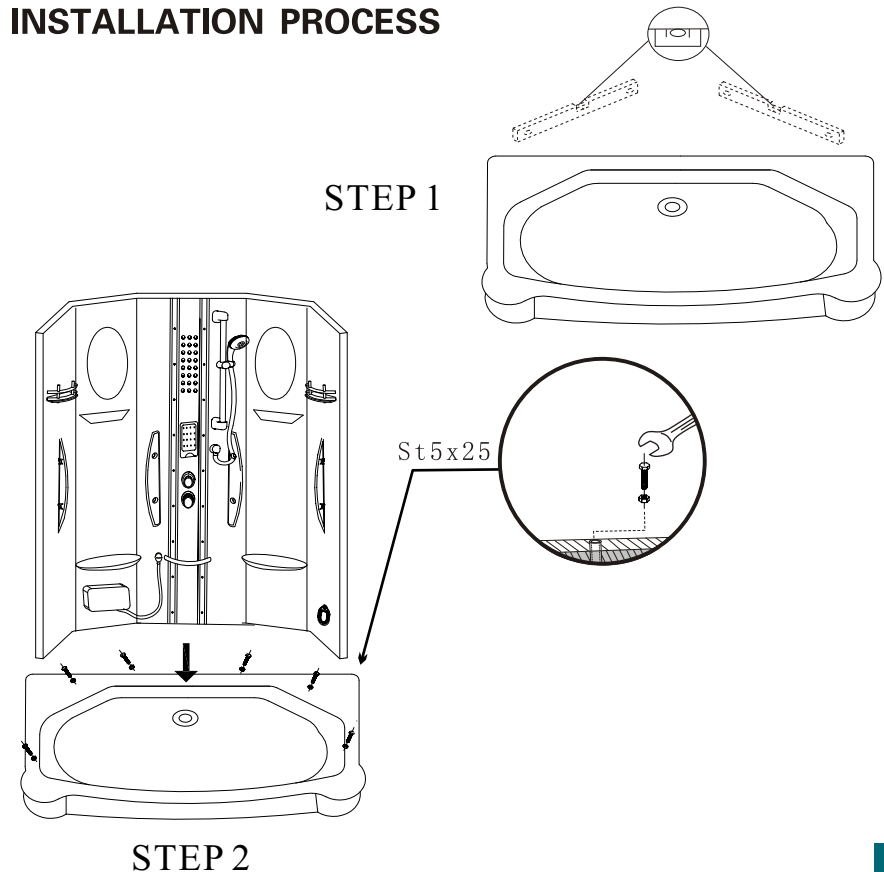
Press “” into FM Radio function, sounds come from speaker.Press “” “” to search channel by manual acting, press half second then that is channel searching automatically. Press “” again to turn off FM.

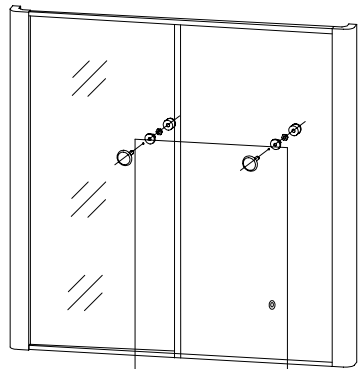


**ILLUSTRATION OF INSTALLATION**

- 1.The products should be installed by technical guy who are got the certificate or those technical who are assign by dealers. The main power switch and electronic leakage device should be installed.
- 2.The plug of electronic should be installed above the steam generator and the length of electronic wire not less then 1800MM from the earth.
- 3.There are should be with main power switch for hot and cold water pipe of steam room and the water pipe should be connect to drainage water pipe.
- 4.Install the products according to the diagram of installation When fixed the place for the products.

**INSTALLATION PROCESS**



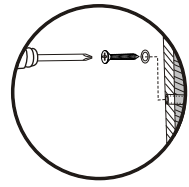
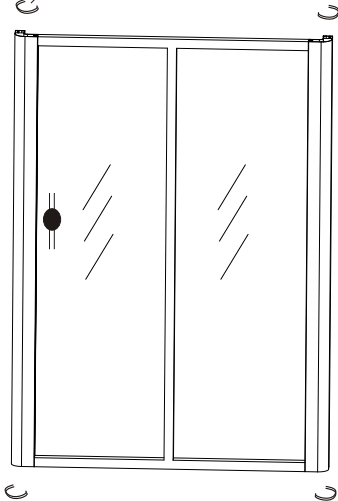


Chain wheel of glass door

STEP 3

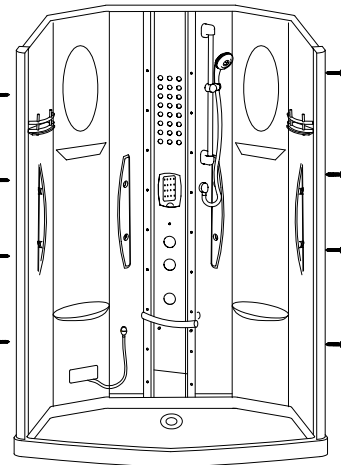


Plastic pad



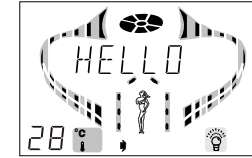
SP4 x 25

STEP 4



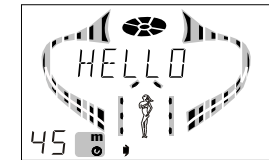
**2.LIGHT**

Press “” turn on top lamp and wall lamp at the same time. It showing corresponding logos,press the button again to turn off.



**3.STEAM**

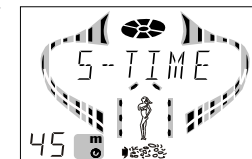
Press “” to turn on steam function,it showing steam logo,water tank will fill water into automatically and will produce steam within one minute. Steam function don't work without water in water tank,and logo flashing will be show in the screen.There is an normal phenomenon that it will produce steam again when steam stop several minutes after working in a certain time.Press this button again to turn off steam function.



The situation without water

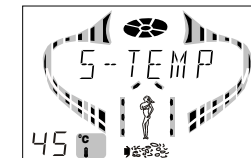
**4.Time setting**

Press “” into time setting function,45 minutes will be set by system,then press “” “” to up and down the timing of steam adjusted, the range can be 5 to 60 minutes or work lasting.steam start to be count down after setting time,steam will be stop working automatically when it is count down to zero.



**5.TEMPERATURE SETTING**

Press “” into temperature setting,there showing the logo of steam and the temperature will be set for 45 minutes by system, press “” “” into up and down the temperature adjustment, the range is 30 to 60 degree. The steam will be stop automatically when the inside temperature will reach to the setting temperature.




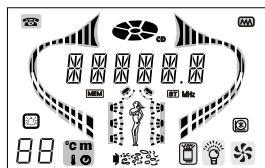
**ATTENTION FOR USAGE**

- 1、 check if power and cold/hot water switch be turn on or be turn off each time before use this product.
- 2、 check if power of electronic leakage device be get through or not.  
Checking way:  
Press testing button, light of power be off, press button of restart then light of power be on.It is not being what mentioned above after operated step by step,then that shows the electronic protection device out off control or there is something wrong with the electronic leakage device,so should ask professional to check and maintain the product.
- 3、 Turn off the main power of control panel after stop usage. The plug of power should be pull out because only turn off all the functions of control panel that is not stop the power.
- 4、 People with hypertension or drunk are not allowed to have sauna steam bath.
- 5、 Children should have sauna steam bath under adult's instruction.
- 6、 Please don't shut the finger in the door in order to be hurt when get into the steam room.
- 7、 In order to be tripped and fell down, pay more attention when get into the steam room.
- 8、 keep clean of the tray in order to be tripped and fell down.
- 9、 Pay attention to the steam sprayer and water tank drainage, they are in high temperature while working.

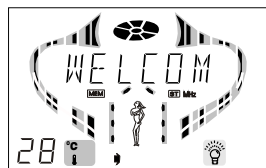
**USAGE ILLUSTRATION**

**1.POWER ON**

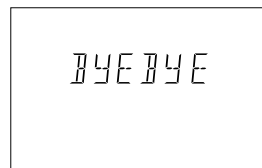
Get through power turn on “” on the screen of control panel.Top light be on,screen lighting, showing temperature and logo of lighting after within 3-6 seconds being data of self-checking,meanwhile power on other functions,press this button again to power off all functions but that is not cut the power.



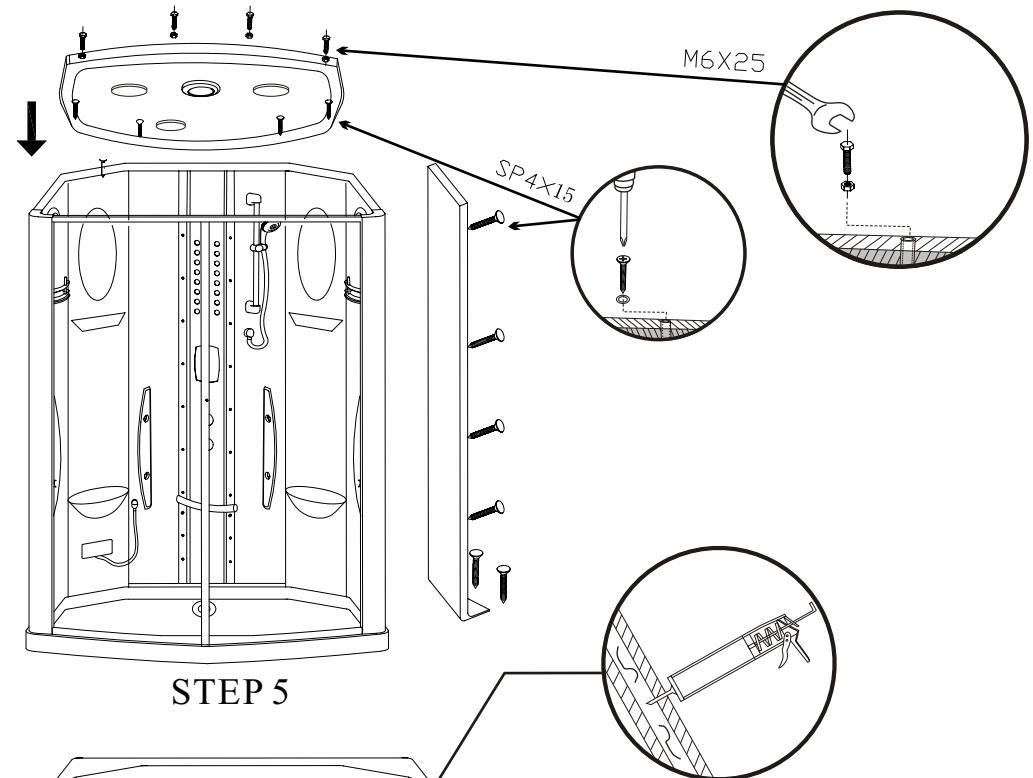
Showing all the logo's lighting



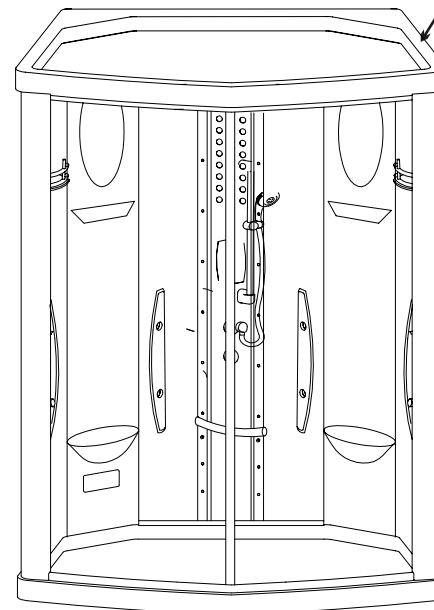
Showing checking be finished



Showing power off



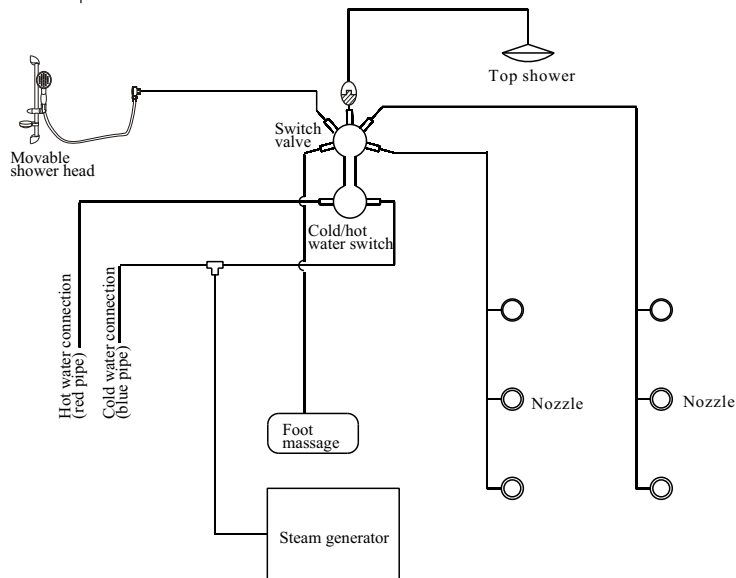
STEP 5



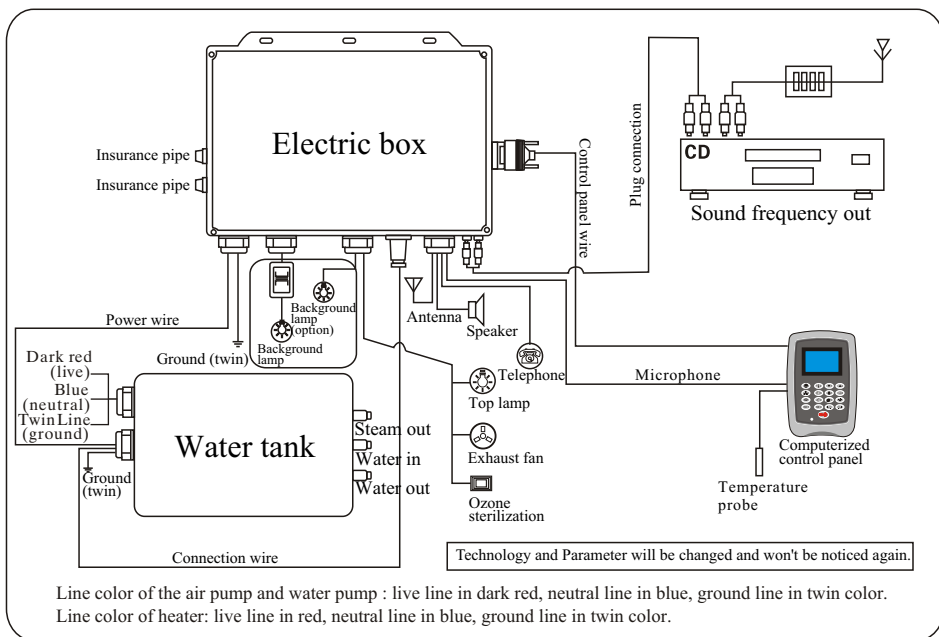
STEP 6

### DRAWING OF WATER CONNECTION

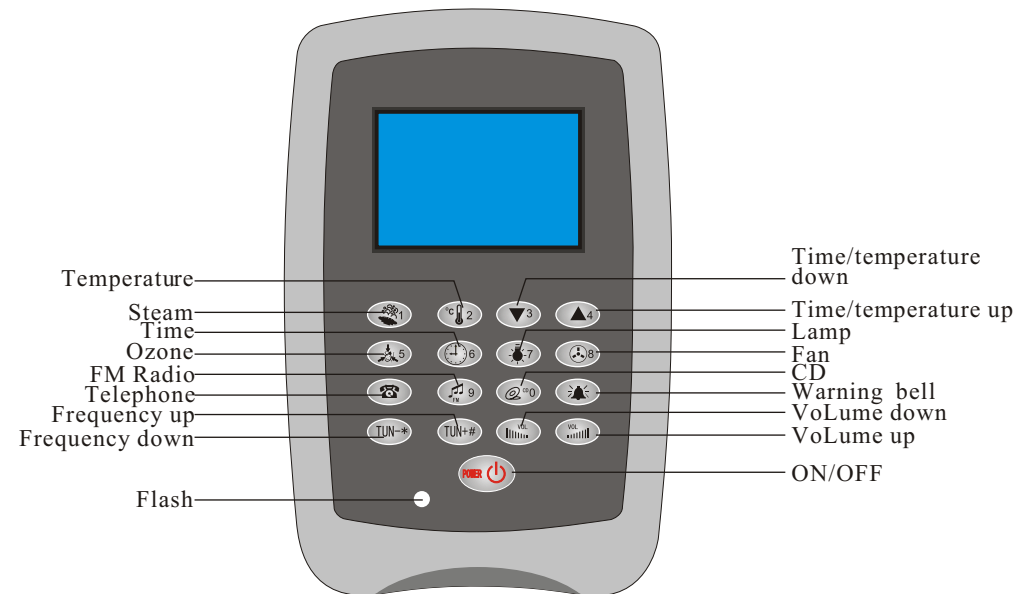
As the “ ” from the picture, please make the connection according to the serial number v1,v2,etc.



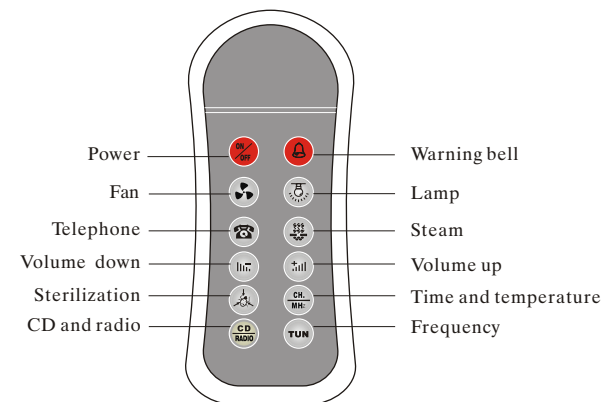
### DRAWING OF ELECTRICITY CONNECTION



### MANUAL



CONTROL PANEL



Remote Control

1. control remote with functions of water-proof and damp-proof.
2. usage of control remote are similarity with computer panel's function 1 to 12.
3. the effect of usage distance will be 5 meter.
4. please don't fall the control remote.