



10000 Watt Generator

Owner's Manual



Model No. PG10000B

For Service Please Call Toll Free: 1-866-591-8921

⚠ WARNING ⚠

Read and follow all safety rules and instructions in this manual before attempting to operate this machine. Failure to comply with these instructions may result in personal injury.

Diagrams within this manual may not be drawn proportionally. Due to continuing improvements, actual product may differ slightly from the product described herein.

10000W Generator

Table of Contents

Topic	Page
Safety Guidelines	3
General Precautions	4
General Parts	12
Battery	13
Operation	14
Inspection, Cleaning and	23
Maintenance Installation	24
Troubleshooting	26
Specifications	27
Wiring Diagram	28

Safety Guidelines - Definitions

This manual contains important information that you need to know and understand in order to protect YOUR SAFETY and to PREVENT EQUIPMENT PROBLEMS. The following symbols help you recognize this information. Please read the manual and pay attention to these sections.

Save These Important Safety Instructions!

Read and understand all of these safety instructions. Be sure to retain them for future use.



WARNING! WARNINGS INDICATE A CERTAINTY OR STRONG POSSIBILITY OF PERSONAL INJURY OR DEATH IF INSTRUCTIONS ARE NOT FOLLOWED.



CAUTION: CAUTIONS INDICATE A POSSIBILITY OF EQUIPMENT DAMAGE IF INSTRUCTIONS ARE NOT FOLLOWED.



NOTE: NOTES GIVE HELPFUL INFORMATION



WARNING! IMPROPER OPERATION OR MAINTENANCE OF THIS PRODUCT COULD RESULT IN SERIOUS INJURY AND PROPERTY DAMAGE. READ AND UNDERSTAND ALL WARNINGS AND OPERATING INSTRUCTIONS BEFORE USING THIS EQUIPMENT. WHEN USING AIR TOOLS, BASIC SAFETY PRECAUTIONS SHOULD ALWAYS BE FOLLOWED TO REDUCE THE RISK OF PERSONAL INJURY.

General Precautions



WARNING! FAILURE TO FOLLOW THESE INSTRUCTIONS CAN RESULT IN SEVERE INJURY OR DEATH.



CAUTION: FAILURE TO FOLLOW THESE INSTRUCTIONS CAN ALSO RESULT IN DAMAGE TO THE TOOL AND/OR THE ITEM YOU ARE WORKING ON.

Carbon Monoxide

When this tool is running, ensure that the area is well ventilated. Never run the engine in an enclosed area. Run the engine in an open area or with an exhaust evacuation system in an enclosed area.



WARNING! THE EXHAUST CONTAINS POISONOUS CARBON MONOXIDE GAS THAT CAN CAUSE LOSS OF CONSCIOUSNESS AND MAY LEAD TO DEATH.

Gasoline and Oil

This product requires oil and fuel. Attempting to start the engine without oil will ruin the engine and void the warranty. Work in a well ventilated area. Keep cigarettes, flames or sparks away from the work area or where gasoline is stored.



WARNING! GASOLINE IS EXTREMELY FLAMMABLE AND IS EXPLOSIVE UNDER CERTAIN CONDITIONS. KEEP OUT OF REACH OF CHILDREN.

- Gasoline fuel and fumes are flammable and potentially explosive. Use proper fuel storage and handling procedures. Always have multiple ABC class fire extinguishers nearby.
- Keep the generator and surrounding area clean at all times.
- Fuel or oil spills must be cleaned up immediately. Dispose of fluids and cleaning materials as per any local, state, or federal codes and regulations. Store oily rags in a covered metal container.
- Never store fuel or other flammable materials near the generator.

General Precautions

Gasoline and Oil

- Do not smoke, or allow sparks, flames or other sources of ignition around the engine and fuel tank. Fuel vapors are explosive.
- Keep grounded conductive objects, such as tools, away from exposed, live electrical parts and connections to avoid sparking or arcing. These events could ignite fumes or vapors.
- Do not refill the fuel tank while the engine is running or while the engine is still hot. Do not operate the generator with known leaks in the fuel system
- Excessive buildup of unburned fuel gases in the exhaust system can create a potentially explosive condition. This buildup can occur after repeated failed start attempts, valve testing, or hot engine shutdown. If this occurs, open exhaust system drain plugs, if equipped, and allow the gases to dissipate before attempting to restart the generator.
- only use engine oil and fuel recommended by manufacturer.

Hot Components



WARNING! ENGINE AND EXHAUST SYSTEM PARTS BECOME VERY HOT AND REMAIN HOT FOR SOME TIME AFTER THE ENGINE HAS STOPPED INSULATED GLOVES OR WAIT UNTIL THE ENGINE AND EXHAUST SYSTEM HAVE COOLED BEFORE HANDLING THESE PARTS.

Power Output

This generator is not designed to power sensitive electronic equipment (including computers and medical devices) without the addition of an approved line conditioner, which is sold separately.



CAUTION: ATTEMPTING TO POWER SENSITIVE ELECTRONIC EQUIPMENT WITHOUT THE USE OF AN APPROVED LINE CONDITIONER MAY CAUSE DAMAGE TO THE EQUIPMENT. PULSAR PRODUCTS INC. IS NOT RESPONSIBLE FOR ANY DIRECT OR INDIRECT DAMAGE CAUSED BY FAILURE TO USE AN APPROVED LINE CONDITIONER.

General Precautions

Work Area

- Keep your work area clean and well lit. Cluttered benches and dark areas invite accidents.
- Do not operate power tools in explosive atmospheres, such as in the presence of flammable liquids, gases, or dust. Generators create sparks which may ignite the dust or fumes.
- Keep bystanders, children, and visitors away while operating a generator. Provide barriers or shields as needed.

Electrical Safety

- Grounded tools must be plugged into an outlet properly installed and grounded in accordance with all codes and ordinances. Never remove the grounding prong or modify the plug in any way. Do not use any adapter plugs.
- Grounding provides a low-resistance path to carry electricity away from the user in the event of an electrical malfunction.
- Double insulated tools are equipped with a polarized plug, where one blade is wider than the other. This plug fits in a polarized outlet only one way. If the plug does not fit fully in the outlet, reverse the plug. If it still does not fit, contact a qualified electrician to install a polarized outlet. Do not change the plug in any way. Double insulation eliminates the need for the three-wire grounded power cord and grounded power supply system.
- Avoid body contact with grounded surfaces such as pipes, radiators, ranges, and refrigerators. There is an increased risk of electric shock if your body is grounded.
- Do not expose generator to rain or wet conditions. Water entering a generator will increase the risk of electric shock.
- Do not abuse the power cord. Keep power cords away from heat, oil, sharp edges, or moving parts. Replace damaged power cords immediately. Damaged power cords increase the risk of electric shock.
- When operating a power tool outside, use an outdoor extension cord marked “W-A” or “W”. These extension cords are rated for outdoor use, and reduce the risk of electric shock.



General Precautions

Electrical Safety

- All connections and conduits from the generator to the load must only be installed by trained and licensed electricians, and in compliance with all relevant local, state, and federal electrical codes and standards, and other regulations where applicable.
- The generator must be earth-grounded for fixed installations in accordance with all relevant electrical codes and standards before operation.
- Do not attempt to connect or disconnect load connections while standing in water, or on wet or soggy ground.
- Do not touch electrically energized parts of the generator and interconnecting cables or conductors with any part of the body, or with any non-insulated conductive object.
- Connect the generator only to a load or electrical system (120 volt) that is compatible with the electrical characteristics and rated capacities of the generator.
- Before servicing equipment powered by the generator, disconnect the equipment from its power input.
- Keep all electrical equipment clean and dry. Replace any wiring where the insulation is cracked, cut abraded or otherwise degraded. Replace terminals that are worn, discolored, or corroded. Keep terminals clean and tight.
- Insulate all connections and disconnected wires.
- Guard against electric shock. Prevent body contact with grounded surfaces such as pipes, radiators, ranges, and refrigerator enclosures.

Personal Safety

- Stay alert. Watch what you are doing, and use common sense when operating a generator. Do not use generator while tired or under the influence of drugs, alcohol, or medication. A moment of inattention while operating generators may result in serious personal injury.
- Dress properly. Do not wear loose clothing or jewelry. Contain long hair. Keep your hair, clothing, and gloves away from moving parts. Loose clothes, jewelry, or long hair can be caught in moving parts.

General Precautions

Personal Safety

- Avoid accidental starting. Make sure the power switch is in its “OFF” position and disconnect the spark plug wire when not in use.
- Remove adjusting keys or wrenches before turning the generator on. A wrench or a key that is left attached to a rotating part of the generator may result in personal injury.
- Do not overreach. Keep proper footing and balance at all times.
- Use safety equipment. Always wear eye protection. Wear ANSI approved safety impact eye goggles. Dust mask, non-skid safety shoes, hard hat, or hearing protection must be used for appropriate conditions.
- Do not force the generator. Use the correct generator for your application. The correct generator will do the job better and safer at the rate for which it is designed.
- Do not use the generator if the power switch does not turn it on or off. Any generator that cannot be controlled with the power switch is dangerous and must be replaced.

Generator Use and Care

Make sure the power switch is in its “OFF” position and disconnect the spark plug wire before making any adjustment, changing accessories, or storing the generator. Such preventative safety measures reduce the risk of starting the generator accidentally.

Store idle generators out of reach of children and other untrained persons. Generators are dangerous in the hands of untrained users.

Maintain generators with care. Do not use a damaged generator. Tag damaged generators “Do not use” until repaired.

Check for misalignment or binding of moving parts, breakage of parts, and any other condition that may affect the generator’s operation. If damaged, have the generator serviced before using. Many accidents are caused by poorly maintained generators.

Use only accessories that are recommended by the manufacturer for your model. Accessories that may be suitable for one generator may become hazardous when used on another generator.

General Precautions

Servicing

Maintain labels and name plates on the generator and engine. These carry important information. If unreadable or missing, contact Pulsar Products Inc. Immediately for a replacement.

Generator service must be performed only by qualified repair personnel. Service or maintenance performed by unqualified personnel could result in a risk of injury.

When servicing a generator, use only identical replacement parts. Follow all appropriate instructions in this manual. Use of unauthorized parts or failure to follow maintenance instructions may create a risk of electric shock or injury.

Heart Pacemakers



WARNING! PEOPLE WITH PACEMAKERS SHOULD CONSULT THEIR PHYSICIAN(S) BEFORE USING THIS PRODUCT. ELECTROMAGNETIC FIELDS IN CLOSE PROXIMITY TO A HEART PACEMAKER COULD CAUSE INTERFERENCE TO OR FAILURE OF THE PACEMAKER.

Installation

- Ensure installation meets all applicable safety, local and national electrical codes. Have installation performed by a qualified, licensed electrician and building contractor.
- All electrical work, including the earth-ground connection, should be completed by a licensed electrician.
- Any separate fuel storage or generator supply facility must be built or installed in full compliance with all relevant local, state, and federal regulations.
- It is recommended to use the generator only in well ventilated, outdoor areas. A running gasoline engine will generate carbon monoxide, a colorless, odorless gas that, if inhaled, can cause serious injury or death. If the generator is installed indoors, exhaust fumes must be piped out of the building using leak-free, heat resistant piping. Pipes and silencer should not use any flammable materials, nor should they be installed near the same. Generator exhaust fumes must be within legal limits and installation must always meet local building codes.

General Precautions

Installation

- If the generator is installed outdoors, it must be weatherproofed and should be soundproofed. It should not be run outdoors without protection to the generator and wiring conduit.
- The generator weighs 212lbs (approximately) . Two or more people should assist when moving or lifting this product. Never lift the generator using the engine or alternator lifting lugs. Connect lifting equipment to the frame of the generator
- Before lifting the generator, ensure the lift rigging and supporting structure are in good condition, and are rated to lift such a load.
- Keep all personnel away from the suspended generator during relocating.
- The supporting floor/ground surface should be level and strong enough to safely hold the weight of the generator. If the floor/grounded surface is not level, strong cross members should be placed under the full length of the generator frame at its low side.
- For trailer installation, the generator should be mounted on the center point of the trailer, over the wheels. The trailer must be capable of supporting the weight of the generator and all contents (tools, etc.)
- Install sound-and weather-proofing only when it is not raining or snowing to avoid trapping moisture within the generator's area.

Mechanical

- Always make sure the power switch is in its “OFF” position. Disconnect the spark plug wire, and allow the engine to completely cool before carrying out maintenance.
- Check for damaged parts. Before using the generator, any part that appears damaged should be carefully checked to determine that it will operate properly and perform its intended function. Check for alignment and binding of moving parts, any broken parts or mounting fixtures, and any other condition that may affect proper operation.
- The generator is designed with guards for protection from moving parts. Care must still be taken to protect personnel and equipment from other mechanical hazards when working around the generator.

General Precautions

Mechanical

- Do not operate the generator with safety guards removed. While the generator is running, do not attempt to reach around the safety guard for maintenance or any other reason.
- Keep hands, arms, long hair, loose clothing, and jewelry away from moving parts. Be aware that when engine parts are moving fast they cannot be seen clearly.
- Keep access doors on enclosures closed and locked when access is not required.
- When working on or around the generator, always wear protective clothing, including ANSI approved safety gloves, safety eye goggles, and safety hat.
- Do not alter or adjust any part of the generator that is assembled and supplied by the manufacturer.
- Always follow and complete scheduled engine and generator maintenance.

Chemicals

- Avoid contact with hot fuel, oil, exhaust fumes, and hot solid surfaces.
- Avoid body contact with fuels, oils, and lubricants used in the generator. If swallowed, seek medical treatment immediately. Do not induce vomiting if fuel is swallowed. For skin contact, immediately wash with soap and water. For eye contact, immediately flush eyes with clean water and seek medical attention.

Noise

- Prolonged exposure to noise levels above 68 DBA is hazardous to hearing. Always wear ANSI approved ear protection when operating or working around the generator when it is running.

General Parts

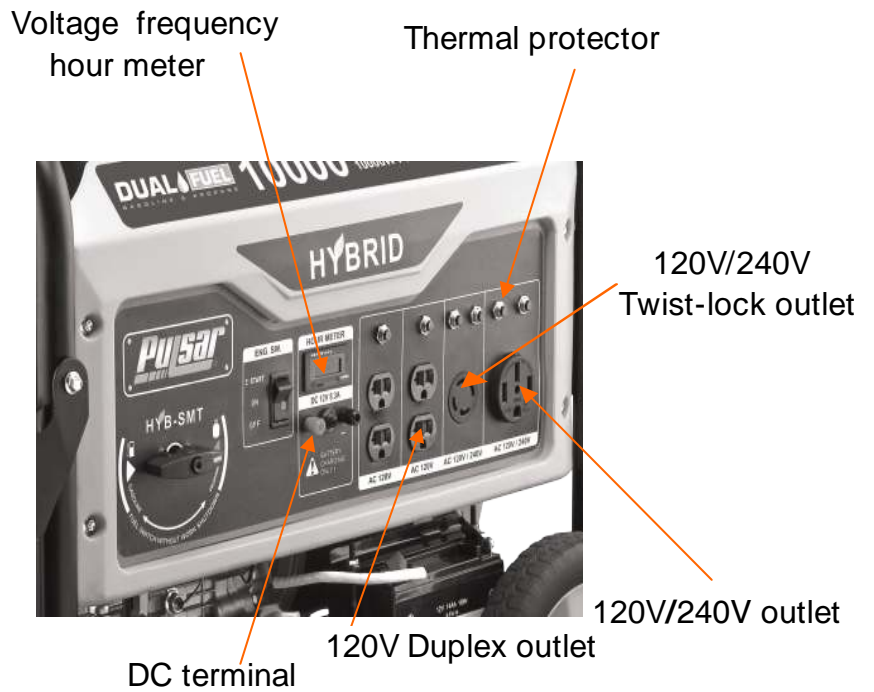
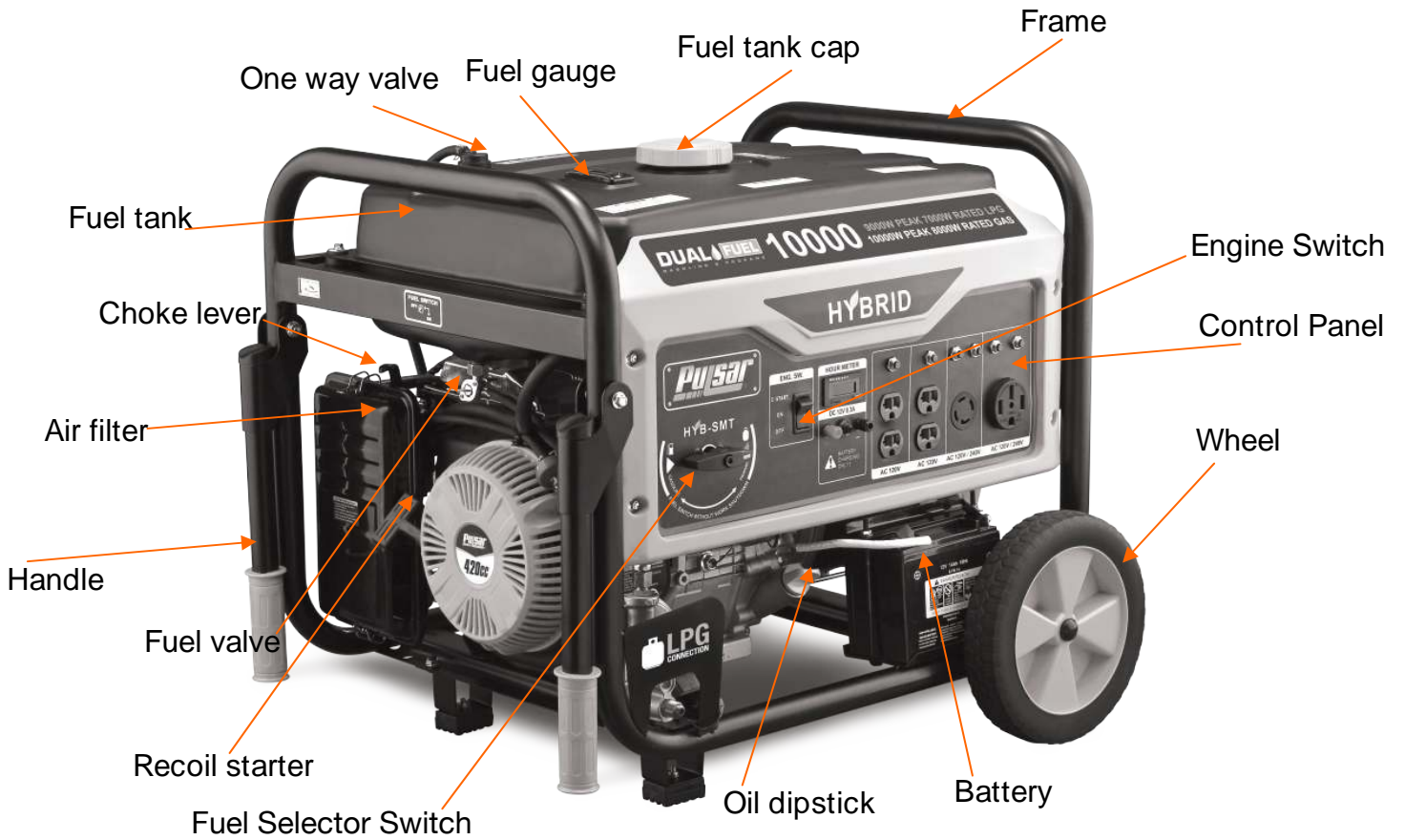

Battery

To start generator with electric start you will need a battery (included) .

Also this generator can also be started with the pull start. Note: Using a battery not designed for this unit may void warranty. Photos below demonstrate battery plate attachment.



Put the battery on the frame, have the battery assembled with the provided accessories as shown.

Operation



NOTE: THE PARTS LISTED ABOVE ARE HELPFUL FOR LOCATING THE CONTROLS MENTIONED BELOW.



CAUTION: PRIOR TO FIRST USING THE GENERATOR, THE ENGINE MUST BE FILLED WITH A HIGH QUALITY SAE 10W30 GRADE ENGINE OIL. TO DO SO, UNSCREW AND REMOVE THE ENGINE'S OIL DIPSTICK LOCATED AT THE BOTTOM OF THE ENGINE CRANKCASE. FILL THE ENGINE'S CRANKCASE UNTIL THE OIL LEVEL IS LEVEL WITH THE UPPER MARKED LINE ON THE DIPSTICK. THEN SCREW THE DIPSTICK BACK INTO THE OIL FILL HOLE.

Before Starting the Generator

1. Check that the engine power switch is in the "OFF" position.
2. Before the first use, remove the fuel tank cap and fill the fuel tank with unleaded gasoline. When fueling, be sure that the fuel strainer is in place. Replace the fuel tank cap. Thereafter, check the engine's fuel gauge for the amount of unleaded gasoline in the fuel tank. If necessary, refill the fuel tank with unleaded gasoline; the generator must be turned off and cooled down before refilling the fuel tank.



Operation

Connecting to LPG Fuel Source

1. Locate the LPG converter on the backside of the generator
2. Attach small end of the Gas Hose to the LPG converter.
3. Connect gas hose to propane fuel source. Do not turn on propane source prior to following the steps outlined.

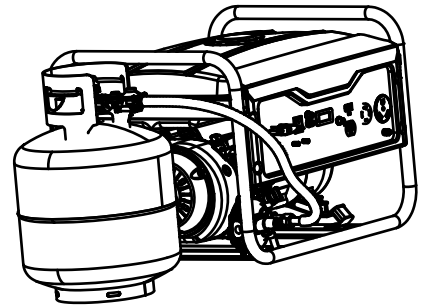

Electric Start Battery Connection

Batteries produce explosive gases. Keep sparks, flames and cigarettes away from battery. To prevent the possibility of creating a spark near the battery, connect charging cables to battery terminals first, then to the generator. When disconnecting, disconnect the cables at the generator first.

1. Connect the red cable with the positive terminal of the battery. Ensure the connection is secured by using the fastener at the battery terminal.
2. Connect the black cable with the negative terminal of the battery. Ensure the connection is secured by using the fastener at the battery terminal.
Be sure to connect the Electric Start Battery to the Dual fuel Generator set before operation. Improper connection will cause malfunction.

Do not reverse the polarity of the terminals when charging the battery. Serious damage to the generator and/or battery may occur. Do not attempt to connect the battery while the generator engine is running. Disconnect the cables from the battery while the generator is in storage.

3. When using gasoline to start the engine, the battery must be properly connected to the generator and check the battery voltage is normal.

Operation

Starting the Generator Set

Ground Terminal

Before using generator, a ground wire must be connected to the ground terminal.

The Ground terminal is located on the Front Panel. Before using the ground terminal consult a qualified electrician.

Ground Terminal Symbol: 

The 7750Watt dual fuel generator can be started using the following method. Recoil Start Method,
Electronic Start Method

IF USING PROPANE FUEL SOURCE

1. Connect the gas pipe to the intake nozzle of regulator;
2. Open the valve of LPG bottle;
3. Turn the fuel selector to “LPG” position;
4. Push the engine switch to “ON” position;
5. Close the choke.
6. Continue to desired start-up method.

IF USING PROPANE FUEL SOURCE

1. The battery must be properly connected to the generator and check the battery voltage is normal.
2. Turn on fuel valve.
3. Close the choke.
4. Push the engine switch to “ON” position
5. Turn the fuel selector to “GAS” position.
6. Continue to desired start-up method.

Operation

RECOIL START METHOD

1. Disconnect all devices from the outlets on the generator panel.
2. Press the engine switch to the "ON" position.
3. Grasp the recoil starter handle and pull it until the engine starts.

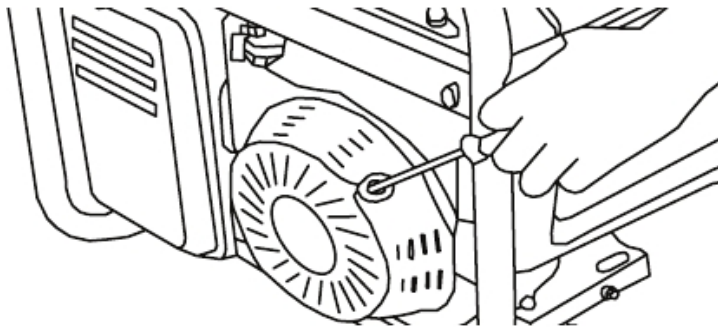

Do not allow the recoil starter to snap back. Return it slowly by hand

4. Push the choke lever to the OPEN position as the engine warms up. The choke is used to provide the proper mixture when the engine is cold.

It can be opened and closed by operating the choke lever manually by starting.

ELECTRIC STARTING METHOD

Batteries produce explosive gases. Keep sparks, flames and cigarettes away from the battery. To prevent the possibility creating sparks near the battery, connect the charging cables to the battery terminals first, then to the generator. When disconnecting, remove cables at generator first.

1. Follow fuel source selection steps.
2. Push the engine ignition button until the generator starts. Do not push the ignition button for more than 5 seconds. Doing so may damage the alternator.

Operation

If electric start does not turn on the generator after three attempts, contact customer support. Repeated attempts could damage the ignition mechanism.

3. Follow steps 6-7 from the Recoil Start Method

Using the Generator Set

1. Turn off the switches of the device before connecting to the generator.
2. Start the generator.
3. Insert the plug of the device into the receptacle based on the voltage requirement of the device.

To stop the engine in an emergency, turn the engine switch "OFF".

In order to maintain generator's performance:

Always connect the generator to the ground terminal to prevent electrical shock.

Add the watt ratings of all the loads that the generator set will be powering at the same time. Make sure that total wattage will not exceed the generator rating.

Using DC Output Terminals

You can use 12V 8.3A DC output to charge automotive batteries. Be sure to monitor the battery charge time.

Over-charge may cause explosion and injury

1. Connect the positive (red) terminal of the battery to the red (positive) terminal the 12V 8.3A DC Output Terminal on the front panel
2. Connect negative(black) terminal of the battery to the black (negative) terminal of the 12V 8.3A DC Output terminal on the front panel (DO NOT REVERSE POLARITY OF CONNECTIONS)
3. Start the generator.

Operation

Stopping the Generator Set

When using gasoline

1. Turn off all the connected devices.
2. Allow the generator set run for a few minutes to cool down.
3. Stop the generator set by pressing and holding the engine switch in the OFF position until the generator set stops.
4. Rotate the fuel valve lever back to the OFF position.

When using LPG

1. Turn off all the connected devices.
2. Allow the generator set run for a few minutes to cool down.
3. Turn off the LPG valve.
4. Push the engine switch to “OFF” position.

Operation

Powering 120 Volt AC Tools and Equipment:

1. Prior to powering tools and equipment, make sure the generator's rated voltage, and amperage capacity (120VAC @ 27 AMPs) is adequate to supply all electrical loads that the unit will power. If powering exceeds the generator's capacity, it may be necessary to group one or more of the tools and/or equipment for connection to a separate generator.



CAUTION: ATTEMPTING TO POWER SENSITIVE ELECTRONIC EQUIPMENT WITHOUT THE USE OF AN APPROVED LINE CONDITIONER MAY CAUSE DAMAGE TO THE EQUIPMENT. PULSAR PRODUCTS INC. IS NOT RESPONSIBLE FOR ANY DIRECT OR INDIRECT DAMAGE CAUSED BY FAILURE TO USE AN APPROVED LINE CONDITIONER.

2. Once the generator is running, simply connect the power cords of 120 volt AC powered tools and equipment into the 120 volt AC dual outlets.



NOTE: THE GENERATOR FEATURES AN AC NON-FUSE CIRCUIT BREAKER TO PROTECT THE AC CIRCUIT IN CASE OF AN OVERLOAD. SHOULD AN OVERLOAD OCCUR, THE BREAKER WILL "TRIP" TO ITS "OFF" POSITION, CAUSING THE GENERATOR TO AUTOMATICALLY SHUT DOWN. IN THIS CASE, REFER TO ABOVE IN THIS POSITION. THEN, RESET THE CIRCUITRY SYSTEM BY TURNING THE CIRCUIT BREAKER TO ITS "ON" POSITION. RESTART THE GENERATOR AND CONTINUE POWERING THE REMAINING TOOLS AND EQUIPMENT.

3. Disconnect all electrical powered tools and equipment from the generator's 120 volt Duplex outlets.
4. After the engine and generator have completely cooled, store generator in safe, clean, dry location (if not already installed).

Operation

Powering 12 Volt DC tools and Equipment:

1. Prior to powering tools and equipment, make sure the generator's rated voltage, and amperage capacity (12VDC) is adequate to supply all electrical loads that the unit will power. If powering exceeds the generator's capacity, it may be necessary to group one or more of the tools and/or equipment for connection to a separate generator.
2. Connect the power cord of a 12 VDC powered tool or equipment to the DC Terminals.



CAUTION: MAKE SURE TO CONNECT THE POSITIVE (+) LEAD OF THE POWER CORD TO THE POSITIVE (+) TERMINAL ON THE GENERATOR, AND CONNECT THE NEGATIVE (-) LEAD OF THE POWER CORD TO THE NEGATIVE (-) TERMINAL ON THE GENERATOR.

3. If using only a 12V volt DC tool or equipment, turn the 120 volt AC If using only a 12V volt DC tool or equipment, turn the 120 volt AC
4. Start and run the engine as described above
5. When finished using the generator, turn the engine power switch to its "OFF" position. Turn the fuel valve to its "OFF" position.
6. Disconnect the electrical powered tools' power cord from the generator's DC terminals.
7. After the engine and generator have completely cooled, store the generator in a safe, clean, dry location (if not already installed in one).

Operation

Spark Plug Service

In order to service the spark plug, you will need a spark plug wrench (commercially available). Recommended spark plugs: NHSP LD F7TC. To ensure proper engine operation, the spark plug must be properly gapped and free of deposits.

1. Remove the spark plug cap.
2. Use a spark plug wrench to remove the spark plug.
3. Visually inspect the spark plug. Discard it if the insulator is cracked or chipped. Clean the spark plug with a wire brush if it is to be reused.
4. Measure the plug gap with a feeler gauge.
5. Check that the spark plug washer is in good condition.
6. Install the spark plug by hand to prevent cross-threading.
7. After the spark plug is seated, tighten with a spark plug wrench to compress the washer.



NOTE: THE SPARK PLUG MUST BE SECURELY TIGHTENED. AN IMPROPERLY TIGHTENED SPARK PLUG CAN BECOME VERY HOT AND COULD DAMAGE THE ENGINE. NEVER USE SPARK PLUGS WHICH HAVE AN IMPROPER HEAT RANGE.

USE ONLY RECOMMENDED SPARK PLUS OR EQUIVALENT.

Inspection, Cleaning, and Maintenance



WARNING! ALWAYS MAKE SURE THE ENGINE POWER SWITCH (2) IS IN ITS “OFF” POSITION. DISCONNECT THE SPARK PLUG WIRE FROM THE ENGINE. AND ALLOW SUFFICIENT TIME FOR THE ENGINE AND GENERATOR TO COMPLETELY COOL BEFORE PERFORMING ANY INSPECTIONS, MAINTENANCE, OR CLEANING.

- Before each use, inspect the generator. Check for:
 - Loose screws
 - Misaligned or binded moving parts
 - Cracked or broken parts
 - Damaged electrical wiring
 - Any other condition that may affect safe operation.
- If an engine problem occurs, have it checked by a qualified service technician before further use. Do not use damaged equipment.
- Before each use, make sure the engine’s oil and gas levels are adequate. If necessary, fill the crankcase until the oil level is even with the oil fill hole and/or fill the fuel tank.
- Before each use, remove all debris with a soft brush, rag, or vacuum.
- Lubricate all moving parts using a premium quality, lightweight machine oil.
- Every 50 hours of use, drain the old engine oil and replace with a high quality SAE 10W-30 grade engine oil.
- Every 300 hours of use, have a qualified, certified technician perform thorough maintenance on the generator and engine.
- For long term storage, either drain fuel into suitable container or add a fuel preservative/ stabilizer (not included) to prevent fuel breakdown.

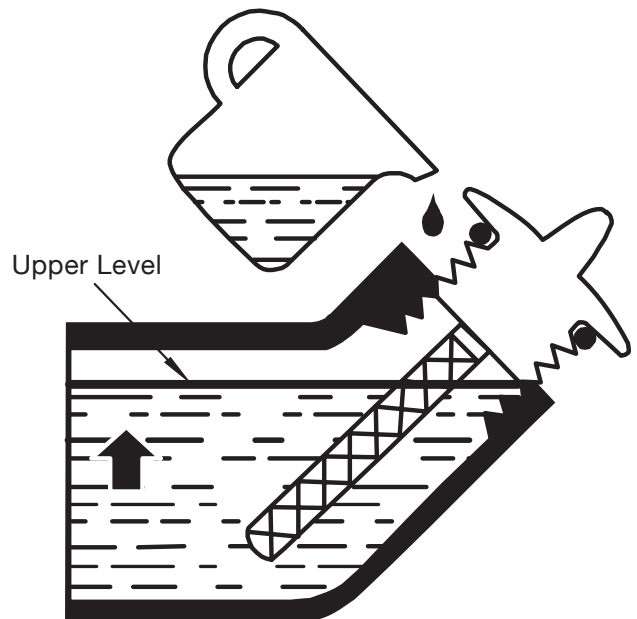

Installation



NOTE: PRIOR TO POWERING TOOLS AND EQUIPMENT MAKE SURE THE GENERATOR'S RATED VOLTAGE, WATTAGE AND AMPERAGE CAPACITY IS ADEQUATE TO SUPPLY ALL ELECTRICAL LOADS THAT THE UNIT WILL POWER. IF POWERING EXCEEDS THE GENERATOR'S CAPACITY, IT MAY BE NECESSARY TO GROUP ONE OR MORE OF THE TOOLS AND/OR EQUIPMENT FOR CONNECTION TO A SEPERATE GENERATOR.

Electrical and other permits may be required for the installation of emergency power systems. Investigate your local building and electrical codes before installing this unit. Installation must be completed by licensed contractors.



WARNING! THE GENERATOR WEIGHS APPROXIMATELY 110 POUNDS. USE CARE AND THE PROPER LIFTING OR HOISTING EQUIPMENT WHEN MOVING IT TO THE INSTALLATION LOCATION. ALWAYS CONNECT HOIST LINES TO THE FRAME OF THE GENERATOR.

General Location

- Make sure to locate and install the generator outdoors where cooling air is readily available.
- Install the generator so that the air inlets and outlets are not blocked by obstructions such as bushes, trees, or snow drifts. Locating it in the path of heavy winds or snowdrifts may require the placement of a barrier for protection. In normal weather conditions, the air vent should face the prevailing wind direction.
- Install the generator on a concrete slab or other area where rain drainage or flood waters can not reach it.
- Generator placement should allow four feet of access to all sides for maintenance.
- Place the generator as close as possible to the electrical tools and equipment being powered to reduce the length of extension cords.

Installation

Supporting and Mounting

Mount the generator on a concrete slab capable of supporting the weight of the generator. The slab must extend on all sides beyond the frame by at least one foot. Contact a cement contractor for slab specifications if necessary. Attach the frame to the concrete slab using 3/8" diameter expansion anchor bolts (not supplied).

Grounding



NOTE: IT IS RECOMMENDED THAT ONLY A TRAINED AND LICENSED ELECTRICIAN PERFORM THIS PROCEDURE

Connect a #6 AWG grounding wire (not included) from the ground connector (8) on the generator to a grounding rod (not included) that has been driven at least 24 inches deep into the earth. The grounding rod must be an earth-driven copper or brass rod (electrode) which can adequately ground the generator.

Troubleshooting

Note: Troubleshooting problems may have similar causes and solutions.

PROBLEM	POSSIBLE CAUSE	SOLUTION
The engine will not start	Is there fuel in the tank?	Refill the fuel tank.
	Is there enough oil in the engine?	Add the recommended oil.
	Is the spark plug in good condition?	Readjust gap and dry the spark plug. Replace it if necessary.
	Is the fuel reaching the carburetor?	Clean the fuel sediment cup.
	When using GAS to start the generator. Checking the battery voltage is normal or not and be properly connected to the generator.	If voltage is abnormal, replace the battery with normal voltage.
No electricity at the AC outlets	Is the AC circuit breaker ON?	Turn the AC circuit breaker ON.
	Check the electrical appliance or equipment for any defects.	<ul style="list-style-type: none"> • Replace the electrical appliance or equipment. • Take the electrical appliance or equipment to an electrical shop for repair.

If the engine still does not start, take the generator to an authorized agent generator dealer.

Specifications

Model	PG1000B	
	GAS	LPG
Max.Power	10kW	9kW
Rated Power	8kW	7kW
AC output		
Frequency	60Hz	
Voltage	120V / 240V	
Power Factor	1.0	
Engine		
Model	DHLG420	
Type	4 Strokes / Air Cooling / Single Cylinder / OHV/ Horizontal Shaft	
Displacement(cc)	420	
Ignition Mode	Transistorized Magneto	
Starting Mode	Recoil / Electric Start	
Fuel Tank Capacity (L / Gal)	25 (6.5)	
Oil Capacity (L / Gal)	1.1 (0.29)	
Continuous Work Time (h) /50% Load	8@GAS	

Wiring Diagram

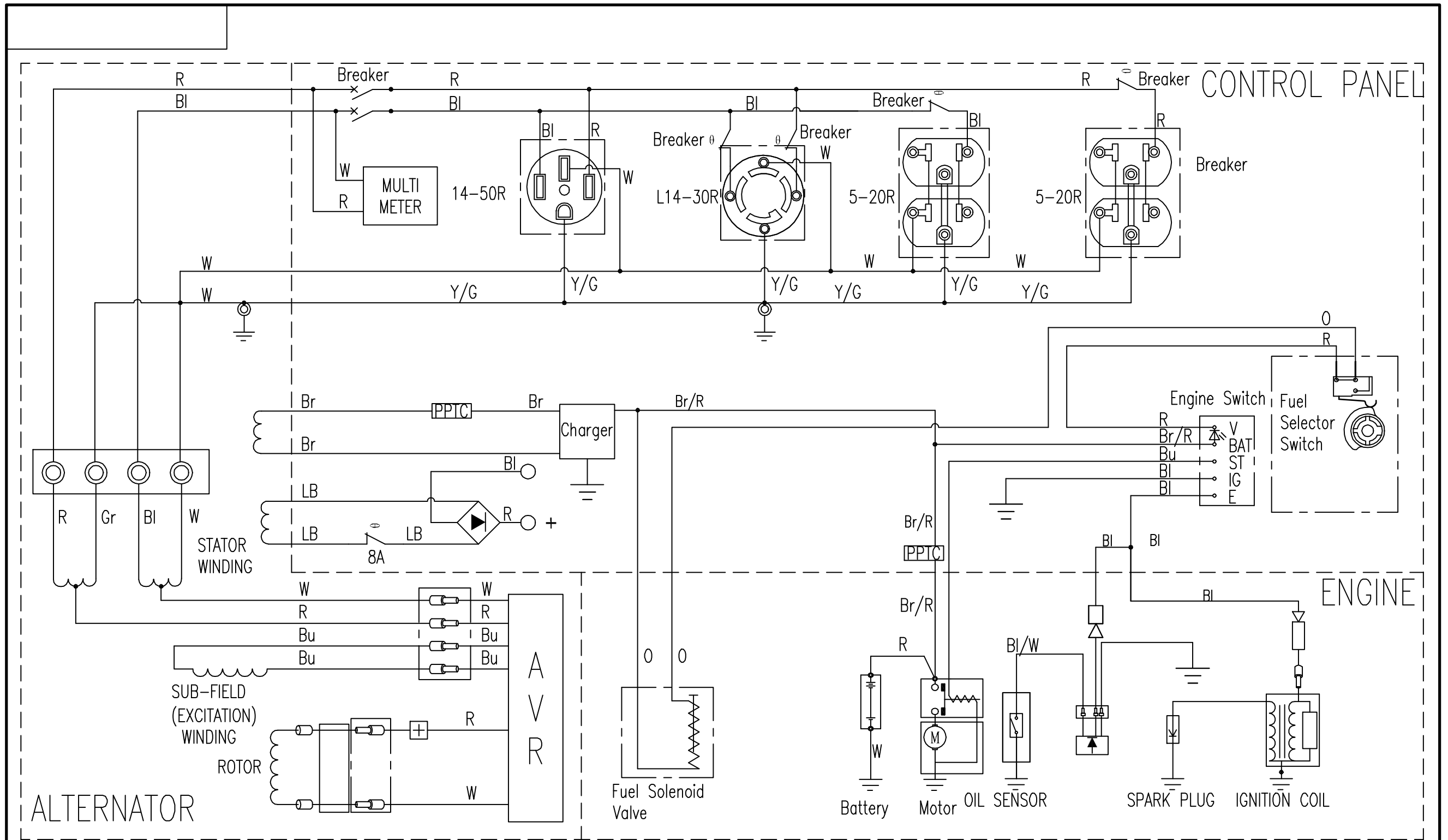

Bl	Black	Br	Brown	Y/G	Yellow/Green
O	Orange	Br/R	Brown/Red	Bl/W	Black/White
Bu	Blue	LB	Light Blue	G	Green
Gr	Gray	Bl	Black	P	Pink
R	Red	W	White		

Engine Switch Connecting

	E	IG	V	BAT	ST
OFF	●	○	○	○	○
ON	○	●	○	○	○
Start	○	○	○	●	●

WIRING DIAGRAM OF 120/240V GENERATOR SET