



# 1000 Watt Puresine Solar Power Generator

## User Manual



**WARNING:** Read carefully and understand all assembly and operation instructions before operating. Failure to follow the safety rules and other basic safety precautions may result in serious personal injury.

Item # 41000

SAVE THESE INSTRUCTIONS

## Important Safety Information

Thank you for choosing a Nature Power Product.

Save the receipt and these instructions. It is important that you read the entire manual to become familiar with this product before you begin using it.

This product is designed for certain applications only, the distributor cannot be responsible for issues arising from modification. We strongly recommend this product not be modified and/or used for any application other than that for which it was designed. If you have any question relative to a particular application.

For technical question please call 1800-588-0590 "or [cs@rdkproducts.com](mailto:cs@rdkproducts.com)"

### WARNING

- Read and understand all instructions. Failure to follow all instructions may result in serious injury or property damage.
- The warnings, cautions, and instructions in this manual cannot cover all possible conditions or situations that could occur. Exercise common sense and caution when using this product. Always be aware of the environment and ensure that the product is used in a safe and responsible manner.
- Do not allow persons to operate or assemble the product until they have read this manual and have developed a thorough understanding of how it works.
- Do not modify this product in any way. Unauthorized modification may impair the function and/or safety and could affect the life of the product. There are specific applications for which the product was designed.
- Industrial or commercial applications must follow OSHA requirements.



#### **WARNING**

This product can expose you to chemicals, including Di (2-ethylhexyl) phthalate (DEHP) which is known to the State of California to cause cancer, birth defects or other reproductive harm. For more information, go to [www.p65warnings.ca.gov](http://www.p65warnings.ca.gov)



#### **ADVERTENCIA**









Este producto puede exponerlo a productos químicos, incluidos Di (2-etilhexil) ftalato (DEHP) que el estado de California sabe que causa cáncer, defectos de nacimiento u otros daños reproductivos. Para obtener más información, vaya a [www.p65warnings.ca.gov](http://www.p65warnings.ca.gov)

## Caution

- This product has a built-in high-voltage power supply and battery. keep away from children.
- For long-term storage (more than one month), please charge the power generator to about 70%.
- Do not place the unit close to or in a fire or expose it to heat. Keep out of direct sunlight.
- Do not use in damp environment, do not knock or hit the product.
- Please charge with the original charger or according to the charger in accordance with the electrical parameters specified by the manufacturer.
- Please charge the power generator within the temperature range of 0 ~ 45°C. Charging at too low or too high temperature will shorten the life of the battery.
- In the case of long-term storage (more than 3 months), it should be stored in a semi-electric state in a low humidity environment without corrosive gas at a temperature of -10 ~ 35°C.
- If the power generator emits peculiar smell, high heat, smoke and other abnormal conditions during charging, using or storage, please stop charging immediately, and place it in an open place for remote observation, after confirmation of safety, contact the manufacturer or dealer.
- Precautions when working with solar panels

With the incidence of sunlight or other light sources on all solar panels, a voltage appears at the output terminals of the solar panel turning it into a source of electricity. To avoid a shock hazard make sure the solar panel is covered with an opaque (dark) material such as paper/cloth during the installation. Do not make contact with the terminals when the panel is exposed to sunlight or other light sources.

## Features

								
PURE SINEWAVE	ADVANCED CHARGING EFFICIENCY	BMS PROTECTION	-10~50°C (14~122°F)	HIGH POWER SOLAR CHARGING	FAST CHARGER	1000 LIFECYCLES	RoHS CE FCC	TECHNICAL SUPPORT

## Intended Use

This power generator is a portable multifunctional energy storage power supply, with a built-in lithium-ion battery, a safe lithium battery management system (BMS), and a high-efficiency energy conversion circuit. It is wrapped by a high-strength composite resin body shell. Light weight, small size, high power, etc., providing customers with convenient mobile energy. power generator can meet the power supply needs of most household appliances, such as rice cookers, small refrigerators, speakers, televisions, mobile phones, computers, cameras, camcorders, tablets, LED lights, emergency lights, drones, power tools, Medical equipment, etc. Contains a wide range of application areas, such as rescue and disaster relief, emergency rescue, first aid, outdoor exploration, outdoor construction, outdoor live broadcast, camping and solar power.

## Parts List

	Reference	41000
1	Power generator	1
2	AC Charger	1
3	10W Semiflex solar panel	1
4	Manual	1
5	DC Socket - SAE cable	1
6	Cigarette plug cable	1
7	SAE - Bare end cable	1

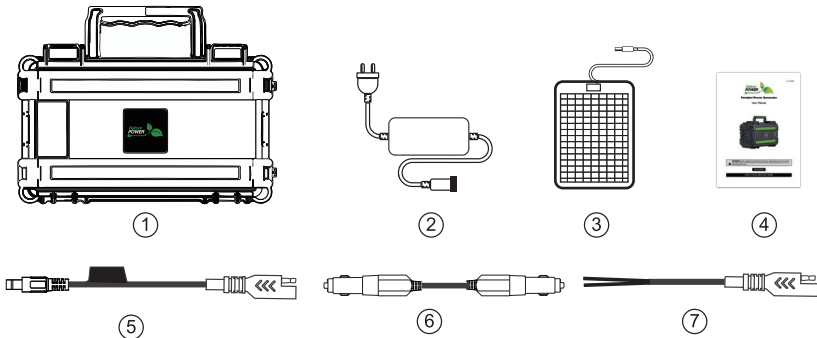

## Product Function

Item # 41000

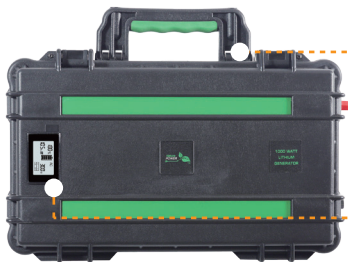

HANDLE

LCD DISPLAY



DC POWER SWITCH

AC POWER SWITCH  
(Main power switch for AC & DC)

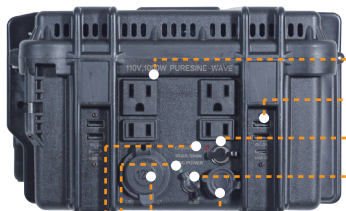

4X 110V AC OUTPUT

USB / USB-C OUTPUT

SOLAR IN, 120W MAX

DC5525 OUT

AC IN

CAR CHARGE IN / 12V,10A OUT

DC POWER INDICATOR LIGHT

CHARGING INDICATOR LIGHT  
(For solar charging only)

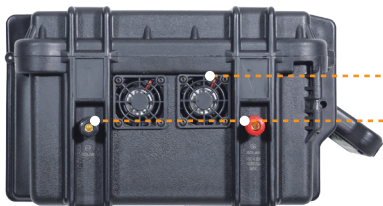

COOLING FAN

SOLAR INPUT

## LCD Display

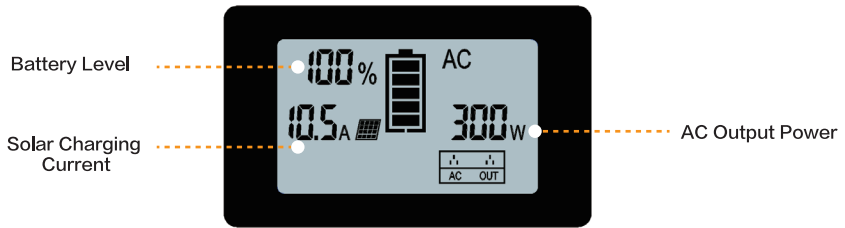

## Charging

The power generator has a charging protection function and is used in accordance with normal charging operations. After the power generator is fully charged, it will automatically stop charging. If you need to use it while charging, the output power should be less than 100W, and it will be fully charged according to the internal battery capacity. If the output power is more than 100W, the power generator will slowly drain the battery power. Can be used normally after the load is disconnected and fully charged.

The power generator is equipped with 4 charging ports.

### 1. AC Charging

Charger's indicator light turns to green while charging.

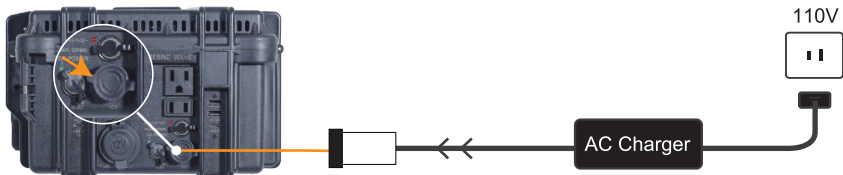

### 2. Vehicle Charging

Make sure the vehicle's engine is running, Please disconnect after fully charge.

**Important notice:**

- 1, DC Power switch need to be "ON" when charging by vehicle.
- 2, Make sure the cigarette plug from vehicle is 12 volt, otherwise do not charge.

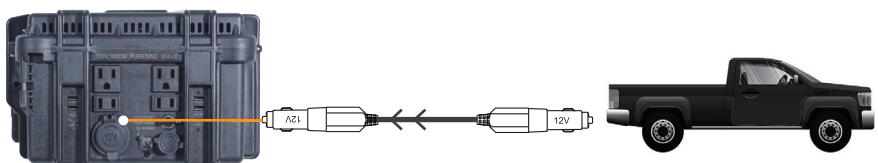

### 3. Solar Charging

#### 3.1 Solar panel power less than 120W

1. The included 10W Semiflex solar panels coming with DC socket connector can directly connect to the solar port for charging, the other solar panels with DC socket connector and less than 120W can be the same.

2. If solar panel coming with a SAE connector and less than 120W, the included SAE-DC socket cable can be use to connecting power generator for charge.

**Noted: Note: LCD display will show zero charging current when solar input is under 0.5A DC Power switch doesn't need to be "ON" when charging by solar.**

#### Important notice:

Your solar panel SAE output terminals, either directly from the solar panel or via the Charge Controller are always Female Positive Polarity. If you are not clear on the SAE connector polarity, please check using a multimeter or consult with the seller.

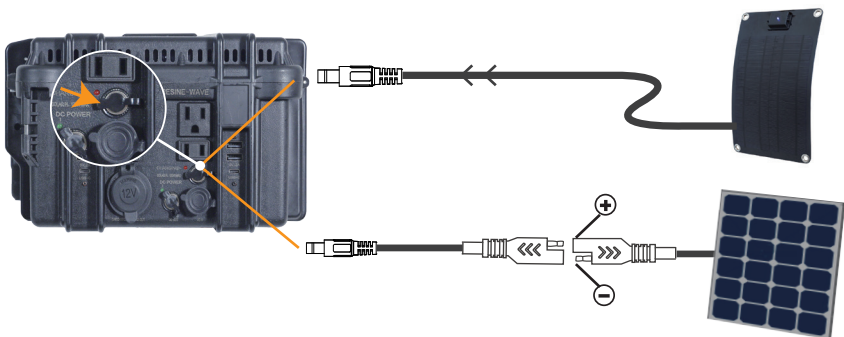

#### 3.2 Solar panel power higher than 120W

Solar panels power higher than 120W requires the bare end connector to charge. This bare end connector charging current can be up to 20A and about 400W maximum solar power.

#### Important notice:

Please monitor the charging current on LCD display when charging with the high power solar kit, Charging current exceed 20A will activated BMS protection and power generator will shut down.

Your solar panel SAE output terminals, either directly from the solar panel, or via the Charge Controller, are always Female Positive Polarity. If you are not clear on the SAE connector polarity, please check using a multimeter or consult with the seller.

Charge controller is not required.

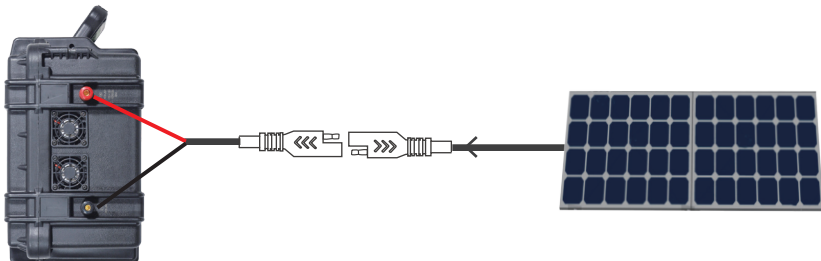

## Output

This power generator is designed with 3 areas function outputs, namely AC area, DC area, and USB area.

### 1, AC Output

Turn on the AC power switch and the LCD will light up. The buzzer will beep for about 2 seconds. The fan will run 3 seconds at the same time, AC and DC output will be ready.

### 2, DC Output

Turn on DC power switch, output ports are:

Cigarette port, Maximum 120W output.









DC5525 port (DC5525 is not controlled by the DC power switch, Same port as AC IN), Maximum 60W output.

### 3, USB / Type-C Output

Turn on the DC power switch, Please turn it off in time after charging.

### 4, Powered Devices

Common Devices for each charging port

AC Output	DC Output	USB / USB-C Output
 Work light (100W) Approximately 18 Hours	 Portable Fridge (60W) Approximately 36 Hours	 Ipad (25W) Approximately 48 Charges
 Fan (60W) Approximately 32 Hours	 Drone (90W) Approximately 20 Hours	 Motion camera (5W) Approximately 220 Charges
 Laptop (30W) Approximately 64 Hours	 Light (30W) Approximately 48 Hours	 Smartphone (18W) Approximately 120 Charges



## Specification

Model		41000	
Battery	Battery	Lithium ion Battery	
	Power	1000W Rate / 2000W Peak	
	Capacity	2200WH	
	Voltage	12.6V Max	
	Lifecycle	1000 Times	
	BMS Protection	Over current / over Charge / over discharge / Short Circuit Protection	
AC Output	AC Charging Input Voltage	110V	
	Output Frequency	60HZ	
	Output Waveform	Puresine Wave	
	Efficiency	70% load > 90% (the lower the load power, the higher the discharge efficiency)	
	Output Power		AC100W≈1080min
			AC300W≈320min
			AC500W≈200min
		AC800W≈120min	
		AC1000W≈60min	
DC Output	DC5525	DC12V / 5A	
	Cigarette Socket	DC12V / 10A	
	Efficiency	70% load > 90% (the lower the load power, the higher the discharge efficiency)	
	USB	5V / 2A	
	USB-C	5V / 2A	
Charge	AC Charging	12.6V / 10A ≈ 21 hours	
	AC Charging Input Voltage	110V	
	Solar Charging	18V / 10A ≈ 22 hours	
	Solar Charging Input Voltage	18-24V	
	Vehicle Charging	12V / 8A ≈ 22 hours	
	Vehicle Charging Input Voltage	12V	
Operating Temperature	Charger Temperature	0~40°C ( 32~104°F )	
	Discharge Temperature	-10~50°C ( 14~122°F )	
	Storage Temperature	-10~45°C ( 14~113°F )	

## FAQ

### **What happen if the AC output overloads?**

A beep will sound and then the power generator will be turned off. After removing some electrical appliances, the power generator can be turned on again for normal use.

### **Does the power generator need to be turned on for charging?**

Please Switch the DC POWER to "ON" position when charging by vehicle. the other charging do not need to turn on the power generator. When using high-power solar charging, it is necessary to switch on to monitor the charging current, charging current can not exceed 20A.

### **Does the power generator require an external charge controller?**

No, there is a MPPT build in charge controller

### **Can the battery in the power generator be replaced?**

Cannot be opened internally and the battery cannot be replaced

### **Is it possible to charging by vehicle and solar at the same time?**

Yes.

### **Can power generator discharge (output use) while charging?**

This power generator supports charge and discharge at the same time, when the output power is greater than the input power, the battery power reducing slowly, when it is reduced to a low power state, the output will be turned off.

### **Does this power generator have temperature protection?**

When it is used in a high temperature environment, if the internal temperature higher than 50 C , the circuit will be turned off for battery protection.

### **Why are there 2 solar charging ports?**

The diversified input connection design allows users to use the high-power or low-power solar panels nearby to charge the device anytime and anywhere.

### **How much power can be charged by the solar panel, what will happen if the power is exceeded?**

The power generator has 2 solar charging input ports, DC5521 supports a maximum input of 120W, solar panels above 120W will not be configured DC5521 socket, the DC5521 input port must not exceed the specified power.

The bare end input can support solar panels with VOC (Open Circuit Voltage) less than 26V. The total current should be less than 20A. If it exceeds that then the battery protection will be activated in a very short time and shutdown without warning sounds, and you will need to lower the input power and restart.

## Trouble Shooting

### **Power generator will not turn on, no output**

Remove the product load, charge for 5-10 minutes and reboot.

Please ensure the power generator is in normal temperature range.

### **Power generator will turn on, but has no output**

Low battery, charge in time.

Check the rated power of electrical appliances, higher than the generator peak power will cause protection, remove the load, and restart.

Use the electrical device on other power sources to check if it in normal use. Some devices may not be compatible.

### **Accidental shutdown during product use**

This power generator has a built in real time safety monitoring system which may cause unit to shut down because of the internal protection system startup. This will protect from overcharging, over discharge, high temperature, over current, overload, and short circuit. In order to solve the problem quickly, remove all electrical equipment, keep the power generator temperature in normal range and charge for 5-10 minutes. Also check the electrical device for failure.

### **Power generator can not be recharged**

Vehicle charging - Check the fuse of charging cable

Solar charging - Check the solar current and voltage, Voc should less than 26V and under 20A.

## Limited Warranty

Nature Power warrants solar generator to the original purchaser that is free from defects in materials and workmanship for the period of 2 year from date of purchase, 1 year on accessories. In the case of product defect, contact Nature Power customer service to receive trouble shooting. If defective part or unit should be returned, a Return Authorization Number must be issued by Nature Power and the defective part or unit should be returned to the authorized location at the purchasers' expense. A dated proof of purchase is required to receive warranty service. Once received at authorized location and defect proves to be the result of defective material and workmanship, the defective part or unit will be replaced at warrantors' option and returned to the original purchaser at warrantors' expense. No refunds will be granted by the warrantor, in the event of buyer's remorse please contact your point of purchase within and in adherence to their return policy. Refunds are granted at the retailers' discretions.



Please contact Nature Power Products to acquire more information:

1-800-588-0590

[info@naturepowerproducts.com](mailto:info@naturepowerproducts.com)

[www.naturepowerproducts.com](http://www.naturepowerproducts.com)

Made in China

Page 12 of 12