

G70

**DISCOVER
WHAT'S
POSSIBLE**

FULL USER INSTRUCTIONS



DISCOVER WHAT'S POSSIBLE

Welcome to braver brewing. We've stepped up our game to bring you the perfect half barrel, Smart Brewing System. The Grainfather G70 has wireless brew session control. Use it with our App for a connected experience and monitor your brew wherever you go.

Before you start pushing brewing boundaries, we recommend reading the instructions and safety notes.

 **FOR THE BRAVE**



CONTENTS

Safety information

Important Warnings	4
Safety Instructions	4

Identification of parts

Parts List	6
------------	---

Assembly

Pre-Brewing Assembly	9
Connecting the Controller and Power	9

Wireless control

Connecting the Controller to the Mobile App	11
---	----

Brewing

Setting up to Brew and Mashing	15
Sparging	17
Boiling	18
Cleaning	19



Know what you're looking for?

Click on the page number or use the PDF bookmarks to navigate to it.

SAFETY INFORMATION



Please note that a **two-person or mechanical lift** is required when using this system. The Grain Basket can weigh up to **60kg (132lbs)** when in use and a single person lift may lead to **serious injury**.

IMPORTANT WARNINGS

- This brewing system requires a dedicated, professionally installed power socket of 220V - 240V 15 Amps.
- The G70 Body, lid and pipes reach temperatures up to 100°C (212°F) and therefore must be handled with caution.
- Never move the unit while it is in operation or containing hot liquid. This could lead to injury or scalding.
- Handles on the side are only meant for transportation once the Grainfather is empty and in a cooled, non-use state.
- When liquid is frozen in the Appliance, do not turn the Appliance on. Please pour hot water into the G70 Body to defrost the inside of it before turning it on.

SAFETY INSTRUCTIONS

- Read all instructions before using the Grainfather G70.
- For full cleaning instructions please refer to the cleaning section in this guide.
- If the supply cord is damaged, it must be replaced by the manufacturer, its service agent or similarly qualified persons in order to avoid a hazard.
- This Appliance is intended to be used in household and similar Applications such as staff kitchen areas in shops, offices and other working environments; farm houses and by clients in hotels, motels and other residential type environments; bed and breakfast type environments; catering and similar non-retailed Applications.
- The Appliance is for indoor use only.
- The Appliance is not suitable for installation in an area where a water jet could be used.
- The Appliance must not be cleaned by a water jet.
- The Appliance must be placed on a flat surface.
- The Appliance is only to be installed in locations where it can be overseen by trained personnel.
- The installation of a residual current device (RCD) having a rated residual operating current not exceeding 30 mA is advisable.
- The A-weighted sound pressure level of the Appliance is below 70 dB.
- Always unplug the unit before cleaning, during storage or in the event of a fault.
- To protect against fire, electric shock and injury, do not immerse cord/plugs in water or other liquid.
- The G70 body, lid and pipes reach temperatures up to 100°C (212°F) and therefore must be handled with caution.
- Never move the unit while it is in operation.
- Handles on the side are only meant for transportation once the Grainfather is empty and in a cooled, non-use state.
- Two-person or mechanical lift required for lifting the sparge basket. Basket can weigh up to 60 kg (132 lbs) during use. Please do not attempt single person lift.
- Access of the service area is restricted to persons having knowledge and practical experience of the Appliance.
- The maximum and minimum ambient temperatures for normal use of the Appliance is: -20°C (-4°F) to 40°C (104°F).
- The Appliance is only for heating water and wort. Do not use the Appliance to heat any other type of liquid. Please clean the Appliance before and after use, following the instructions in this guide.
- Save these instructions for future reference.

The following statement Applies to the Grainfather G70 product sold in Europe:

- This Appliance can be used by children aged from 8 years and above and persons with reduced physical, sensory or mental capabilities or lack of experience and knowledge if they have been given supervision or instruction concerning use of the Appliance in a safe way and understand the hazards involved.
- Children shall not play with the Appliance. Cleaning and user maintenance shall not be made by children without supervision.

The following statement Applies to the Grainfather G70 product sold in the United Kingdom:

- This Appliance can be used by children aged from 8 years and above and persons with reduced physical, sensory or mental capabilities or lack of experience and knowledge if they have been given supervision or instruction concerning use of the Appliance in a safe way and understand the hazards involved. Children shall not play with the Appliance. Cleaning and user maintenance shall not be made by children without supervision.
- Means for disconnection must be incorporated in the fixed wiring in accordance with the wiring rules.
- The fixed wiring insulation must be protected, for example, by insulating sleeving having an Appropriate temperature rating.

The following statement Applies to the Grainfather G70 product sold in Australia and New Zealand:

- This Appliance is not intended for use by persons (including children) with reduced physical, sensory or mental capabilities, or lack of experience and knowledge, unless they have been given supervision or instruction concerning use of the Appliance by a person responsible for their safety.
- Children should be supervised to ensure that they do not play with the Appliance.



IDENTIFICATION OF PARTS

PARTS LIST

1. G70 Body
2. Sight Glass Cap
3. Sight Glass Seal Top
4. Sight Glass
5. Controller
6. Stainless Steel Sight Glass Sheath
7. Sight Glass Seal Bottom
8. Sight Glass Elbow
9. Ball Valve / Sight Glass Elbow O-ring
10. Sight glass / Recirculation Retention Nut
11. Support Ring
12. Support Ring Retainer
13. Recirculation Hose Barb Holder
14. Recirculation Elbow
15. Recirculation Pipe Seal
16. 1/2" Ball Valve
17. Stainless Steel Recirculation Pipe
18. Hop Filter
19. Pump
20. 1/2" Tee Body Connection
21. 1/2" Tee Connection Nut
22. Tee Section Flat Washer
23. 1/2" Tee
24. Tap O-ring
25. 1/2" Tap
26. 1/2" Hose Barb
27. Overflow Inlet
28. Top Grain Plate
29. Grain Stopper
30. Top Overflow Pipe
31. Grain Basket
32. Bottom Overflow Pipe
33. Bottom Grain Plate
34. Overflow Nut
35. Dust Cover
36. Glass Lid
37. Lifting Bar
38. Counterflow Wort Chiller
39. Recirculation Hose and Barb
40. Power Cable
41. Sight Glass Cleaning Barb
42. Sight Glass Blank Hex Cap
43. Post Boil Cleaning Filter
44. Tap Adapter Set



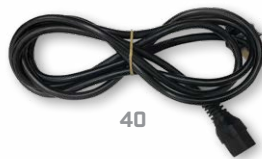
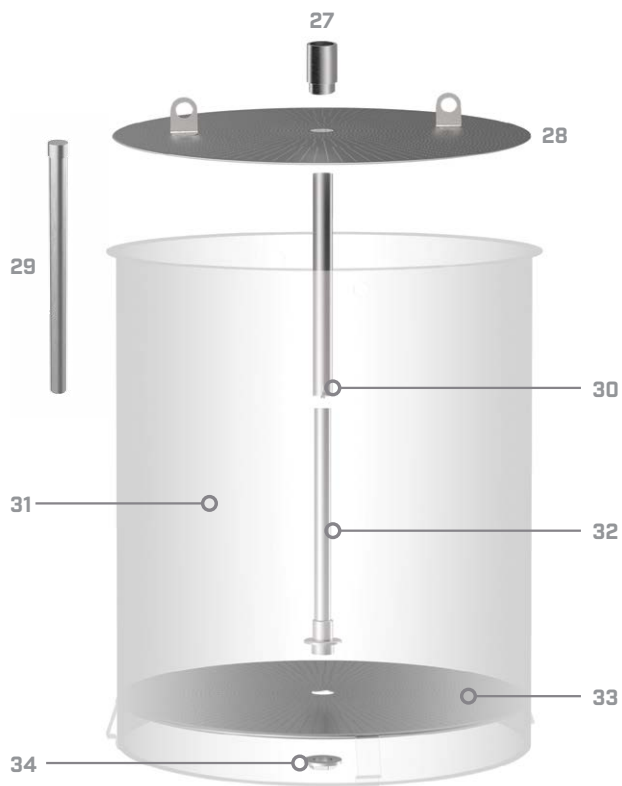

ASSEMBLY

Please follow these assembly instructions carefully to ensure you have a great brewing experience on the G70. Make sure to familiarise yourself with the [Parts List](#).



PRE-BREWING ASSEMBLY

We recommend that you clean your G70 before the first use. Refer to step C of the [Cleaning Section](#) of this guide for instructions.

1. Install the Hop Filter

Take the Hop Filter (18) and place it on the inside base of the G70 Body (Fig A). It should fit tightly. Apply pressure to make sure it's securely in place.

NOTE: It is important to install the Hop Filter before brewing. Brewing without the Hop Filter may allow material to block the pump.



CONNECTING THE CONTROLLER AND POWER

2. Attaching the Controller

Take the Grainfather Controller (5) and place it securely on the front bracket (Fig B). Next remove the small cap from the M12 socket located at the front lower section of the G70 Body and plug the M12 cable into the socket. Finally, tighten the securing nut (Fig C).



3. Connect power

Take the Power Cable (40) and plug it into the socket inlet at the back of the G70 Body. Next plug the other end of the cable into the professionally installed 220V - 240V 15A (13A in UK) power socket. Turn on the master switch at the base of the G70 Body. The controller should now receive power and the display will turn on. If this does not occur, please check both the M12 controller cable and the main power cable are securely connected.

4. Advanced wireless connection and App control

At this point you will be able to manually control the features of the Grainfather G70 using the Controller. Remember, the G70 is designed with smart features, wireless connectivity and access to the Grainfather Brewing Community which are all accessible after setting the Controller up on your local wireless network.

WIRELESS CONTROL

Get a seamless brewing experience with the G70 Wireless Controller. Use it in manual mode or connect the controller to the Grainfather App via your Android or iOS device to manage and monitor your brew session wherever you are. Program 1000's of recipes from the community or your own signature brews directly into your controller.



CONNECTING THE CONTROLLER TO THE MOBILE APP

Setting up the Wireless Controller:

Step 1

Make sure your wireless network is active in the space you will be using your Grainfather G70. Although a wireless connection can be made over long distances, as a rough guide place the G70 unit within 10m (30 ft.) of the wireless source or use a wireless range extender/repeater to allow you to place the G70 unit further away.

Step 2

Download the Grainfather Community Mobile App onto your mobile device from the App Store or Google Play Store (or scan the QR code to take you there) and register an account if you have not already done so.



Step 3

When you first start up the Controller, you will be greeted with the Connection Setup screen (Fig D). If you do not see this screen, then you can press the 'Set' button on the Controller and go to Network Config > Add New Network. Once in the Connection Setup screen you will need to open the Grainfather Community App on your mobile device.



FIG D:

Step 4

Once in the App, navigate to the Equipment screen (Fig E-1). The Equipment screen shows all the brewing and fermenting equipment you have set up on your account. The following screen layouts depict an iOS device and may differ slightly for Android.

To add a new device, tap on the + icon on the bottom right of the screen and select Brewing Equipment.

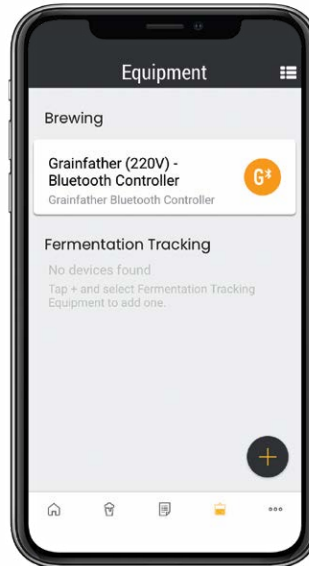

FIG E-1

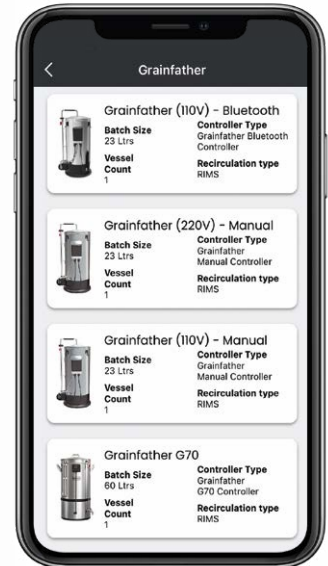

FIG E-2

Select Grainfather on the list of brands and subsequently select Grainfather G70 on the list of equipment (Fig E-2). On the Device Setup screen tap the 'ready' button (Fig E-3).

Your mobile device may now request certain permission(s) required to connect with the G70 and may vary for different devices. Accept all requests.

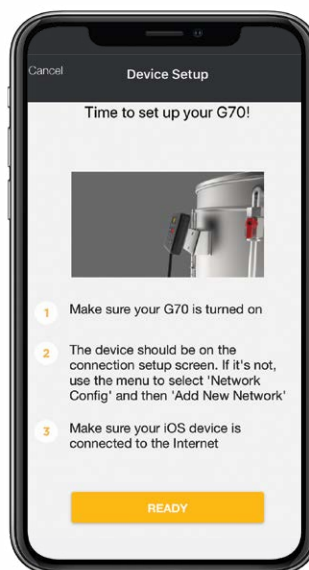

FIG E-3



FIG F

Step 5 (Android)

If setting up using an Android mobile device: Choose your G70 Controller (Fig F).

Step 5 (IOS)

If setting up using an iOS mobile device: Following the instructions on the screen (Fig G-1), connect your mobile device to the G70. Once the connection is established you should receive a notification on your mobile device (Fig G-3).

Once connected, return to the Grainfather Community App. You should be returned to the Device Setup screen to select your wireless network to connect your G70 to (Fig H-1).

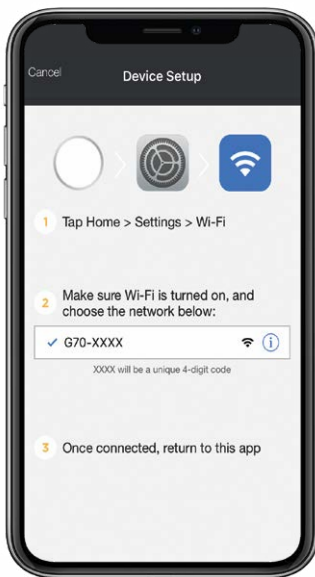

FIG G-1

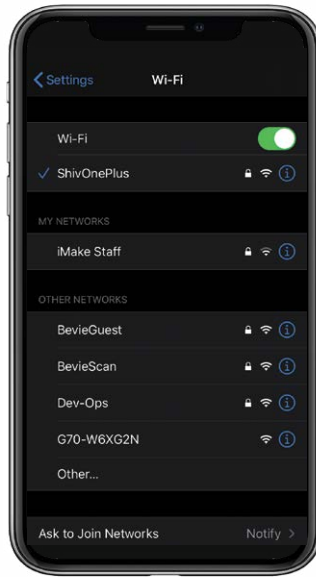

FIG G-2

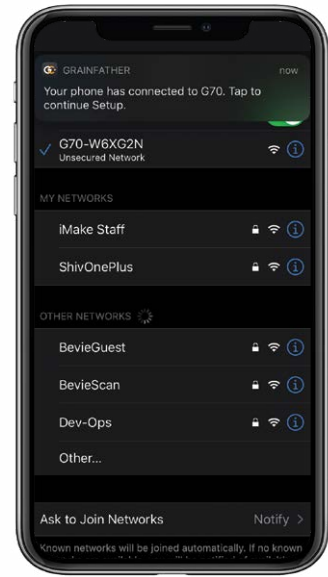

FIG G-3

Step 6

Select your wireless network and enter in your network credentials and tap the 'Connect' button. Once connected you should be presented with the following screen (Fig H-3). Write a name for your new device and tap the 'done' button.



FIG H-1



FIG H-2

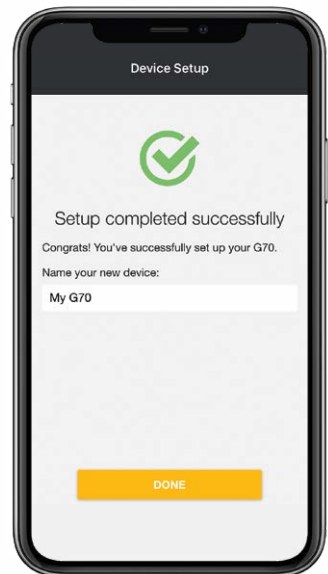

FIG H-3

Step 7

Setup is now finished, and you will be returned to the Equipment screen (Fig I). Select your newly connected Grainfather G70 Controller to enter the controller interface.

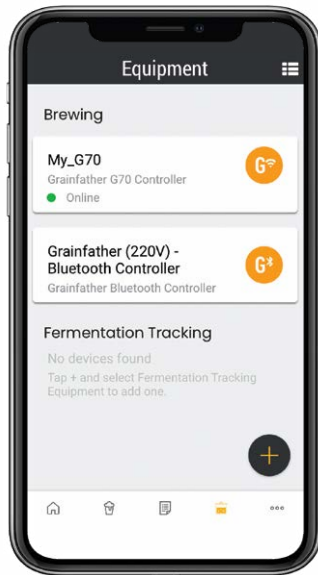

FIG I

Lastly you will be prompted to grant permission on the G70 Controller to be controlled remotely (Fig J). Select 'Yes' on the controller. The G70 is now ready for you to start controlling your brew session.



FIG J

NOTE: This permission request for remote control is in accordance with IEC/EN 60335-1 and will appear each time you connect to the G70 via a mobile device.

A MORE CONNECTED BREWING EXPERIENCE

Download the Grainfather App and take your brewing tools, calculators and recipes wherever you go.

- Brew 1000's of community recipes
- Create your own signature brews with the advanced recipe creator
- Make quick and accurate advanced brewing calculations without leaving the app
- Connect fermentation tracking devices like Tilt, Plauto and iSpindel to easily track and record your brew data in one place
- Monitor your brew session remotely with alerts and notifications
- Available to download from the Apple App Store or Google Play Store

With the G70 you can use your mobile device as a remote control to monitor your brew wirelessly. Automate mash schedules and multitask without losing any of the hands-on brewing fun.

DOWNLOAD THE APP



BREWING

Once you've assembled your unit, it's time to start brewing beer. Follow these steps to get familiar with the brewing process on the G70. Begin brewing enough beer to share or bring authenticity back with 1/2 barrel pilot batches.



SETTING UP TO BREW, AND MASHING

1. Preparation, adding water

After all the steps above have been completed you are ready to start a brew. Based on your recipe, calculate the required amount of mash water then add it to the G70. Water volumes and salts can be calculated using the advanced calculators available on the Grainfather Community Platform.

NOTE: Make sure your G70 is on a stable flat surface and that the 1/2" tap (25) is closed before you start.

2. Priming the pump

Open the 1/2" Ball Valve (16) on the Stainless Steel Recirculation Pipe and turn the pump on to circulate water through the pump. If no flow occurs, turn the pump off, wait 1 minute, and turn the pump back on. If no flow occurs after a second attempt, close the 1/2" Ball Valve, place a container under the opening of the 1/2" Tap (25), turn the pump on and fully open the 1/2" Tap to help clear any air trapped in the system.

3. Set the mash/strike temperature

Using the Controller set the required mash temperature using the ▲ ▼ buttons and press the 'Heat' button to initiate heating. Place the lid on the unit to speed up the heating time. You can also use the Grainfather Community App to connect to the Controller and run your brew session remotely on your device.

4. Assemble the Bottom Grain Basket components

Take the Bottom Grain Plate (33) with the rolled edge facing down, insert the Bottom Overflow Pipe (32) onto the top of the Bottom Grain Plate. Next, screw the Overflow Nut (34) onto the bottom to secure the Bottom Grain plate to the Bottom Overflow Pipe as shown in Fig K.

5. Bottom Grain Plate and Overflow Pipework

Insert the newly assembled bottom components from step 4 into the Grain Basket (31), making sure you have assembled them so that the Bottom Grain Plate (33) has its rolled edge facing down. Take the Top Overflow Pipe (30) and insert this onto the top of the Bottom Overflow Pipe (32) so that there is no more than an inch of overlap. Make sure the wire springs are facing down. Insert the Grain Stopper (29) into the top of the Top Overflow Pipe. The Grain Stopper has a cap on its top end which should sit on the top edge of the Top Overflow Pipe.

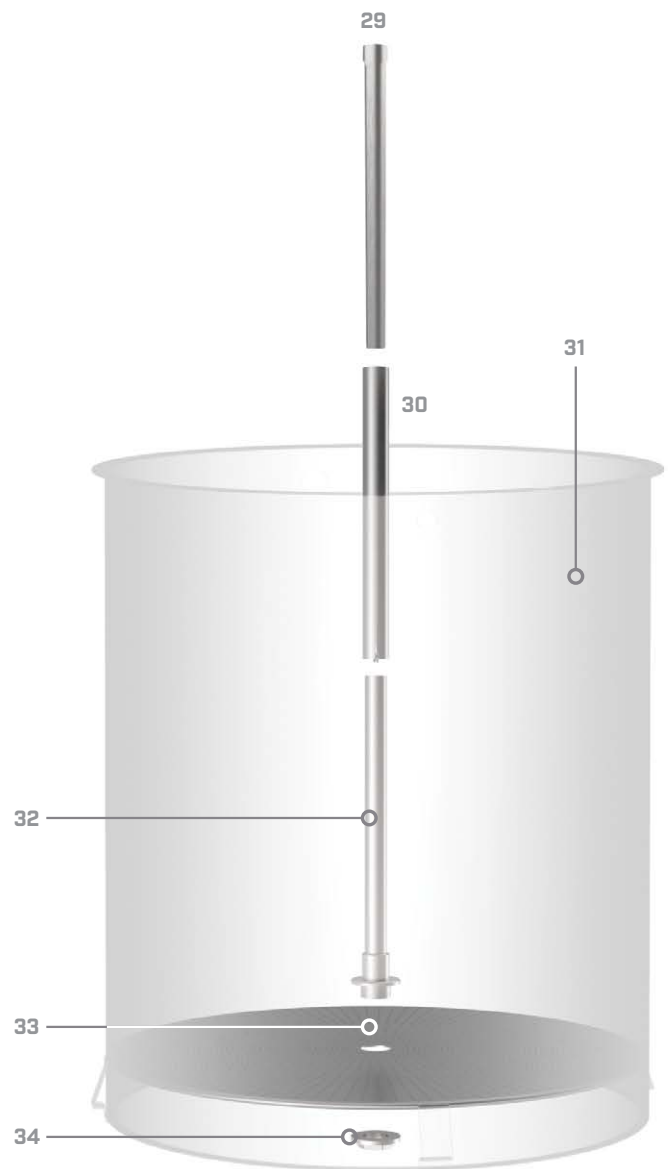

FIG K

6. Add Grain Basket and Overflow Pipework

Slowly insert the assembled Grain Basket into the G70 Body as shown in Fig L, making sure that the Top Overflow Pipe (30) is fully extended.

TIP: Use the Lifting Bar (37) to make inserting the Grain Basket easier.



FIG L

7. Add grains and stir

Once mash/strike temperature is reached slowly add the grain to the Grain Basket (31), stirring well to avoid any dry clumps.

8. Install Top Grain Plate and Overflow Inlet

Fit the Top Grain Plate (28), resting it on top of the grain bed. Make sure it is level. Next, remove the Grain Stopper (29) and fit the Overflow Inlet (27) onto the Top Overflow Pipe (30), press down until it fits into the hole of the Top Grain Plate – but do not press too hard.



FIG M

9. Install the Recirculation Hose and Barb

Locate the Recirculation Hose and Barb (39). Make sure the hose is securely attached to the Recirculation Barb and push fit the Recirculation Hose and Barb into the recirculation opening on the inside of the G70 body as shown in Fig N. Insert the hose through one of the holes in the handles of the Top Grain Plate (28), orienting the end of the hose to form a gentle whirlpool once the pump is on.

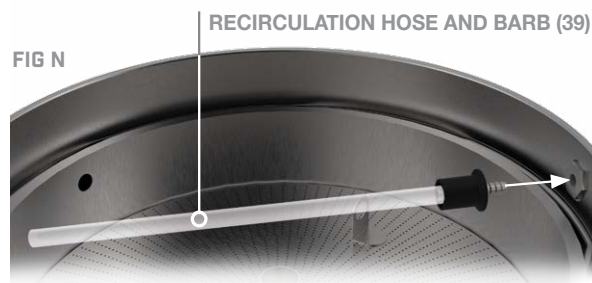

FIG N

10. Recirculate

Activate the pump using the button on the Controller or on the Grainfather Community App to start recirculating, then open the 1/2" Ball Valve (16) and adjust it so that the wort flow is restricted and the wort level is just above the Overflow Inlet (27), allowing a small amount of wort to overflow through the overflow inlet. Fit the Glass Lid (36) to the top of the unit and allow to mash.

CAUTION!



TWO PERSON OR MECHANICAL LIFT REQUIRED.

Grain Basket can weigh up to 60kg (132lbs) during use. Please do not attempt a single-person lift as this could lead to serious injury.

BE VERY CAREFUL when moving the Grain Basket (31) into the sparge position, to ensure the feet at the bottom of the Grain Basket rest securely on the Support Ring (11) as shown. Do not twist the Grain Basket while the basket is in the sparge position which could knock it off the support ring. If the sparge is “stuck” (not draining), then remove the Top Grain Plate (28) and slice the grain bed with a stainless paddle or similar item. Cut through the stuck mash from the centre towards the outside repeatedly until it starts draining. This should keep the Grain Basket safely located on the support ring. Do not stir the grain bed as this could twist the Grain Basket off the support ring. Always ensure the support ring fits tightly into the groove and is held securely in place by the Support Ring Retainer (12).

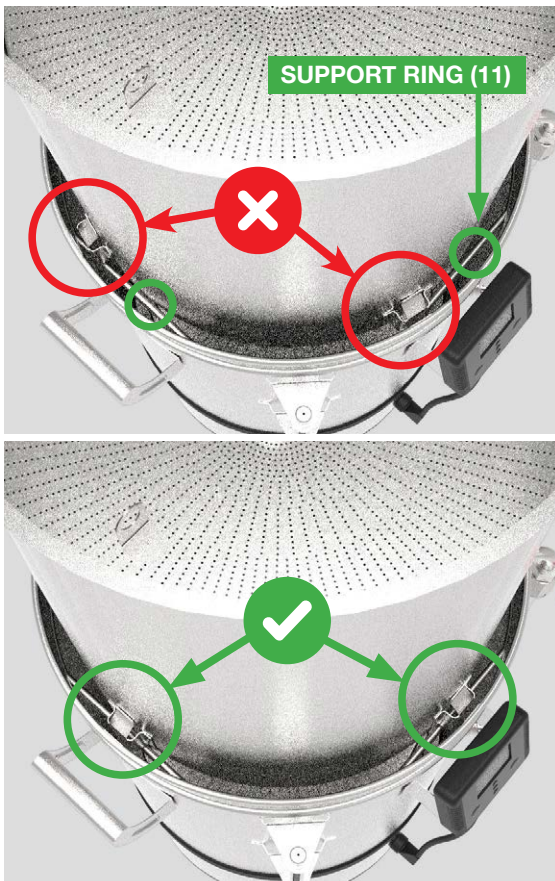

SPARGING

11. Using the Lifting Bar

When the mash is finished, turn off the pump and remove the Glass Lid (36) and Recirculation Hose and Barb (39). Insert the Lifting Bar (37) hooks into the holes in the Grain Basket (31). With one person holding each side of the lifting bar, lift the basket. Turn it 45° so that the feet at the bottom rest securely on the Support Ring (11).



FIG 0

12. Sparging and Grain Basket removal

Gently pour the sparge water evenly over the Top Grain Plate. Aim to keep the water level a few mm above the Top Grain Plate. Once sparging is complete using the same method described in the previous step, lift and remove the entire Grain Basket (31) with grain from the G70 Body. If you are using a large grain bill, it is recommended to gently scoop some grain out of the Grain Basket to reduce the weight prior to lifting it. You can now continue with the brewing process.

BOILING

13. Notes for boiling

NOTE: Do not let the liquid come to a boil while the Grain Basket (31) is still on top, or you will be unable to prevent a boilover. As your wort comes to boil, foam will appear. Use your paddle to gently stir and pat this down mainly in the first 5 - 10 minutes, so it does not boil over.

TIP: Give the wort a good stir before taking the pre-boil SG reading. While the wort boils, add your boil additions as instructed on your recipe. Boil times are usually between 60 - 90 minutes.

CAUTION!

During the boil, do not replace the Glass Lid (36), as you may cause a boilover and removing the Glass Lid may become dangerous. Don't move the G70 Body when full.

14. Cooling with Counterflow Wort Chiller

NOTE: On your first use, run cleaner through the Counterflow Wort Chiller (38) before brewing.

The maximum flow rate for the water is 6L/min. Do not exceed this flow rate as it may cause damage to the counterflow wort chiller (38). The maximum flow rate of wort through the Counterflow Wort Chiller is 4L/min. At this flow rate with 20°C water the resulting wort in the fermenter will be about 25°C. By reducing the flow of the wort through the Counterflow Wort Chiller by adjusting the 1/2" Ball Valve (16), the wort in the fermenter can get as close as 3°C above the municipal water temperature.

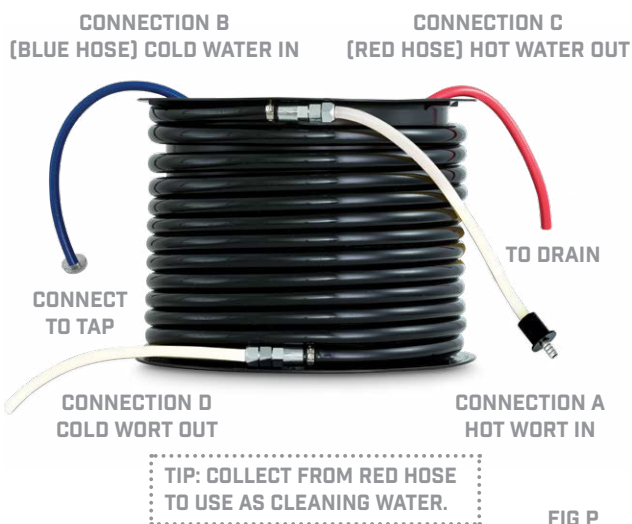

1. At the end of the boil turn the heating element off. Create a whirlpool by stirring the wort vigorously with your paddle or using a whirlpool paddle. The pump is also strong enough to form a moderate whirlpool when not actively boiling. Place the Counterflow Wort Chiller (38) on a table or bench. Push fit the Hose Barb on the end of Connection A (Fig P) into the recirculation opening on the inside of the G70 Body.

NOTE: Ensure that none of your wort or water tubes are sitting underneath the Counterflow Wort Chiller. The water tubes should be coming out from the top (Fig P). If a tube is squashed or there is a kink, this will cause a pressure build up and not allow the liquid to pass through.

2. The coloured hoses (Connection B and C) are the tap water hoses. Connect Connection B to your Tap Adapter (44), this is where cold water goes in. Connection C is where the water drains out hot as it flows through the Counterflow Wort Chiller (38). Connection D is where your wort exits the Counterflow Wort Chiller. To sanitise the Counterflow Wort Chiller put Connection D into the G70 body. Turn the pump on to recirculate the wort back into the G70 Body to sanitise the inside of the coil - complete this step without the cold water circulating. Recirculate for 1 - 2 minutes maximum.

NOTE: The G70 is designed to cool while simultaneously transferring your wort to your fermenter. You should not cool by recirculating into your G70 as this reduces the thermal efficiency.

3. Turn the cooling water on. Once Connection D runs cold, switch the pump off and place the end of the hose inside the clean and sanitised fermenter. Always try to keep the fermenter opening covered to avoid contamination. Take an OG reading of cold wort. Add yeast as instructed on the recipe at the correct yeast pitching temperature.

CLEANING

A. Remove excess liquid from the G70 body

If there is any excess liquid in the G70 Body, follow these steps to clear it:

1. Close the 1/2" Ball Valve (21) shown in Fig Q-1.
2. Place a container underneath the 1/2" Tap shown in Fig Q-2.
3. Open the 1/2" Tap.
4. Turn on the pump until all the liquid in the G70 Body is cleared.
5. Open the 1/2" Ball Valve and close the 1/2" Tap.



FIG Q-1



FIG Q-2

B. Remove trub from the G70 body

Remove the Hop Filter (18) by lifting it with the handle. Take care as the handle may be hot. The filter is designed to take any hop debris (trub) with it, so try to scrape as much of the hop debris onto the hop filter as possible. Once the hop filter is removed, there may still be some hop debris. Insert the Post Boil Cleaning Filter (43) into the cavity as shown in Fig R. Scrape/rinse any excess matter onto the Post Boil Cleaning Filter, this is important to avoid any hop matter getting into the pump. Remove the Post Boil Cleaning Filter with the excess matter on it. Repeat as necessary.



POST BOIL
CLEANING FILTER

FIG R

C. Cleaning the G70 body

Fill the G70 Body with clean water and Grainfather High Performance Cleaner and follow the cleaner directions. Recirculate the cleaner through both the Counterflow Wort Chiller (38) and the Recirculation Hose and Barb (39). When finished, empty the water from the 1/2" Tap (25) as per cleaning step A. Rinse all surfaces that came in contact with the cleaner thoroughly with water. Gently scrub the inside of the G70 Body with a soft bristle brush to remove left over stains.

The Grainfather High Performance Cleaner is a CIP (Clean in Place) cleaner specially formulated to work with hard and soft metals associated with Grainfather systems and other brewing hardware. If you cannot get hold of this, PBW cleaner is also a great alternative otherwise use an alkaline, non caustic, non staining cleaning detergent that's suitable for use with stainless steel and copper. Avoid chlorine-based cleaners, and other corrosive chemicals unsuitable for stainless steel to prevent corrosion, rust or staining.

D. Additional cleaning

You may choose to be very thorough with the cleaning of your Grainfather G70 and we do recommend this to ensure the system performs at its best on each brew. Two other parts that may need your attention are the:

- Sight Glass (4) - Unscrew the Sight Glass Cap (2) and screw on the Sight Glass Cleaning Barb (41) to the sight glass. Push fit the Recirculation Hose and Barb (39) into the recirculation opening on the inside of the G70 Body and connect the free end of the hose to the Sight Glass Cleaning Barb. You can then pump cleaning liquid through the Sight Glass.
- Support Ring (11) - remove the Sight Glass / Recirculation Retention Nut (10) connected to the recirculation opening on the inside of the G70 Body. Next, remove the Support Ring Retainer (12) fitted in the gap of the Support Ring. You can now remove the Support Ring by Applying pressure inwards on it until there is enough clearance for it to be removed carefully from the unit. Reinstall in reverse order. Make sure the Sight Glass / Recirculation Retention Nut and Support Ring Retainer are also replaced correctly as a safety precaution.

**IMPORTANT SAFEGUARDS
READ AND FOLLOW ALL INSTRUCTIONS**

CAUTION – Risk of fire and electric shock. Replace only with manufacturer's cord set, part No. SJTO

**CAUTION:
DO NOT IMMERSE IN WATER.
READ INSTRUCTIONS BEFORE USING.
FOR COMMERCIAL & INDOOR USE ONLY.**

SAVE THESE INSTRUCTIONS



RESOURCES

Check out our [YouTube Channel](#) for how-to's and other helpful videos including a brief instruction video.

For more info visit our FAQ's page <https://shop.grainfather.com/index.php/faq> or checkout our recipes and articles on grainfather.com

GET IN TOUCH

Email info@grainfather.com
NZ +64 6 888 3027
AU +61 2 8074 3798
US +1 (562) 354-4603
UK/EU +44 1750 432048



www.grainfather.com

DOWNLOAD THE APP

