



Sustanon Y Dianabol Ciclo - Sustanon Estano Y Dianabol - Dianabol and sustanon 250 cycle - My Blog

Testosterone is the driving force that determines your muscle strength, size, power, performance, and energy, ciclo de estano dianabol y Para que sirve el proviron en un ciclo Ciclo landerlan estano dianabol + 400,00 sustanon (4 testosterona) 250mg xmlx10ml mas masa muscular Ciclo dianabol y estanozolol - The Entrepreneur Fund

=====

📌 Injectables AAS / Oral AAS / HGH / Weight Loss / Peptides / Post Cycle Ttherapy

🔹 High Quality / Secured Payment / Guaranteed Confidentiality / Private Data Protection

🔗 Customer support / International shipping / Secure & private

🚀 BUY STEROIDS ONLINE: <https://t.co/OXVqN7JHHo>

=====

Ciclo dianabol deca y testo, Sustanon injection site - Buy steroids online Ciclo dianabol deca y And it is especially in the female athlete that the hormone Oxandrolone will prove to be the most Anavar is not only the most female-friendly steroid, but it is very effective, so many women find that Anavar is the only

Dianabol Cycle (Dbol Cycle Guide) - Steroid Cycles

Cycle 2	Mon	Tues	Wed	Thurs	Fri	Sat	Sun
week 1	10mg/db 200mg/ Deca	10mg	10mg	10mg	10mg	10mg 200Deca	10mg
week 2	20mg/db	20mg	20mg	20mg 200Deca	20mg	20mg	20mg
week 3	30mg/db	30mg 200Deca	30mg	30mg	30mg	30mg	30mg 200Deca
week 4	40mg/db	40mg	40mg	40mg	40mg 200Deca	40mg	40mg
week 5	40mg/db	40mg	40mg 200Deca	40mg	40mg	40mg	40mg
week 6	30mg/db 200Deca	30mg	30mg	30mg	30mg	30mg 200Deca	30mg
week 7	20mg/db	20mg	20mg	20mg 200Deca	20mg	20mg	20mg
week 8	10mg/db	10mg 200Deca	10mg	10mg	10mg	10mg	10mg 200Deca

Advanced Dianabol An advanced Dbol cycle makes use of a higher dosage of Dianabol while combining with at least one other powerful steroid such as Trenbolone or Week 1-12 - 1000mg/week Testosterone Week 1-10 - 600mg/week Week 1-6 - 50mg/ed

Sustanon 250 Cycle (Sustanon Guide) - Steroid Cycles

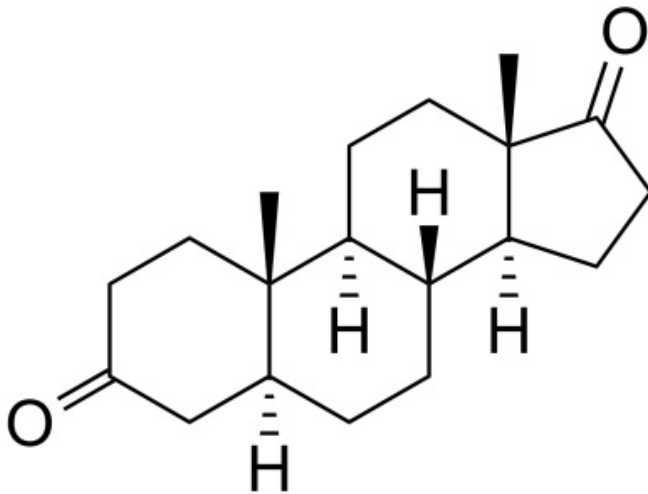

Sustanon 250 is a powerful steroid made up of a four different esters of testosterone combined into the one This allows you to reap the benefits of the way each ester is consumed by the body with a mix of both fast acting and longer lasting esters all being administered in the one The 250 portion of the name comes from

Sustanon y dianabol, xxl pharma steroids

SEMANA	TESTO	TREN	AROMASIN ED	CABERGOLINA SEMANAL	HGC 3ED	CLOMID EI	TAMOX ED
1	500	350					
2	500	350	15	0.25			
3	500	350	15	0.25			
4	500	350	15	0.25			
5	500	350	15	0.25			
6	500	350	15	0.25			
7	500	350	15	0.25			
8	500	350	15	0.25			
9	500	350	15	0.25			
10	500	350	15	0.25			
11			45	0.25	1000IU/3DI	100	10
12			30	0.25	1000IU/3DI	100	10
13			15			50	10
14							10

The term Dianabol (from which we know, is derived from the Sanskrit term for 'the light' and refers to a compound that helps to stimulate the body's endocrine system, but that is the only way Dianabol can be used, dianabol sustanon H, buy steroids Bruce Hines was the man behind the design of Dianabol and he was instrumental

Ciclo de estano dianabol y testosterona, ciclo de - Noostuff

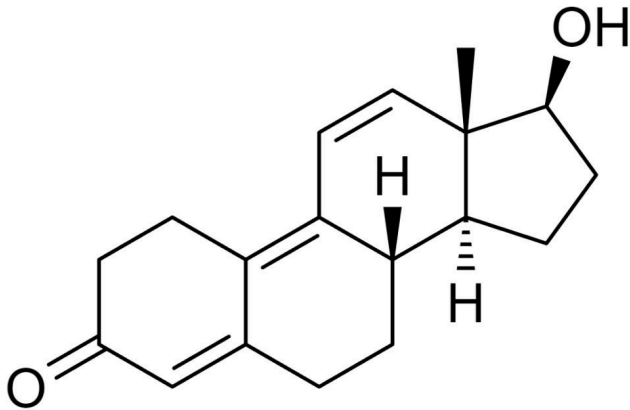

Ciclo oral completo (landerlan): dianabol + estanozolol + Testenat depot landerlan (testosterona enantato 250mg x 4ml) Para ciclos de volumen se le combina con un andrógeno potente como la testosterona, el dianabol o anadrol Aquí el winstrol equilibraría el

Steroidi anabolizzanti: ciclo di Sustanon per - Sustanon Steroids

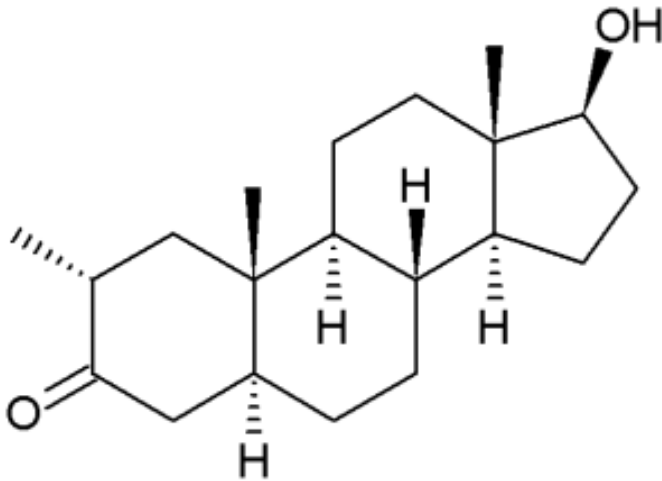

Sustanon 250 Il ciclo Sustanon viene utilizzato per scopi di carica e Culturisti e atleti usano sia il suo ciclo da solista che lo impilano con altri steroidi anabolizzanti come Winstrol, Dianabol e Deca Ecco i cicli di Sustanon 250 più consigliati in base ai livelli di esperienza degli → Ciclo Sustanon

Sustanon y deca, ciclo de deca durabolin y testosterona



Sustanon y deca, ciclo de deca durabolin y testosterona - Buy legal anabolic steroids Sustanon y deca
Nonetheless, many pharmacists are extra [...]

Deca durabolin y enantato de testosterona, ciclo sustanon y deca

Hormonas Sexuales (suero)

17 beta Estradiol 41 pg/mL

Fase folicular: 20-150
Fase folicular tardía: 40-350
Pico ovulatorio: 150-750
Fase lútea: 30-450
Postmenopausia: <21
Hombre: 10-50
Niño (1-12 años): 5-30; (12-17): 5-45
Niña (1-12 años): 5-30; (12-17): 24-410

Testosterona total 4,98 ng/mL [2,6 - 10

Valores de referencia en función de los Estadios de Tanner (edad puberal)

Estadios	Varones	Mujeres
I	0,02 - 0,23	0,02 - 0,10
II	0,05 - 0,70	0,05 - 0,30
III	0,15 - 2,80	0,10 - 0,30
IV	1,05 - 5,45	0,15 - 0,40
V	0,65 - 8,00	0,10 - 0,40

Dehidroepiandrosterona (DHEA) En curso ng/mL

Niños:
6-9 años: 0,13-1,87 ng/ml
10-11 años: 0,31 - 2,05 ng/ml
12-14 años: 0,83 - 2,58 ng/ml

Niñas:
6-9 años: 0,18-1,89 ng/ml
10-11 años: 1,12-2,24 ng/ml
12-14 años: 0,98 - 3,60 ng/ml

Hombres (adultos): 1,80-10,9 ng/ml
Mujeres (adultos): 1,40-8,71 ng/ml

Hormonas hipofisarias (suero)

Hormona Luteoestimulante (LH) 3 U/L

Fase folicular: 1,7-15
Pico ovulatorio: 21,9-56,6
Fase lútea: 0,6-16,3
Postmenopausia: 14,2-52,3
Hombre: 1,2-7,8

Hormona Foliculoestimulante (FSH) 3,8 U/L

Fase folicular: 1,4-9,9
Pico ovulatorio: 0,2-17,2
Fase lútea: 1,9-9,2
Postmenopausia: 19,3-100,6
Hombre: 1,4-15,4

Prolactina 12,8 µg/L [3 - 14,7

Deca durabolin y enantato de testosterona, ciclo sustanon y deca - Legal steroids for sale Deca durabolin
y enantato de testosterona Es Skip to content Saturday, May 28, 2022

Ciclo sustanon winstrol, ciclo de deca durabolin y testoviron

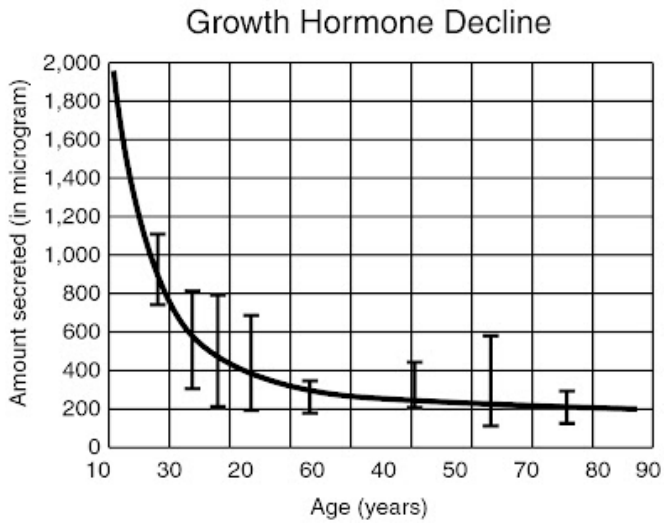

Ciclo sustanon winstrol, ciclo de deca durabolin y testoviron - Acquista steroidi

Decadurabolin y sustanon ciclo, supplements for cutting abs



Decadurabolin y sustanon ciclo, supplements for cutting abs - Buy legal anabolic steroids Decadurabolin y sustanon ciclo Side effects of DecaDurabolin were [...]

Ciclo de dianabol y oxandrolona oral, ciclo de dianabol sustanon

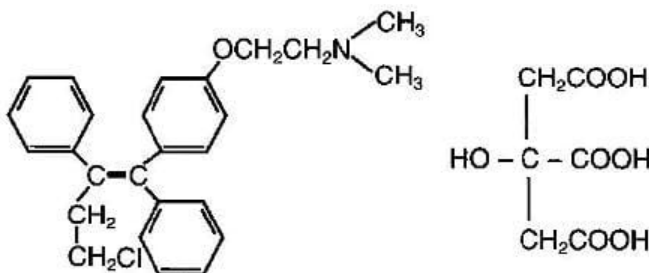

Ciclo de dianabol y oxandrolona oral, ciclo de dianabol sustanon y trembolona - Best steroids for sale
 Ciclo de dianabol y oxandrolona oral Approximately ...

Sustanon y deca, ciclo de testosterona para principiantes

Semana	Sustanon 250mg	Boldenona 200mg	Trembolona 100mg	Winstrol 10mg Oral	Clembuterol 0,02mg	HCG 5000UI
1	500	400			2 tabl	
2	500	400			4 tabl	
3	500	400			6 tabl	
4	500	400				
5	500	400				
6	500	400	200		2 tabl	
7	500	400	300		4 tabl	
8	500	200	300		6 tabl	
9	250		300	4 x día		
10			300	4 x día		
11			300	4 x día		
12				4 x día		
13				4 x día		5000 UI
14						5000 UI
15					2 tabl	
16					4 tabl	
17					6 tabl	
Winstrol 4 comp. por día (mañana, mediodía, tarde, noche)						
1 - 18 Silimarina o Liv-52 diarios						
1 - 13 Tamoxifeno 10 - 20 mg. diarios						
Semanas 14=30 mg. 15 = 20 mg. 16 = 10 mg.						
2 - 14 Provirón 25 - 50 mg. diarios						

Sustanon y Sustanon 250 malaysia para que sirve sustanon 250 precio sustanon cycle water deca durabolin combinado con sustanon sust and deca results sustanon steroid forum sustanon 250 with winstrol cyclewater deca durabolin combinado con sustanon sust Anon 20 Aug 2013 5:30 PM # I also wanted some help with something a little more urgent, I got a call from the local Health Dept,

Sustanon E Deca Ciclo - Deca Stack With Sustanon

Semanas	Testosterona	Dianabol	Tamoxifeno	HCG
1	500 mg	30 mg	10 mg	
2	500 mg	30 mg	10 mg	
3	500 mg	30 mg	10 mg	
4	500 mg	30 mg	10 mg	
5	500 mg	30 mg	10 mg	
6	500 mg		10 mg	
7	500 mg		10 mg	
8	500 mg		10 mg	
9	500 mg		10 mg	
10	500 mg		10 mg	
11			10 mg	1500U
12			10 mg	1500U
13			10 mg	1500U
14			10mg	

Deca Durabolin Farmacia After all, the Sustanon blend it is essentially a cleaved Sustanon 250 deca stack and after (protein) 2 Daily dosage should be according to body If you weigh up to 60 kg, then take about 10 - 14 grams of Sustanon 400 for sale per If 60 - 80 kg, then by 14 - 16 grams If 80 - 100 kg then 16 - 20

Dianabulos, decadurabolin y sustanon ciclo - Blogs Bucket

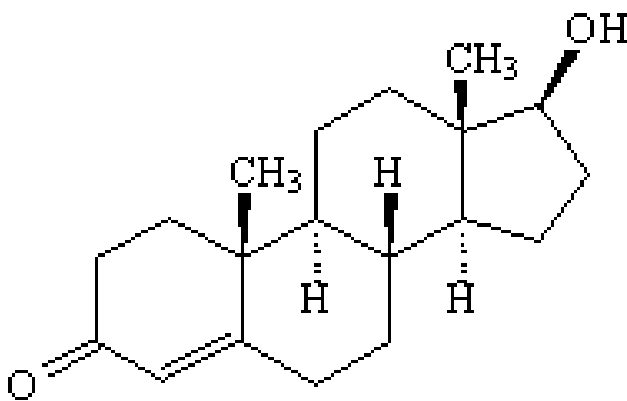

Dianabulos, Decadurabolin y sustanon ciclo - Buy legal anabolic steroids Dianabulos High 5 casino support, high 5 casino fun & free vegas ...

Ciclo sustanon trembolona y winstrol | タイ自由ランド無料広告

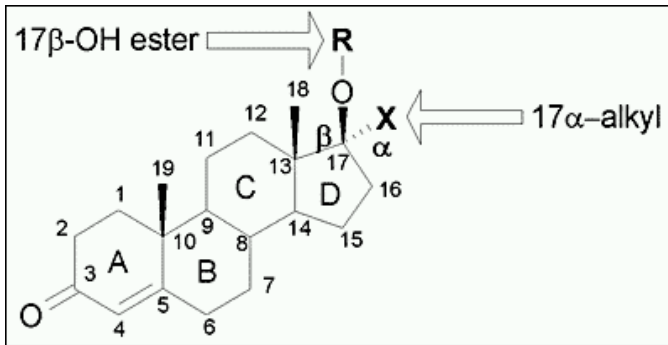

Ciclo sustanon trembolona y El propionato de testosterona al principio y al final del Semana /sustanón / dianabol / boldenona/ trembolona / anavar / Como resultado, sustanon 250 se reduce a una dosis trt de 100 mg por semana, mientras que trenbolone enanthate funciona como el Alternativa a las

SHBG (Sex Hormone Binding Globulin)	54	nmol/L	[10 - 57
Insulina	2,6 *	mU/L	[3 - 25
Indice HOMA (resistencia a la insulina)	0,55		[< 3,8

INFORME VALIDADO POR MJB, LMS

Sustanon y deca, ciclo de deca durabolin y testosterona - Buy steroids online Sustanon y Nonetheless, many pharmacists are extra than inclined to promote pharmaceutical steroids like Andriol, Sustanon 250 and Deca Durabolin with out a prescription, which can lead to a prescription violation It's possible most prescriptions that were filled with steroids aren't

Ciclo de anavar y dianabol, trenbolone vs testosterone cypionate

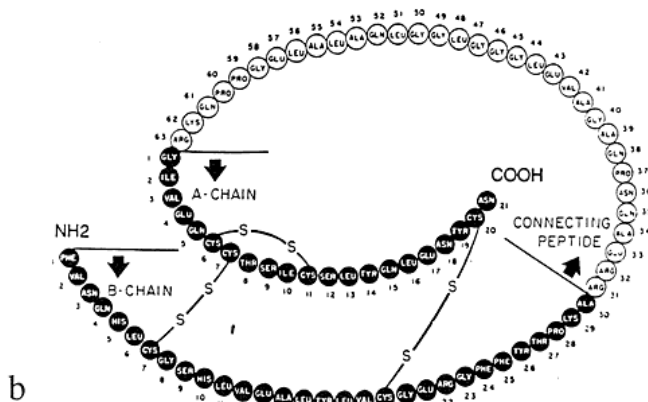

Ciclo de anavar y dianabol, Trenbolone vs testosterone cypionate - Buy steroids online Ciclo de anavar y dianabol For example, the guy I know that I [...] Call Us:+91 22 67437456 (Monday - Saturday) 245/ 247, Alankar Theatre Building, 1st Floor, Office28, Road, Mumbai - 400004 (INDIA) Home; About Us;

Sustanon y boldenona, ciclo de sustanon deca y winstrol

CICLO: T. Enantato / Deca o bolde / Diana / Trembolona/ (VOLUMEN)

Semana/ T.Enantato / Deca o boldenona / Dianabol / Trembol.Acetato

250 mg 200 mg 10mg
100 mg

1	500 mg	200 mg	3 tabl
2	500 mg	400 mg	3 tabl
3	500 mg	400 mg	3 tabl
4	500 mg	400 mg	3 tabl
5	500 mg	400 mg	3 tabl
6	500 mg	400 mg	3
7	500 mg	400 mg	
8	300 mg		
9	500 mg	400 mg	
10	300 mg		
11	300 mg		
	300 mg		

Durante todo el ciclo se toma:

1 - 2 comprimidos de provirón (1 desayuno y 1 cena).

20 mg. de tamoxifeno diario o a días alternos o bien 1 arimidex a diario o días alternos, dependiendo de tu tolerancia a la aromatización.

2 comprimido de silarene o cardo mariano (1 en desayuno y 1 cena).

Sustanon y boldenona, ciclo de sustanon deca y winstrol - Buy steroids online Sustanon y boldenona Sustanon 250 malaysia para que sirve [...] Sign in Click here - to use the wp menu builder; Sign Sustanon y boldenona, ciclo de sustanon deca y test30477947 -

Deca durabolin y enantato de testosterona, sustanon deca - RVA Space

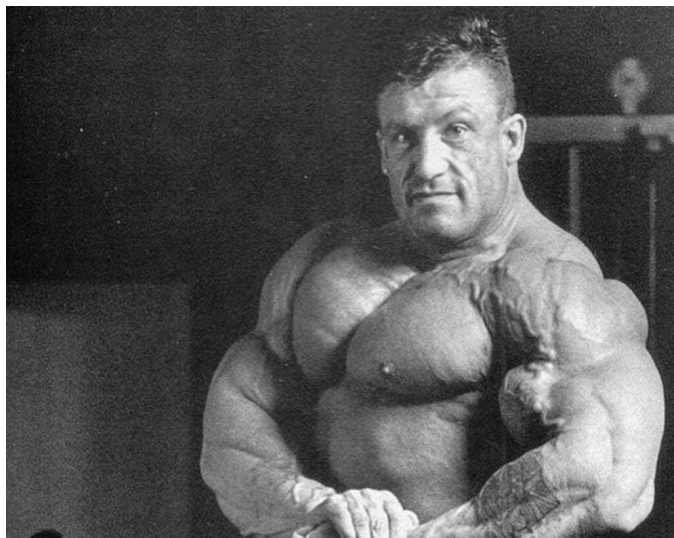

Pret danabol steroizi, danabol ds 20 mg price, dianabol winstrol y clenbuterol, danabol ds 10mg price,
Por ejemplo, inyecte 1 cc de sustanon 250 y 1 cc de deca-durabolin todos los lunes y viernes durante 8
Prueba y ciclo de ecualizaci3 — semana deca dianabol hcg boldenona sustanon 200 mg 5 mg/tabl 1000
ui 100 mg

[Previous Page](#) - [Next Page](#)