



EVER ADVANCED

INSTRUCTION MANUAL

Stroller Wagon|TR-21827



sample tested to meet U.S. Federal, ASTM and other safety requirements

Patent Pending

**READ ALL INSTRUCTIONS BEFORE ASSEMBLY AND USE OF PRODUCT.
KEEP INSTRUCTIONS FOR FUTURE USE.**

The EA kids flat fold stroller wagon is a new product that is specifically designed for children. It features two seats for children age 2-7 and the maximum combined weight for two children is 110LBS. Each seat holds up to 55 lbs. It is designed with an adjustable push handle, a telescopic pull handle, 5-point safety harness, front and rear locking wheels, an integrated tray, a canopy for shade and much more. The unique features design to keep your children comfortable and safe.

TABLE OF CONTENTS

WARNING AND GENERAL SAFETY INFORMATION	Pg.3
EA KIDS FLAT FOLD STROLLER WAGON	Pg.4
-Parts In The Box	Pg.4
Assembly Instructions	
-Unpacked Product For Assembly.....	Pg.5
-Installing Rear Axle.....	Pg.5
-Installing Rear Wheels.....	Pg.5
-Installing Front Wheels.....	Pg.6
-Unfolding and locking the product.....	Pg.6
-Adjusting the push and pull Handle.....	Pg.7
-Installing the integrated tray	Pg.8
-Installing The Canopy.....	Pg.8
-Folding and Locking The Product.....	Pg.9
Set Up and Use	
-Use of pull handle.....	Pg.10
-Use of push handle.....	Pg.10
-Use of the Front and Rear Bags.....	Pg.10
Braking Systems	
-Front Wheel brakes.....	Pg.11
-Front wheel individual direction lock.....	Pg.11
-Locking Rear Axle.....	Pg.11
HARNESS- Use of The 5-Point Safety Harness	
-Changing Shoulder Harness Anchor Points.....	Pg.12
-Locking and Unlocking the Safety Harness.....	Pg.13
-Adjusting the Length of Safety Harness.....	Pg.14
Disassembly Instructions	
Remove wagon wheels	
-Remove Rear Wheels.....	Pg.15
-Remove Rear Axle.....	Pg.15
-Remove Front Wheels.....	Pg.15
Remove Fabric	
-Remove Main Fabric.....	Pg.15
Care and Maintenance	Pg.16
Customer Assistance and Questions	Pg.16

WARNING

PLEASE READ AND FOLLOW ALL OF THESE INSTRUCTIONS TO ENSURE THE SAFETY OF YOUR CHILD. KEEP THESE INSTRUCTIONS FOR FUTURE USE.
FAILURE TO FOLLOW THESE INSTRUCTIONS COULD RESULT IN SERIOUS INJURY OR DEATH.

IMPORTANT! This wagon is recommended from children age 2-7. Not intended for children under 2 years of age.

WARNING! CHOKING HAZARD. Adult assembly required because of small parts. Keep assembly parts out of reach of children under 3 years.

WARNING! NEVER leave children unattended. ALWAYS keep children in view while in the product.

WARNING! This wagon is suitable for use with one or two child occupants. The use of more than two children may cause an unstable condition which can injure your child. The maximum combined weight for two child occupants is 110lbs. Each seat holds up to 55 lbs.

WARNING! Check that the safety harness and all attachment devices are correctly engaged before use. Ensure your child is properly positioned and using the safety harness during use.

WARNING! Ensure that all locking device are engaged before use.

WARNING! Check that the fabric is correctly engaged before use.

WARNING! DO NOT use product if any parts are missing or broken.

WARNING! Children must remain seated, secured by safety harness, and ALWAYS keep their arms and legs inside while riding.

WARNING! ALWAYS apply brakes when taking children in or out and never leave child unattended.

WARNING! Make sure all items in the wagon are properly secured and away from children to reduce the risk of injury.

WARNING! To avoid injury, ensure that your child is kept away when unfolding and folding this product. There are pinch points between the product supports and frame that may injure fingers. Stay clear of pinch points when opening or closing the product or when adjusting.

WARNING! DO NOT allow child to climb on, into or out of product unassisted. DO NOT allow child to jump on seat.

WARNING! This wagon is NOT A TOY! DO NOT let your child play in or around this product.

WARNING! Load attached to the handle or sides will affect the stability of the wagon.

WARNING! DO NOT hang items on the product at any time. The product may become unstable.

WARNING! DO NOT sit on top rail or canopy, this may cause serious injury.

WARNING! DO NOT sit on the top of the tray, maximum load bearing of the detachable integrated tray is 11LBS.

WARNING! The maximum weight capacity of the rear backpack bag is 10.8LBS, the maximum weight capacity of the front cover pocket and cup bag is 1.54LBS/bag.

WARNING! DO NOT place hot liquids in storage pockets. Spills can burn you or your child. Sharp or heavy objects placed in pockets may cause damage to the product, or injury to the child

WARNING! DO NOT make any alterations or modifications as this may cause instability or structural damage not covered under warranty or lead to injury. If a parcel bag other than one recommended by the manufacturer is used, the product may become unstable. DO NOT install mattresses or similar items for in wagon.

WARNING! DO NOT use as a child car seat or to transport children in a motor vehicle.

WARNING! DO NOT use the product on stairways, escalator, or moving walkway.

WARNING! Use at a normal walking pace only; faster strolling can cause a loss of control and injury to the child.

WARNING! DO NOT use the product while running or jogging, with bicycles or motor vehicles, or while skating or during other similar activities.

WARNING! DO NOT park on elevated or sloped surface with children on board, even if the brakes have been locked. Use caution on uneven surfaces.

WARNING! DO NOT use near open flames or other sources of heat. This product is flammable.

WARNING! AVOID STRANGULATION: – DO NOT suspend strings or toys from the canopy.

– DO NOT place product anywhere near cords from window blinds, draperies, phone, etc.

– DO NOT place items with a string around your child's neck such as hood strings or pacifier cords.

– If not properly secured, the child may slip into leg openings and strangle.

EA KIDS FLAT FOLD STROLLER WAGON



Parts in the box



Rear wheels (x2)



Front wheels (x2)



Canopy set
(fabric canopy and canopy pole set)



Locking rear axle



Integrated tray



Assembly wagon

ASSEMBLY INSTRUCTIONS



Unpacked Product For Assembly

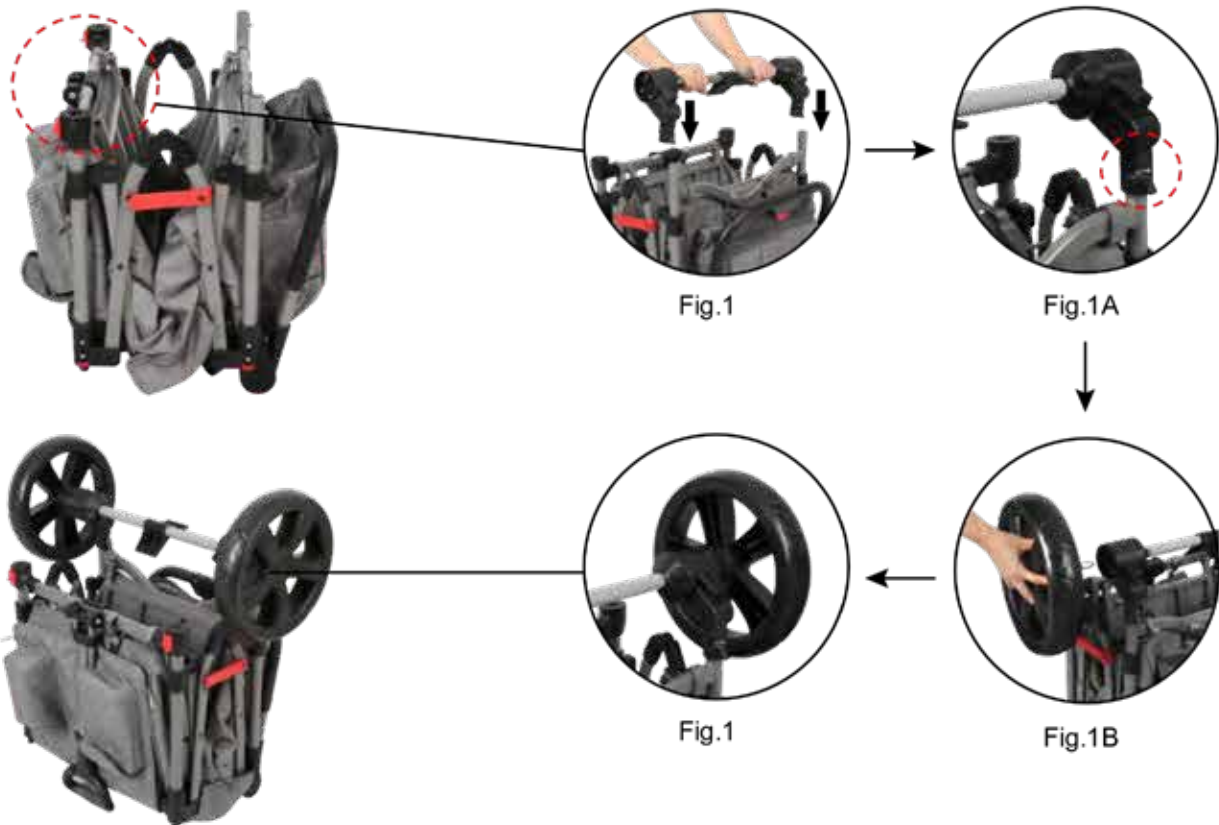

Installing rear axle

1. Position rear axle on kids wagon frame with pin facing outward as shown below. Fig.1
2. Make sure the position of the pin aligned with the hole site. Fig.1
3. Push axle assembly down on frame as shown. Fig.1
4. Axle shown properly locked to kids wagon frame. Fig.1A

Installing rear wheels

1. Put the rear wheels face toward the axle as shown. Fig.1B
2. Insert the wheels on the axle and make sure the wheels are secured. Fig.1C

ASSEMBLY INSTRUCTIONS

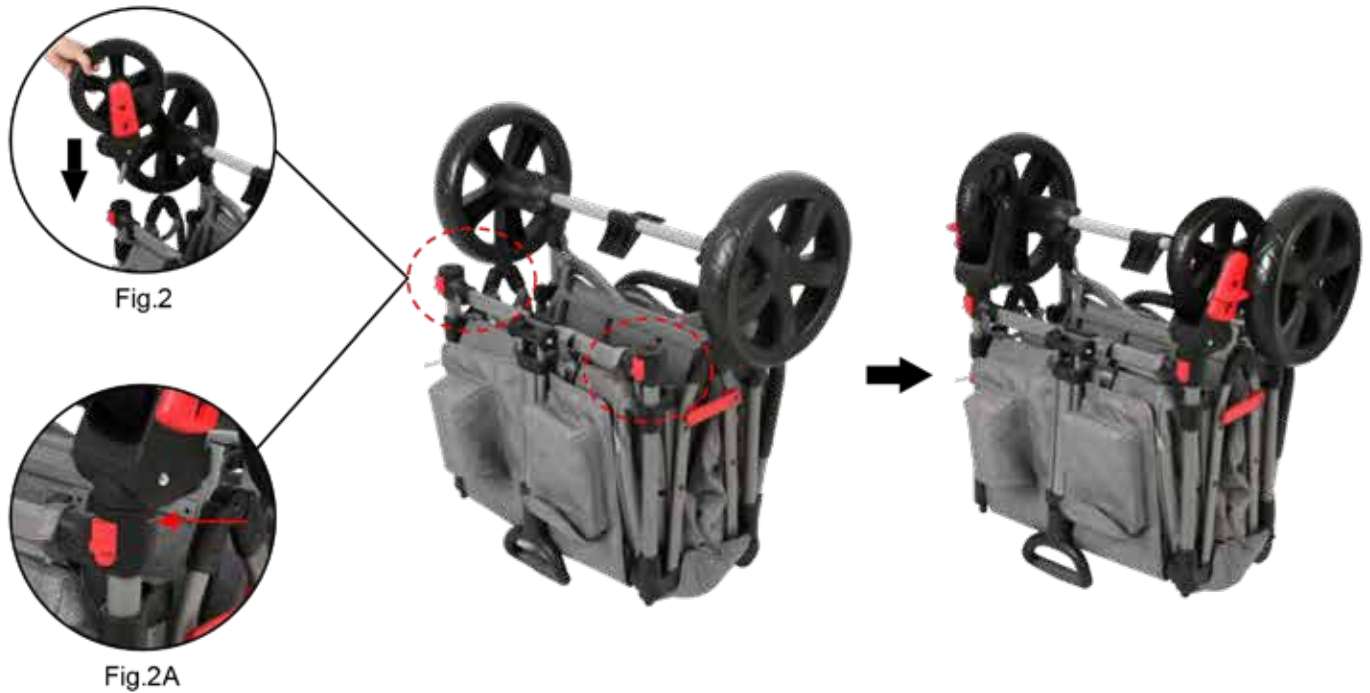

Installing front wheels

1. Put the front wheels face downwards as shown. Fig.2
2. Insert wheel on the kids wagon frame and make sure the front wheels are secured. Fig.2A

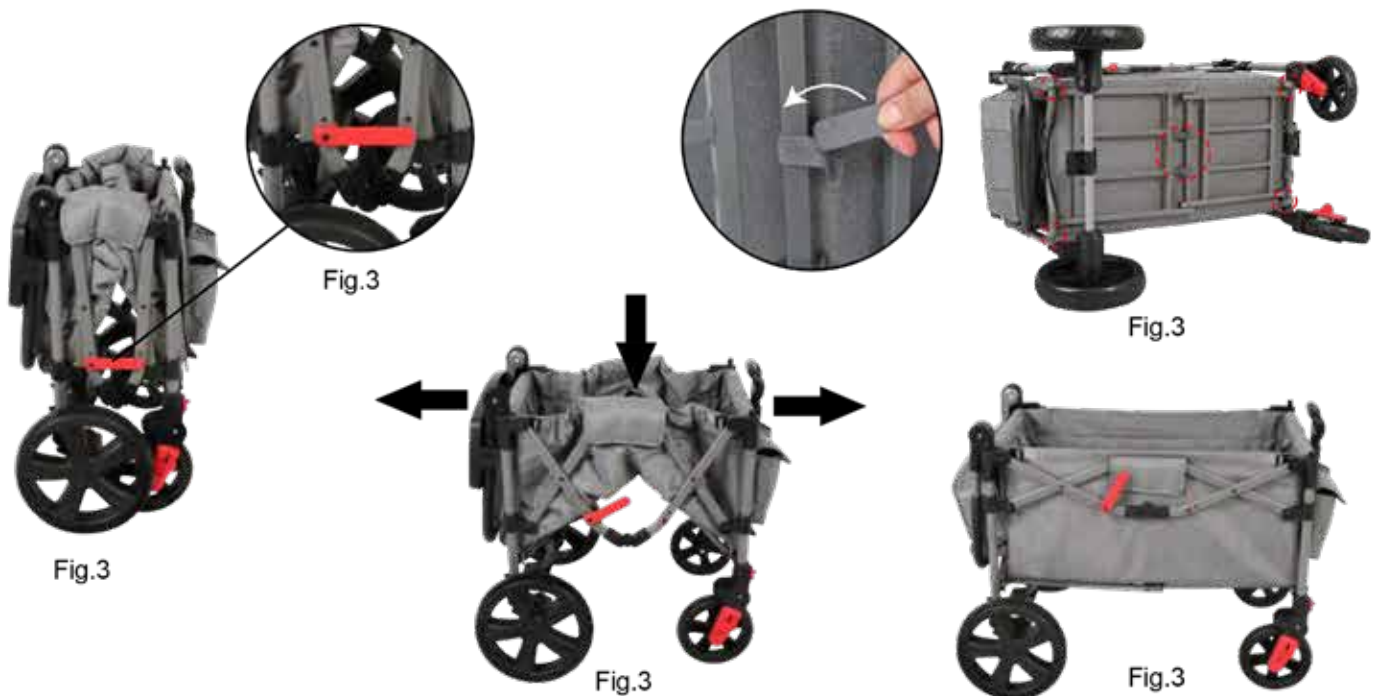

Unfolding and locking the product

1. Unlock the side auto lock. Fig. 3 3A
2. Pull to the sides to open the product and unfold. Fig.3B
3. Put the kids wagon side down, make sure the velcros are fastened on the bottom bar as shown. Fig.3C
4. Right the kids wagon, press the bottom of the wagon until it is fully opened. Fig.3B Fig.3D

ASSEMBLY INSTRUCTIONS

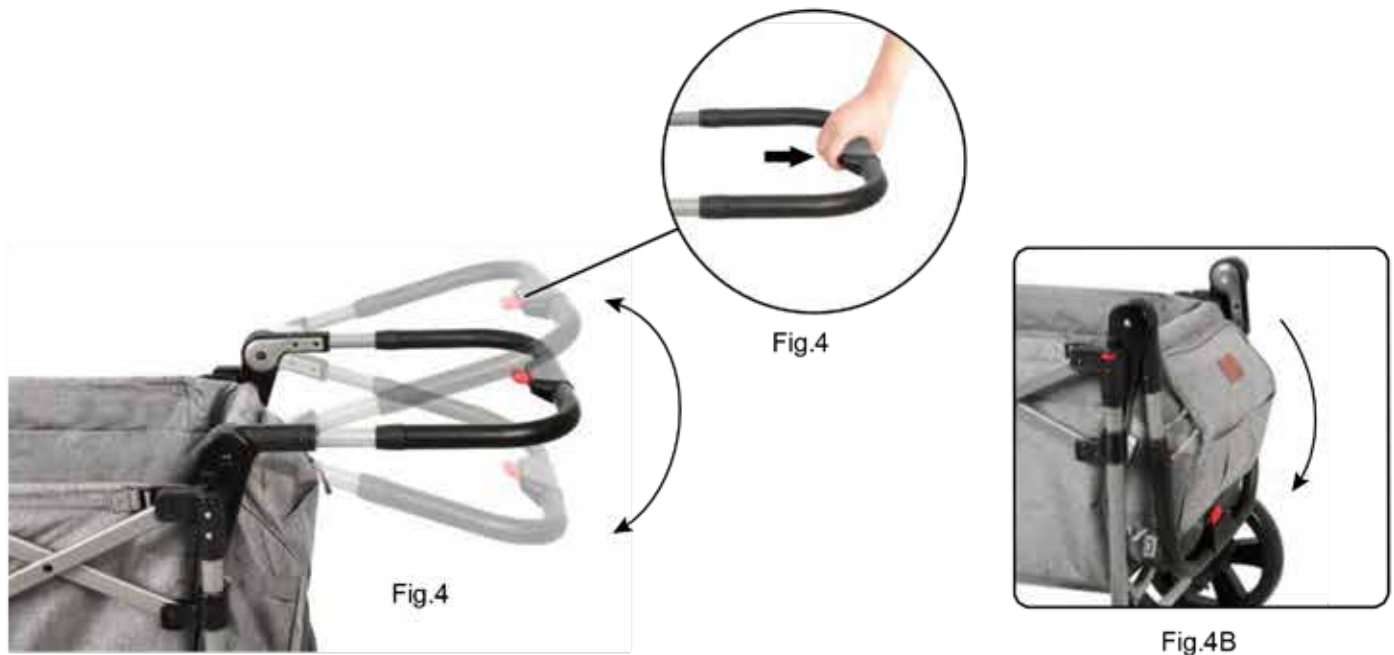

Adjusting the push handle

1. Push the red button on the center of the push handle to make adjustments. Fig.4 Fig.4A
2. When not using the push handle, press the red button continuously until the handle folds downward. Fig.4B

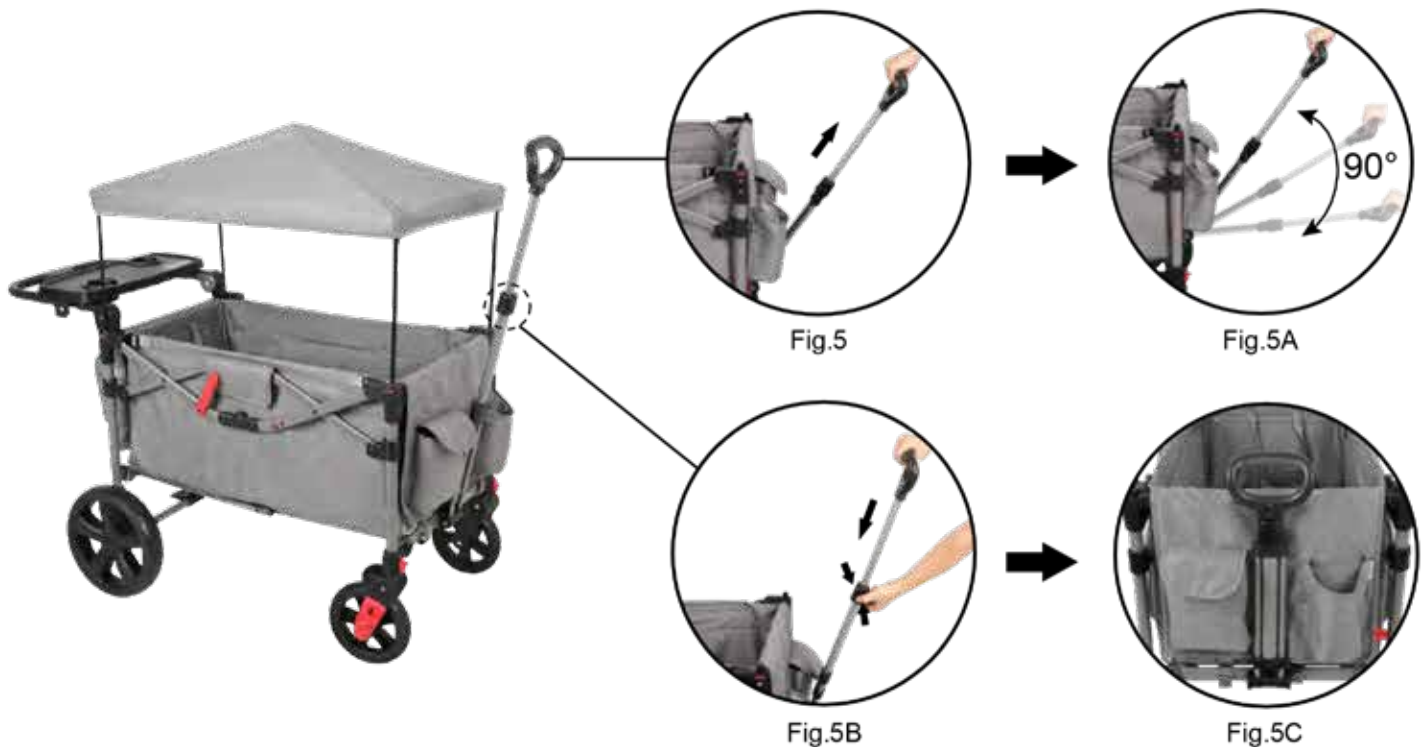

Adjusting the pull handle

1. Hold the "D" shape handle and pull out directly. Fig.5
2. In this range, pull handle can be used and held at whatever position is best for your needs. Fig.5A
3. When not using the pull handle, press and hold the unlock button on both sides of the telescopic sleeve while pressing down the "D" shape handle until it is completely closed. Fig.5B Then fold the pull handle toward the wagon vertically. Fig.5C

ASSEMBLY INSTRUCTIONS



Fig.6



Fig.6A



Fig.6B

Installing the integrated tray on the main wagon

1. Pull fabric off as shown and the side frame is exposed. Fig.6A
2. Place the tray on the side frame as shown, then clip the outer groove on two sides of the frame. Fig.6B
3. Ensure the integrated tray fully fits. Use the tray to keep drinks, snacks and any other important items for your children nearby.

WARNING! Do not put items on the tray when moving, Your children will get hurt as the items can not be secured on the tray.



Fig.6C



Installing the integrated tray on the push handle

1. Place the tray on the push handle as shown and clip the inner groove on the handle. Fig.6C
2. Lay the push handle flat as shown with the integrated tray installed and use it for holding drinks and snack.

WARNING! Do not put items on the tray when moving.

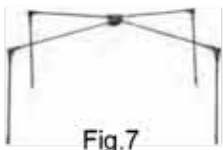

Fig.7

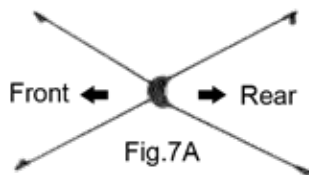

Fig.7A



Fig.7B

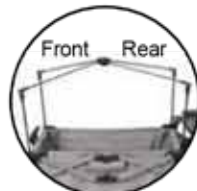

Fig.7C

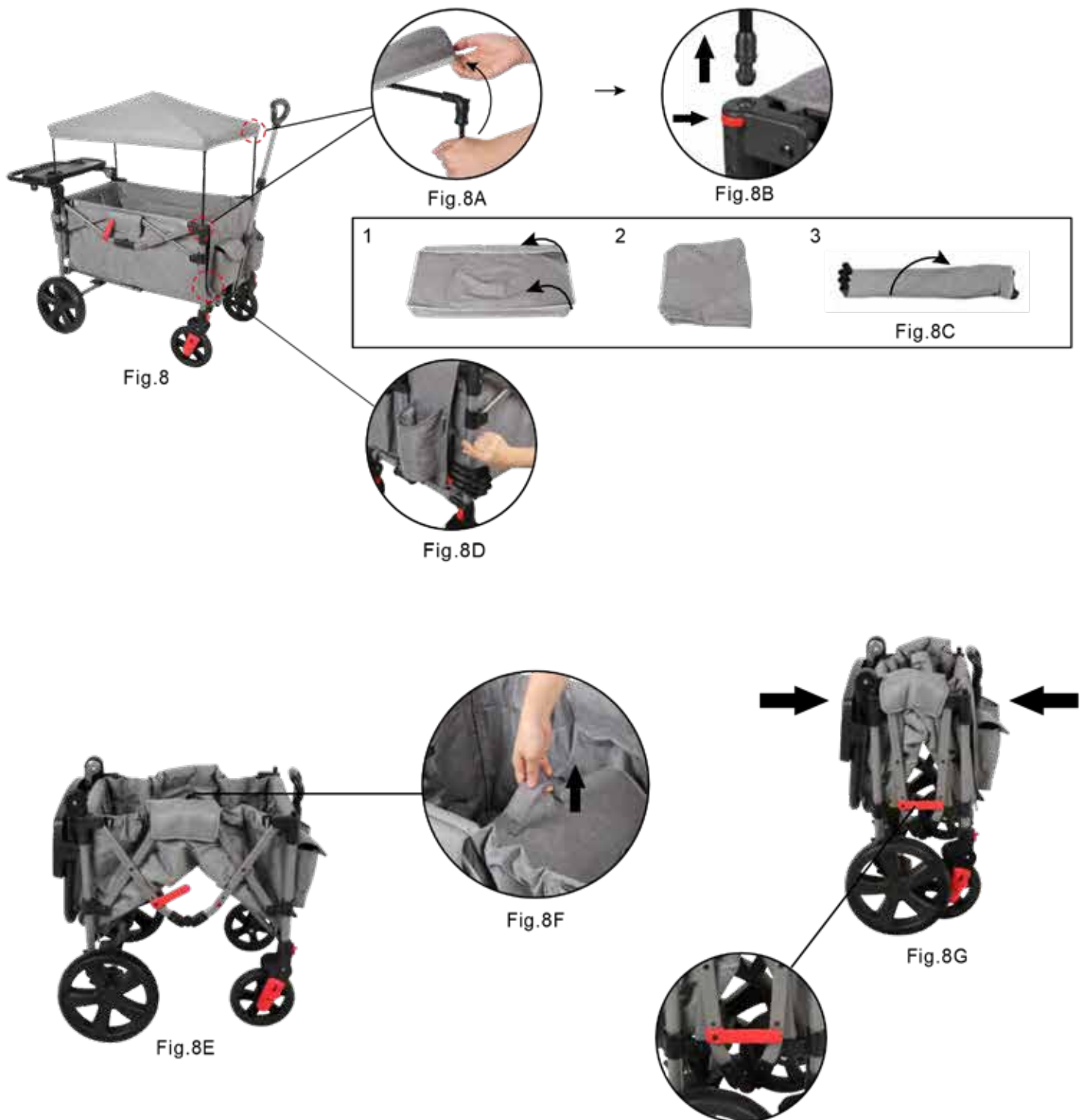

Fig.7D

Installing the canopy

1. Unfolded the canopy support pole. Fig.7
2. Please make sure the hub is facing the direction as shown. Fig.7A
3. Insert canopy support pole ends into the housing directly one by one. Make sure the red button pops up and the four canopy support poles are firmly inserted. Fig. 7B 7C
4. Put the canopy on the top, tie the inner elastic rope to the head of the plastic joints. Make sure all four corners are fastened. Fig.7D

ASSEMBLY INSTRUCTIONS



Folding and locking the product

1. Take off the canopy fabric. Fig.8A
2. Press the red button then take out the canopy pole directly. Fig.8B
3. Put the canopy pole set on the canopy fabric, wrapped as shown. Fig.8C
4. Put the whole canopy set in the front zipper bag and zip it. Fig.8D
5. Press the red button on the push handle and adjust it to the "Not in use" position. Fig.8E (Fig.4B)
6. Press and hold the unlock button on both sides of the telescopic sleeve, while pressing down the "D" shape hand until it is completely closed. Fig.8E (Fig.5C)
7. To fold the kids wagon, pull up on the strap located at the interior center of the wagon. Fig.8F
8. Fold on both sides to lock. Fig.8G

SET UP AND USE



Fig.1

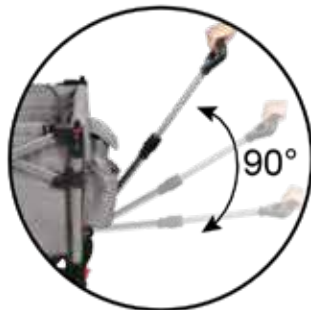

Fig.1A



Fig.1B

Use of pull handle

1. Please refer to "Adjusting the pull handle" on page 7.



Fig.2



Fig.2A



Fig.2B

Use of push handle

1. Please refer to "Adjusting the push handle" on page 7.
2. Place both hands on the handle to maneuver.



Fig.3A



Fig.3B



Use of the Front and Rear Bags

1. The photo shows the front bags. One cup holder bag, one small pocket with cover and one zip bag for storing canopy set. Fig.3A
2. One backpack style rear bag. The upper layer is a larger storage space that can be used to store clean items. The lower pocket is a mesh part that can be used to store dirty shoes, used diapers and other items. Fig.3B

BRAKING SYSTEM

WARNING! Always apply brakes when taking children in or out.
Always apply brakes when taking items in or out.
Always apply brakes when not holding the handle or leaving the wagon unattended.

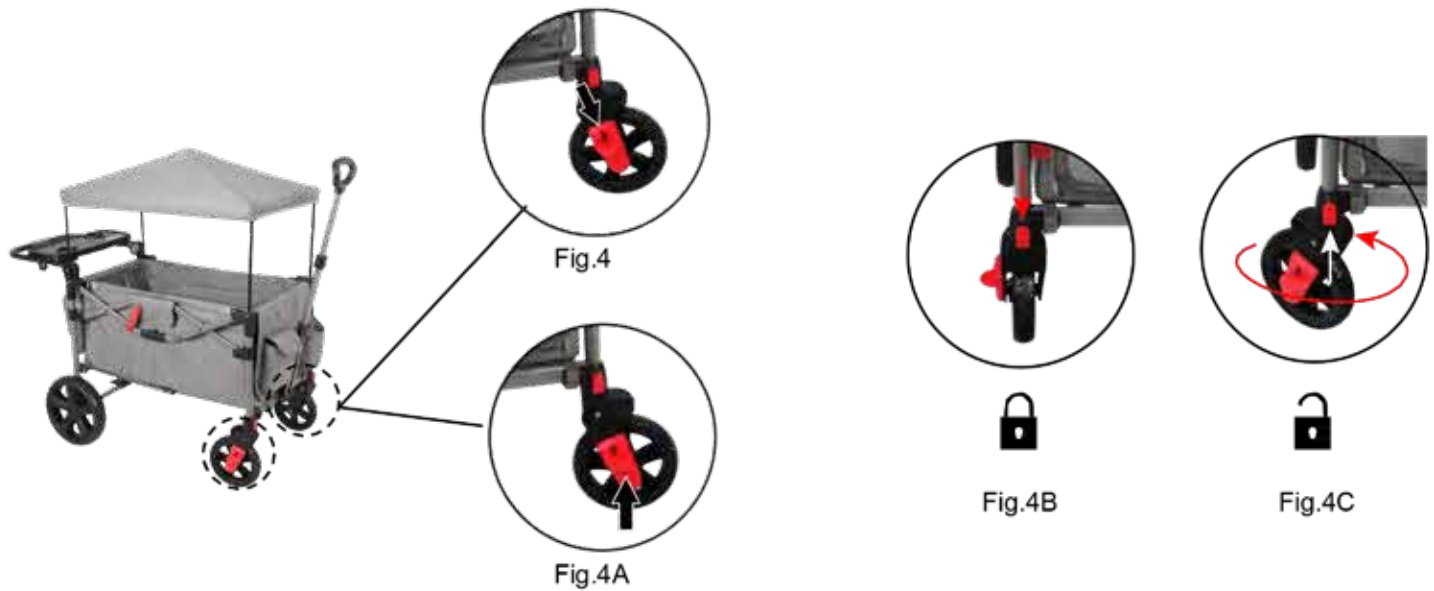

Front wheel brakes

1. To lock: Step downward on the side of the pedal of each wheel. Push down on the pedal with your foot as far as the pedal goes down and the wheel locked. The front wheels will not move. Fig.4
2. To unlock: Place your foot on underside of pedal of the each wheel. Lift the pedal up with your foot as the pedal goes up. The front wheels will move. Fig.4A

Front wheel individual direction lock

1. To lock: Pull down this red lock until it "clicks" into a fully locked position, the front wheels will not swivel, the direction of the wheel is fixed and always face forward. Fig.4B
2. To unlock: Lift up this red lock, the front wheels direction is universal. Fig.4C

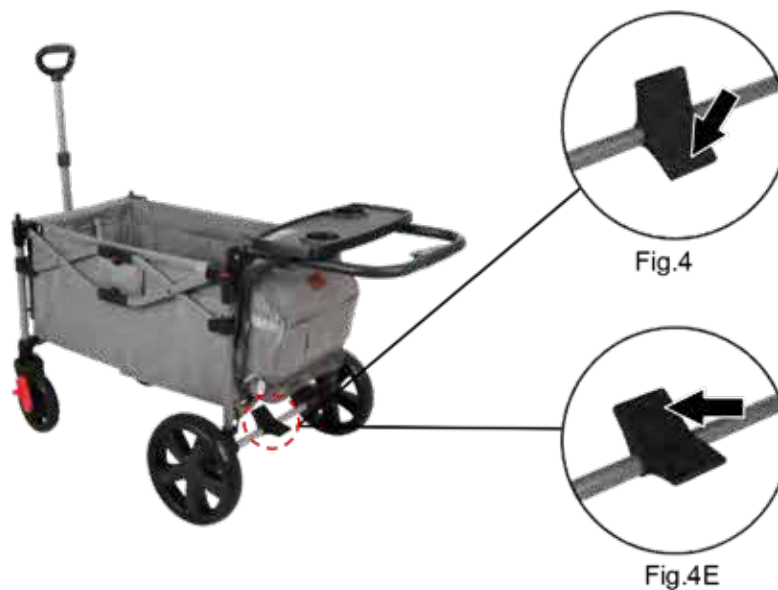

Locking rear axle

1. To lock: Step downward on the top of the pedal as far as the pedal will go. Make sure the pedal is fully depressed and that the rear wheels will not move. Fig.4D
2. To unlock: Place your foot on the pedal and press forward fully. The rear wheels will move. Fig.4E

USE OF HARNESS

WARNING! Before placing your child in or out of wagon, make sure the brake pedals are pressed down completely.



Fig.1A



Fig.1B



Fig.1C



Fig.1D



Fig.1E



Fig.1F



Fig.1G



Fig.1H



Fig.1I

Changing shoulder harness anchor points

1. The shoulder harness straps can be adjusted to fit your child. Has three(3) positions A.B.C. Fig.1E
2. Before adjusting the straps, let your child sit on the seating area, confirm which position fits your child best. For example: A child height 42" and weight 45LBS, we suggest to use position A.
3. To move shoulder harness straps to lower/higher position,undo snaps and the velcro closure behind the front/rear pocket, Fig.1A 1B. unbuckle the harness straps, Fig.1C. pull the straps back through fabric as shown. Fig.1D
4. Push shoulder harness straps through the anchor point slot, Fig.1E. undo snaps and velcro closure, Fig.1F. pull shoulder straps out then back, Fig.1G wrap the bar then clip as shown. Fig.1H

USE OF HARNESS

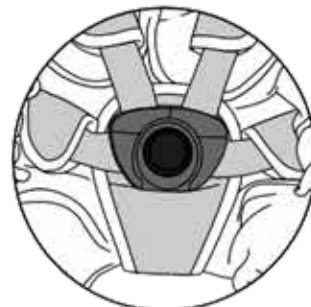
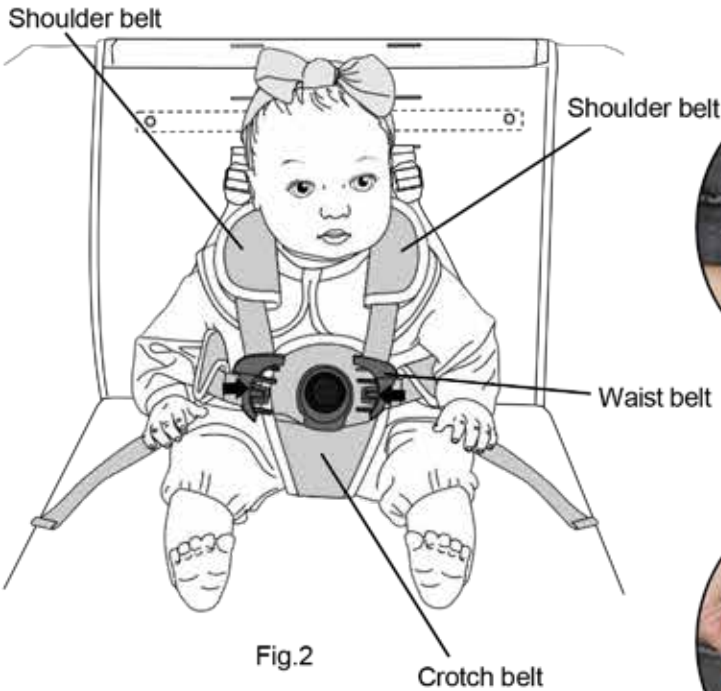

Fig.2E

Locking and unlocking the safety harness

1. Place your child in the wagon, Position the crotch belt between your child's legs. Fig.2
2. Pull shoulder belt over child's arm and shoulder, then pull waist belt over child's waist, fit these two together as one large male buckle. Fig.2A 2B.
3. Fasten the large male buckle to the female buckle on the crotch belt making sure you hear a "click" on both sides. Fig.2C. Fig.2D.
4. Check to make sure the safety harness is securely attached. Fig.2E

USE OF HARNESS



Fig.3A



Fig.3B

Unlock the safety harness

1. Press down on button to release the two fastening points. Fig.3A Fig.3B



Fig.4A

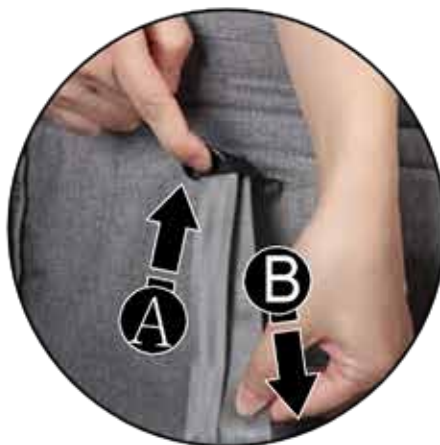

Fig.4B

Adjusting the length of safety harness

1. Both shoulder and waist belts are adjustable.
2. Pull the free end of the straps (A) to tighten the safety harness. Fig.4A
3. Lift the black buckle as shown and pull the straps (B) to loosen the safety harness. Fig.4B

DISASSEMBLY INSTRUCTIONS



Fig.1A



Fig.1B



Fig.1C

Remove wagon wheels

1. Remove rear wheels: Invert wagon, Press the lock continuously as shown, then take the rear wheel off. Fig.1A
2. Remove rear axle: press pin on each side, lift the rear axle up to remove from frame. Fig.1B
3. Remove front wheels: Press the lock continuously as shown, then take the front wheel off. Fig.1C



Fig.2A



Fig.2B



Fig.2C



Fig.2D



Fig.2E

Remove fabric

1. Turn the wagon on its side, undo underside velcro straps from frame. Fig.2A
2. Undo all buckles on the four corners. Fig.2B
3. Undo velcro flaps on the side. Fig.2C
4. Remove shoulder harness straps and waist harness straps from wagon frame. Fig.2D,2E

Note: Installing fabric just follow these steps in reverse.

CARE AND MAINTNEANCE

Frame and fabric care

1. Avoid prolonged exposure to direct sunlight as this may cause materials and fabric to fade.
2. Periodically wipe down plastic parts. Always dry any metallic parts to prevent it from getting rusty.
3. Regularly check the condition of the wheels.
4. Do not fold or store kids wagon if frame or fabric is wet. Do not store kids wagon in a damp environment.
5. Use a mild household soap with cold water.



Wash by hand in cold water



Do not bleach



Dry Flat



Do not iron



Do not dry clean

Customer Assistance And Questions

If you have any questions regarding the assembly or safe use of your product, Please contact us.

 www.everadvanced.com

 info@everadvanced.com

 [@everadvanced](https://www.facebook.com/everadvanced)

 [@everadvanced](https://www.instagram.com/everadvanced)