



INSTALLATION GUIDE

STEALTH FIGHTER FRONT BUMPER 22+/TOYOTA TUNDRA



PREPARATION

We recommend reading through the installation instructions in whole before performing the work.

- Disconnect the negative battery terminal. Park the vehicle on level ground and set the emergency brake.
- When button head bolts are being used, install the supplied washer on the nut side. Then, hold the bolt stationary and only turn the nut to tighten. Do not turn the bolt to tighten hardware assembly, unless otherwise noted.
- Anti-seize is recommended for all fasteners.

SKILL LEVEL

-Hard/Skilled

****This installation requires 2 people for best results****

TIME REQUIRED

- 4 hours for OEM Removal/Cutting/Bumper Install
- 1 Additional Hour to Wire Cube Lights

****Labor Rates are based on a vehicle with no pre-existing damage. Wiring labor is based on a standard wiring procedure with light switches installed in an easily accessible location. Custom light triggering or switch mounting location will result in a greater labor charge.****

INCLUDED IN KIT

- 6- Nylon Lock Nuts (1/2-13")
- 6- Hex Head Bolts (1/2-13 X 1 1/4")
- 12- Flat Washer (1/2")
- 12- Hex Head Bolt (3/8-16 x 1 1/4")
- 4- Nylon Lock Nuts (3/8-16")
- 16- Flat Washers (3/8")
- 8- 3m Double Sided Tape (1"x1")

TOOLS REQUIRED

- (Box end wrenches) 10mm, 17mm, 7/16, 9/16, 3/4
- (Sockets) 10mm, 17mm, 9/16, 3/4
- (Allen Wrenches) 5/32, 7/32
- Fastener remover or flathead screwdriver
- Jigsaw/Grinder
- Palm sander/sandpaper
- Razor blade/scissors
- Masking tape
- Sharpie
- Tape measure
- Zip ties



INSTALLATION GUIDE

STEALTH FIGHTER FRONT BUMPER

22+/TOYOTA TUNDRA

□ STEP 1

Using (masking tape and a tape measure) mark your cut before removing the bumper. See pictures below for layout. (Repeat on other side)

PREPARATION

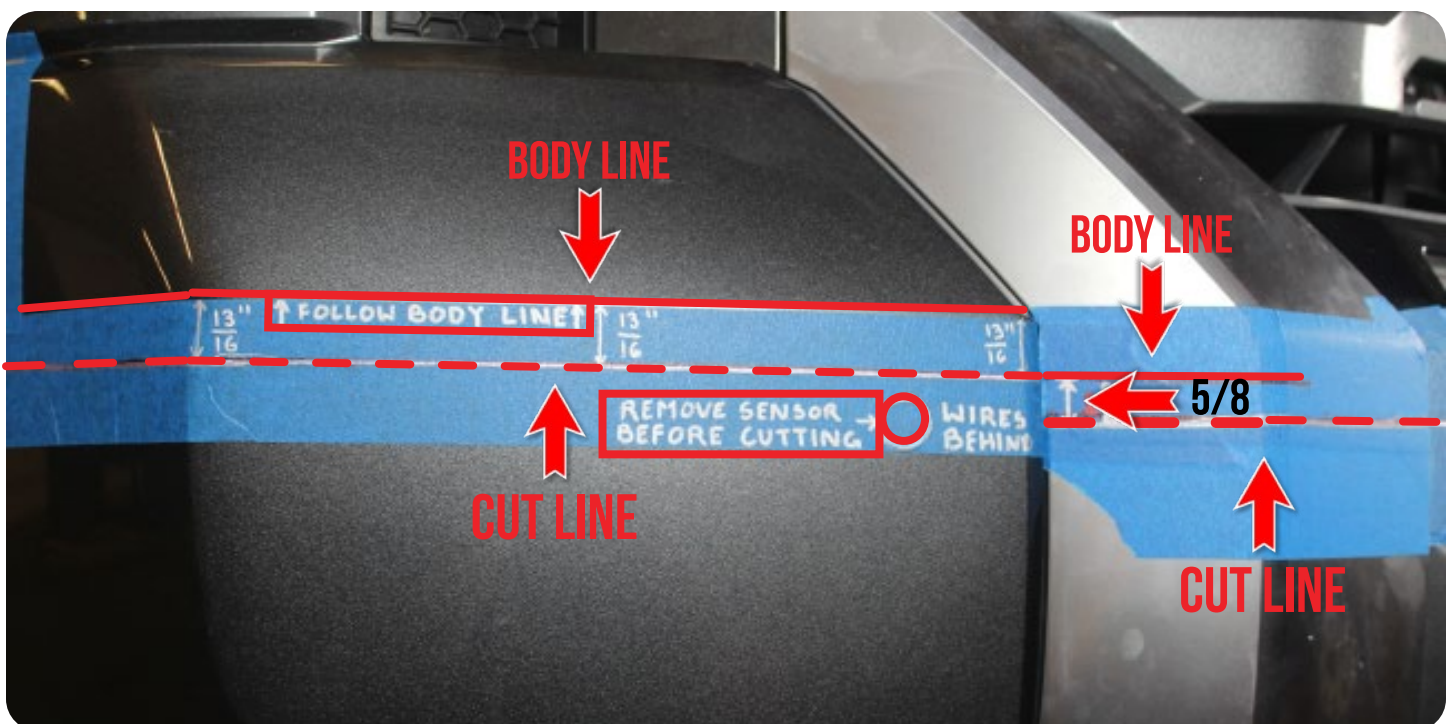



INSTALLATION GUIDE

STEALTH FIGHTER FRONT BUMPER
22+/TOYOTA TUNDRA

PREPARATION

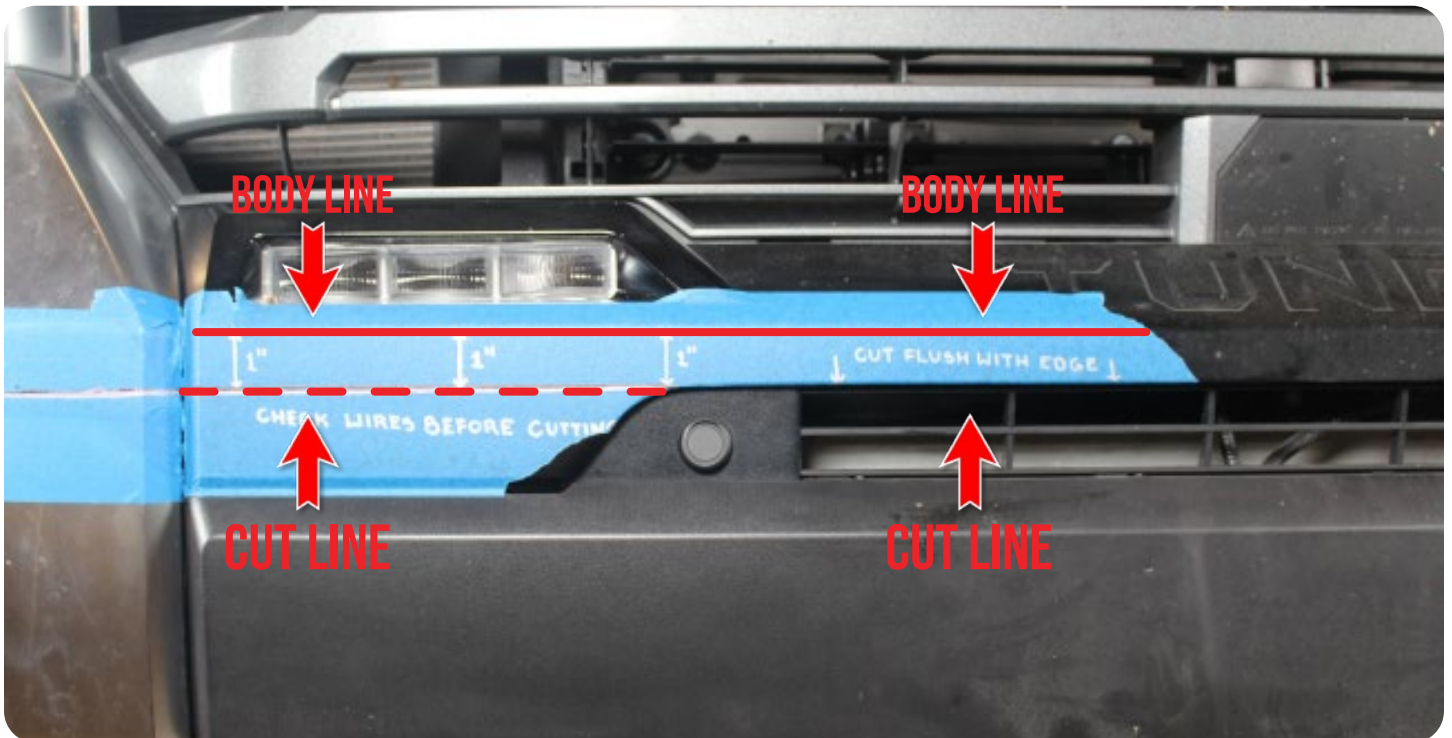
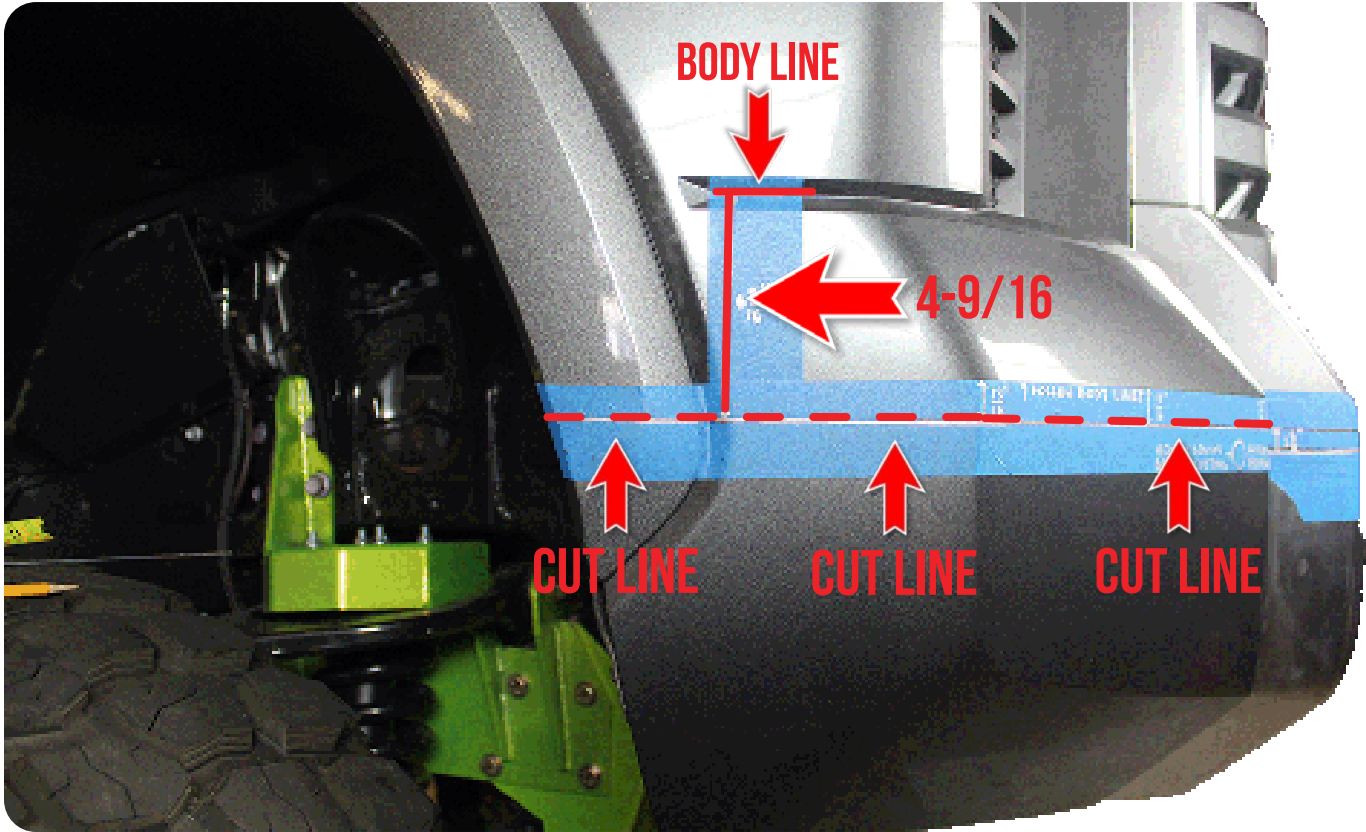



INSTALLATION GUIDE

STEALTH FIGHTER FRONT BUMPER

22+/TOYOTA TUNDRA

□ STEP 2

Remove the 4x bolts on top of the grill using a (10mm socket).

REMOVAL

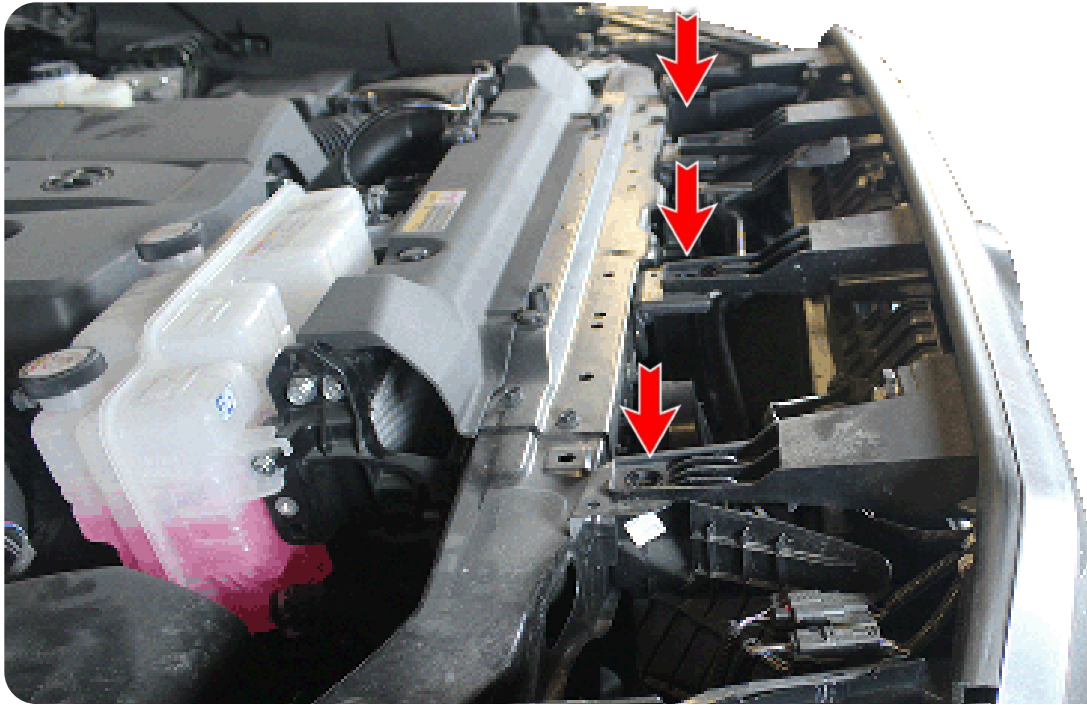

STEALTH FIGHTER FRONT BUMPER

22+/TOYOTA TUNDRA

□ STEP 3

Unplug the 3x wiring harness plugs by depressing and pulling.

REMOVAL





INSTALLATION GUIDE

STEALTH FIGHTER FRONT BUMPER

22+/TOYOTA TUNDRA

STEP 4

Remove the 2x support mount bolts from underneath the bumper using a (10mm socket).

REMOVAL

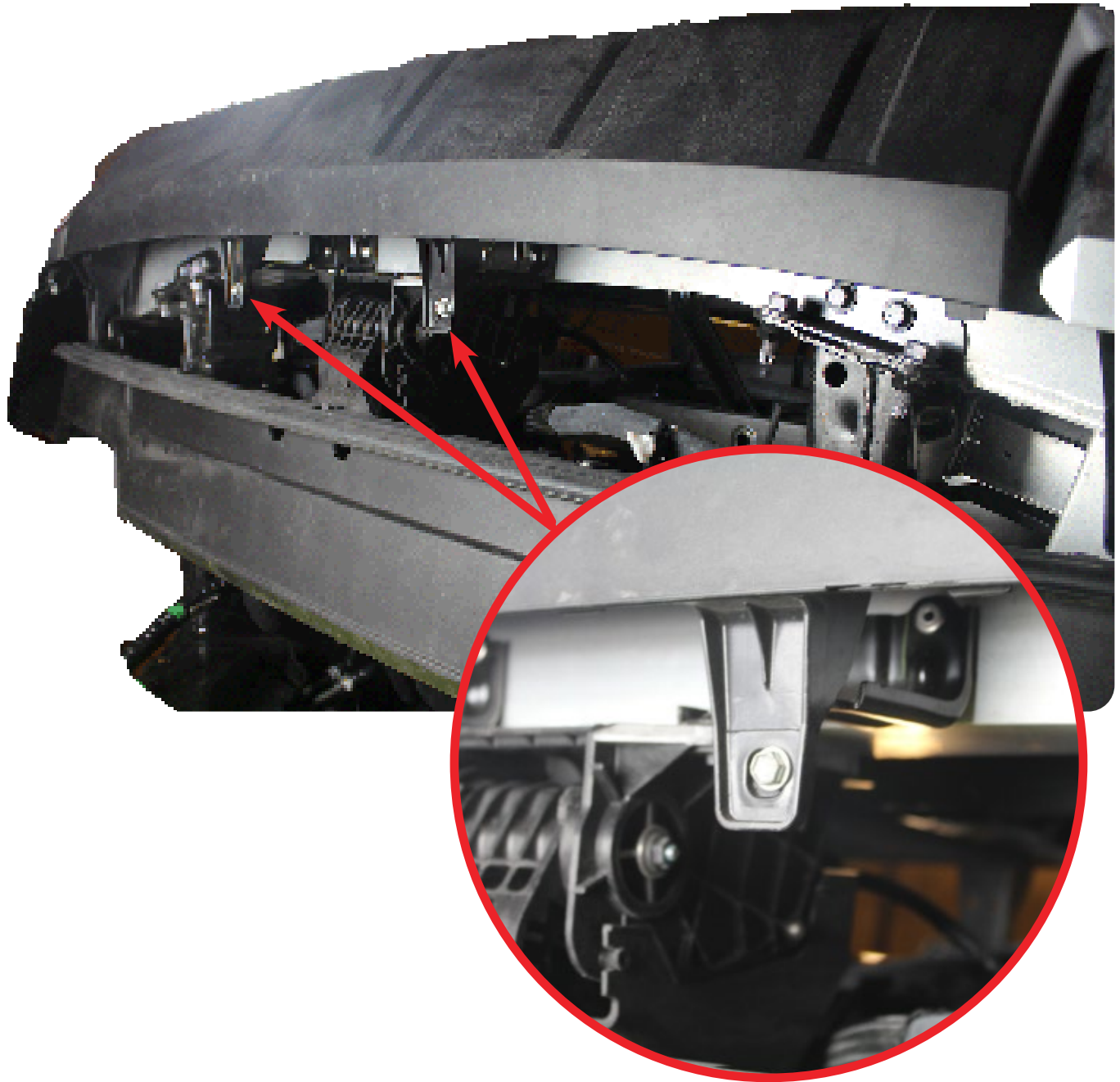

STEALTH FIGHTER FRONT BUMPER

22+/TOYOTA TUNDRA

□ STEP 5

Inside the wheel well, remove the 4x bolts holding the trim by using a (10mm socket). After, pop both trim and grill off by pulling towards you. You can now remove the grill.

REMOVAL

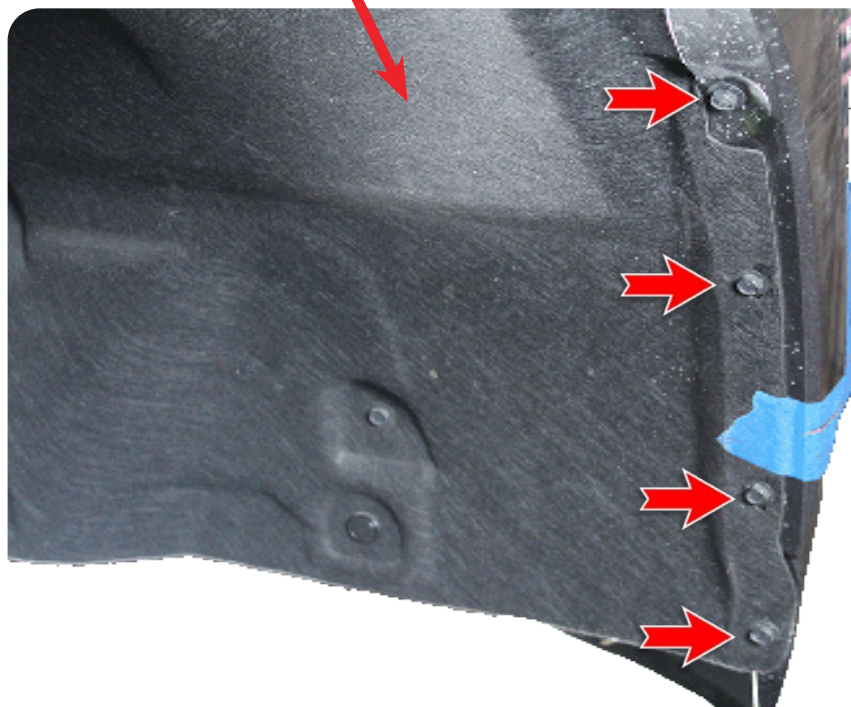
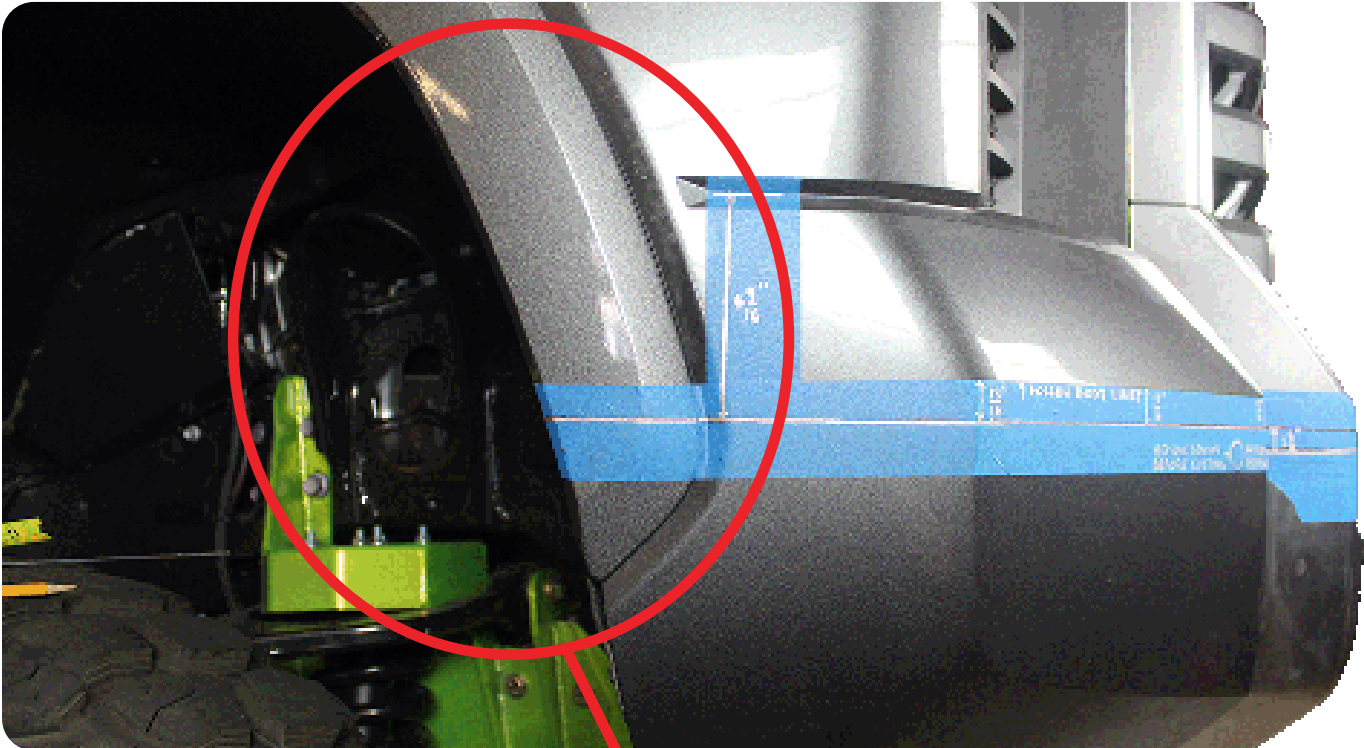

STEALTH FIGHTER FRONT BUMPER 22+/TOYOTA TUNDRA

REMOVAL



STEALTH FIGHTER FRONT BUMPER

22+/TOYOTA TUNDRA

□ STEP 6

Unplug the air dam motor by depressing and pulling.

REMOVAL

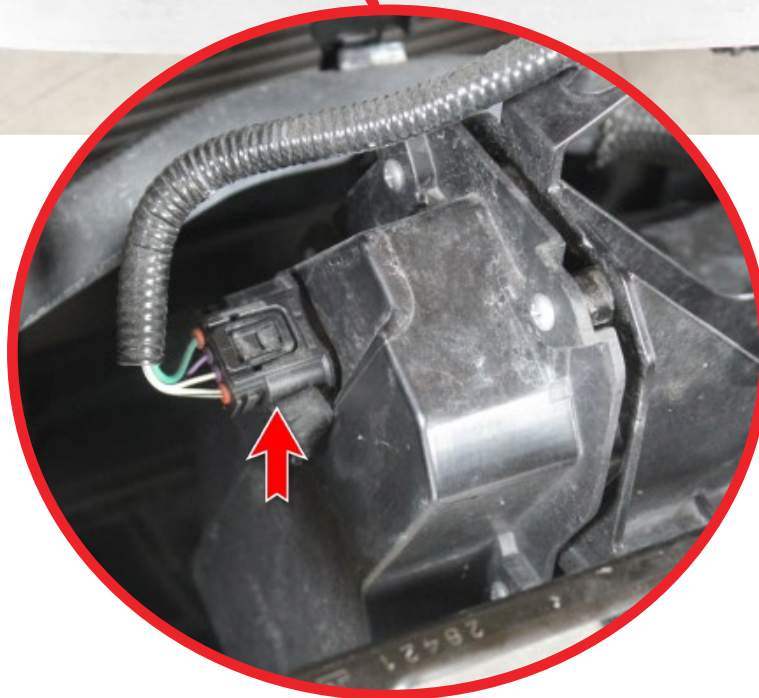
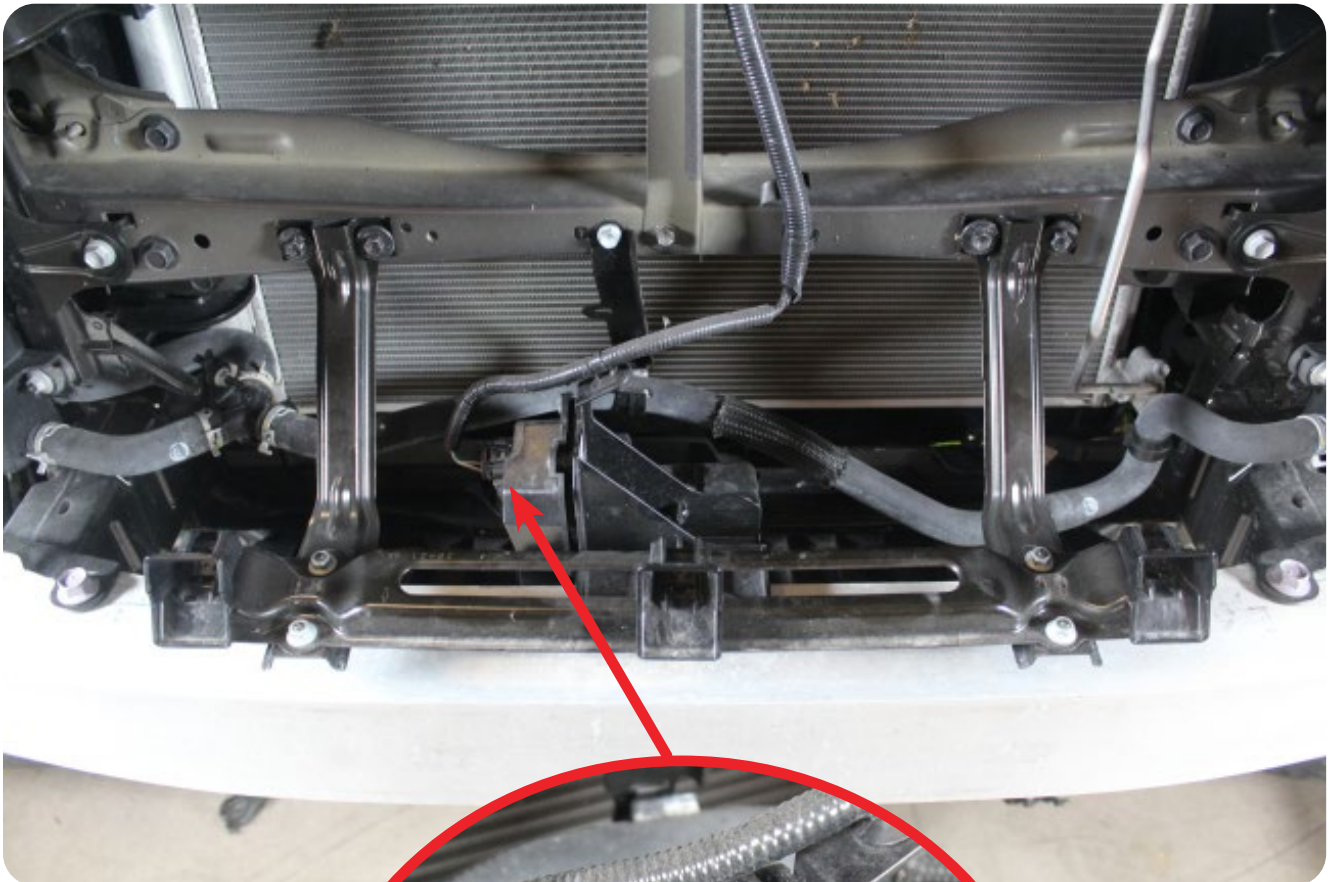

STEALTH FIGHTER FRONT BUMPER

22+/TOYOTA TUNDRA

□ STEP 7

Remove the 4x aluminum crash bar bolts on top and bottom by using a (17mm socket).

REMOVAL





INSTALLATION **GUIDE**

STEALTH FIGHTER FRONT BUMPER

22+/TOYOTA TUNDRA

REMOVAL

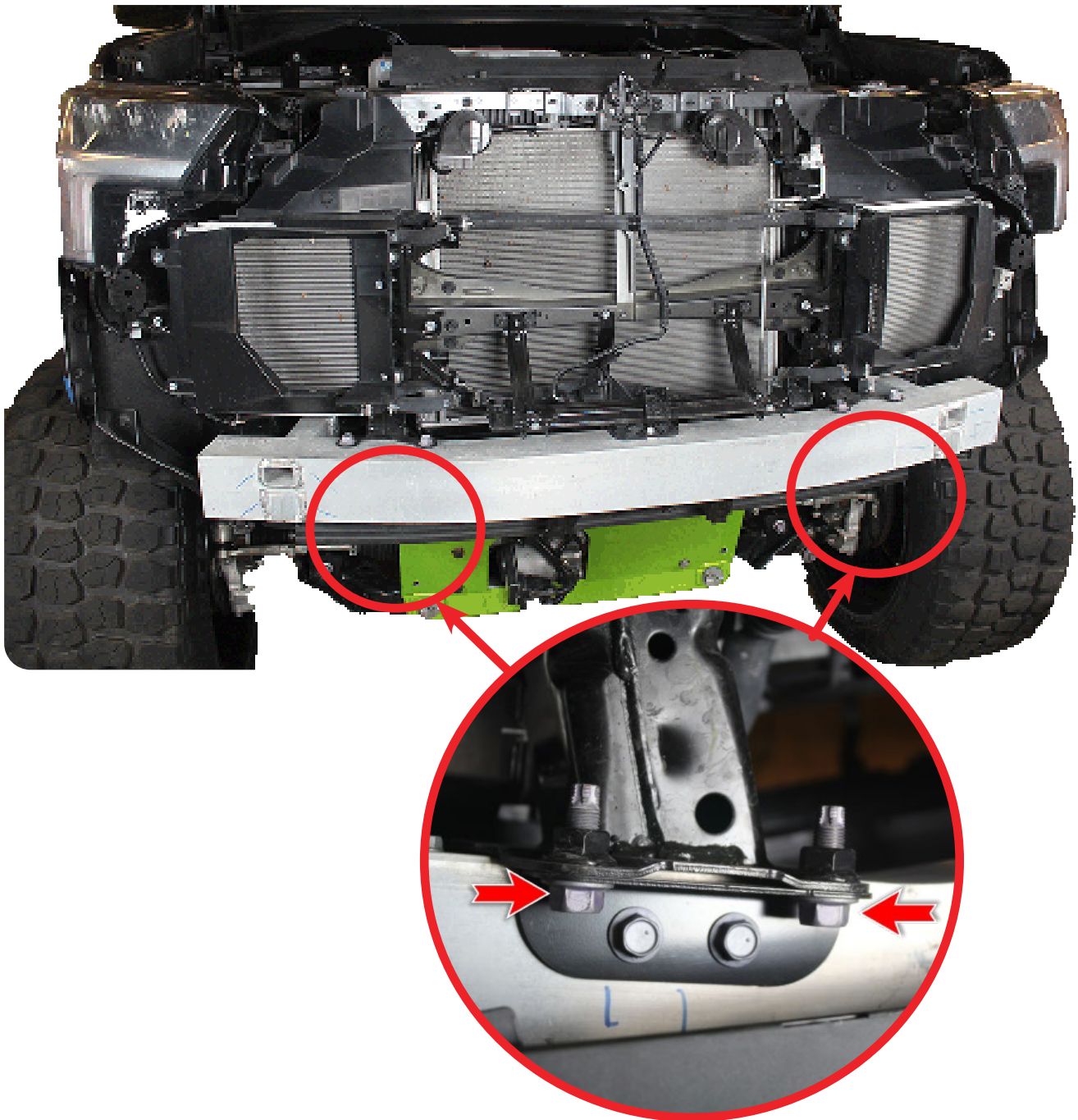

STEALTH FIGHTER FRONT BUMPER

22+/TOYOTA TUNDRA

❑ STEP 8

Remove the air dam motor by using a (10mm socket). Remove the 6x bolts shown below.

REMOVAL

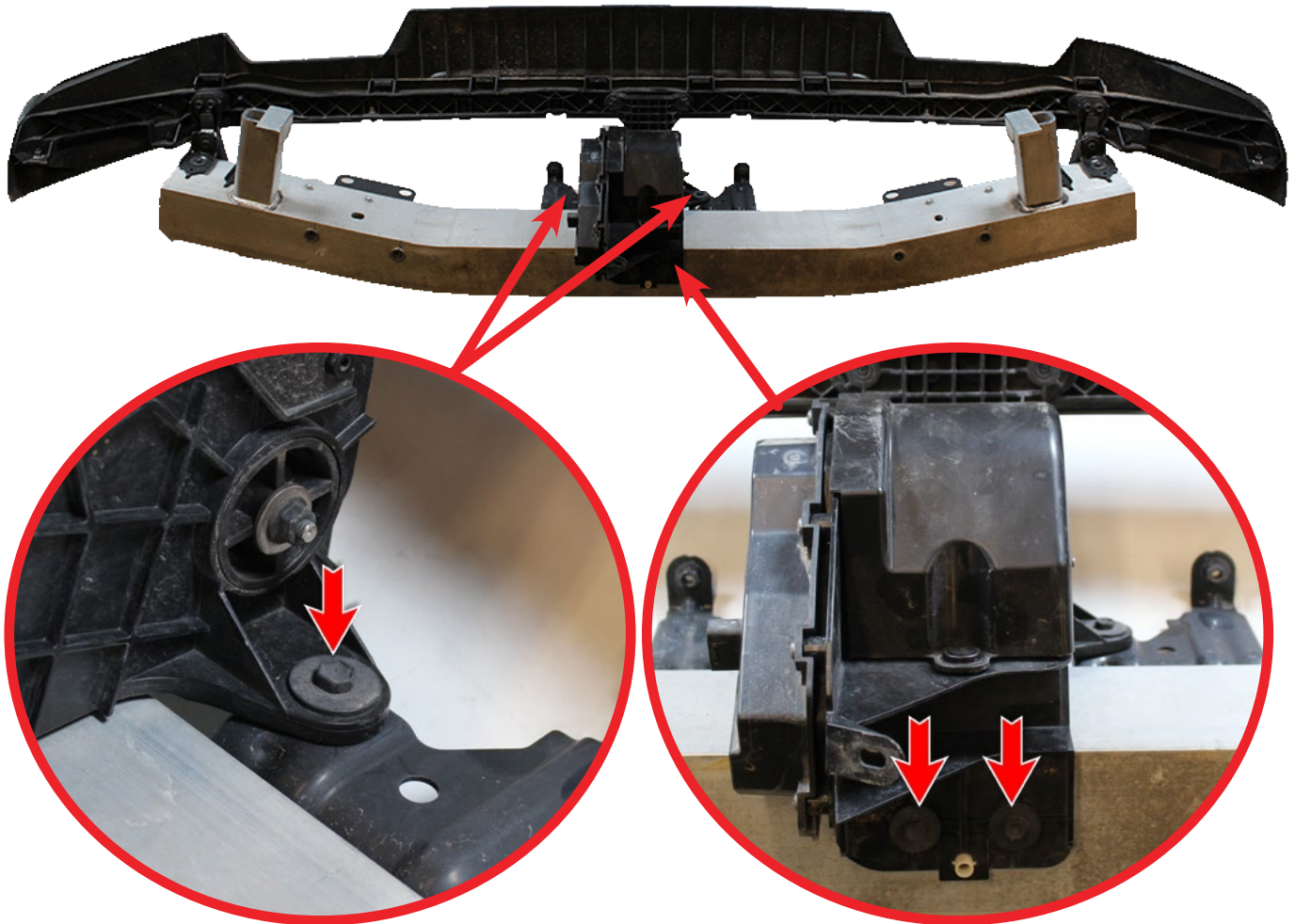

STEALTH FIGHTER FRONT BUMPER

22+/TOYOTA TUNDRA

□ STEP 9

Flip the air dam over and remove the 2x bolts from the bottom as shown below using a (10mm socket).

REMOVAL

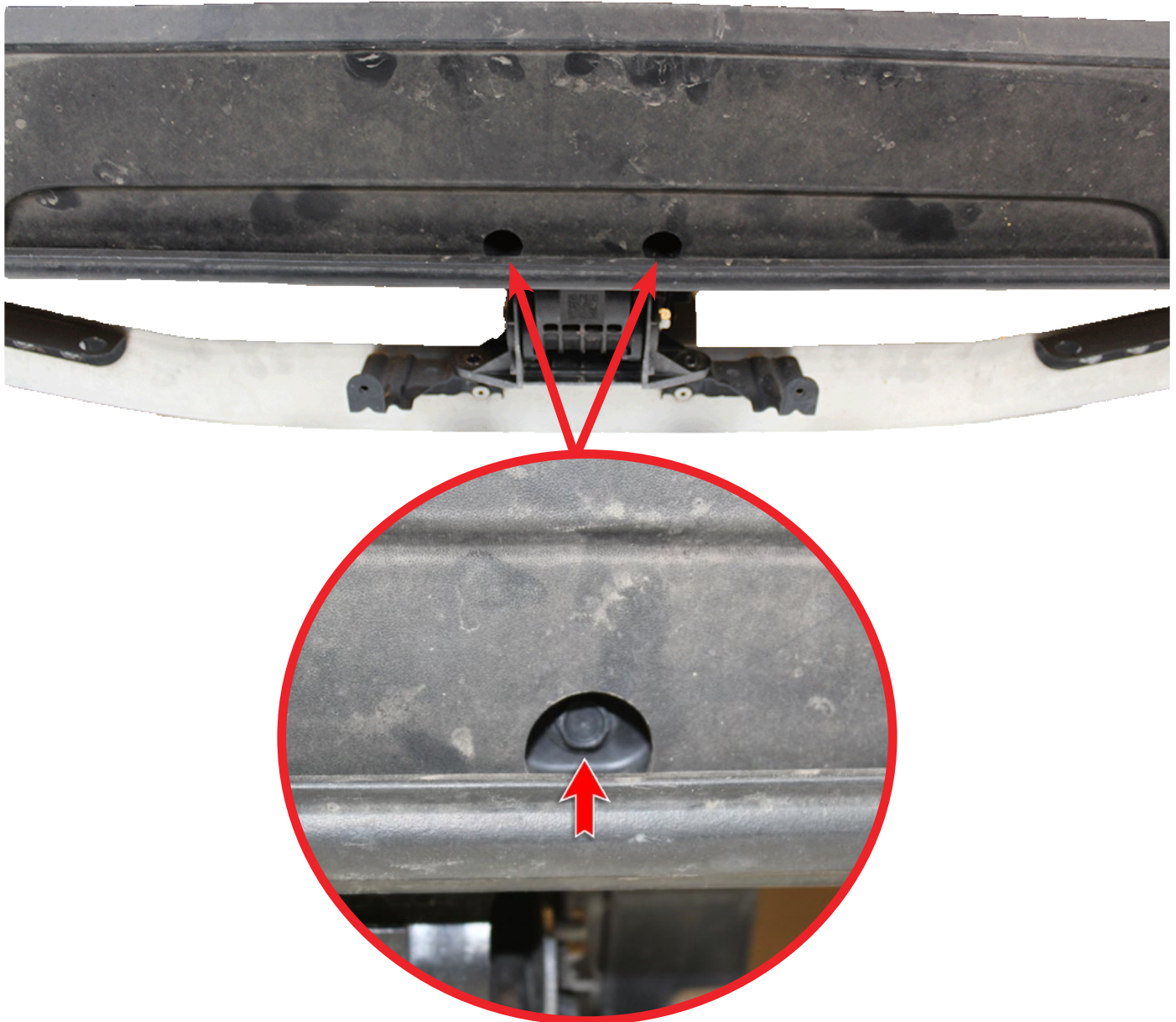

STEALTH FIGHTER FRONT BUMPER

22+/TOYOTA TUNDRA

□ STEP 10

After the air dam motor has been removed, cut along the lines as shown below using a (cutoff wheel).

REMOVAL

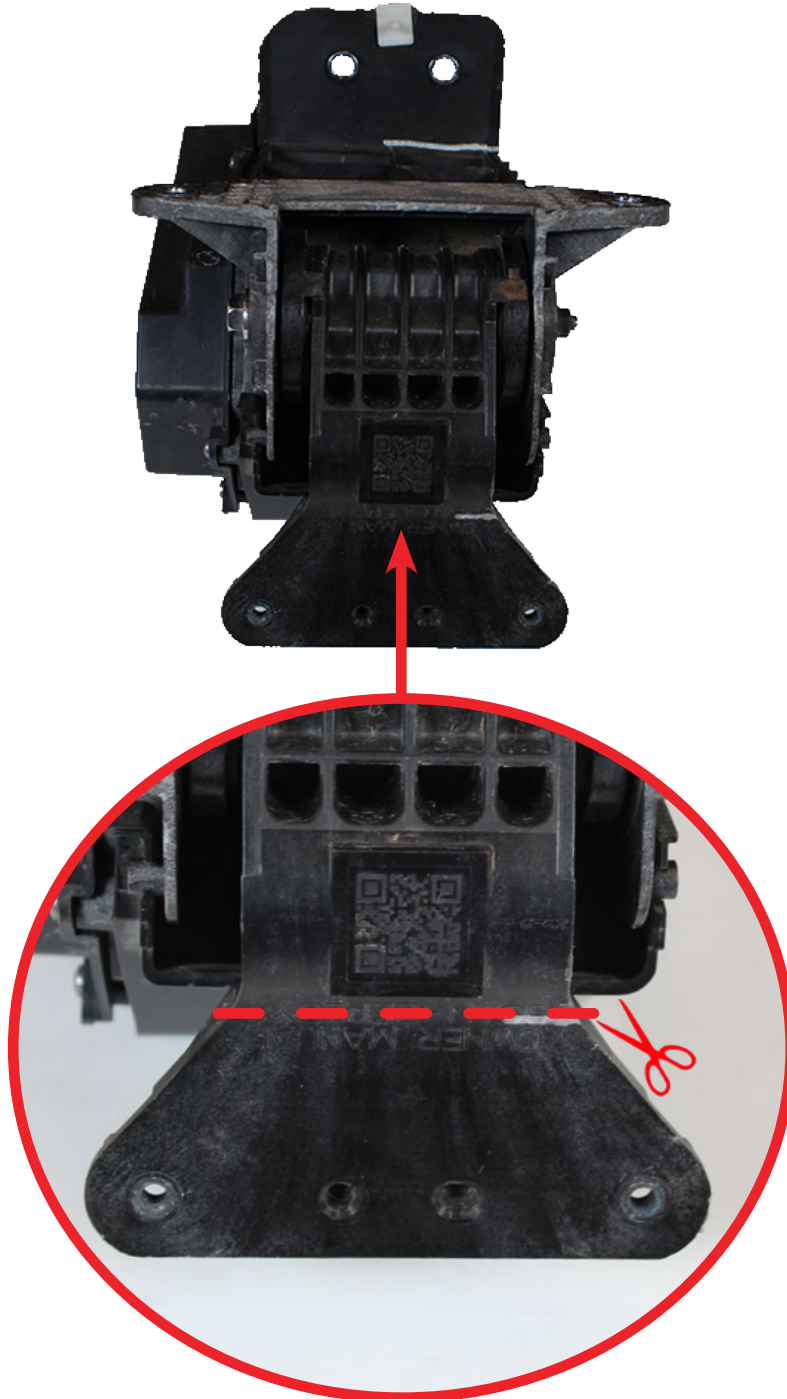



INSTALLATION GUIDE

STEALTH FIGHTER FRONT BUMPER
22+/TOYOTA TUNDRA

REMOVAL

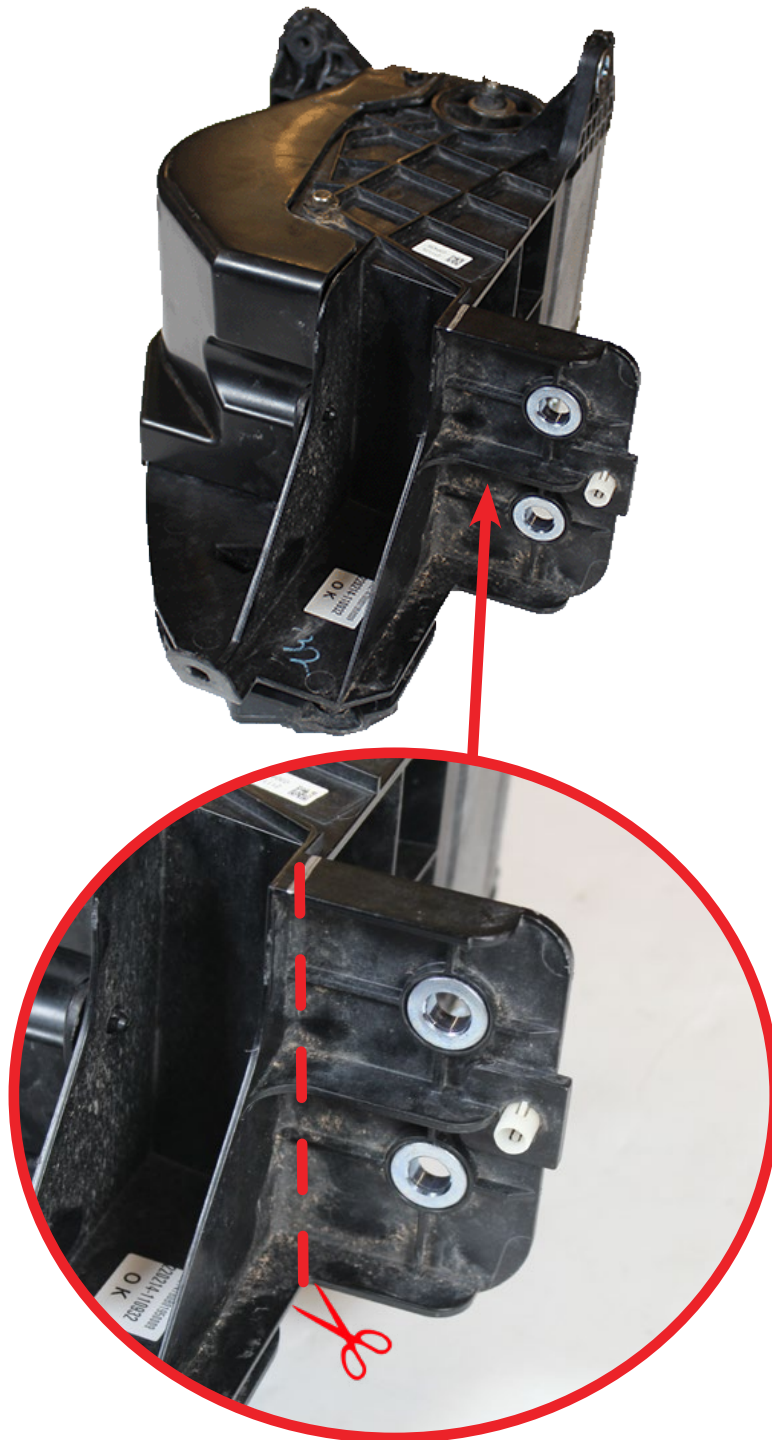

STEALTH FIGHTER FRONT BUMPER

22+/TOYOTA TUNDRA

❑ STEP 11

Remove one out of the four stock bolts shown below using a (10mm socket).

REMOVAL

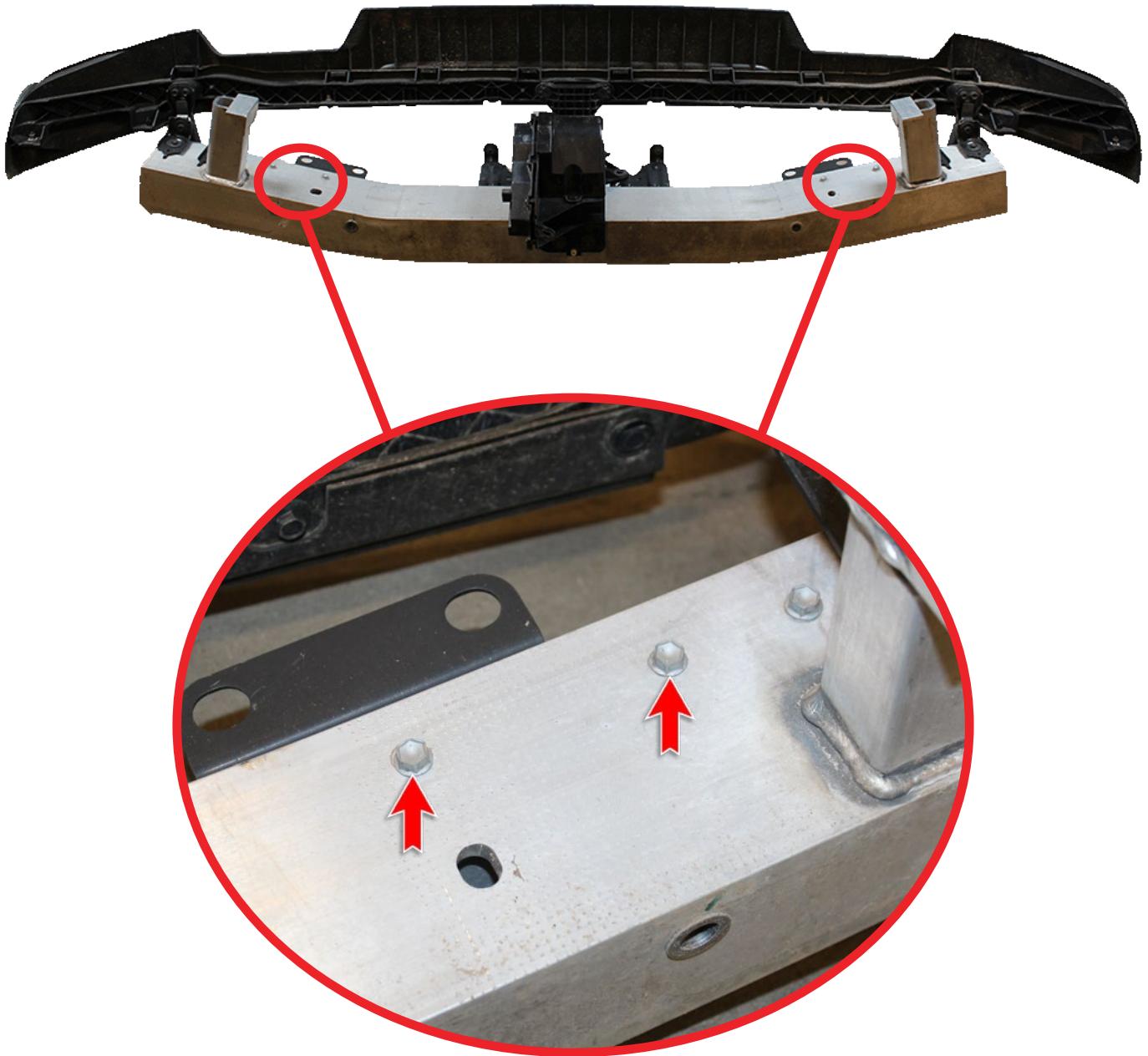

STEALTH FIGHTER FRONT BUMPER

22+/TOYOTA TUNDRA

STEP 12

Using the stock bolt taken from **step 11**, install the air dam motor bracket in the existing threaded holes shown below using a (10mm socket).

INSTALLATION

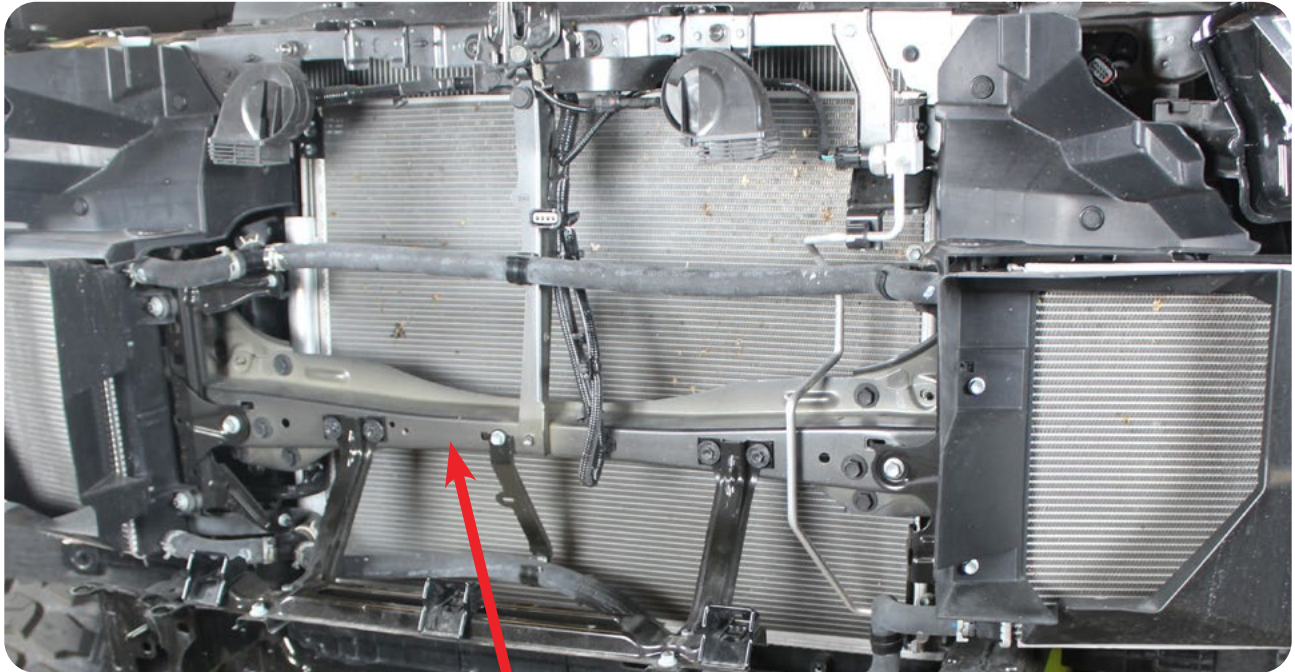

STEALTH FIGHTER FRONT BUMPER

22+/TOYOTA TUNDRA

STEP 13

Install the air dam motor using the provided 3/8" button head bolt, washer, and nylon lock nut using a (7/32 allen) and a (9/16 wrench). And the provided 1/4" button head bolt, washer, and nylon lock nut using a (5/32 allen) and a (7/16 wrench).

INSTALLATION

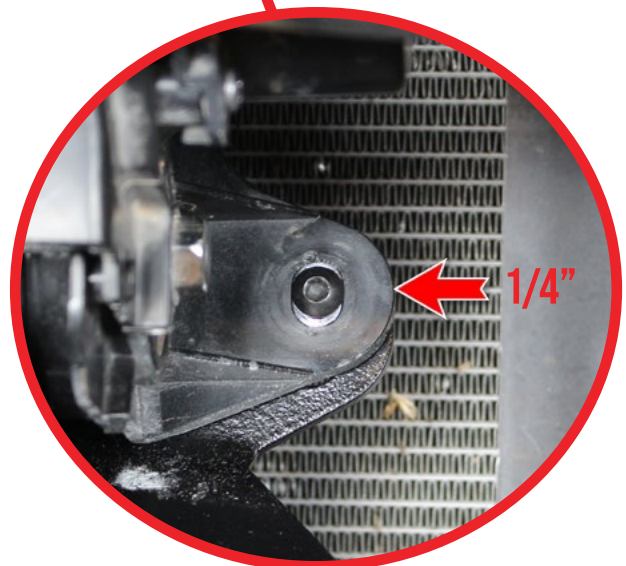
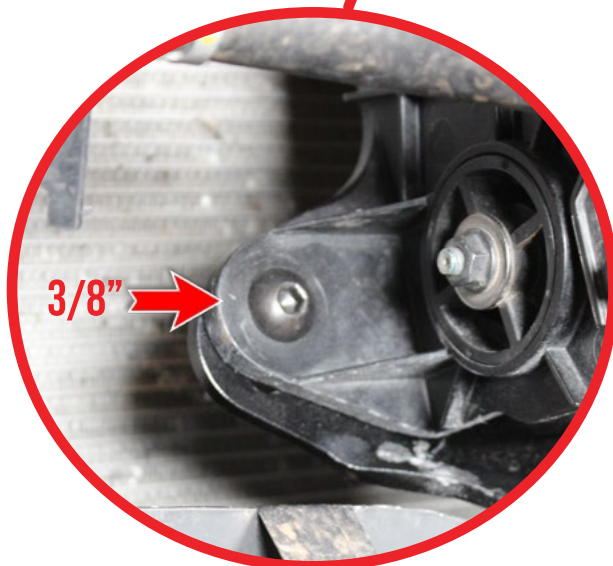
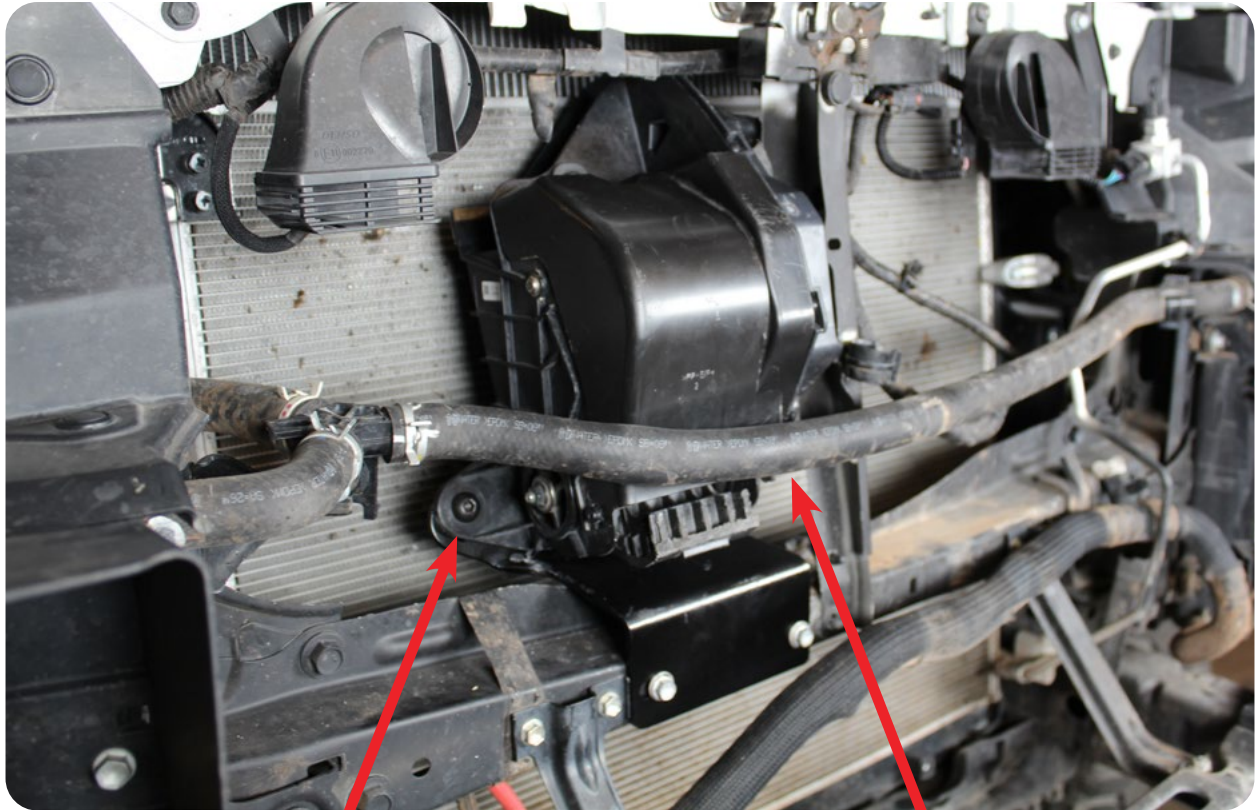

STEALTH FIGHTER FRONT BUMPER

22+/TOYOTA TUNDRA

□ STEP 14

Keep the coolant line in front of the motor and plug in your air dam motor before re-installing your grill.

INSTALLATION

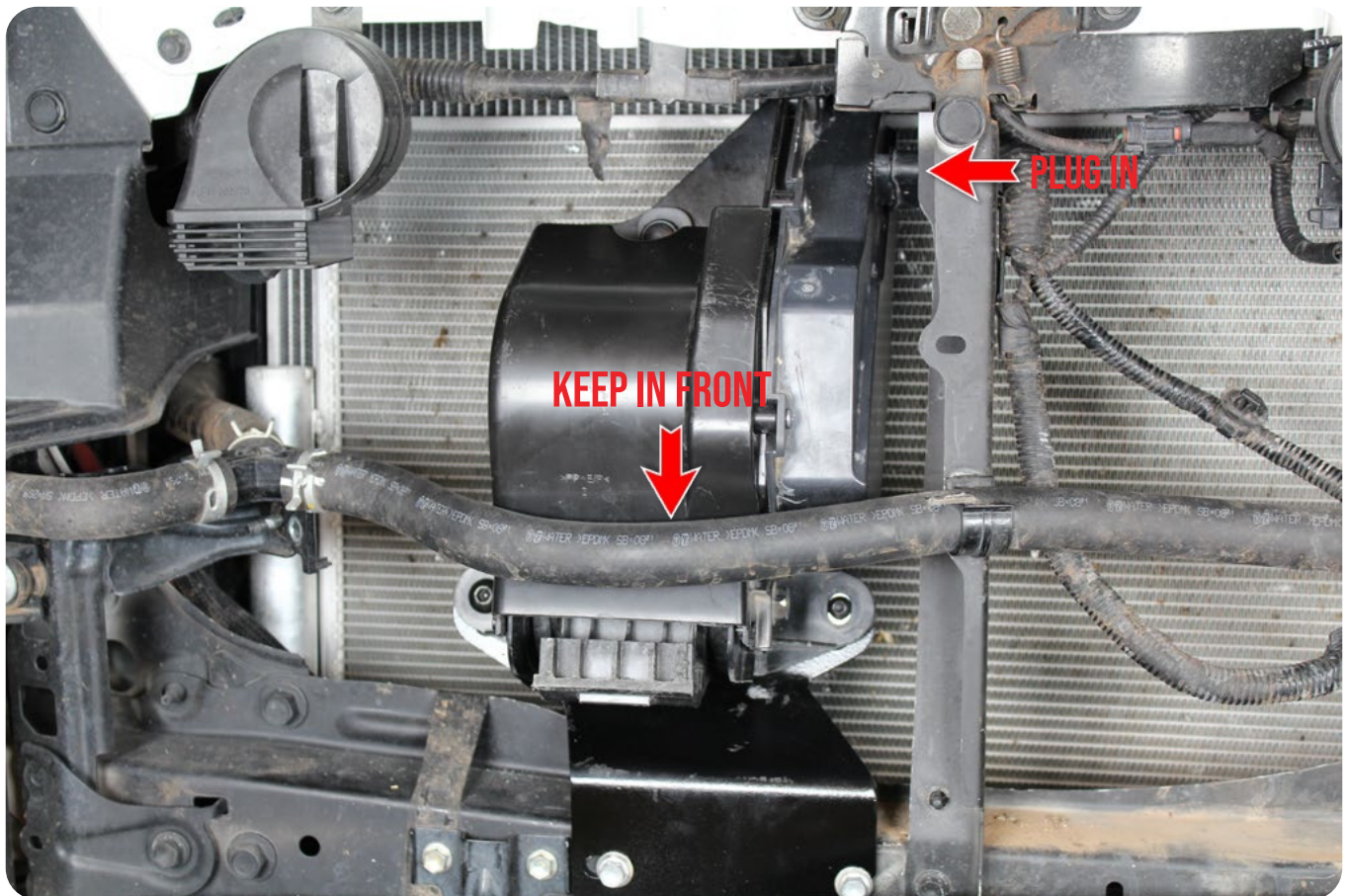

STEALTH FIGHTER FRONT BUMPER

22+/TOYOTA TUNDRA

□ STEP 15

Release parking sensors from bezel. ****DO NOT pry tabs hard due to breakage****

REMOVAL

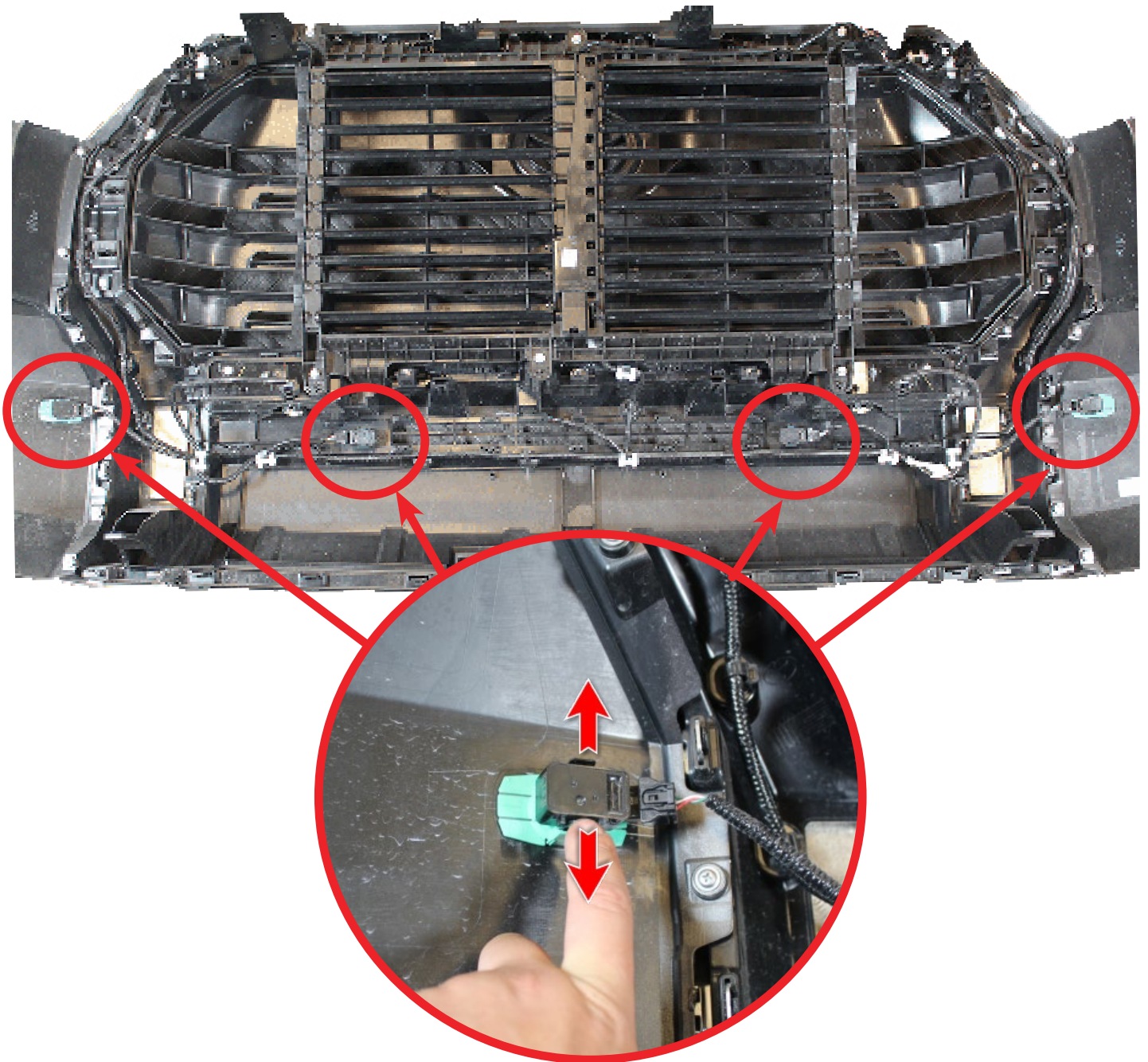

STEALTH FIGHTER FRONT BUMPER

22+/TOYOTA TUNDRA

□ STEP 16

Using a (fastener remover/flathead screwdriver) remove the key less entry antenna and all of the wire loom clips. ****Zip tie the sensor towards the top of the grill out of the way before re-install****

REMOVAL

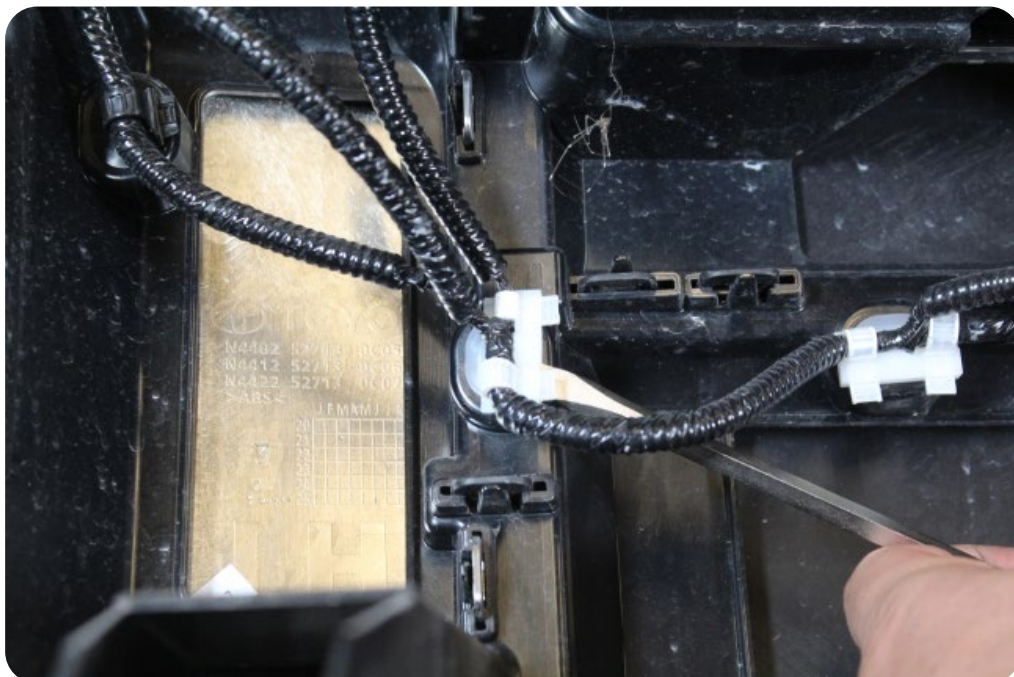
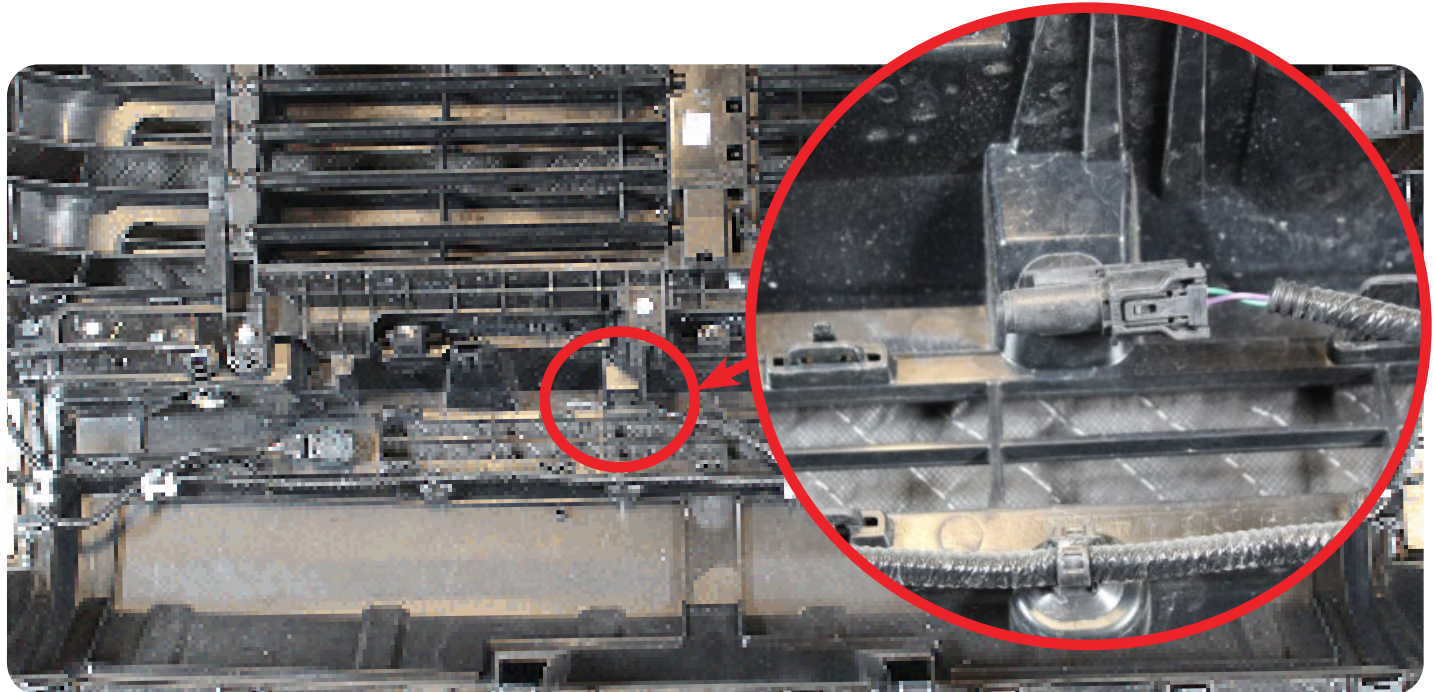

STEALTH FIGHTER FRONT BUMPER

22+/TOYOTA TUNDRA

□ STEP 17

Using a (flathead screwdriver) remove the sensor bezels. ****Be careful not to break tabs on top****

REMOVAL





INSTALLATION GUIDE

STEALTH FIGHTER FRONT BUMPER

22+/TOYOTA TUNDRA

STEP 18

Install the grill back onto the truck and cut along the lines made from step 1 using a (jigsaw). ****You can clean up the cut by using a palm sander or sandpaper****



STEALTH FIGHTER FRONT BUMPER

22+/TOYOTA TUNDRA

□ STEP 19

Install the winch mount by loosening the sway bar brackets for the bottom mounting holes using a (17mm socket). You will slip the mount above the bracket as shown on page 25 and reinstall with stock bolts. ****DO NOT remove the bracket completely****

INSTALLATION

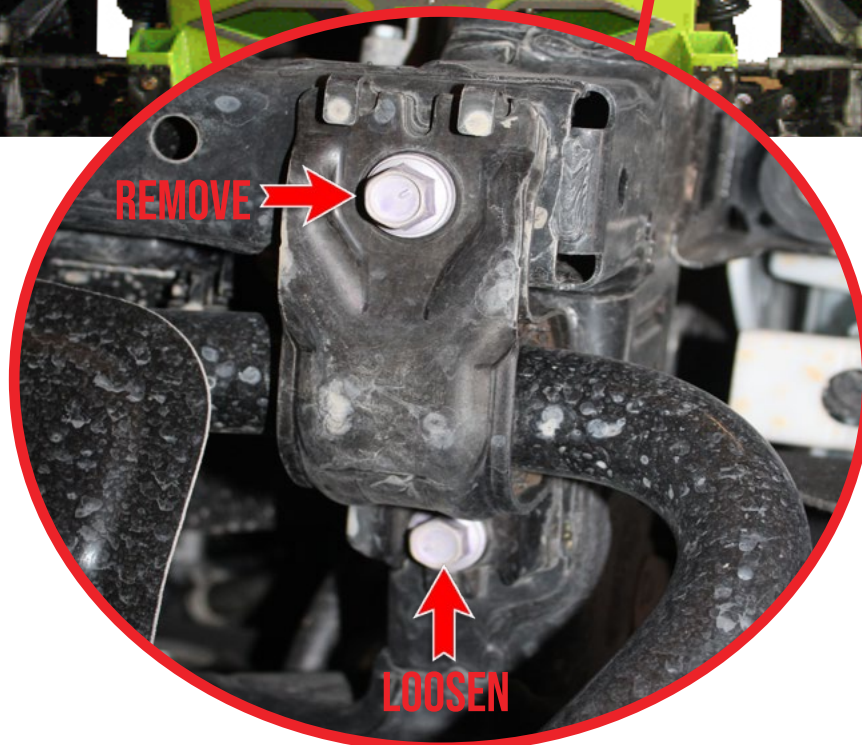



INSTALLATION GUIDE

STEALTH FIGHTER FRONT BUMPER

22+/TOYOTA TUNDRA

INSTALLATION

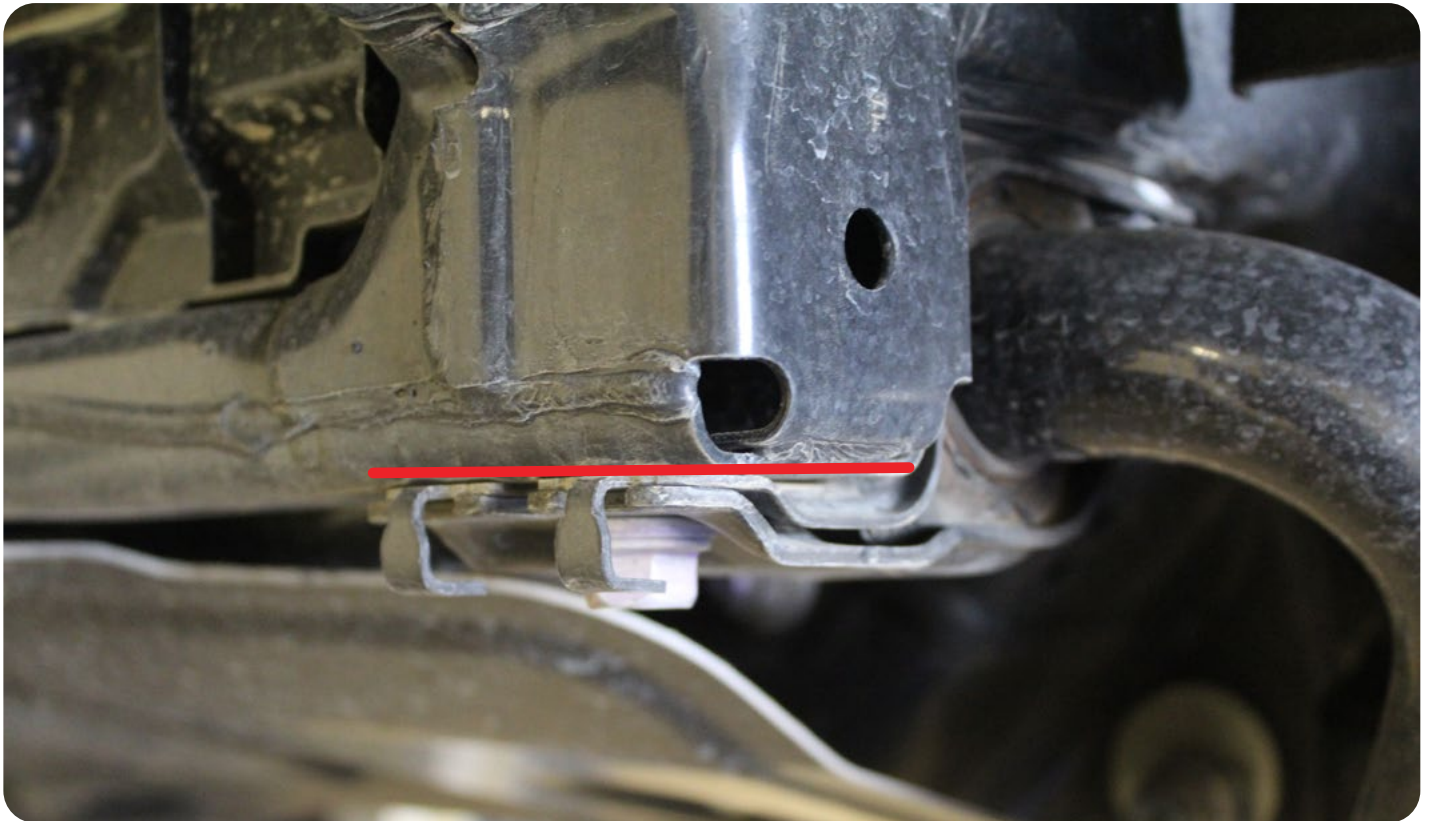



INSTALLATION GUIDE

STEALTH FIGHTER FRONT BUMPER

22+/TOYOTA TUNDRA

□ STEP 20

Next install the provided 3/8 bolts, nylon lock nuts, and washers on the middle hole by using a (9/16 socket and 9/16 wrench). Then install the provided 1/2" bolts, nylon lock nuts, and washers on the top hole and bottom using a (3/4 socket) and a (3/4 wrench).

INSTALLATION

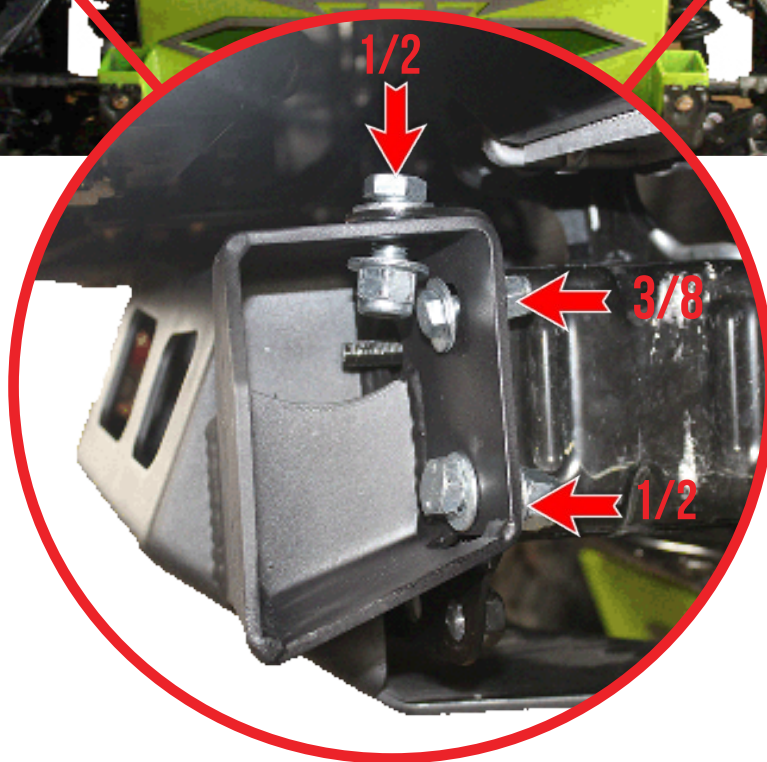
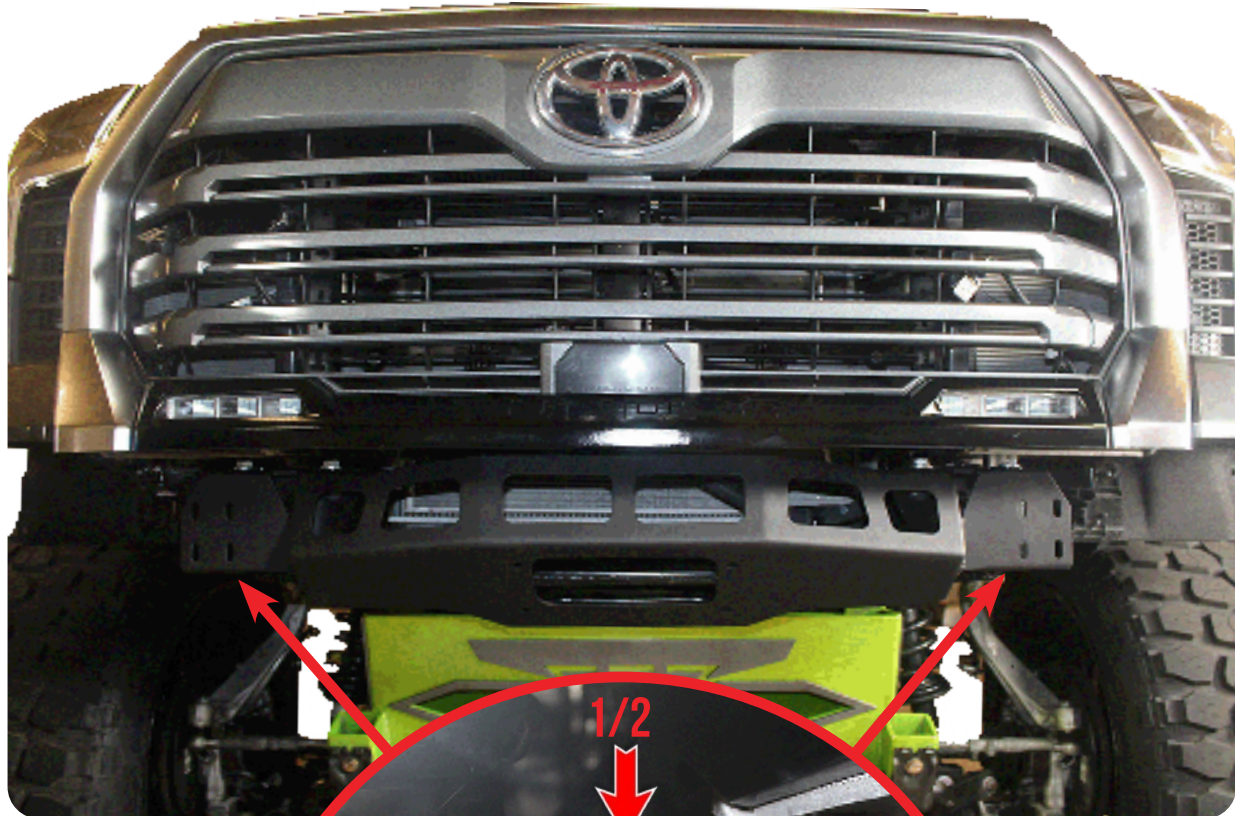

STEALTH FIGHTER FRONT BUMPER

22+/TOYOTA TUNDRA

INSTALLATION

STEP 21

Remove double sided tape from the bezel until the surface is clear of residue.

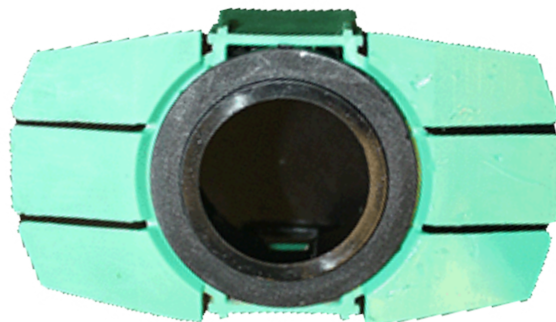

STEALTH FIGHTER FRONT BUMPER

22+/TOYOTA TUNDRA

INSTALLATION

□ STEP 22

Install 3m double sided tape to each side of the bezel wings and trim excess with a (razor blade).

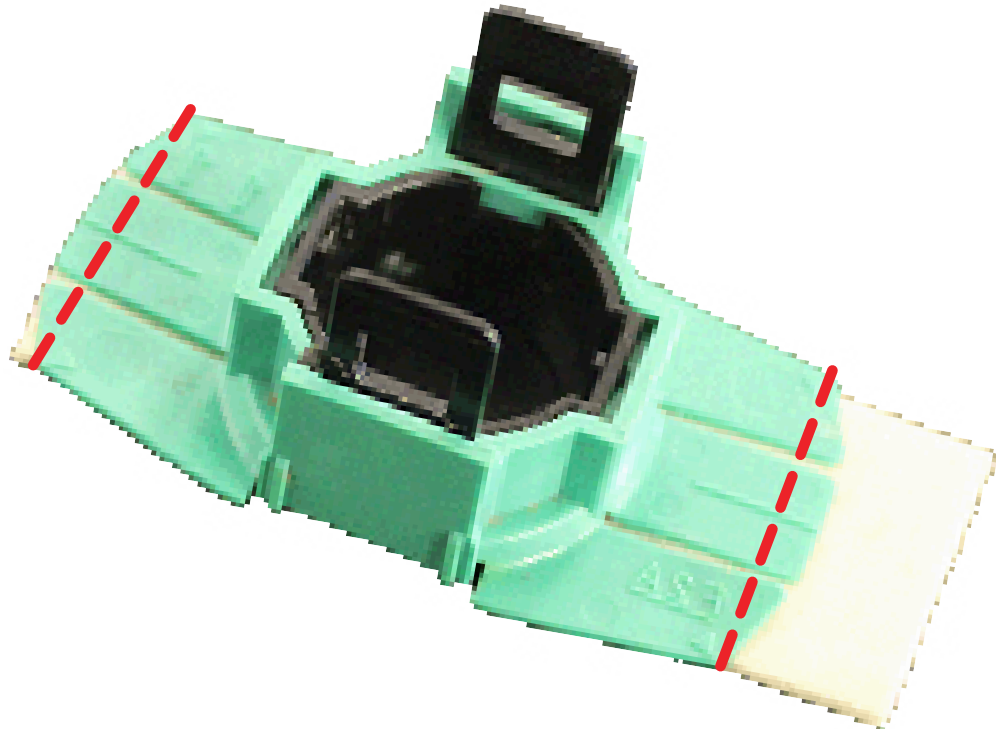
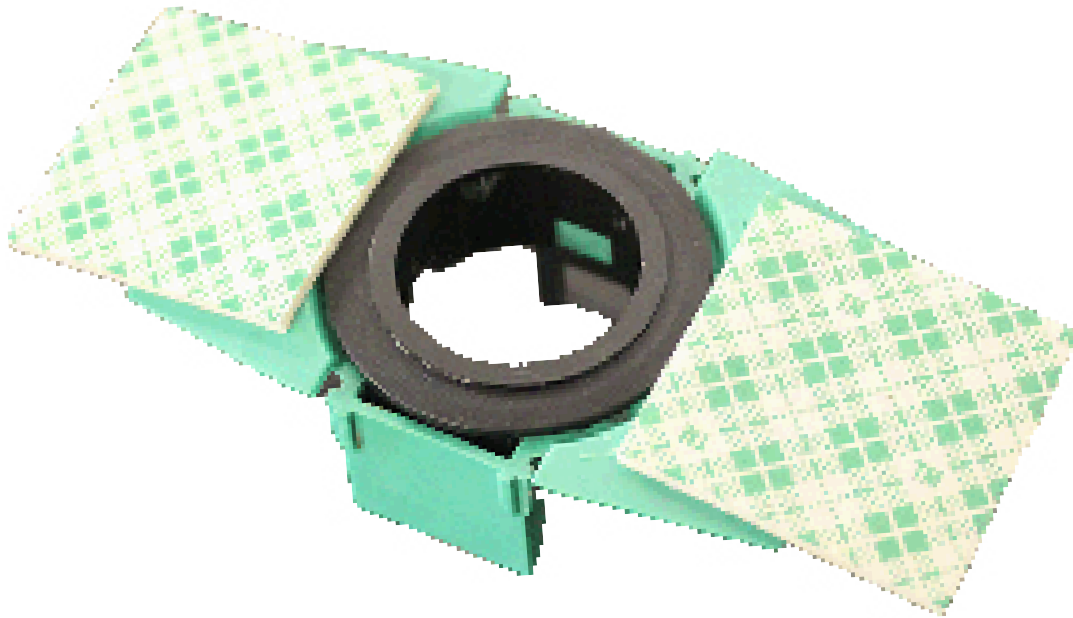

STEALTH FIGHTER FRONT BUMPER

22+/TOYOTA TUNDRA

□ STEP 23

Place the sensor bezels in the orientation provide in the pictures below.

INSTALLATION

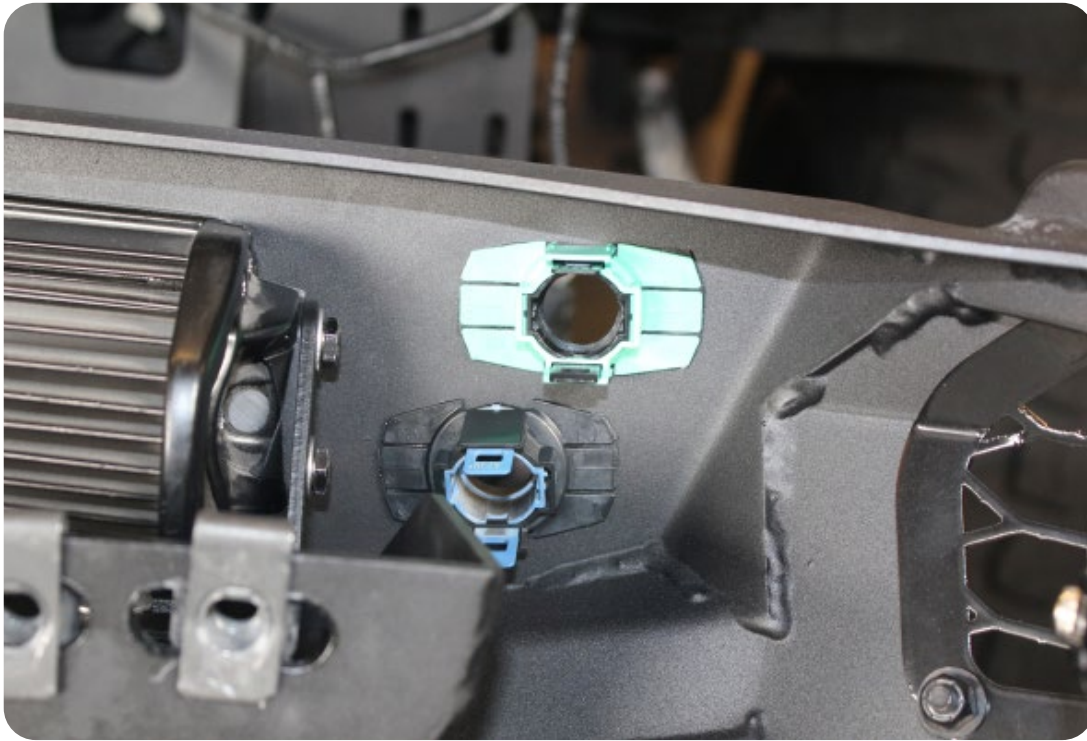



INSTALLATION GUIDE

STEALTH FIGHTER FRONT BUMPER

22+/TOYOTA TUNDRA

STEP 24

Install the provided 3/8 nut clips. (Repeat on other side)

INSTALLATION

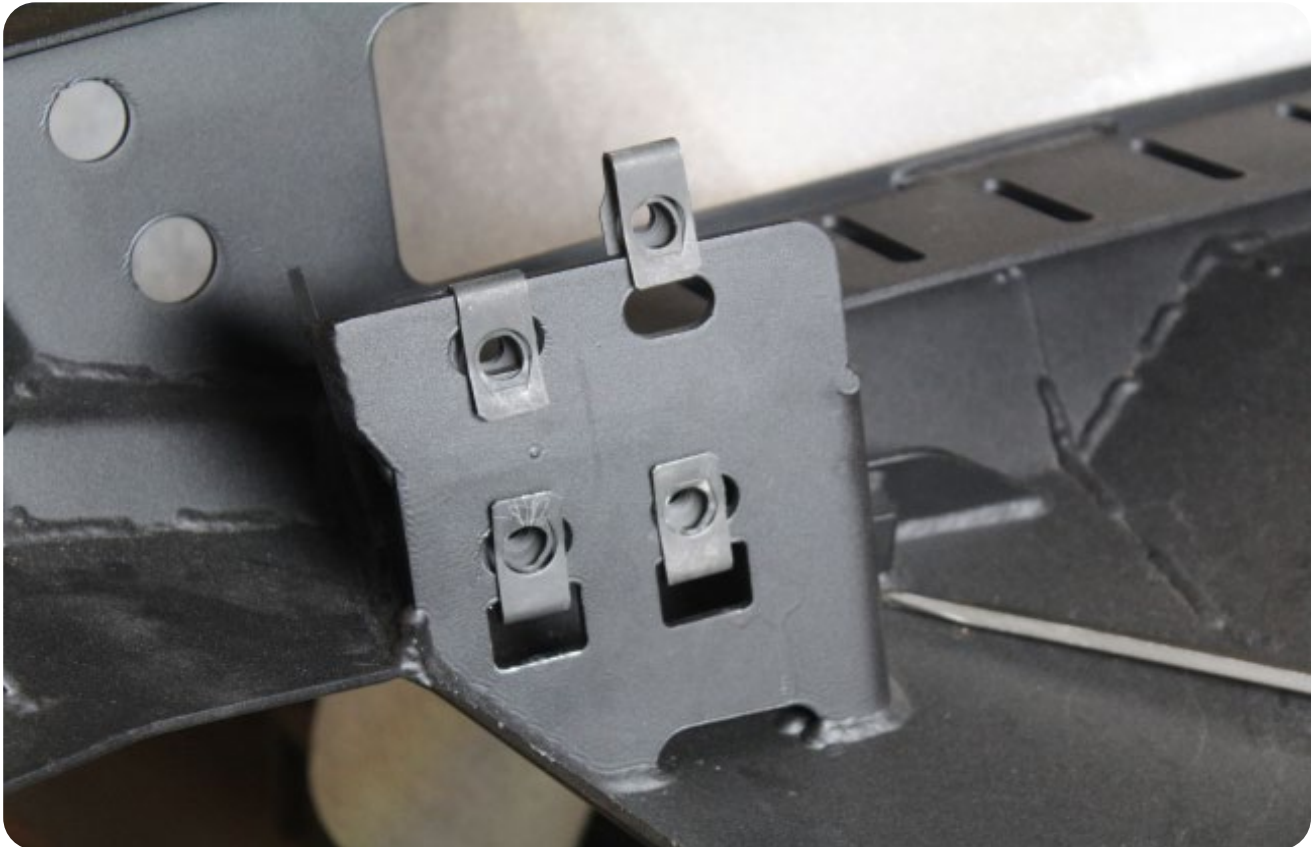



INSTALLATION GUIDE

STEALTH FIGHTER FRONT BUMPER

22+/TOYOTA TUNDRA

□ STEP 25

Remove the zip ties you used in **step 9** and let the wire harness hang before installing the bumper.

INSTALLATION





INSTALLATION GUIDE

STEALTH FIGHTER FRONT BUMPER

22+/TOYOTA TUNDRA

□ STEP 26

Cut the liner inside the wheel well using a (razor blade/scissors).

INSTALLATION

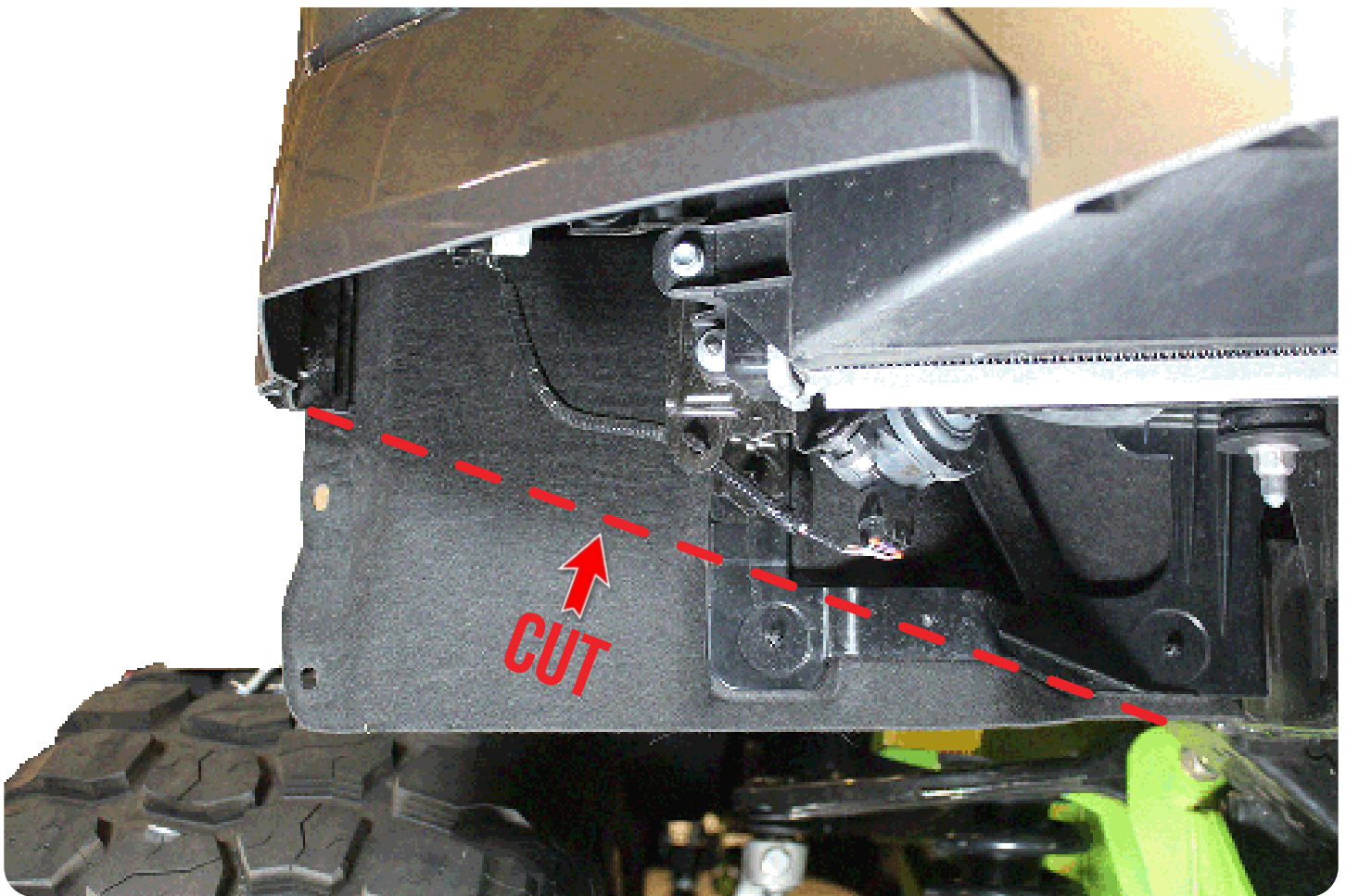



INSTALLATION GUIDE

STEALTH FIGHTER FRONT BUMPER

22+/TOYOTA TUNDRA

STEP 27

Using a (9/16 wrench/socket) Install the bumper using the provided 3/8 bolts, and washers.

INSTALLATION





INSTALLATION GUIDE

STEALTH FIGHTER FRONT BUMPER

22+/TOYOTA TUNDRA

INSTALLATION

STEP 28

Stand back and enjoy your new ADD Stealth Fighter™ Front Bumper.

Check and re-tighten, if needed, all mounting bolts after 100 miles and periodically thereafter.



THIS PRODUCT IS PROTECTED BY ONE OR MORE U.S. PATENTS
WWW.ADDICTIVEDESERTDESIGNS.COM/PATENTS

FOR ADDITIONAL SUPPORT OR TECHNICAL QUESTIONS,
PLEASE CALL 480-671-0820 OR
EMAIL INFO@ADDICTIVEDESERTDESIGNS.COM