

Cat Wall Stepper Instructions

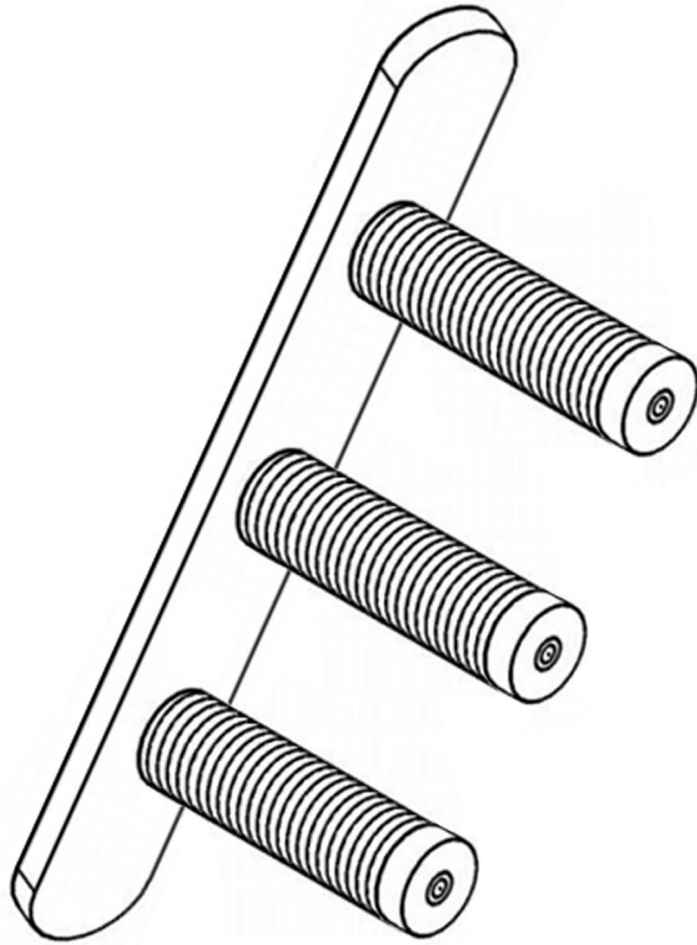

CM14



PET OMG

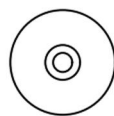
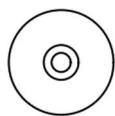
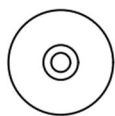

$A \times 3$

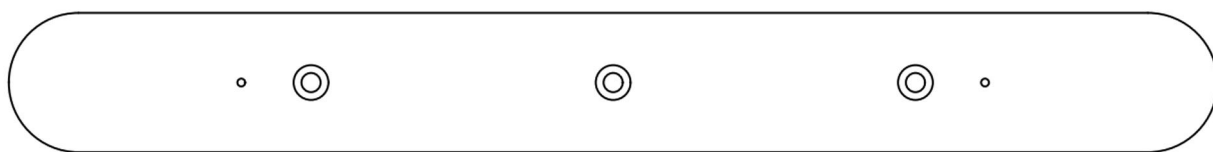

$B \times 1$

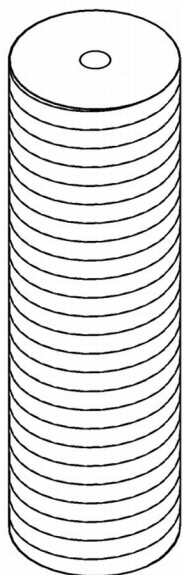

$a \times 3$

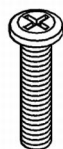

$b \times 6$



$c \times 2$

1

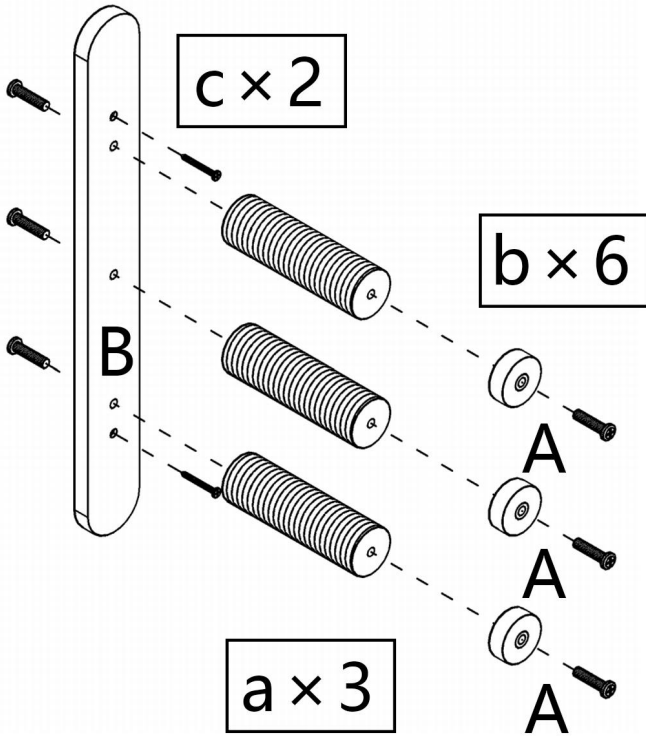

2

