



Ecox 3E PORTABLE POWER STATION

USER MANUAL



■ SAFETY INSTRUCTIONS

IMPORTANT SAFETY INFORMATION

Please read and understand all safety instructions carefully to ensure safe operation and application of the power station. Severe injury or property damage may be caused by failure to follow instructions.

The loss caused by misuse of POWER STATION is not covered by our Warranty

CHARGE NOW

Please FULLY charge the POWER STATION as soon as possible once you receive it.

The battery may be in sleep mode or lose power during long periods of transport and storage.

Plug the POWER STATION into the wall outlet for 10 minutes to reactivate the battery. If the battery still not charged after 10 minutes, please contact customer service team.

Note:

When turning on the AC Button, the LCD Display may show Output Power watts being drawn before you have plugged the load into the AC outlet. This is normal reaction caused by the "no-load" discharge. It is recommended that you turn off the output button(s) when not in use.

■ FEATURE DETAILS

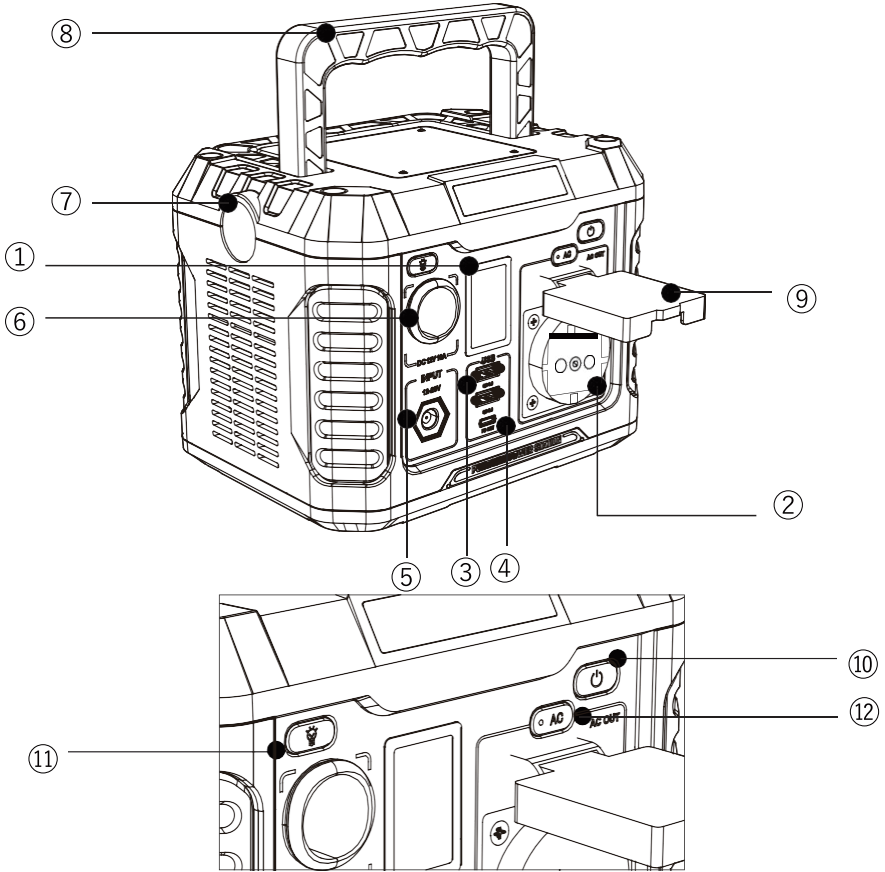

1. LCD Screen Display

2. AC Outlet

3. USB-QC3.0

4. USB-TYPE-C 60W

5. DC Input

6. Cigarette Lighter Output

7. Flashlight

8. Handle

9. Protective Cover

10. Power ON/OFF Button

11. Flashlight ON/OFF Button

12. AC Output ON/OFF Button

■ OPERATION GUIDE

FUNCTION BUTTONS



Power ON/OFF Button



AC ON/OFF Button



Flashlight ON/OFF Button

11: POWER ON/OFF Button

POWER ON/OFF BUTTON is the Master Switch. Press POWER ON/OFF BUTTON to activate the AC BUTTONS.

12: Flashlight ON/OFF Button

Press FLASHLIGHT BUTTON once to turn on the flashlight, press it again to turn off the flashlight.

Press and hold the FLASHLIGHT BUTTON over 3 seconds to switch to the SOS mode.

13: AC ON/OFF Button

Press AC Output ON/OFF BUTTON to activate AC output port.

■ OPERATION GUIDE

LCD FEATURES

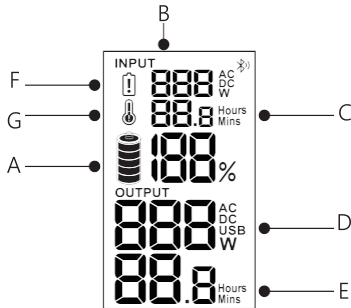

- A: Battery Level
- B: Input Power
- C: Remaining Charging Time
- D: Output Power
- E: Remaining Usage Time
- F: Low Voltage Warning
- G: Temperature Warning

DETAILS DISPLAYED ON LCD

Battery Level: The percentage figures and the number of battery bars represent remaining capacity.

PLEASE BE AWARE that this value varies as the energy consumption of the load changes.

Charging the POWER STATION when the battery level is below 20%. Please note that when you first charge the POWER STATION, either a solar panel or an AC Charger, it may take a few minutes to detect and adjust its charging circuit before it begins to draw power.

Remaining Charging Time: Real-time display of remaining charging time in hours and minutes.

Input Power: Real-time display of Input Power in Watts.

Remaining Usage Time: Real-time display of remaining service time in hours and minutes.

Output Power: Real-time display of the total Output Power in Watts (Cigarette Lighter Port, USB-A, USB-C and AC).

Low Voltage Warning: Please recharge the power station when the low voltage warning sign lights up.

Temperature Warning: The Temperature Warning sign will light up when the battery temperature of POWER STATION is too low/high. All functions will return to normal when the battery temperature revert to the working range.

■ GENERAL SPECIFICATIONS

Model	Ecox 3E
Battery	Lithium Battery
Capacity	231Wh (22.2V,10.4Ah)
Dimensions	L192x W142x H148mm
Weight	2.76 kg
Charging Temperature	32 to 104°F (0 to 40°C)
Discharging Temperature	14 to 104°F (-10 to 40°C)
DC Input	12-28V \approx 48W Max
AC Outlet	1x230V \sim 50Hz 300W,600W surge
Cigarette Lighter Port	1x 12V \approx 10A
USB-A Port	2x 5V \approx 3.4A,9V \approx 2A,12V \approx 1.5A,total 36W Max
USB-C Port	1x 5V \approx 3A,9V \approx 3A,12V \approx 3A,15V \approx 3A,20V \approx 3A, total 60W Max
Flashlight (SOS Mode)	1x 1W

ACCESSORIES

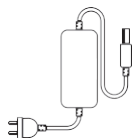

• AC Adapter

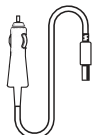

• Car Charger Cable

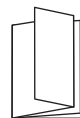

• User Manual









NOTICES:

- Check the input charge cable. The charging process can work efficiently only the input charge cable meets the specification outlined in the GENERAL SPECIFICATIONS section.
- Only charge POWER STATION with provided AC adapter.

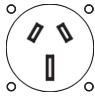
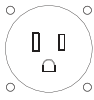
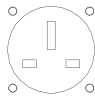
■ GENERAL SPECIFICATIONS

NOTICE:

Available in multiple AC outlet types.

Country			Voltage/Frequency			Country			Voltage/Frequency		
Universal			Israel	220V, 50Hz							
China	220V, 50Hz		Australia	240V, 50Hz							
Japan	100V, 50Hz/60Hz		UK	230V, 50Hz							
Philippines	220V, 60Hz		Germany	230V, 50Hz							
Korea	220V, 50Hz		France	230V, 50Hz							
US	120V, 60Hz		South Africa	220V, 50Hz							

■ OPERATION GUIDE

HOW TO CHARGE

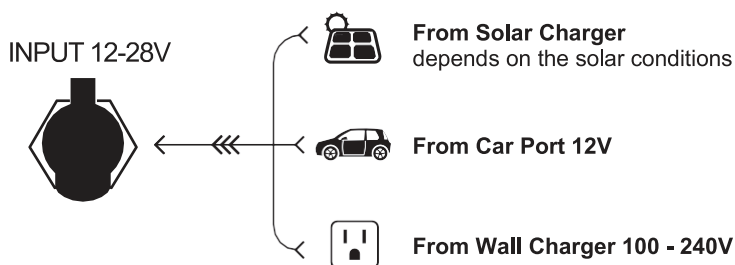

RECOMMEND TO UNPLUG THE POWER STATION WHEN IT'S FULLY CHARGED.

POWERING / CHARGING DEVICES

Select the required outlet by pressing the corresponding switch button.

The Outlet will be activated when the indicator on the button lights up green. The LCD will show the output details. Press the **POWER ON/OFF BUTTON(s)** to turn off the output(s) power when not in use.

PASS-THROUGH CHARGING

The advanced battery management system of the POWER STATION allows powering device via DC & USB & AC output(s) while it's charging.

OVERLOAD CONDITION

If the overload condition occurs to the **OUTPUT**, **POWER STATION** will automatically turn off the battery power..

- The LCD still display values.
- The DC Output will still be the same status as normal.

OPERATING INSTRUCTIONS

CHARGING POWER STATION

The LCD shows the battery level while charging. POWER STATION is fully charged when the figure turns to 100%.It is recommended to **FULLY** charge POWER STATION every 3 months to extend the battery lifespan.

■ OPERATION GUIDE

APPLIANCE WATTS REFERENCE



Laptops
(41.4Wh)



32" TV
(60W)



CPAP without heated
humidifier (15W)



Mini Fridge
(40W)



DJ Drone
(89.2Wh)



Smartphone
(10Wh)



GoPro
(5.9Wh)



Floodlight
(4W)



Switch
(16Wh)



Please power/charge the appliances within the rated power of power station.
The Watts/Watt Hours listed above are just for reference and not suitable for all cases.
Please check your appliance use manual for the actual power.

■ TROUBLESHOOTING

MAINTENANCE

Recharge as you need. There are no pre-designated intervals at which to recharge as long as the POWER STATION is used regularly. Avoid fully depleting the battery to 0%, it will impact the quality and lifespan of the battery. Periodically inspect all ports and wall chargers for any debris, dirt, damage, and corrosion.

DO NOT attempt to fix it on your own.

DO NOT cover the POWER STATION with towels, clothing, or other items. Periodically check the side vents to make sure there is no dirt or dust. If there is debris, follow the cleaning procedures in the manual to clean the device.

CLEANING

Make sure any input power and output devices are **NOT** plugged into the POWER STATION. Wipe it with a clean, dry, soft, lint-free cloth. Remove any debris, dirt, or other blockages from the side vents and prevent them from falling into the interior of the Power Station.

DO NOT use abrasive cleaners or corrosive solvents.

DO NOT use compressed air to clean side vents.

DO NOT use metal objects to clean the ports to avoid the risk of electric shock .

STORAGE

Please fully charge the POWER STATION if the storage time is more than one month.

Recharge the POWER STATION every 3 months to avoid possible damages from a full discharge. Please store in a cool, moderately humid room out of direct sunlight (Refer to GENERAL SPECIFICATIONS section). Leaving POWER STATION in a car or other confined space with extremely hot temperatures will overheat the battery, resulting in a shortened lifespan and even fires.

Extremely cold temperatures will affect the performance and lifespan of the POWER STATION. Keep away from corrosive chemicals and gases. After taking the POWER STATION out of storage, check and make sure all the accessories are in good condition. Review the air intake and side vents to ensure they are clear of debris. Ensure safe environmental conditions are met before the POWER STATION recharge or charging other appliances.

DISPOSAL/RECYCLE

Please fully discharge the battery before disposing it. Due to the presence of hazardous chemicals, please dispose of batteries only in designated recycling channels, not with regular trash. Consult your local laws regarding battery recycling and disposal.

If the battery cannot be fully discharged due to product failure, please contact a professional battery recycling company for further processing.

Please dispose of batteries that no longer recharge.

■ TROUBLESHOOTING

Indicator	Phenomenon	Solutions
E1	AC Output Overload Warning	Please charge/power the devices within the rated power. Otherwise, the POWER STATION will automatically turn off.
E2	AC Output Off	Please charge/power the devices within the rated power. And then push the AC button to restart.
E3	DC Output Overvoltage / Undervoltage	Please charge/power the devices within the rated Voltage of DC and then press the ON/OFF Button to resume the functions.
E7	DC Output Overload Protection	Please charge/power the devices within the rated power of DC and then press the ON/OFF Button to resume the functions.
E8	USB Output Overload Protection	Please charge/power the devices within the rated power of USB and then press the ON/OFF Button to resume the functions.
E4/E5/E6/E9	Output Overload Protection	When E1/E7/E8 occurs, E4/E5/E6/E9 will be displayed to more accurately identify the problem. . Please charge/power the devices within the rated powers and then press the corresponding button to restart.
E62	Over-long Charging Reminder	Stop charging after 100%.
E72	Charging Safety Protection	Unplug the charging cable and turn off the device, plug in again after a while.

NOTICE:

If none of these solutions work, or if you see a warning code different from the one listed above, please stop using the power station, record the warning code, and contact customer service for further instructions.

■ TROUBLESHOOTING

Problem	Solutions	Remark
Unable to Charge	Check if the AC adapter plug is fully plugged into the DC Input and Wall Outlet.	Confirm whether it is a connecting issue.
	If the connection is good, check that the AC adapter light is on.	If the light is still off, please contact customer service for help.
	The charging indicator is on, but it still can't charge.	Contact customer service for help.
No Output	Ensure that the DC/USB/AC outlets are activated by pressing the corresponding button.	Once the corresponding button (s) is turned on, the output Watts will show on the LCD screen.
	Check the connected cables are appropriately plugged into the devices and power station.	Confirm the connection condition.
	Check the battery level.	Low battery will affect the outputs.
	Check the watt data displayed on the LCD screen for an overload condition.	Overload will shut down the outputs (For more information, please see the error codes section).
Sudden interruption while using output	The power used by the connected device (s) exceeds the rated power of the POWER STATION. Check if the connected device (s) is suitable for the power station by reviewing the output specifications in the GENERAL SPECIFICATIONS section.	Only plug in devices within the rated Watts. If you need a POWER STATION with a larger capacity(wh), you can browse our website or contact customer service to see which one is suitable for you.
	Check if the output power is too low. If it is too low for a few hours, the power station will automatically shut down. Please press the ON/OFF button to restart the product.	Automatic shutdown for saving power. If you do not want the Energy-saving function, press the ECO button to turn it off.
	Check if it shuts down automatically in case of self-protection-overcurrent, over/under temperature, overload, etc. If so, simply press the power on/off button and restart the power station to restore normalcy.	Several protections to ensure the safe use of power station.

If you encounter any other problems not listed above, please contact customer service for help.

■ WARNINGS

The warnings in this manual cannot cover all possible conditions or situations that may occur.

Please use the POWER STATION with common sense and caution. Always be aware of the environment around you while using the device and ensure safe and responsible use of POWER STATION.

- **DO NOT** use the POWER STATION over its output rated power. Although we have built-in overload protection, overloading may result in the risk of fire or personal injury.
- **DO NOT** use the POWER STATION or AC adapter if it is damaged or modified. Damaged or modified batteries may behave unpredictably, resulting in the risk of fire, explosion or injury.
- **DO NOT** subject to vibration, impacts, or drops. Secure the POWER STATION during transportation. While the housing may not show signs of damage, the internal components may have been damaged. It is recommended to replace it if any such severe event occurs.
- **DO NOT** expose the POWER STATION to moisture, rain, or snow.
- **DO NOT** charge, use or store the POWER STATION in the bathroom or the area exposed to water, rain, or moisture.
- **DO NOT** leave children, people with physical/mental handicap(s), or people who lack of experience and knowledge, along with the POWER STATION unless under the supervision or guidance of their guardians.
- **DO NOT** attempt to repair the POWER STATION or AC adapter. There is no user-repairable component inside.
- **DO NOT** operate the POWER STATION with wet hands.
- **DO NOT** place the POWER STATION on its side or place upside down during use or storage. If rust, odor, overheating, or other abnormal circumstances are observed, stop using it and contact customer service.
- Children should be supervised to ensure that they DO NOT play with the POWER STATION alone.
- POWER STATION is only used as emergency backup power. It cannot always replace the standard AC or DC power supply for household appliances. Keep away from high voltage electric fields.
- Do not open, crush, incinerate or heat it above 104°F (40°C). There is a risk of fire and burns. The use of a power supply, charger, or cable not recommended or sold by portable battery manufacturers may risk fire or personal injury.
- If the liquid inside the POWER STATION come in contact with your skin or clothing, wash the affected areas with water.
- The accessories included in the box should only be used with the POWER STATION.
- KEEP POWER STATION AWAY FROM PETS.

■ CAUTIONS

Transportation: POWER STATION meets all legal requirements for the transport of dangerous goods. Lithium battery pack with a capacity of more than 100Wh must be shipped in IATA standard packaging if POWER STATION is transported by air, according to international standards. IATA instructions and labeling requirements and related declarations must be completed.



Not allowed to carry on the aircraft.



Avoid dropping.



To maintain the battery lifespans, please use and fully recharge at least once every three months.



Do not disassemble.



Use original or certified charger and cables.



Non-waterproof, DO NOT expose to liquids.



Avoid extreme temperature.



Please dispose of batteries and electronic items according to local regulations.

WARRANTY

PYTES B.V. provides a limited warranty for the original consumer's purchase, which covers the products due to defective workmanship and materials for 12 months from the date of purchase. In order to clarify the start date of the warranty period, the sales receipt from the consumer's first purchase, or other reasonable documentary evidences are required. Our warranty does not apply to (i) Any product that has been misused, abused, modified, accidentally damaged, or used for any purpose not authorized in the company's current product datasheet, or (ii) Any product purchased through an online auction house. Please contact our customer service team for more information and to obtain warranty service.

STATEMENT

All rights reserved. All trademarks cited herein are the property of their respective owners. The information contained herein is subject to change without notice. The only warranties for the products and services are outlined in the warranty statements accompanying.

We shall not be liable for technical or editorial errors or omissions contained herein.

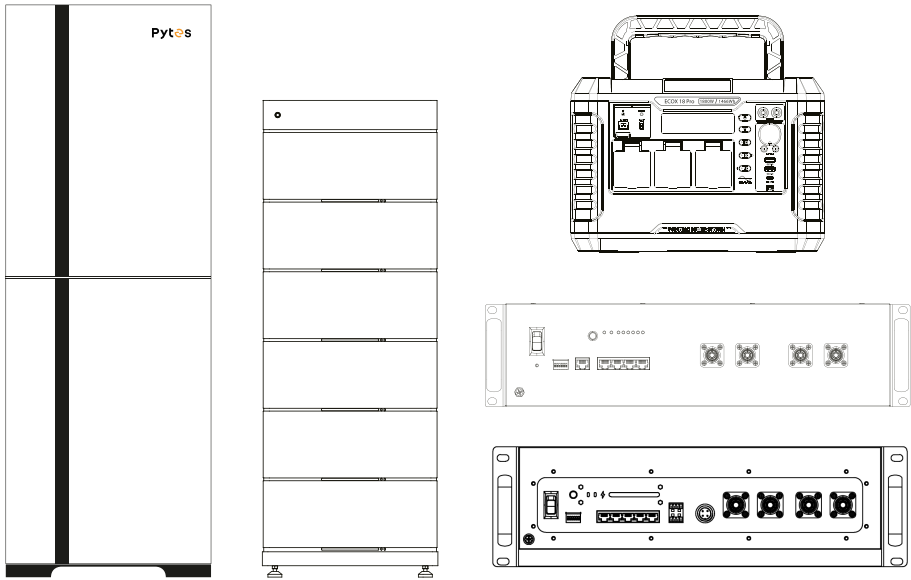

 Netherlands: Molendijk-Zuid 23B,5482 WZ Schijndel

 pytesess@pytesgroup.com

 www.pytesess.com

 (+31)0625560152

Scan to follow us

