

1. Introduction

The 18Gbps 8x8 seamless UHD Matrix can connect 8 HDMI sources to 8 HDMI displays. Supported video resolution is up to 4K60 4:4:4. The product supports IR matrix, and IR matrix routing follows the video routing. Audio extract and insert are supported. The product supports one or more video wall with RS232 command.

2. Features

- ☆ HDMI 2.0 and HDCP 2.2 compliant
- ☆ Support 18 Gbps video bandwidth
- ☆ Support seamless switching
- ☆ Support video wall
- ☆ Support IR matrix
- ☆ Support HDMI audio extract
- ☆ Support external L/R audio insert on HDMI stream
- ☆ Support EDID management
- ☆ HDMI video output resolution up to 3840x2160@60
- ☆ Support front panel, RS232, TCP/IP (LAN 10M/100M) control

3. Package Contents

- ① 1 x 8x8 seamless UHD Matrix
- ② 1 x AC Power Cord
- ③ 1 x Matrix IR Remote
- ④ 4 x IR Receiver cable (1.5 meters)
- ⑤ 4 x IR Blaster cable (1.5 meters)
- ⑥ 1 x CAT6 cable
- ⑦ 1 x USB to RS232 Cable
- ⑧ 1 x User Manual

4. Specifications

Technical	
HDMI Compliance	HDMI2.0
HDCP Compliance	HDCP2.2
Bandwidth	18Gbps
Video Resolution	
Input	800x600@60Hz, 1024x768@60Hz, 1280x768@60Hz, 1280x800@60Hz, 1280x1024@60Hz, 1360x768@60Hz, 1366x768@60Hz, 1400x1050@60Hz, 1440x900@60Hz, 1600x1200@60Hz, 1680x1050@60Hz, 1920x1200@60Hz, 480p, 576p, 720p, 1920x1080i, 1920x1080p, 3840x2160@24Hz/25Hz/30Hz/50Hz/60Hz, 4096x2160@24Hz/25Hz/30Hz/50Hz/60Hz.
Output	1920x1080@60Hz, 3840x2160@30Hz, 3840x2160@60Hz, 1280x720@60Hz, 1024x768@60Hz, 1360x768@60Hz, 1600x1200@60Hz, 1920x1200@60Hz
HDMI Amplitude	T.M.D.S +/- 0.4Vpp
Differential impedance	100±15ohm
ESD Protection	Human-body Model: ±8kV (Air-gap discharge) , ±4kV (Contact discharge)
RS232/Ethernet Control	
Baud rate and protocol	Baud rate: 9600, data bit: 8, stop bit: 1, no parity checking
Ethernet	IE10.0+, HTML5
Mechanical	
Housing	Metal Enclosure
Color	Black
Dimensions	430mm (L) X 300mm (W) X 44mm (H)
Weight	5kg
Power Supply	AC 110 - 240V
Power Consumption	100W (Max)
Operating Temperature	0°C ~ 40°C / 32°F ~ 104°F
Storage Temperature	-20°C ~ 70°C / -4°F ~ 158°F
Relative Humidity	10%~50% RH (non-condensing)

5. Operation Controls and Functions

Front Panel

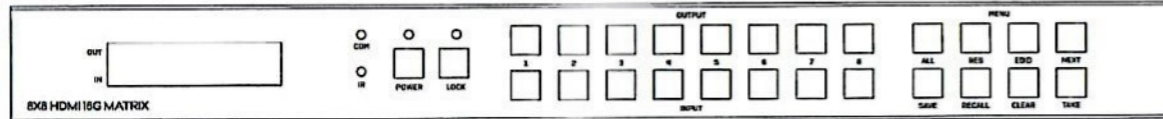

Item	Description
LCD Panel	Displays the current video selections
COM	Control comands indicator
IR	IR signal indicator
POWER	Power LED
LOCK	Front panel lock/unlock
OUTPUT	Output selection buttons 1~8
INPUT	Input selection buttons 1~8
ALL	Set all outputs to the next input selection
RES	Set the output scaler resolution
EDID	Set the EDID options for the next input selection
NEXT	Select the next available option
SAVE	Save the current matrix setting as a preset
RECALL	Set the matrix setting from a saved preset
CLEAR	Cancel the current command function
ENTER	Set the displayed option

- Press buttons OUTPUT n + INPUT m+ TAKE by sequence to switch matrix routing.
- Press button POWER to make the matrix enter or release standby state. When standby, the power LED will be lighted.
- Press button LOCK to lock or un-lock front buttons. When locked, the Lock LED will be lit.
- Press buttons ALL + INPUT m + TAKE by sequence to switch input m to all the outputs.
- Press button SAVE + OUTPUT n to save current routing scene as scene n. Up to 8 scenes can be saved.
- Press button RECALL + OUTPUT n to recall routing scene n as current routing.
- Press buttons RES + OUTPUT n + NEXT + TAKE to change output resolution of OUTPUT n port.

Resolution Option

Number	Output Resolution Setting	Number	Output Resolution Setting
1	3840x2160@60Hz	9	1400x1050@60Hz
2	3840x2160@50Hz	10	1366x768@60Hz
3	3840x2160@30Hz	11	1360x768@60Hz
4	3840x2160@25Hz	12	1280x1024@60Hz
5	1920x1200@60Hz	13	1280x768@60Hz
6	1920x1080@60Hz	14	1280x720@60Hz
7	1920x1080@50Hz	15	1280x720@50Hz
8	1600x1200@60Hz	16	1024x768@60Hz

- Press buttons EDID + INPUT m + NEXT + TAKE to change the EDID mode of port INPUT m.

EDID options:

Number	Output Resolution Setting	Number	Output Resolution Setting
1	Manual	5	1920x1080@60Hz
2	3840x2160@60Hz	6	1280x1024@60Hz
3	3840x2160@30Hz	7	1280x720@60Hz
4	1920x1200@60Hz	8	1024x768@60Hz

Rear Panel

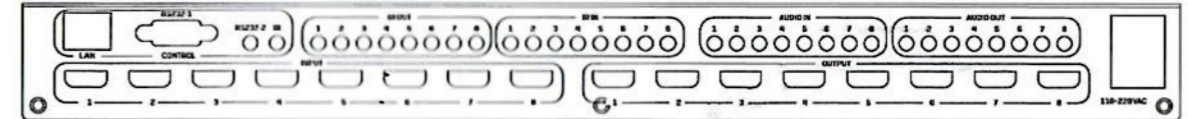

- LAN(10M/100M), RS232 are for PC control.
- Analog Audio IN/OUT ports bind to corresponding HDMI ports.
For example:
if INPUT HDMI 1 signal is DVI, matrix will use analog AUDIO IN 1 as HDMI 1 audio source (Note: Analog AUDIO IN is only available when the corresponding video input is DVI signal).
Analog AUDIO OUT n will always output the same audio content with HDMI OUTPUT n.
- IR IN and IR OUT
IR IN/OUT is for remote control routing, and follows the video routing.
For example:
if input HDMI m is routeed to output HDMI n1 and n2 ports, then IR IN n1 and n2 ports will be routed to IR OUT m port.
Here with is the illustration of the relationship between video and IR routing.

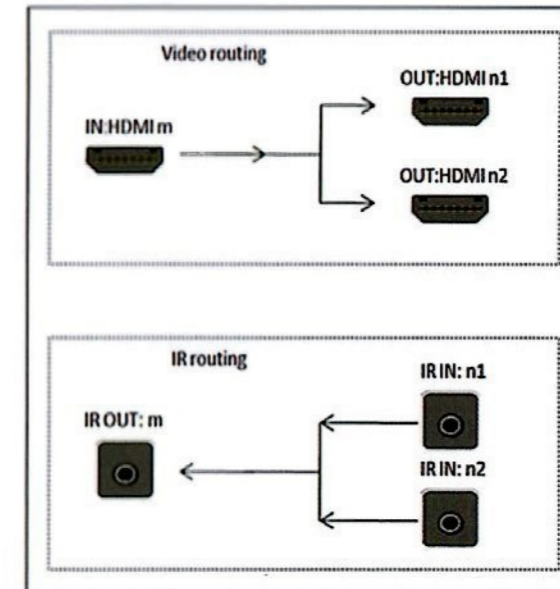

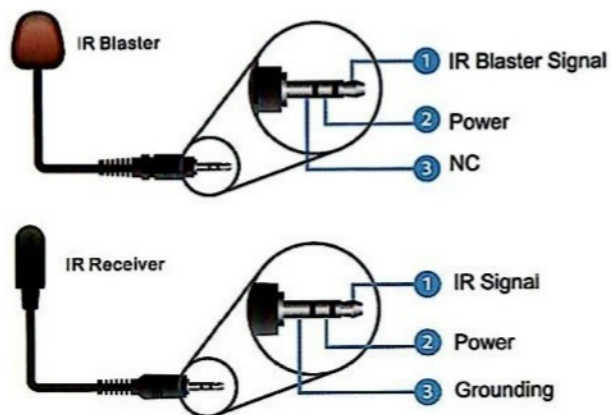

IR extender connectors (not as accessories)

6. RS232/LAN Control Connection

6.1 RS232 Control Connection

The product supports RS232 control. Connect the RS232 port of the product to a PC via a RS-232 to USB cable, as shown in the following figure:



6.2 Network Control Connection

The product also supports Network control. Connect the LAN port of the product to a PC via an UTP cable, as shown in the following figure:

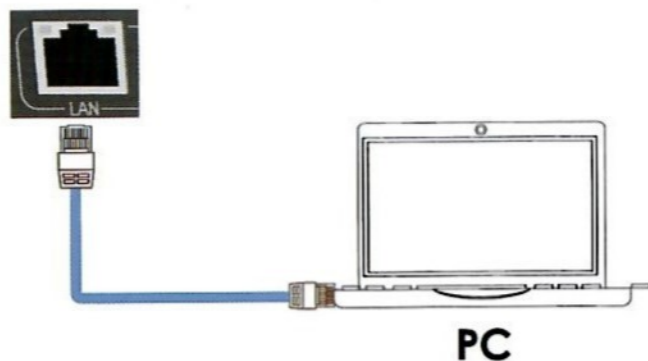

Note: Factory default network setting:

IP Type	Static IP
Static IP	192.168.0.247
Subnet Mask	255.255.255.0
Gateway	192.168.0.1

7. PC Tool User Guide

7.1 Account's Authentication

Before running the PC tool, the password is needed for authentication.

Default password of Administrator (access to all features: 111111)

Default password of User (access to all features, except OSD function) : 000000

7.2 Connect with PC Tool

1. The default PC tool's UI style is as below.

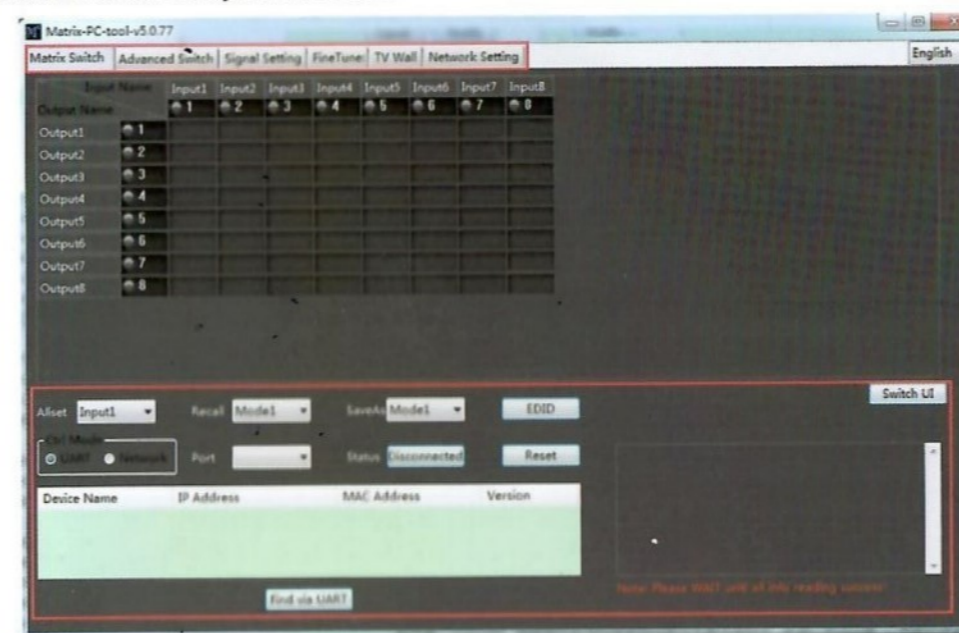

2. You can select **UART** (with RS-232 cable) or **Network** to connect, baud rate is 9600 bps.

3. Default IP address: 192.168.0.247.

7.3 Matrix Switch Page

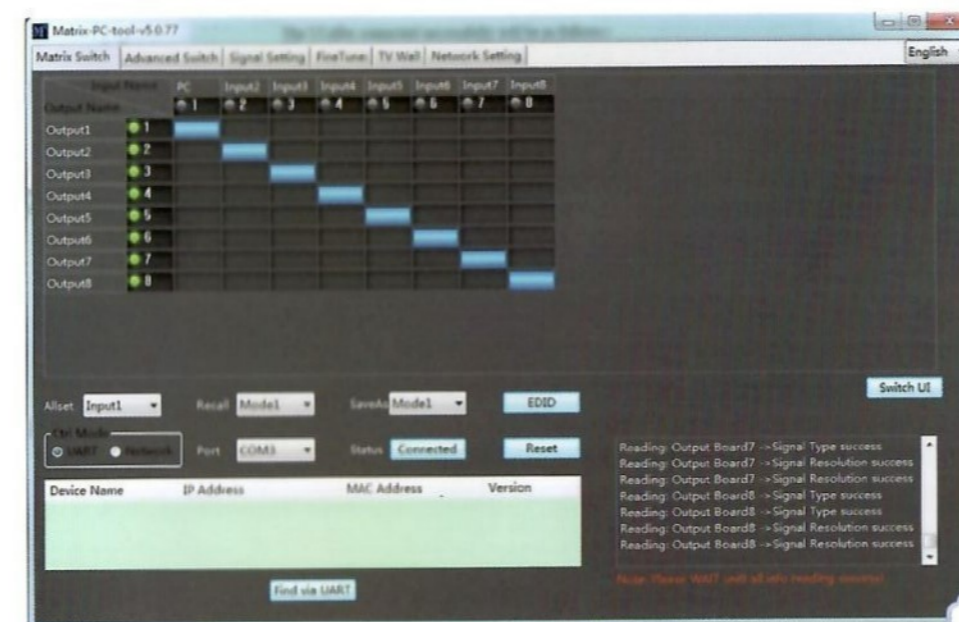

1. There are 3 options for Matrix Switch page, user can press "Switch UI" button to change the UI style. Suggest to use the default one.
2. There is a shortcut button to switch one input port to all output ports, that is Allset, For example, switch input 1 to all outputs, user can select

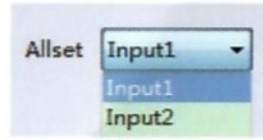

3. Recall mode: Recall a input/output routing scene which already be saved before. The device supports maximum 8 scenes.
4. Save mode: Save the current input/output routing in one index. Maximum 8 modes supported.

Note: Save/Recall button here works the same with front panel save/recall control and also the same with Save/Load function on video wall page.
5. System reset: The PC tool supports reset system to recover to factory configuration.
6. EDID Control: Click the "EDID" button on Matrix Switch page, there will be a pop-up EDID control window. User can do following operations:

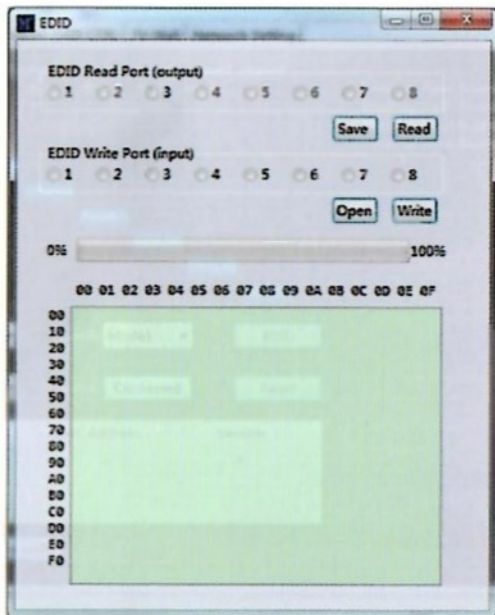

- a) Read EDID: Select the output port, then click the "Read" button to read EDID.
- b) Write EDID: First read a EDID from output port, or open a EDID file that saved before, then select the input port, and click the "Write" button to write EDID.
- c) Save EDID: After reading EDID successfully, click "Save" button, and select the save path and file name for saving.
- d) EDID Manual: The written EDID above will be as the manual EDID data. When user select EDID mode with Manual mode by front panel for one input port, matrix system will use this data as the EDID data for the port.

7.4 Signal Setting Page

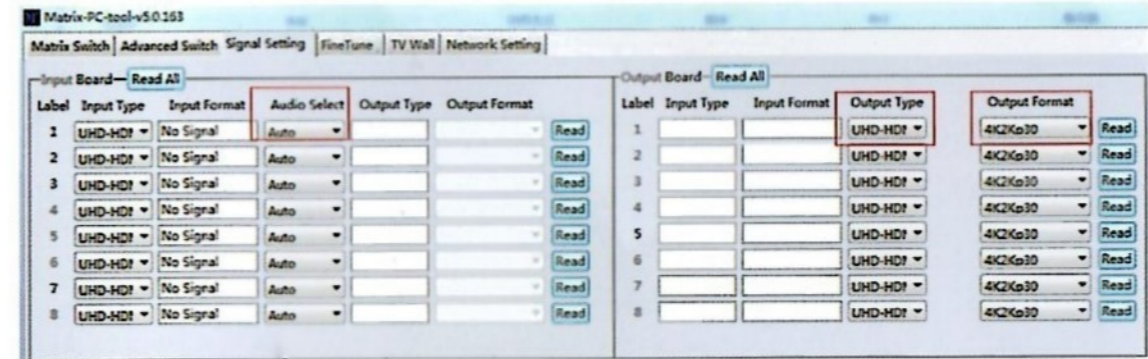

1. Audio Select

There are two options for input Audio Select.

 - a) Auto: If the input source is HDMI signal, system will get the embedded audio; if the input source is DVI signal, the system will get the corresponding analog audio.
 - b) External: System will get the corresponding analog audio.
2. Output Type

There are four options for input Output Type: UHD-HDMI (HDCP OFF), UHD-DVI, UHD-HDCP-1.4, UHD-HDCP-2.2.
3. Output Format

User can set the output resolution: 3840x2160@60, 3840x2160@50, 3840x2160@30, 3840x2160@25, 1920x1200@60, 1920x1080@60, 1920x1080@50, 1600x1200@60, 1400x1050@60, 1366x768@60, 1360x768@60, 1280x1024@60, 1280x768@60, 1280x720@60, 1280x720@50, 1024x768@60.

7.5 FineTune Page

You can read and set the Brightness/Contrast/Saturation/Sharpness of each output.

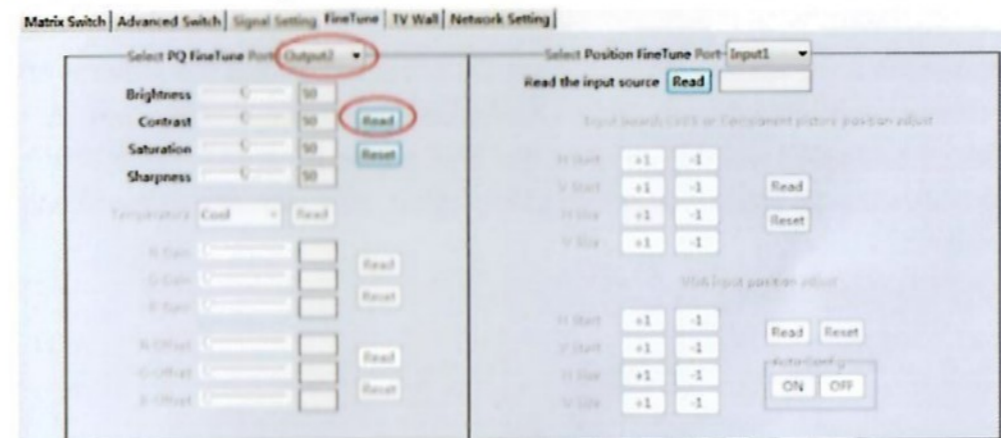

Note: Do not change the default settings without special conditions; If there is a problem after changing, click "Reset" to return to the factory settings.

7.6 Video Wall Page

This page is used to configure a group of outputs to function as a video wall.

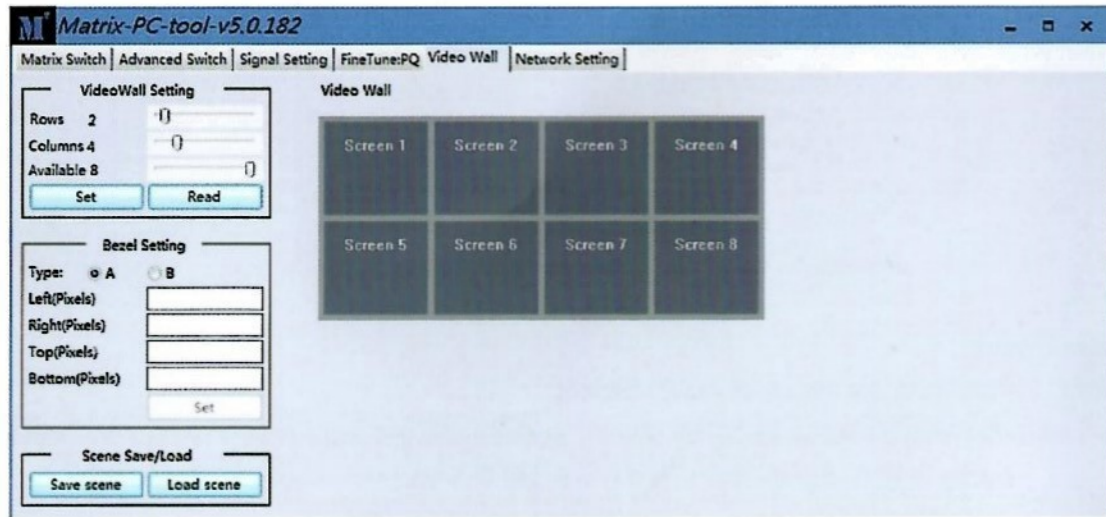

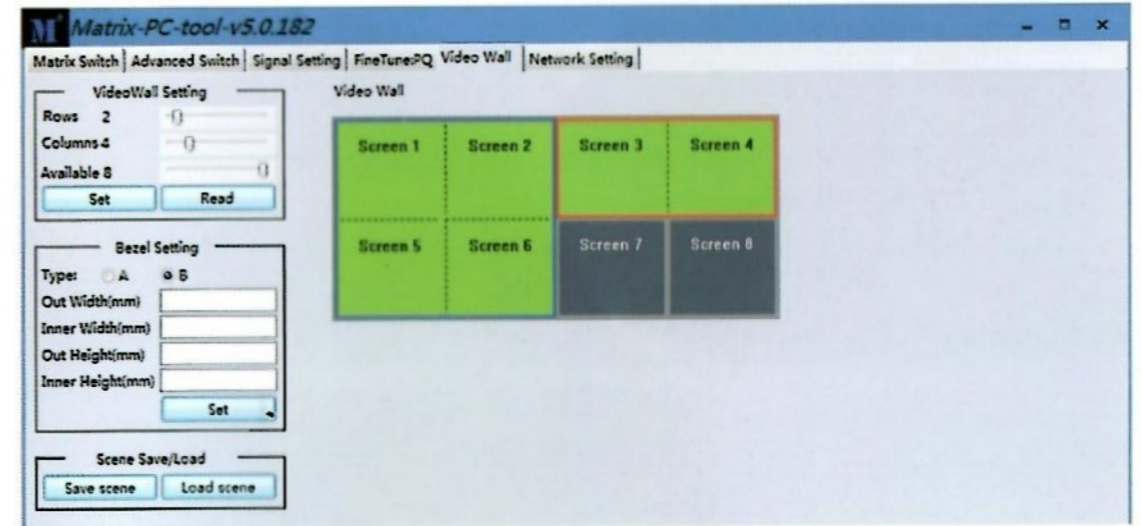

1. Use the Video Wall Setting controls to change how the displays are arranged on the Video Wall page:
 - a. Adjust the Rows and Columns sliders to change the displayed screen arrangement to permit proper Drag-and-Select of the desired screens for the video wall.
 - b. Change the Available slider to set how many outputs will be used for the Video Wall.
 - c. Click the "Set" button to change the Screen configuration.
2. Use the left mouse button to drag-select the screens that will be set for video wall mode. The selected screens will be shown as bright blue.
3. Use the right mouse button to open a menu.
4. Select "Screen Splicing" from the menu to program the video wall mode. The selected screens will now be shown as bright green.
5. To change the displayed image: right-click to open the pop-up menu and select the desired input from the "Input Select" menu option.
6. Repeating steps 2 ~ 5 above with a different set of outputs allows the creation of a second video wall. However, changing the Rows, Columns and Available sliders will automatically delete the current video wall set up when the "Set" button is clicked. The following example shows a more unusual video wall set-up of two video walls with one 2x2 wall and one 2x1 configurations:

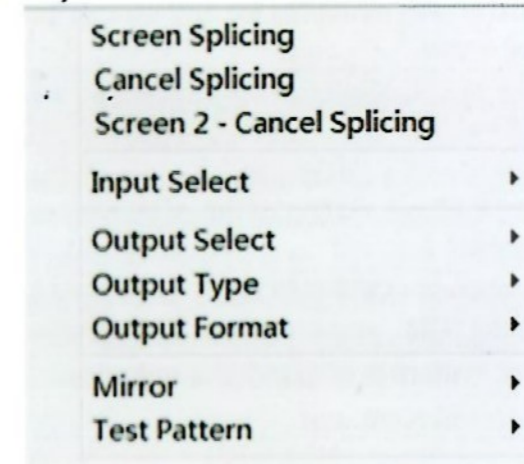

7.6.1 Video Wall Context Menu

Right clicking on any of the screen icons will display the following context menu:



Screen Stitching	This option connects the selected screens into a video wall configuration.
Cancel Stitching	Return the Video Wall configuration to normal outputs.
Screen x – Cancel Stitching	Remove the single screen x from the video wall to allow the displaying another full frame image within the video wall configuration, as shown in this example:  Video Wall display with bezel compensation and different full frame image on display 3
Input Select	Use the sub-menu to select the input to display on the video wall or the secondary input image shown in the above example.
Output Select	This option is only available for any screen that is not assigned to a video wall mode.
Output Type	This option is only available for any screen that is not assigned to a video wall mode.
Output Format	This option is only available for any screen that is not assigned to a video wall mode. It allows setting of the output resolution for the selected screen output.
Mirror	Two sub options : OFF (default), ON (H+V Mirror) When select "ON", you can make 180° rotation with the selected screen.
Test Pattern	When Test Pattern is enabled, the output will display Color Bar pattern.

Bezel Setting

The Bezel Setting section allows the entry of values to compensate for the display bezel thickness. These values may be entered either as pixels (Type A) or as milli metre (Type B).

Type A Bezel Settings

The image size will be adjusted to allow for the number of pixels entered in each of the entry boxes. Click the "Set" button to view the effect of the new values.

Type B Bezel Settings

The image size will be adjusted to allow for the Inner and Outer display dimensions as entered in each of the entry boxes. Click the "Set" button to view the effect of the new values.

Bezel Compensation

The following images demonstrate the effect of not having bezel compensation and what a correctly configured bezel compensation settings should produce:

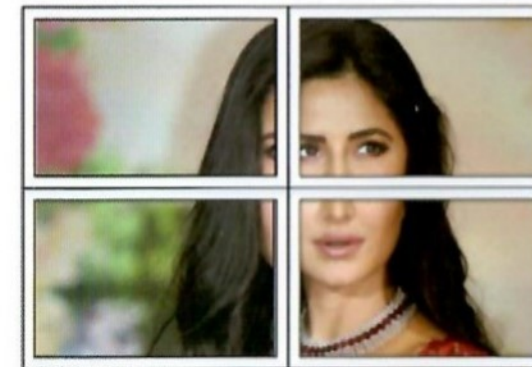

No Bezel Compensation



Correct Bezel Compensation

7.6.2 Layout Save/Load

The Save Scene/Layout and Load Scene/Layout buttons allow a video wall configuration to be saved or recalled at any time. Up to 10 configurations, each with their own name can be saved or recalled. When saving, each Scene can optionally be given a name to identify that video wall scene setup.

8. Control via Web

- If you do not know the matrix IP address: click on the Network Settings page, and then click "Search Device", and then select the device that found, click "Open Website" to open the web control web site, or can input the IP on the web browser, then enter the username (admin) and password (admin) so that you can control the matrix switch function and use the website.

NOTE: The computer IP and matrix IP must be in the same segment and the same local area network; For example, the matrix's IP is 192.168.1.xxx, then the computer IP must be 192.168.1.yyy; Otherwise you need to change the matrix's IP or the computer's IP. The browser must support HTML5 feature, which must be IE10 and above.

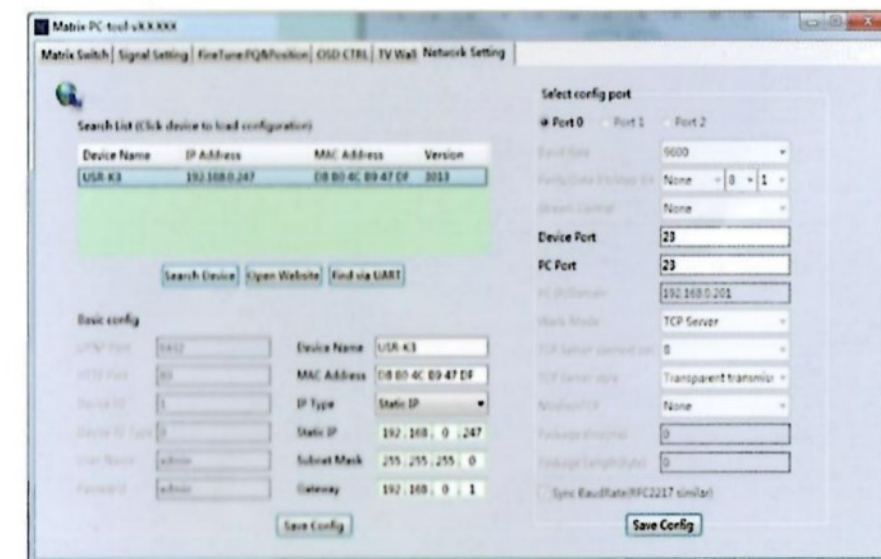

- If the matrix IP address is known: Input the IP on the web browser, then enter the username (admin) and password (admin) so that you can control the matrix switch function and use the website. Note: the browser must support HTML5 feature, which must be IE10 and above.