

High-precision Roundness / Cylindricity Measuring System ROUNDTEST RA-H5200 SERIES

Form Measurement



World-class Accuracy with Simple Operation

ROUNDTEST RA-H5200

World-Class Accuracy

High-accuracy, automatic centering/leveling turntable

A highly accurate, highly rigid turntable has been achieved through exceptional manufacturing accuracy of the critical components, in addition to a high-accuracy air-bearing that provides superior rigidity. The resulting rotational accuracy, the heart of the roundness/cylindricity measuring system, is world-class at $(0.02+3.5 H/10000) \mu\text{m}$.

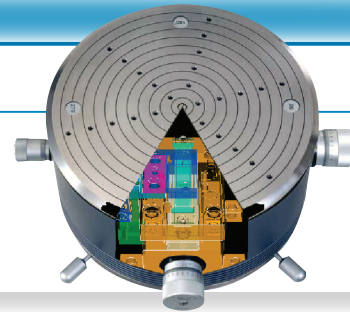

High-rigidity base

For a measurement system to be able to achieve high accuracy, the base, which forms the foundation of the system, must be completely rigid. Therefore, we utilized FEM structural analysis simulation to thoroughly analyze the base and its application. The result is the development of a high-rigidity base.

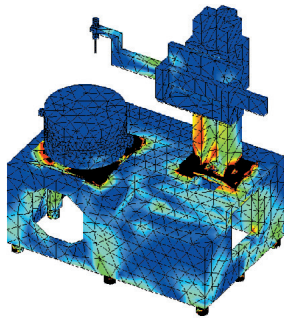

High-accuracy Z-axis column

Attaining the ultimate level of improvement in the manufacturing accuracy of the column guide surface, which is critical for achieving perfect straightness, and adopting Mitutoyo's proprietary system and mechanisms have led to the achievement of the ultra-high column straightness of $0.05 \mu\text{m}/100 \text{mm}$ (in narrow range).

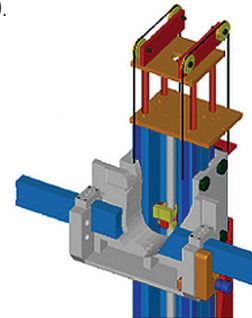

High-accuracy positioning sensors

Mitutoyo's linear encoders have been incorporated into the positioning sensors in the X- and Z-axis drive units to directly sense the displacement the drive units, thereby achieving the highly accurate positioning essential for repeat measurements.

High-performance vibration isolator as a standard feature

The measurement accuracy of a roundness/cylindricity measuring system is greatly affected by external disturbances such as vibration. Therefore, the **RA-H5200** is supplied as standard with a high-performance vibration isolator that possesses excellent vibration attenuation.

Simple and fast high-speed automatic centering and leveling

The centering/leveling mechanism section is equipped with high-precision glass encoders in each axis of the turntable unit to reduce positioning errors and achieve high-speed automatic centering/leveling, greatly reducing the time from workpiece setting to measurement.

The Automatic Adjustment Table (A.A.T.) with centering/leveling adjustment is supplied as standard, which frees the operator from the task of centering and leveling the workpiece.

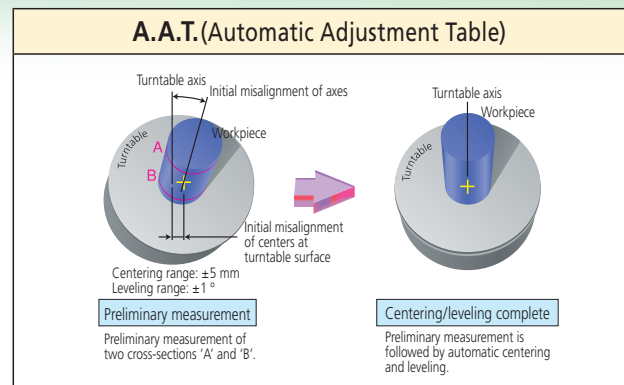

Continuous OD/ID measurement function

Continuous internal/external diameter measurement is possible without changing the detector position.

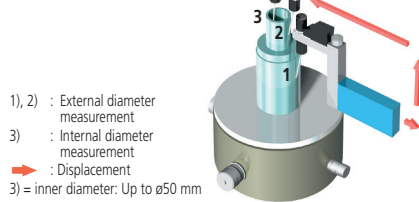

High accuracy even at high positioning speeds

Continual development has resulted in the highest drive speed within the class.

- Vertical direction (Z-axis column): Max. 60 mm/s
- Radial direction: Max. 50 mm/s

Partial circle measurement function

Even if a workpiece cannot be measured by physically rotating it by a full turn due to some obstruction (projection), segments of the circumference can be measured.

Spiral Measurement/Analysis

The spiral-mode measurement function combines table rotation and rectilinear action allowing cylindricity, coaxiality, and other data to be loaded as a continuous data set.

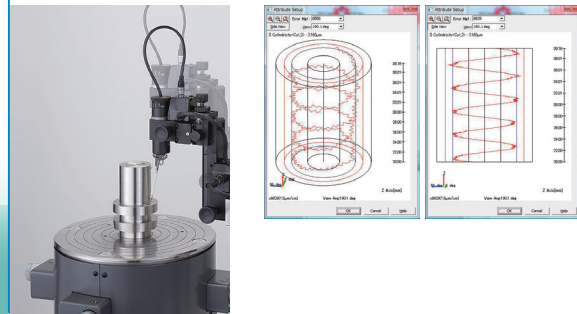

Measurement through X-axis tracking

Measurement while tracing is possible through a built-in linear scale in the X-axis. This type of measurement is useful when displacement due to form variation exceeds the measuring range of the sensor, and X-axis motion is necessary to maintain contact with the workpiece surface.

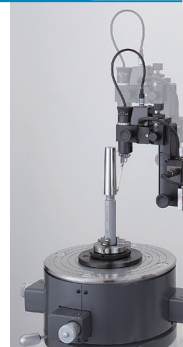

Surface-roughness measuring function (optional roughness unit)

The system is a multi-sensor type, compatible both with a standard probe that meets the specifications of the roundness measuring system and a surface roughness detector unit.

Incorporating the optional roughness detector unit into the system enables roughness measurement in the circumferential direction around the θ -axis, as well as in the direct-drive directions along the X- and Z-axes with the table stopped. Thus, surface roughness and geometric tolerances, such as roundness and cylindricity, can both be validated using only a single system.

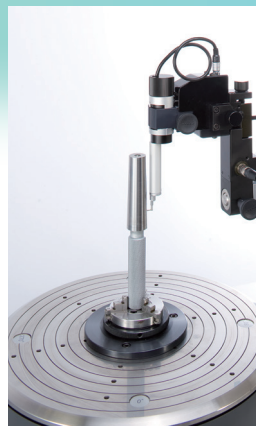

RA-H520



RA-H520 PLUS

World-class Accuracy with Simple Operation

ROUNDTEST RA-H5200

RA-H5200

A roundness/cylindricity measuring system developed to combine world-class accuracy with high maneuverability/analytical capability. This system can perform many other functions as well, such as tracking measurement and automatic OD/ID measurement. Available with the standard column specification (Z-axis traverse of 350 mm) or an extended specification (Z-axis traverse of 550 mm) for handling taller workpieces.



Sliding detector-unit holder provided as a standard feature

The detector-unit holder is equipped with a sliding mechanism, enabling one-touch measurement of a workpiece with a deep hole having a thick wall, which has been difficult with the conventional standard arm.

Sliding distance: 112 mm

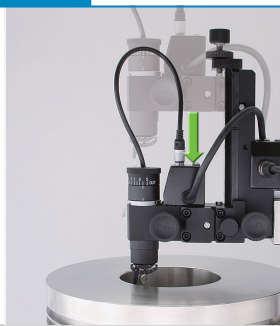

Safety mechanism provided as a standard feature

Patent pending in Japan

A safety mechanism is incorporated into the detector unit area. A collision-sensing function has been added to the detector unit (when it is in the vertical orientation) to prevent collision in the Z-axis direction. Additionally, an accidental collision prevention function, which stops the system when the detector unit displacement exceeds its range, has been added. When an accidental touch is detected, the dedicated analysis software (**ROUNDPAK**) senses the error and automatically stops the system.

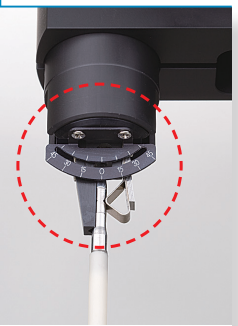

Retrofit kits can be used with models equipped with motorized detector-unit holders

Retrofit kits are available for the RA-H5200AS and RA-H5200AH to add the automatic measurement functionality found in their PLUS counterparts.

*See page 5 for details.

RA-H5200 PLUS

This system combines high accuracy with automatic measurements to greatly improve productivity and efficiency. Automatic orientation control for the detector unit enables this system to automatically execute high-speed, operator-less measurements. Available with the standard column specification (Z-axis traverse of 350 mm) or an extended taller column specification (Z-axis traverse of 550 mm) for handling taller measurement workpieces.



Changes the detector-unit holder orientation for automatic measurement

This function controls the orientation of the holder arm of the detector unit (between vertical and horizontal) and the detector unit rotation mechanism (in 1-degree increments to match the tilt angle of the measurement workpiece), making it possible to measure internal and external diameters as well as top and bottom surfaces continuously and automatically. Additionally, a fully-featured offline teaching function simplifies the creation of part programs.



Detector unit II (option)

This highly adjustable detector unit can be installed on motorized detector-unit holders. Features of this detector unit include the ability to use alternative styli for the **RA-H5200*** and freely change the angle of the stylus.
*See page 8 for alternative styli.



Roundness/Cylindricity measurement/Analysis software **ROUNDPAK**

ROUNDPAK provides simple manipulation using a mouse and icons

Simple operations even with a full set of parameters and analysis functions

A wide variety of parameters, including those for roundness and cylindricity, as well as flatness and parallelism, are provided as standard features. You can visually select these parameters using icons.

ROUNDPAK also comes with specialized analysis functions for design value best-fit, harmonics, and detection of peak or trough points on a circumference. Data that has already been collected can be easily used for re-calculation or deleted.

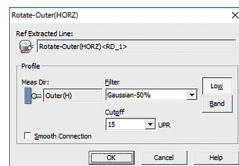
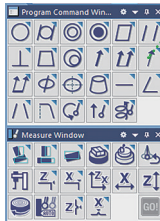

Recalculation

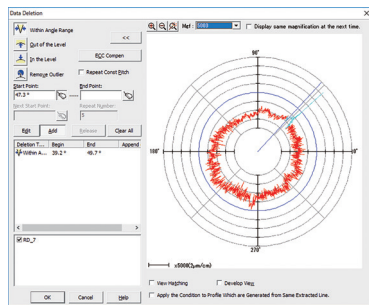

Data deletion

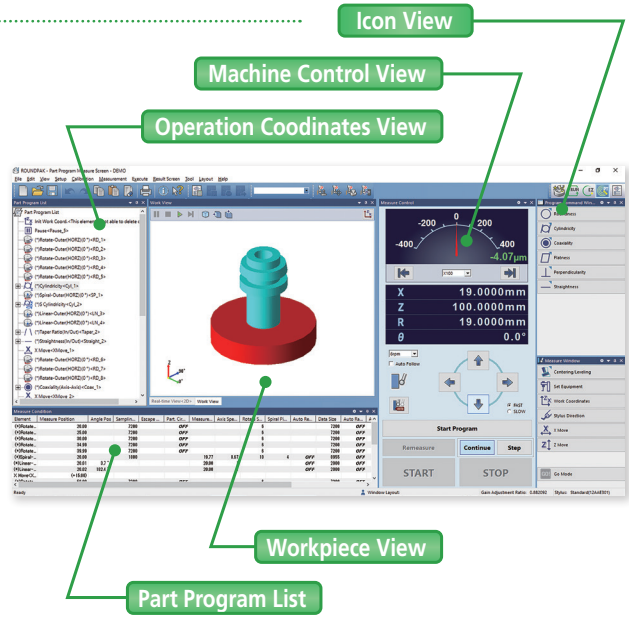

Freedom in laying out the graphics and data obtained from measurements

The customer can create reports in custom formats by specifying how the analysis results will be displayed, as well as the sizes and positions of graphics. The analysis result window can be directly utilized as a layout window. Since the measurement procedure, including the layout information, is saved, the entire process, from measurement start, calculation, result saving, and finally to printing, can be automatically executed.

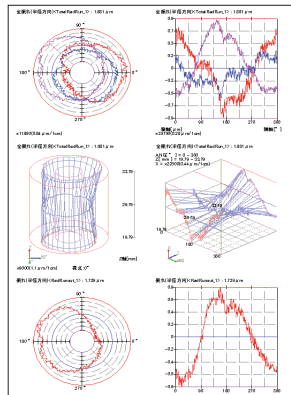
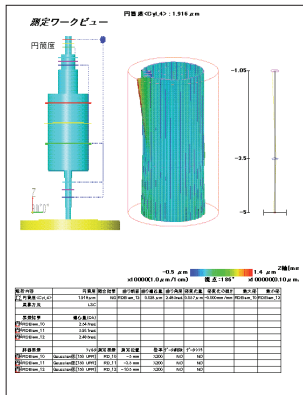
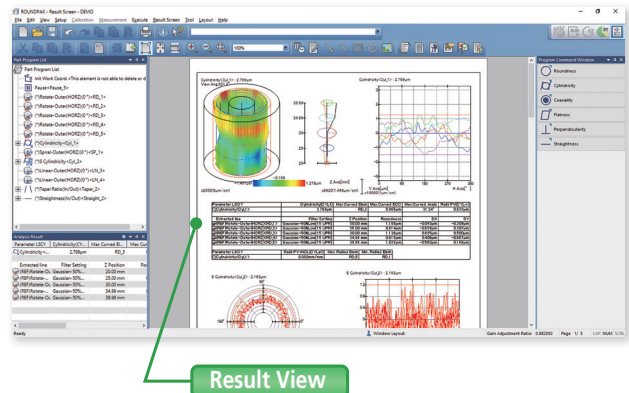

A wide variety of graphics functions

Analysis results such as cylindricity and coaxiality can be visually expressed in 3D graphics.

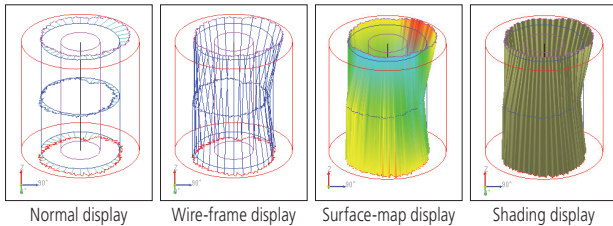

Normal display

Wire-frame display

Surface-map display

Shading display

StatusMonitor

Remote machine monitoring



Off-line measurement procedure programming function

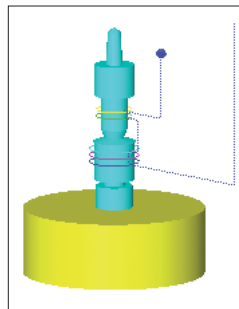

An offline teaching function is provided to create a part program (measurement procedure) without an actual measurement target, enabling the user to virtually execute the measurement operation in a 3D simulation window. You can also display warnings* about the risk of collision in the simulation window.

*This function is for **RA-H5200 PLUS** only.

MitutoyoLauncher support

Quick Launcher is provided as a standard feature. This enables simple and intuitive operation, so part programs can be run easily. Part programs can also be run by scanning barcodes or QR codes.

Harmonic tolerance verification / Velocity analysis

Analysis of bearing sliding surfaces is provided as a standard feature.

Harmonic analysis result (Roundness (Round_15))

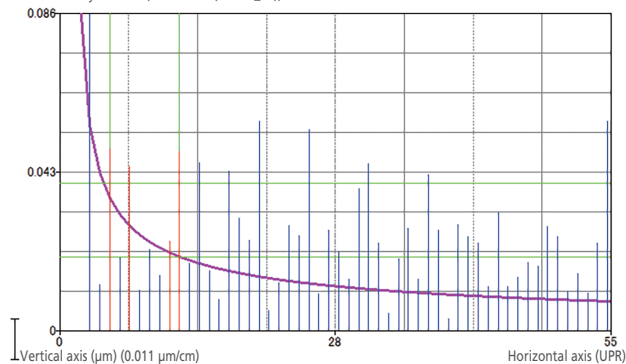

Velocity analysis result (Roundness (Round_15))

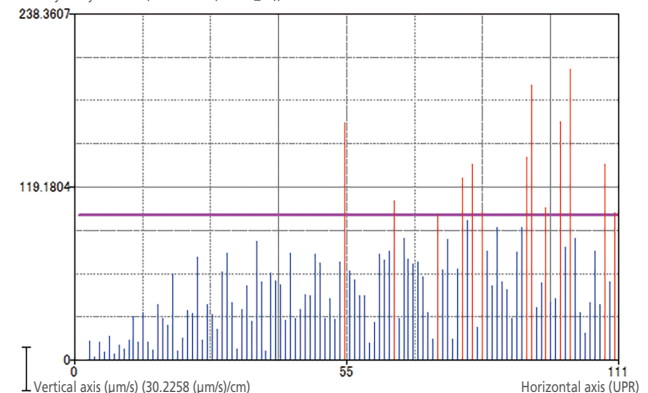

Options

Styli for RA-H5200AS/AH (Option)

Unit: mm
25.4mm=1"

Type	Standard (Standard accessory)	Notch	Deep groove	Corner	Cutter mark
Order No.	12AAL021	12AAL022	12AAL023	12AAL024	12AAL025
Stylus tip	ø 1.6 mm tungsten carbide	ø 3 mm tungsten carbide	SR0.25 mm sapphire	SR0.25 mm sapphire	tungsten carbide
Dimensions (mm)					
Type	Small hole (ø 0.8)	Small hole (ø 1.0)	Small hole (ø 1.6)	Extra small hole (Depth 3 mm)	ø 1.6 mm ball
Order No.	12AAL026	12AAL027	12AAL028	12AAL029	12AAL030
Stylus tip	ø 0.8 mm tungsten carbide	ø 1 mm tungsten carbide	ø 1.6 mm tungsten carbide	ø 0.5 mm tungsten carbide	ø 1.6 mm tungsten carbide
Dimensions (mm)					
Type	Disk	Crank (ø 0.5)	Crank (ø 1.0)	Flat surface	2X-long type *1
Order No.	12AAL031	12AAL032	12AAL033	12AAL034	12AAL035
Stylus tip	ø 12 mm tungsten carbide	ø 0.5 mm tungsten carbide (Depth 2.5 mm)	ø 1 mm tungsten carbide (Depth 5.5 mm)	tungsten carbide	ø 1.6 mm tungsten carbide
Dimensions (mm)					
Type	2X-long type notch *1	2X-long type deep groove *1	2X-long type corner *1	2X-long type cutter mark *1	2X-long type Small hole *1
Order No.	12AAL036	12AAL037	12AAL038	12AAL039	12AAL040
Stylus tip	ø 3 mm tungsten carbide	SR0.25 mm sapphire	SR0.25 mm sapphire	tungsten carbide	ø 1 mm tungsten carbide
Dimensions (mm)					
Type	3X-long type *1	3X-long type deep groove *1	Stylus shank	Stylus shank(standard groove)	Stylus shank(2X-long groove)*1
Order No.	12AAL041	12AAL042	12AAL043	12AAL044	12AAL045
Stylus tip	ø 1.6 mm tungsten carbide	SR0.25 mm sapphire	For mounting CMM stylus (mounting thread M2)	For mounting CMM stylus (mounting thread M2)	For mounting CMM stylus (mounting thread M2)
Dimensions (mm)					

*1: Measuring is only possible in the vertical direction.

Note A five-piece alternative stylus set (Order No. **12AAL020**) with five types of general-purpose optional styli (for notches, for grooves, for small holes (ø 1.0), ø 1.6 ball, and 2X-long) is also available.

Note that customized special interchangeable styli are available on request. Please contact any Mitutoyo office for more information.

Unit: mm
25.4mm=1"

Styli for RA-H5200 PLUS (Option)

Type	Deep groove	Flat surface	Standard	Notch	Deep hole A
Order No.	12AAE310	12AAE302	12AAE301	12AAE309	12AAE306
Stylus tip	ø 1.6 mm tungsten carbide	ø 1.6 mm tungsten carbide	ø 1.6 mm tungsten carbide	ø 3 mm tungsten carbide	ø 1.6 mm tungsten carbide
Dimensions (mm)					
Type	ø 1.6 mm ball	ø 0.8 mm ball	ø 0.5 mm ball	Deep groove	Deep hole B
Order No.	12AAE303	12AAE304	12AAE305	12AAE308	12AAE307
Stylus tip	ø 1.6 mm tungsten carbide	ø 0.8 mm tungsten carbide	ø 0.5 mm tungsten carbide	ø 1.6 mm tungsten carbide	ø 1.6 mm tungsten carbide
Dimensions (mm)					

Options common to the RA-H5200 SERIES

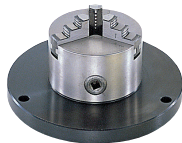

Centering chuck (key operated)

211-014

Suitable for holding longer parts and those requiring a relatively powerful clamp.

- Holding range:
Inner jaws: OD = ø2 - ø35 mm,
ID = ø25 - ø68 mm
Outer jaws: OD = ø35 - ø78 mm
- External dimensions: ø157 x 70.6 mm
- Mass: 3.8 kg



Centering chuck (ring operated)

211-032

Suitable for holding small parts with easy-to-operate knurled-ring clamping.

- Holding range:
Inner jaws: OD = ø1 - ø36 mm,
ID = ø16 - ø69 mm
Outer jaws: OD = ø25 - ø79 mm
- External dimensions (DxH):
ø118 x 41 mm
- Mass: 1.2 kg



Micro-chuck

211-031

Used for clamping a workpiece (less than ø1 mm dia.) that the centering chuck cannot handle.

- Holding range:
ø0.2 - ø1.5 mm
- External dimensions (DxH):
ø107 x 48.5 mm
- Mass: 0.6 kg

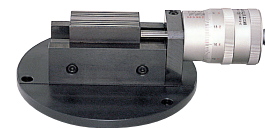

Magnification calibration gage

211-045

Used for normalizing detector magnification by calibrating detector travel against displacement of a micrometer spindle.

- Maximum calibration range: 400 µm
- Graduation: 0.2 µm
- External dimensions (WxDxH):
235 (max) x 185 x 70 mm
- Mass: 4 kg

Cylindrical square

350850

- Straightness: 1 µm
- Cylindricity: 2 µm
- External dimensions (DxH):
ø70 x 250 mm
- Mass: 7.5 kg

RA-H5200 Series Specifications / Dimensions

Specifications

Unit: mm
25.4mm=1"

Model No.		RA-H5200AS	RA-H5200AH	RA-H5200 PLUS		
Z-axis		Standard column	High column	Standard column	High column	
Turntable unit	Rotational accuracy	Radial direction	(0.02+3.5 H/10000) μm (H: probing height (mm))			
		Axial direction	(0.02+3.5X/10000) μm (X: distance from rotational center (mm))			
	Rotating speed		2,4,6,10 rpm (Auto centering: 20 rpm)			
	Table effective diameter		ø300 mm			
	Centering/leveling adjustment		A.A.T.			
	Centering adjustment range		±5 mm			
	Leveling adjustment range		±1 °			
	Max. lording weight		80 kg (Auto centering: 65 kg)			
	Max. probing diameter		ø400 mm		ø356 mm	
	Max. lording diameter		ø680 mm			
Vertical drive unit (Z-axis)	Straightness accuracy (λc2.5 mm)		0.05 μm/100 mm 0.14 μm/350 mm	0.05 μm/100 mm 0.2 μm/550 mm	0.05 μm/100 mm 0.14 μm/350 mm 0.2 μm/550 mm	
	Parallelism to rotation center (Reterential generattix line)		0.2 μm/350 mm	0.32 μm/550 mm	0.2 μm/350 mm 0.32 μm/550 mm	
	Traverse speed		Max. 60 mm/s (Measurement: 0.5/1.0/2.0/5.0 mm/s)			
	Vertical Travel amount		350 mm	550 mm	350 mm 550 mm	
	Max. probing height	ID/OD	350 mm	550 mm	350 mm 550 mm	
	Max. probing depth (with standard stylus)		85 mm for ø32 mm or more 50 mm for ø7 mm or more		104 mm for ø32 mm or more 26 mm for ø12.7 mm or more	
Radial drive unit (X-axis)	straightness accuracy		0.4 μm/200 mm (λc2.5 mm)			
	Horizontal to rotation center		0.5 μm/200 mm (Reterential generattix line)			
	Travel amount		225 mm (Including -25 mm travel from rotational center)			
	Travel speed		Max. 50 mm/s (Measurement: 0.5/1.0/2.0/5.0 mm/s)			
Detector	Measuring force		approx 10~50 mN (switching 5 levels)		approx 40 mN	
	Stylus design, material		ø1.6 mm tungsten carbide ball		ø1.6 mm tungsten carbide ball	
	Measuring range	Standard	±400 μm / ±40 μm / ±4 μm		±400 μm / ±40 μm / ±4 μm	
		Follow	±5 mm		±5 mm	
Other		In-out switching feature Measuring force switching feature (5-step) Collision detection function for Z-axis direction Stylus angle scale markings (±45 °)		Accidental touch function Measuring direction: 1		
Other	Power supply		100 V~240 V			
	Air pressure		0.39 MPa			
	Air consumption		45 L/min (Standard state) (Air supply of 80 L/min or higher)			
	Weight (measurement main unit)		650 kg	670 kg	650 kg 670 kg	
	Weight (vibration isolator)		170 kg			

Dimensions

Unit: mm
25.4mm=1"

RA-H5200AS/AH

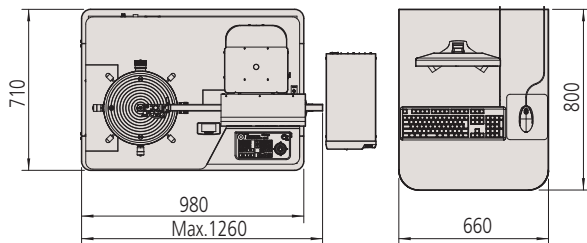

RA-H5200 PLUS

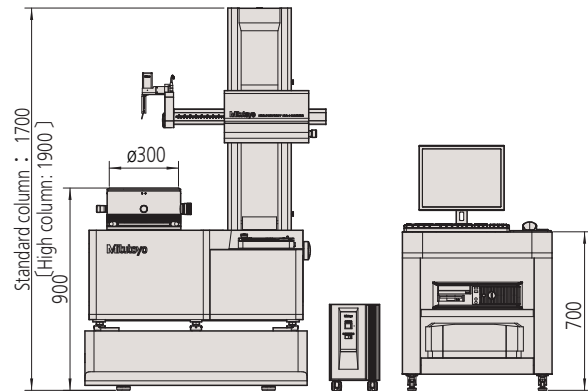
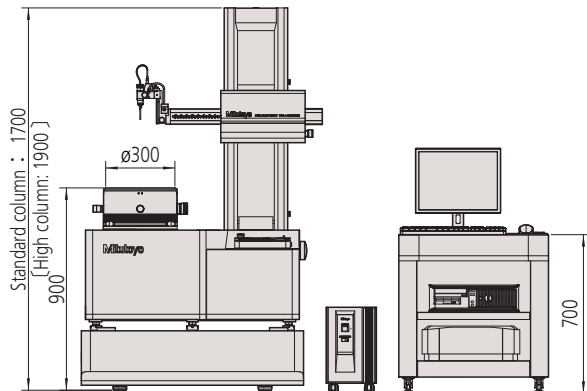
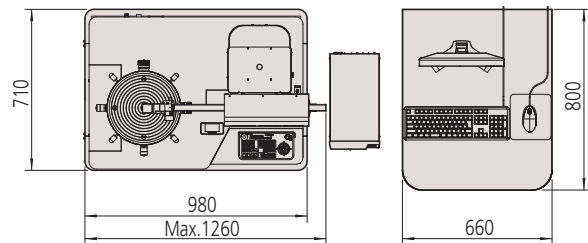

Note: Side table (PC table) is an option.

Coordinate Measuring Machines

Vision Measuring Systems

Form Measurement

Optical Measuring

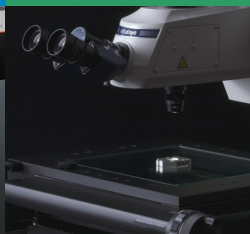
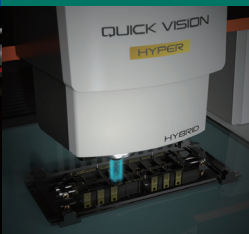

Whatever your challenges are, Mitutoyo supports you from start to finish.

Mitutoyo is not only a manufacturer of top quality measuring products but one that also offers qualified support for the lifetime of the equipment, backed up by comprehensive services that ensure your staff can make the very best use of the investment.

Apart from the basics of calibration and repair, Mitutoyo offers product and metrology training, as well as IT support for the sophisticated software used in modern measuring technology. We can also design, build, test and deliver measuring solutions and even, if deemed cost-effective, take your critical measurement challenges in-house on a sub-contract basis.

Sensor Systems

Test Equipment

Digital Scale and DRO Systems

Small Tool Instruments and Data Management

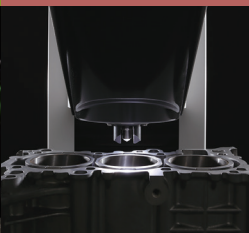

My.Mitutoyo

Mitutoyo End User Portal

Search for products, request a product quote, take online metrology courses, and much more.

My.Mitutoyo.com puts everything Mitutoyo directly in front of you.



Find additional product literature and our product catalog

www.mitutoyo.com

Note: All information regarding our products, and in particular the illustrations, drawings, dimensional and performance data contained in this printed matter as well as other technical data are to be regarded as approximate average values. We therefore reserve the right to make changes to the corresponding designs. The stated standards, similar technical regulations, descriptions and illustrations of the products were valid at the time of printing. In addition, the latest applicable version of our General Trading Conditions will apply. Only quotations submitted by ourselves may be regarded as definitive. Specifications are subject to change without notice.

Mitutoyo products are subject to US Export Administration Regulations (EAR). Re-export or relocation of our products may require prior approval by an appropriate governing authority.

Trademarks and Registrations

Designations used by companies to distinguish their products are often claimed as trademarks. In all instances where Mitutoyo America Corporation is aware of a claim, the product names appear in initial capital or all capital letters. The appropriate companies should be contacted for more complete trademark and registration information.

Mitutoyo

Mitutoyo America Corporation

www.mitutoyo.com

One Number to Serve You Better

1-888-MITUTOYO (1-888-648-8869)

M³ Solution Centers:

Aurora, Illinois (Headquarters)

Boston, Massachusetts

Charlotte, North Carolina

Cincinnati, Ohio

Detroit, Michigan

Los Angeles, California

Seattle, Washington

Houston, Texas