

Compact Roundness Measurement ROUNDTEST RA-120/120P

Bulletin No. 2138



Compact roundness tester equipped with a wide range of analysis features and capable of accommodating a variety of workpieces

Mitutoyo

Roundtest RA-120

- Best-in-class rotational accuracy in compact type roundness measuring instruments
- Fine adjustment on both X- and Z-axes
- Multiple analyses through simple operation
- D.A.T. function *except for centering/leveling device: Analog mic-head type
- Scaled Z-axis
- Continuous ID and OD measurement
- High-precision air bearing
- Wide-range detector
- Simple setup and display of results
- Built-in printer
- Supports 16 languages



Simple, interactive display screen

The large color LCD screen with backlight shows easy-to-understand measurement results and graphs. Forms can be checked and notch processing can be set while observing the displayed graphs.

Measurement screen

- Set the position of the detector and measurement conditions here
- During measurement, graphs are displayed in real time

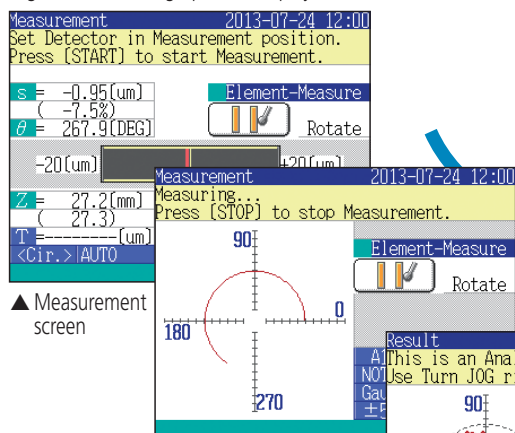

▲ Measurement screen

▲ Measurement in progress screen

Measurement results

- Filter, display magnification, etc., can be altered
- Besides circles, development views can also be displayed

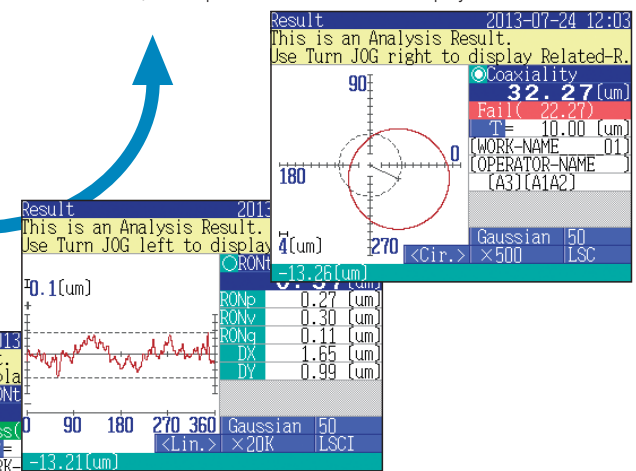

Result screen ▲

This compact roundness measuring machine includes numerous features that are user-friendly such as a wider range for the detector, an easy-to-understand operation panel with large color LCD, a D.A.T. function for centering and leveling adjustments, and many others.

Operating panel that is read at a glance

Supports 16 languages

Japanese, English, German, French, Italian, Spanish, Portuguese, Korean, Traditional Chinese, Simplified Chinese, Czech, Polish, Hungarian, Turkish, Swedish, Dutch

Analysis type

Selection buttons provide access to a wide variety of analysis types

Switching screen modes

Switch the display at the touch of a button, providing access to the [Calibration], [Centering and Leveling], [Measurement], and [Result] screens.

Zero-setting button

No fine adjustment necessary for setting the measurement position

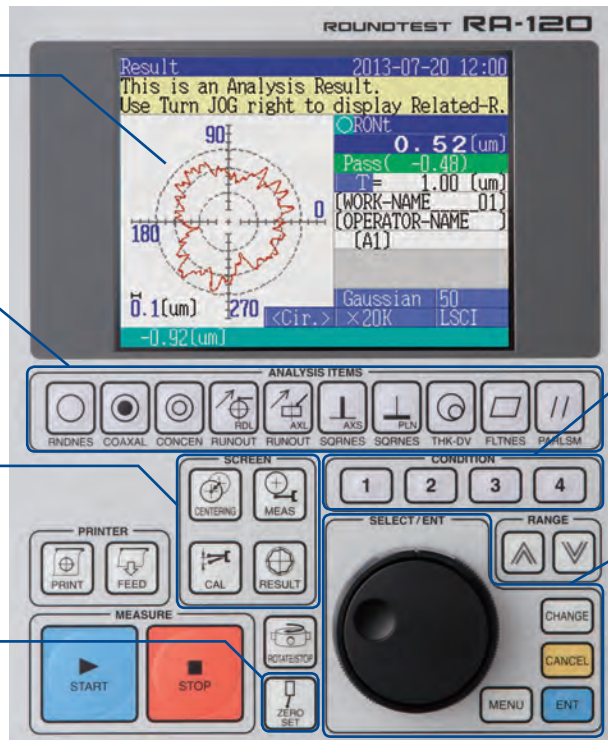

Simple setup

Apply the current measurement setup in one step
Simple operation helps prevent operational errors

Jog dial

Make detailed changes to setup conditions and other operations

Simplified communication program for ROUNDTEST RA-120

The Roundtest RA-120 has a USB interface, enabling data to be transferred to a spreadsheet or other software.

Notch processing

Unwanted data, such as that produced by notches or scratches, can be excluded from the analysis if desired. Select between [Automatic setting] and [Arbitrary setting].

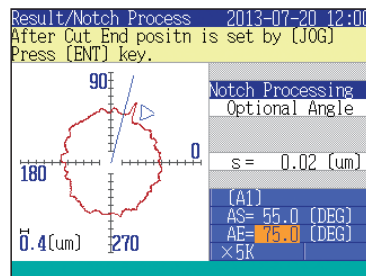

File save

Save and access [Measurement files] and [Result files] in USB memory. Data can also be totaled using the data output function with commercial tabulation software.

[Measurement file] [Measurement data (Data output)]
[Result file] [Result data (Data output)]

High-grade thermal printer

Print measurement conditions, computation results, result graphs, comments, etc., to the thermal printer. Change development graphs and output items as desired.

Sample prints

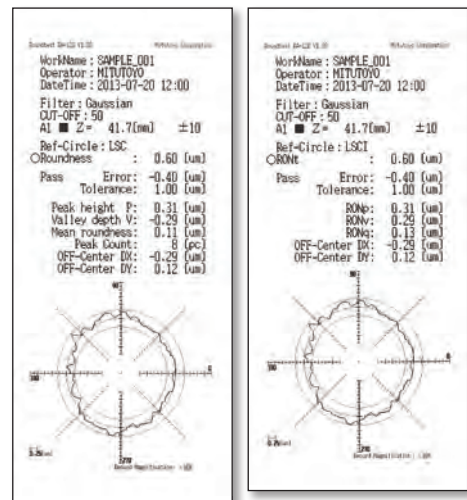

Recording paper set (optional set of 10 rolls)

Roundtest RA-120P

- Best-in-class rotational accuracy in the Compact Type Roundness Measuring Instruments
- Fine adjustment on both X- and Z-axes
- Multiple analyses through simple operation
- D.A.T. function
*except for centering/leveling device: Analog mic-head type
- Scaled Z-axis
- Continuous ID and OD measurement
- Display function for various graphs
- High-precision air bearing
- Wide-range detector
- Supports 15 languages

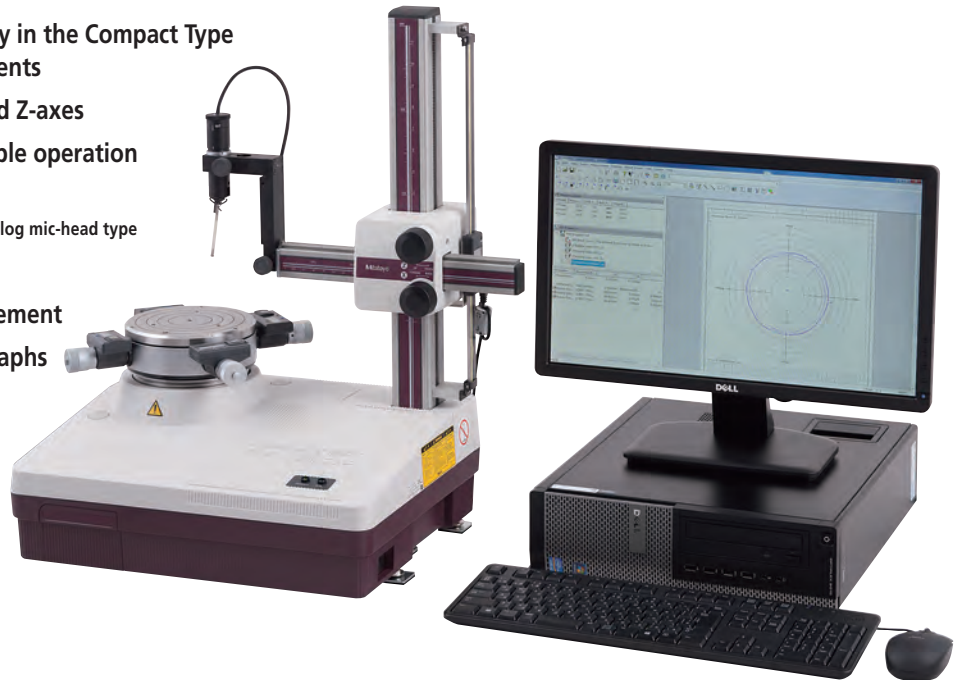

Windows graphical interface

By using a mouse and buttons, identified by corresponding icons, to control the machine, the Roundtest RA-120P's interface provides excellent usability. Functions such as recalculation and graph reading are handled swiftly with easy-to-understand operations.

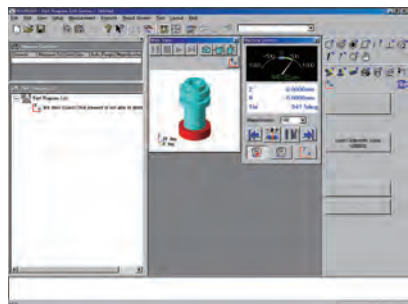

▲ Main screen

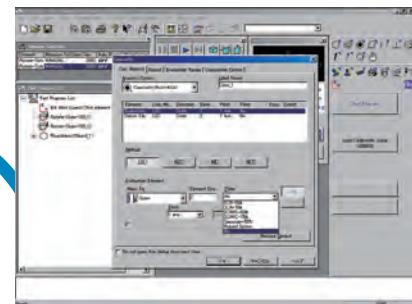

▲ Measurement setup screen

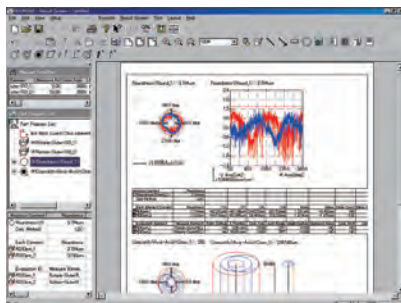

▲ Result screen



▲ Measurement in progress screen

This entry-level desktop tester incorporates the ROUNDPAK multi-analysis evaluation program, which provides it with analytical power close to that of more elaborate models. This is, therefore, a highly functional multi-analysis roundness measuring machine that is suitable for use not only in measurement rooms, but also in research and development sections.

Measurement screen makes ample use of graphs

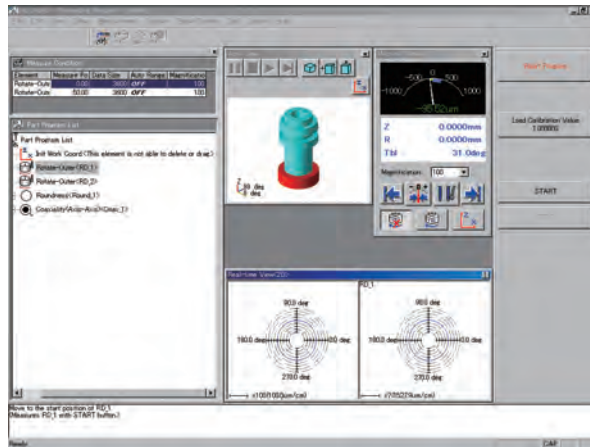

Multi-analysis function

Complete with a wide range of functions including partial enlargement, auxiliary line setup, color change, displacement/angular difference of data between two points. Also equipped with notch processing and graph reading functions, which make the machine useful in research departments. Recalculation can also be performed when the filter and evaluation method is changed.

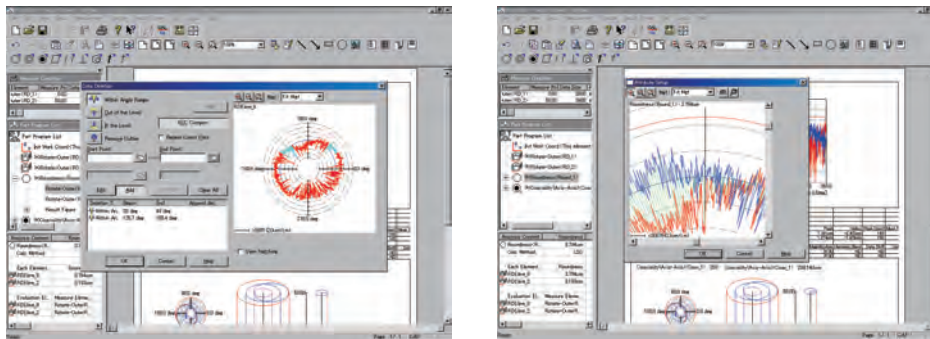

Simplified layout function

Computation results for multiple items can be laid out in multiple forms on a single sheet and printed. This function also supports output to a color printer (optional).

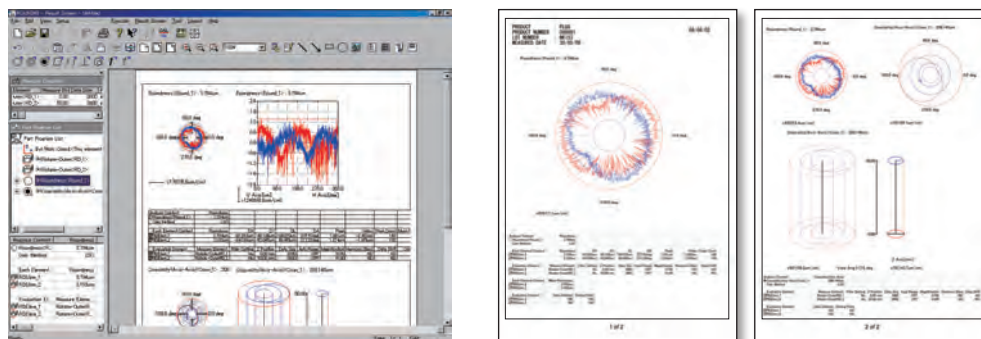

■ Layout setting screen

■ Sample print outputs

Functions that implement greater efficiency of measurement and range of analysis types

D.A.T. function *except for centering/leveling device (analog micrometer heads)

This instrument uses the D.A.T. (Digital Adjustment Table) function available on higher-end models, and this provides powerful support for centering and leveling operations. To perform such operations, the user need only adjust the digital micrometer heads attached to the rotary table by the amounts indicated on the display. This function also supports measurement of notched workpieces.

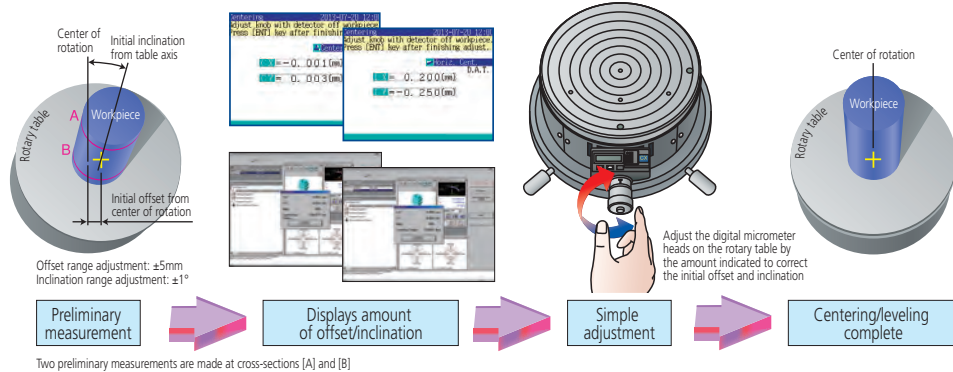
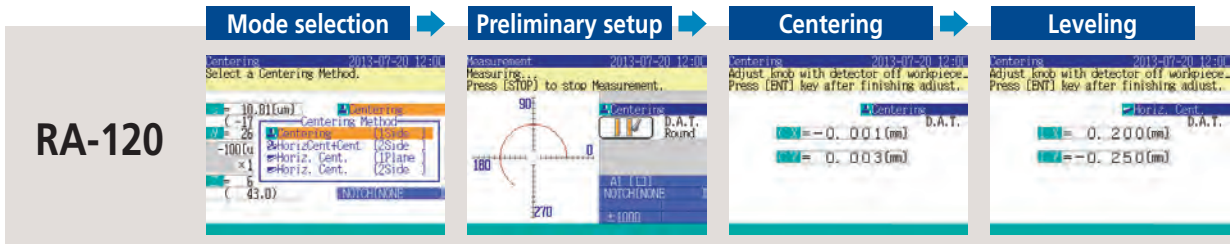

Continuous ID and OD measuring function

This function comes in very handy when outside diameter and inside diameter surfaces need to be measured repeatedly, for example, with respect to coaxiality, deviation in wall thickness, etc. The inner surface can be measured and evaluated with the detector, maintaining the same measuring position for the outside diameter without changing its orientation, as illustrated on the right. Inside diameters as small as 50mm can be measured.



Continuous inside and outside diameter function (inside dia. surface)

Continuous inside and outside diameter function (outside dia. surface)

Z-axis scale

This scale is useful when the measuring height position needs to be entered, such as when measuring coaxiality, etc. The machine uses an ABS Digimatic scale unit to provide an effective means for repetitive measurement and position setting.



IN/OUT switchable wide-range detector

The range of this detector has been extended from that of a conventional lever head by as much as four times, and is now wider than ever before. The detector can provide sufficient margin for centering and leveling jobs, or when measuring large differences. Moreover, the measuring direction can be switched between inside and outside diameters with the rotary selector located on the top of the detector.

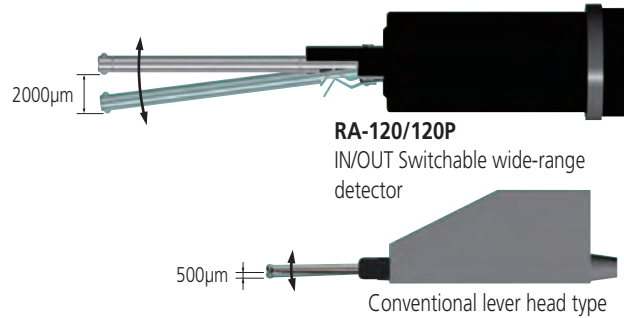

Types of Analysis

Type of Analysis	Measurement mode	Evaluation diagram	RA-120	RA-120P
Roundness			<input type="checkbox"/>	<input type="checkbox"/>
Flatness			<input type="checkbox"/>	<input type="checkbox"/>
Squareness	Relative to Axis		<input type="checkbox"/>	<input type="checkbox"/>
	Relative to Plane		<input type="checkbox"/>	<input type="checkbox"/>
Concentricity			<input type="checkbox"/>	<input type="checkbox"/>
Coaxality	Of section		<input type="checkbox"/>	<input type="checkbox"/>
	Of axis		<input type="checkbox"/>	<input type="checkbox"/>

Type of Analysis	Measurement mode	Evaluation diagram	RA-120	RA-120P
Parallelism			<input type="checkbox"/>	<input type="checkbox"/>
Thickness variation	Radial		<input type="checkbox"/>	<input type="checkbox"/>
	Axial		<input type="checkbox"/>	<input type="checkbox"/>
Circular run-out	Radial		<input type="checkbox"/>	<input type="checkbox"/>
	Axial		<input type="checkbox"/>	<input type="checkbox"/>
Power spectrum			<input type="checkbox"/>	<input type="checkbox"/>
Profile operation			<input type="checkbox"/>	<input type="checkbox"/>

Optional Accessories

Interchangeable Styli

Unit: inch (mm)

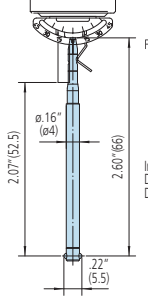
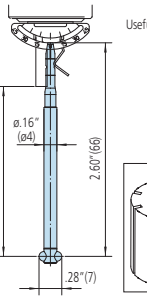
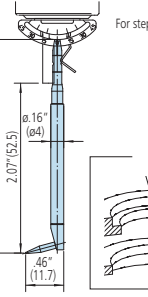
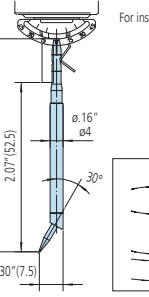
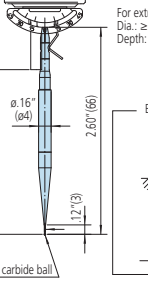
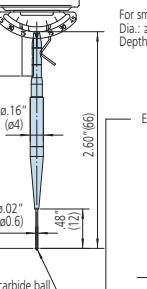
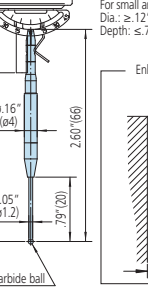
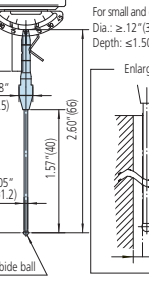
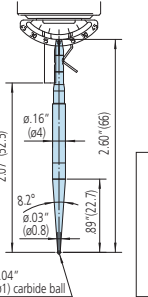
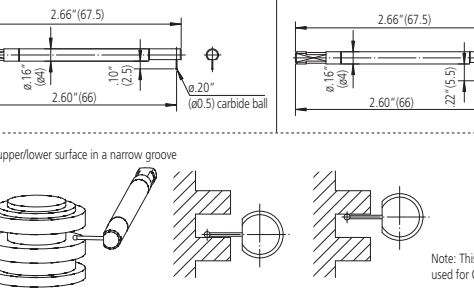
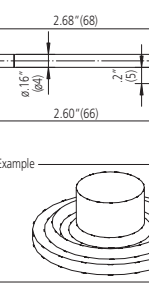
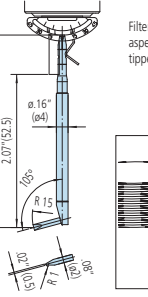
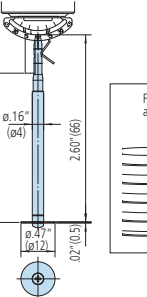
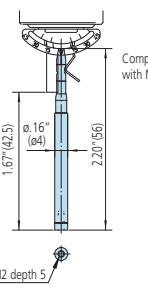
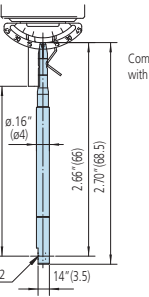
12AAL021 Standard stylus *Standard accessory (stylus tip: $\phi 0.06''$ ($\phi 1.6$) carbide ball)	12AAL022 Stylus for notched workpieces (stylus tip: $\phi 0.12''$ ($\phi 3$) carbide ball)	12AAL023 Stylus for deep groove (stylus tip: R0.01''(.25) sapphire)	12AAL024 Stylus for corners (stylus tip: R0.01''(.25) sapphire)
 <p>For standard applications</p> <p>In ID measurement Dia.: $\geq 30''$(7.5mm), Depth: $\geq 1.97''$(50mm)</p>	 <p>Useful for notched workpieces</p> <p>Example</p>	 <p>For stepped applications</p> <p>Example</p>	 <p>For inside-corner applications</p> <p>Example</p>
12AAL029 Stylus for extra small holes (stylus tip: $\phi 0.02''$ ($\phi 0.5$) carbide ball)	12AAL026 Stylus for small holes (stylus tip: $\phi 0.03''$ ($\phi 0.8$) carbide ball)	12AAL030 Stylus for small and deep holes (stylus tip: $\phi 0.6''$ ($\phi 1.6$) carbide ball, L=20)	12AAL028 Stylus for small and deep holes (stylus tip: $\phi 0.6''$ ($\phi 1.6$) carbide ball, L=40)
 <p>For extra small hole applications Dia.: $\geq 0.4''$(1mm), Depth: $\leq 1.0''$(2.5mm)</p> <p>Enlarged image</p> <p>$\phi 0.02''$($\phi 0.5$) carbide ball</p>	 <p>For small hole applications Dia.: $\geq 0.6''$(1.5mm), Depth: $\leq 0.39''$(10mm)</p> <p>Enlarged image</p> <p>$\phi 0.03''$($\phi 0.8$) carbide ball</p>	 <p>For small and deep hole applications Dia.: $\geq 1.2''$(3mm), Depth: $\leq 0.71''$(18mm)</p> <p>Enlarged image</p> <p>$\phi 0.6''$($\phi 1.6$) carbide ball</p>	 <p>For small and deep hole applications Dia.: $\geq 1.2''$(3mm), Depth: $\leq 1.50''$(38mm)</p> <p>Enlarged image</p> <p>$\phi 0.6''$($\phi 1.6$) carbide ball</p>
12AAL027 Stylus for small holes (stylus tip: $\phi 0.04''$ ($\phi 1$) carbide ball)	12AAL032 Crank stylus (stylus tip: $\phi 0.02''$ ($\phi 0.5$) carbide ball)	12AAL033 Crank stylus (stylus tip: $\phi 0.04''$ ($\phi 1$) carbide ball)	12AAL034 Stylus for flat surface
 <p>Example</p> <p>$\phi 0.04''$($\phi 1$) carbide ball</p>	 <p>For upper/lower surface in a narrow groove</p> <p>Note: This stylus cannot be used for OD/ID measurement.</p>	 <p>Example</p>	
12AAL025 Stylus for removing asperities (machining marks)	12AAL031 Disk stylus	12AAL043 M2 tapped stylus shank for CMM styli	12AAL044 M2 tapped stylus shank for CMM styli
 <p>Filtering out the effects of asperities by tracing with R15 tipped stylus</p> <p>Example</p> <p>Machining marks</p>	 <p>Example</p> <p>For narrow groove applications</p>	 <p>Compatible with CMM styli with M2 threaded shank</p> <p>M2 depth 5</p>	 <p>Compatible with CMM styli with M2 threaded shank</p>

Centering chuck (knurled ring operated)

Provides good operability when measuring a small-diameter workpiece. The knurled ring allows the workpiece to be clamped easily.



Order No.	211-032
Holding range	OD with internal jaws 1–36 mm ID with internal jaws 16–69 mm OD with external jaws 25–79 mm
External size (DxH)	ø 4.65" x 1.6" (118 x 41 mm)
Mass	2.6 lbs (1.2 kg)

Collet chuck

Provides high clamping repeatability due to the use of optional precision collets. (See table at right.)



Order No.	211-051
Part holding range	ø0.5–10 mm* ²
Centering error	Within 50 µm* ³
Mass	3 lbs (1.4 kg)

*2: Collets to match the workpiece size range are required for use with this chuck.

*3: When measured with ø5 mm pin gauge at measuring height of 30 mm.

X-axis stop

Allows the user to return the detector rapidly and easily to a fixed position in the X axis.



Order No.	12AAH320
Mass	.14 lbs (65g)

Three-jaw chuck (key operated)

Useful where it is necessary to apply a higher clamping force to the workpiece than can be applied with the centering chuck.



Order No.	211-014
Holding range	OD with internal jaws 2.35–26 mm ID with internal jaws 25–68 mm OD with external jaws 35–78 mm
External size (DxH)	ø 6.18" x 2.78" (157 x 70.6 mm)
Mass	8.4 lbs (3.8 kg)

Individual collets*⁴

These collets are for use with the collet chuck shown at left and are acquired to match the workpiece diameter range required.

Order No.	Part Holding Range (O.D.)
12AAH402	ø0.02"–0.04" (0.5–1.0mm)
12AAH403	ø0.04"–0.06" (1.0–1.5mm)
12AAH404	ø0.06"–0.08" (1.5–2.0mm)
12AAH405	ø0.08"–0.1" (2.0–2.5mm)
12AAH406	ø0.1"–0.12" (2.5–3.0mm)
12AAH407	ø0.12"–0.138" (3.0–3.5mm)
12AAH408	ø0.0.138"–0.157" (3.5–4.0mm)
12AAH409	ø0.157"–0.197" (4.0–5.0mm)
12AAH410	ø0.197"–0.236" (5.0–6.0mm)
12AAH411	ø0.236"–0.275" (6.0–7.0mm)
12AAH412	ø0.275"–0.315" (7.0–8.0mm)
12AAH413	ø0.315"–0.354" (8.0–9.0mm)
12AAH414	ø0.354"–0.394" (9.0–10.0mm)

*4: A collet cannot be mounted on the rotary table without a collet chuck.
*4: YCC10-** Class AA, made by Yukiwa Seiko Inc. or its equivalent.

Vibration-damping stand

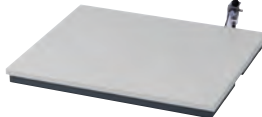

Order No.	211-013
Vibration damping system	Diaphragm type air spring
External size	24 x 20 x 2" (615 x 515 x 51mm)
Max. loading mass	330 lbs (150kg)

Microchuck

For clamping a small workpiece, 1 mm or less in diameter, that cannot be held in the centering chuck.



Order No.	211-031
Holding range	OD: 0.1–1.5 mm
External size (DxH)	ø4.65" x 1.9" (118 x 48.5 mm)
Mass	1.32 lbs (0.6 kg)

Auxiliary stage for a short workpiece

Order No. 356038

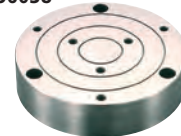

Reference hemisphere

Order No. 211-016



Magnification checking gage

Order No. 211-045



Gage block set for calibration

Order No. 997090

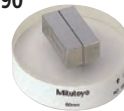

Replacement elements for the air filter

Order No. 358592 (for filter)
358593 (filter regulator)

Simplified communication program for ROUNDTEST RA-120

The Roundtest RA-120 has a USB interface, enabling data to be transferred to a spreadsheet or other software. We also provide a program that lets you create inspection record tables using a Microsoft Excel* macro.

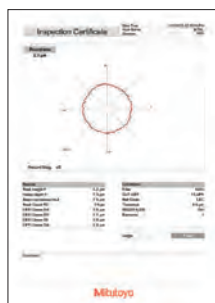

Required environment:

- OS: Windows XP-SP3
- Spreadsheet software: Microsoft Excel 2010
- Windows 7 (32/64 bit)

*Windows OS and Microsoft Excel are products of Microsoft Corporation.

The optional USB cable is also required.

- USB cable for RA-120 series
- Order No. 12AAH490

This program can be downloaded free of charge from the Mitutoyo website.
<http://www.mitutoyo.com>

Specifications

■ Main unit

Model		RA-120		RA-120P		
Order No.*		211-544A	211-543A	211-547A	211-546A	
Turntable	Rotational accuracy	Radial	(0.04+6H/10000)μm H: Probing height (mm) JIS B 7451-1997			
		Axial	(0.04+6X/10000)μm X: Probing radius (mm)			
	Rotation speed	6 rpm				
	Effective table diameter	ø6" (150mm)				
	Centering range adjustment	±.118" (3mm)				
	Leveling range adjustment	±1°				
	Centering/leveling device (micrometer head)	Mechanical head	Digital head (inch/mm)	Mechanical head	Digital head (inch/mm)	
	Maximum probing diameter	±11"(280mm) [(±15" (380mm) in a reverse and vertical detector position)]				
	Maximum workpiece diameter	17.32" (440mm)				
	Maximum turntable loading	55 lbs (25kg)				
Vertical column (Z-axis)	Vertical travel	11.02" (280mm) from the turntable top				
	Maximum probing height	280mm from the turntable top [(18.9" (480mm) in the reverse and vertical detector configuration)]				
	Maximum probing depth	3.94" (100mm) [(minimum ID: ø1.12" (30mm)]				
Horizontal arm (X-axis)	Horizontal travel	6.5" (165mm) [(Including a protrusion of 1" (25mm) from the turntable rotation center)]				
Detector	Measuring direction	Two directional (IN/OUT switchable)				
	Measuring range	±1000μm				
	Measuring force	100mN (±30%)				
	Standard stylus (12AAL021)	Carbide ball, .06" (ø1.6mm)				
Electronic unit	Measuring range	±1000 ±500 ±200 ±100 ±50 ±20 ±10 ±5μm (8 steps)				
	Magnification	X5 to X200,000		X1 to X500,000		
	Filter type	Phase corrected: Gaussian, 2CRPC75, 2CRPC50		Not phase corrected: 2CR75, 2CR50 Filter OFF		
	Cutoff value	15upr, 50upr, 150upr, 500upr 15-150upr, 15-500upr, 50-500upr		15upr, 50upr, 150upr, 500upr, Manual 15-150upr, 15-500upr, 50-500upr, Manual		
	Number of measuring sections	Maximum 5		Maximum 100		
	Evaluation type	Roundness, coaxiality, concentricity, flatness, circular run-out (radial/axial), squareness (relative to axis/plane), thickness deviation, parallelism				
	Reference circle for evaluation	LSC, MZC, MIC, MCC				
	Adjusting centering/leveling	D.A.T. function (circular/multi-point switchable)				
	Functions	Notched measurement, re-calculation, limaçon error correction, continuous ID and OD measurement		Notched measurement, re-calculation, limaçon error correction, remarkable point analysis (gear), harmonic analysis, continuous ID and OD measurement		
	Printer	Thermal line printer (external printer port available)		Windows compatible ink-jet printer		
	Data output	USB stick memory	Calculation result, measurement data			
		RS-232C	Calculation result, measurement data			
		SPC	Calculation result			
Others	Power supply	AC 100 – 240V				
	Power consumption	40W		30W (excluding PC system)		
	Air pressure	390kPa				
	Air consumption	30L/min (minimum)				
	Mass	Main unit: 70.5 lbs (32kg) Air filter: 4.4 lbs (2kg)				

Dimensions

External dimensions

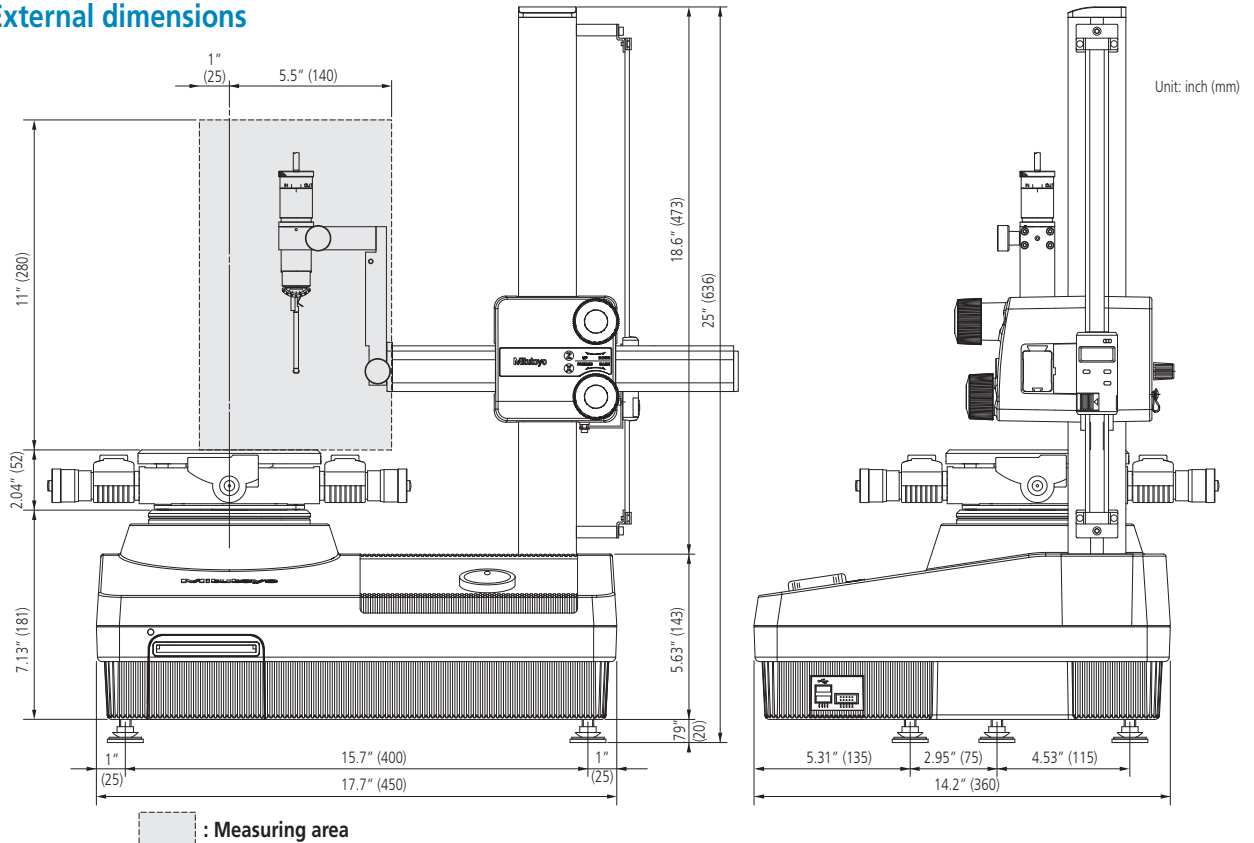

Turntable top view

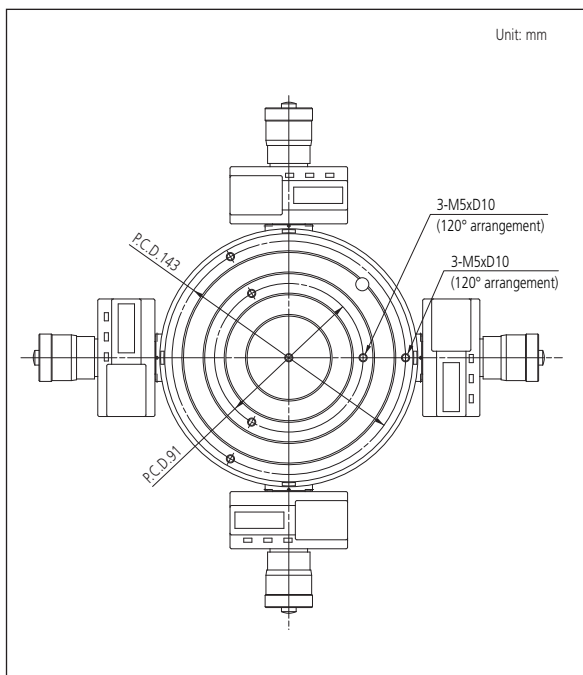

Installation floor plan

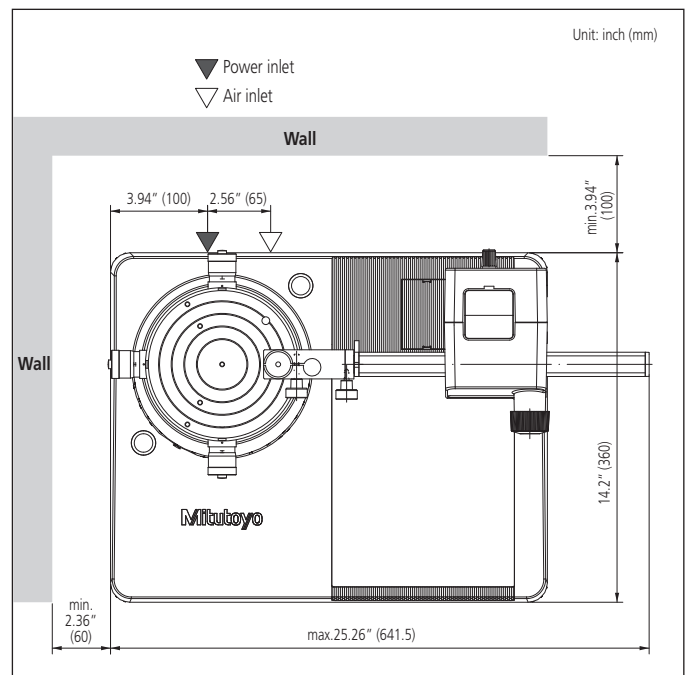



Coordinate Measuring Machines

Vision Measuring Systems

Form Measurement

Optical Measuring

Sensor Systems

Testing Equipment and
Seismometer

Digital Scale and DRO Systems

Small Tool Instruments and
Data Management

Note: All information regarding our products, and in particular the illustrations, drawings, dimensional and performance data contained in this printed matter as well as other technical data are to be regarded as approximate average values. We therefore reserve the right to make changes to the corresponding designs. The stated standards, similar technical regulations, descriptions and illustrations of the products were valid at the time of printing. In addition, the latest applicable version of our General Trading Conditions will apply. Only quotations submitted by ourselves may be regarded as definitive.

Mitutoyo products are subject to US Export Administration Regulations (EAR). Re-export or relocation of our products may require prior approval by an appropriate governing authority.

Trademarks and Registrations

Designations used by companies to distinguish their products are often claimed as trademarks. In all instances where Mitutoyo America Corporation is aware of a claim, the product names appear in initial capital or all capital letters. The appropriate companies should be contacted for more complete trademark and registration information.

Mitutoyo America Corporation
www.mitutoyo.com

One Number to Serve You Better
1-888-MITUTOYO (1-888-648-8869)

M³ Solution Centers

- Aurora, Illinois**
(Corporate Headquarters)
- Westford, Massachusetts**
- Huntersville, North Carolina**
- Mason, Ohio**
- Plymouth, Michigan**
- City of Industry, California**
- Birmingham, Alabama**
- Renton, Washington**

Mitutoyo
Precision is our Profession