

Mitutoyo

Mitutoyo Quality

Contour and Surface Roughness Measuring System FORMTRACER CS-3300 Series

Form Measurement



Catalog No. E15029

A Rich Choice of Functions to Enhance Your Measurement Efficiency

Featuring a wide measuring range and high-resolution detector, many kinds of measurement from contours to surface roughness are covered. Single-unit measurement reduces setup labor and measurement time.

Wide measuring range and high-resolution detector

Measuring range (Z axis): 5 mm (80 nm resolution) to 0.05 mm (0.8 nm resolution)

Accuracy (Z axis): $\pm (1.5+|2H|/100) \mu\text{m}$, H = Height from horizontal plane (mm)



● Conventional measurements...

STEP 1 Contour measurement **STEP 2** Surface roughness measurement



with CS-3300

Surface roughness measurement involves setting up the machine again with a different detector.

Enhanced Measurement Efficiency



Single setup and single tracing - no detector change

● Conventional measurement rooms needed...

Contour measuring instrument

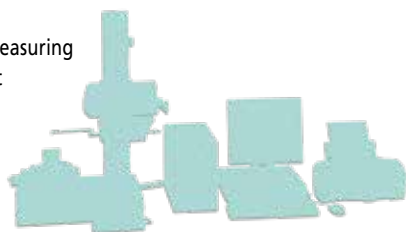

Surface roughness measuring instrument

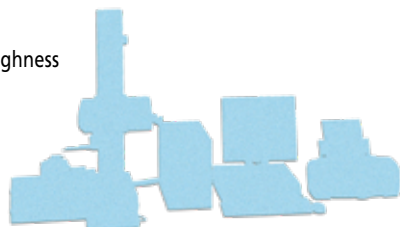

with CS-3300

Space for 2 measuring instruments, in addition to 2 PCs and 2 printers.

Space-saving



Space for just a single measuring instrument

● Conventional printed results...

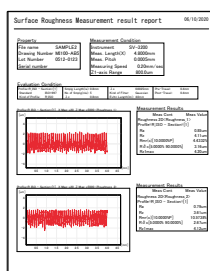
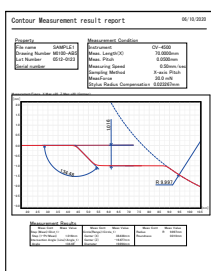

with CS-3300

Contour measuring instrument and surface roughness measuring instrument print measurement data individually.

Resource-saving

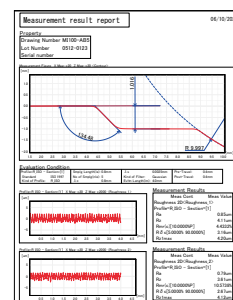

One inspection certificate printed with a minimum amount of paper, using a single printer and reducing energy requirements

Highly accurate linear encoders on X/Z2 axis

The drive unit (X axis) and column (Z2 axis) are equipped with high-accuracy linear scales (ABS type) enabling fully automatic measurement combining vertical and horizontal movement. This improves reproducibility of continuous automatic measurement of small holes in the vertical direction and repeated measurement of parts which are difficult to position.

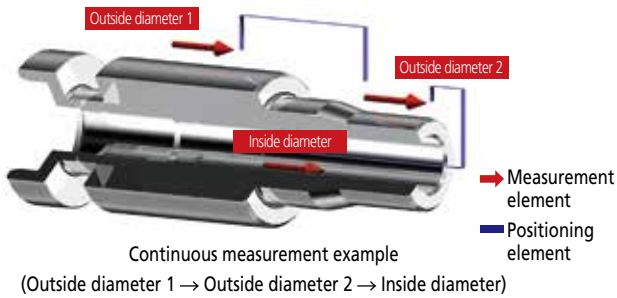

Improved measurement efficiency

Dramatically increased drive speed (X axis: 80 mm/s, Z2 axis: 30 mm/s) further reduces total measurement time. Small holes can be efficiently measured using the fine-feed knobs on the X and Z2 axes.



Small hole measurement example



Y- and Z-axis positioning using column (Z2 axis) fine-feed knob or cross-travel table (optional)



Measurement start positioning by (X axis) fine-feed knob

Sophisticated design

The detector unit can be extended to avoid interference between the drive unit and workpiece.

All detector and drive unit cables are housed inside the main unit to eliminate any risk of abrasion and guarantee trouble free, high-speed operation.



Drive unit tilting function and air vibration-damping stand are standard features

Drive unit (X axis) tilting function powerfully supports measurements on inclined planes and for heavy workpieces that are not easily moved.



Software, FORMTRACEPAK

FORMTRACEPAK provides a wide range of support, including measuring instrument control, contour analysis, surface roughness analysis, design data creation, contour verification, and inspection certificate creation functions!

Various functions are available to meet the needs of every department, including simplified repetitive measurements conducted by inspection departments and thorough pursuit of surface texture enhancement by R&D departments.

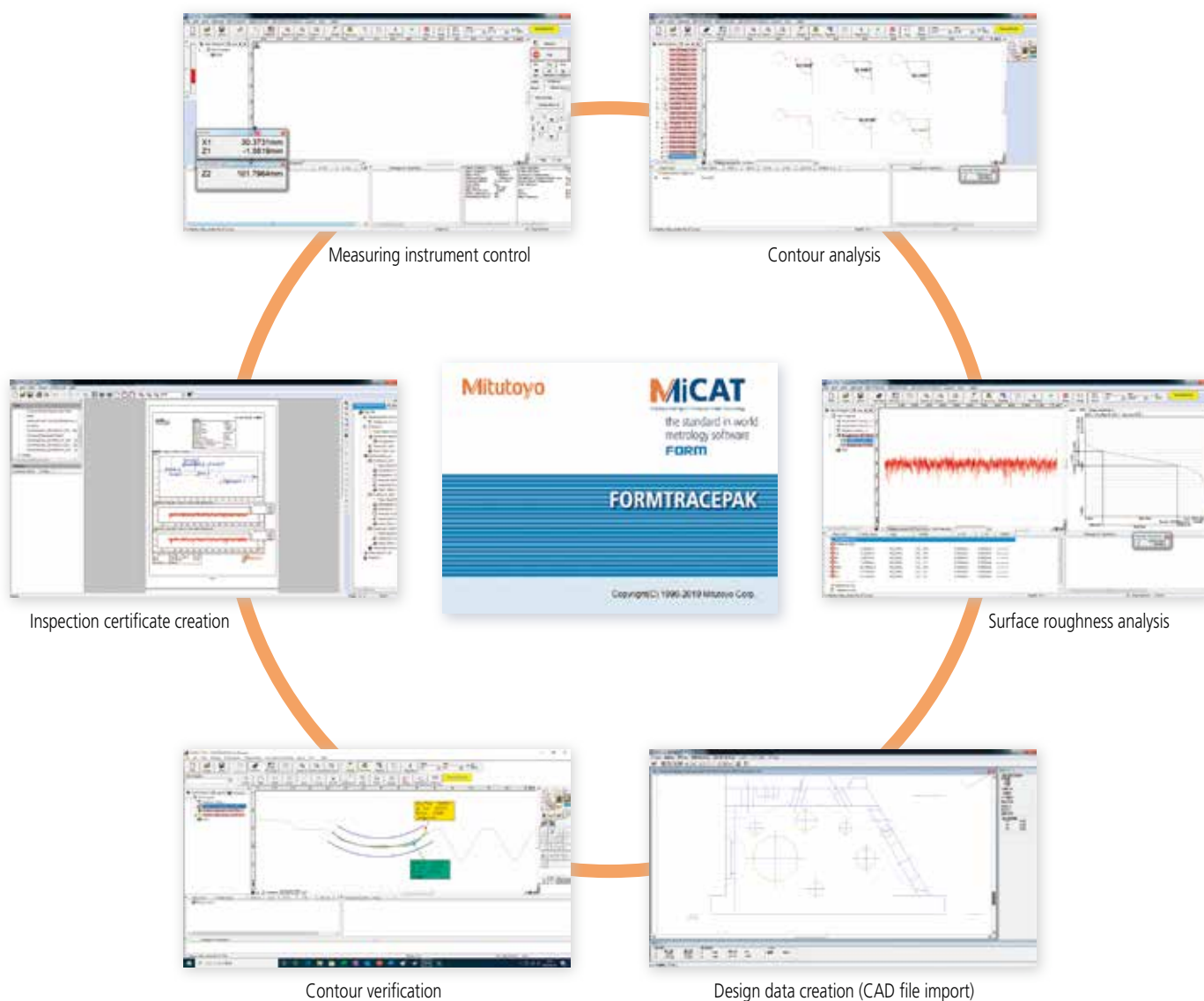

Optional Accessories for Automatic Measurement

Y-axis table 178-097

Enables efficient, automatic measurement of multiple aligned workpieces and multiple points on a single surface.

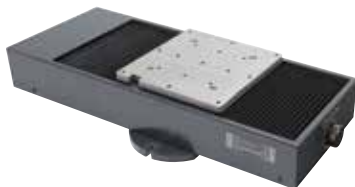

Travel range	200 mm
Resolution	0.05 μm
Positioning accuracy	$\pm 3 \mu\text{m}$
Drive speed	MAX 80 mm/s
Maximum load	50 kg
Mass	28 kg



Rotary table $\theta 1$ -axis table 12AAD975

For efficient measurement in the axial/transverse directions. When measuring a cylindrical workpiece, automatic alignment can be performed in combination with the Y-axis table. ($\theta 1$ -axis mounting plate <Option: **12AAE630**> is required when directly installing on the base of the **CS-3300**.)

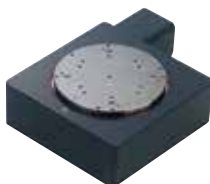

Rotation	360°
Resolution	0.004°
Maximum load	12 kg
Rotational speed	MAX 10°/s
Mass	7 kg



Rotary table $\theta 2$ -axis unit 178-078

You can measure multiple points on a cylindrical workpiece and automate front/rear-side measurement. ($\theta 2$ -axis mounting plate <Option: **12AAE718**> is required when directly installing on the base of the **CS-3300**.) To install on **3D-ALT**, a separate special plate for mounting the $\theta 2$ -axis unit (**12AAE707**) is required.



Rotation	360°
Resolution	0.0072°
Maximum load (loading moment)	4 kg (moment 343 N·cm or less)
Rotational speed	MAX 18°/s
Mass	5 kg



Centering chuck (ring operated) 211-032

This chuck is useful when measuring small workpieces. You can easily clamp them with its knurled ring.



Holding range	Inner jaws OD: $\phi 1$ to $\phi 36$ mm Inner jaws ID: $\phi 16$ to $\phi 69$ mm Outer jaws OD: $\phi 25$ to $\phi 79$ mm
Dimensions (DxH)	$\phi 118 \times 41$ mm
Mass	1.2 kg

Micro-chuck 211-031

This chuck is suitable for clamping extra-small diameter workpieces ($\phi 1$ mm or less), which cannot be retained with the centering chuck.



Holding range	OD: $\phi 0.2$ to $\phi 1.5$ mm
Dimensions (DxH)	$\phi 107 \times 48.5$ mm
Mass	0.6 kg

Auto leveling table 178-087

This table performs fully automatic leveling adjustment at the start of measurement. Full automation ensures rapid measurement regardless of the skill level of the operator.



Inclination adjustment angle	$\pm 2^\circ$
Maximum load	7 kg
Table dimensions	130x100 mm
Mass	3.5 kg



Optional Accessories for 3D Surface Roughness Measurement

Y-axis table for 3D measurement 178-096

The Y-axis table enables precise workpiece positioning during 3D surface roughness measurement. It delivers high-level 3D surface roughness analysis when used with **MCubeMap**, the 3D surface property analysis software.



Travel range	100 mm
Resolution	0.05 μm
Straightness (static)	0.3 $\mu\text{m}/100\text{ mm}$
Drive speed	0 to 20 mm/s
Maximum load	15 kg
Mass	31 kg

3D auto leveling table 3D-ALT 178-077

Installed on the Y-axis table for 3D measurement, this table performs fully automatic adjustment for precise leveling of measurement surfaces prior to the start of measurement. Operation is easy and reliable, allowing fully automatic leveling to be performed quickly by anyone.



Inclination adjustment angle	$\pm 2^\circ$ in XZ and YZ planes
Maximum load	10 kg
Stage surface size	139x139 mm
Mass	4.5 kg

3D surface property analyzing software MCubeMap

MCubeMap is 3D surface property analyzing software that visualizes the analyzed data clearly with a wide variety of graphic technologies. Being compliant with ISO 25178-2, the standard of 3D surface roughness parameters, it enables you to create impressive reports with graphics and flexible layout of analysis results.

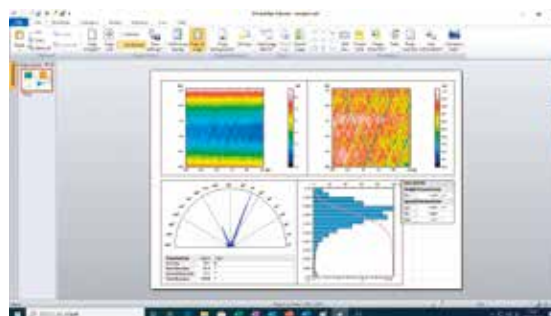
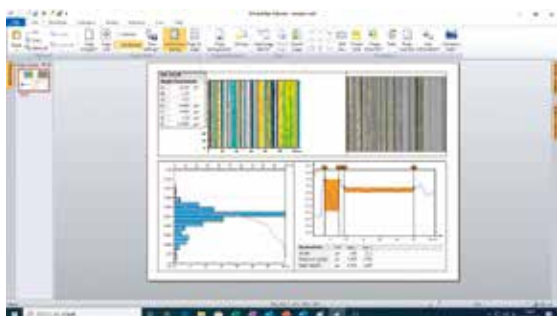

Optional Accessories

3-axis adjustment table 178-047

This table helps make the adjustments required when measuring the surface of cylindrical workpieces. The corrections for the pitch angle and the swivel angle are determined from a preliminary measurement and the Digimatic micrometers are adjusted accordingly. A flat-surfaced workpiece can also be leveled with this table. By using Mitutoyo's 3-axis adjustment table, the workpiece can be aligned and leveled easily, simply by following the **FORMTRACEPAK** guidance. No experience or special expertise is required.



Inclination adjustment angle	±1.5°
Swiveling angle	±2°
Y-axis travel range	±12.5 mm
Resolution	0.001 mm
Table dimensions	130x100 mm
Maximum load	15 kg

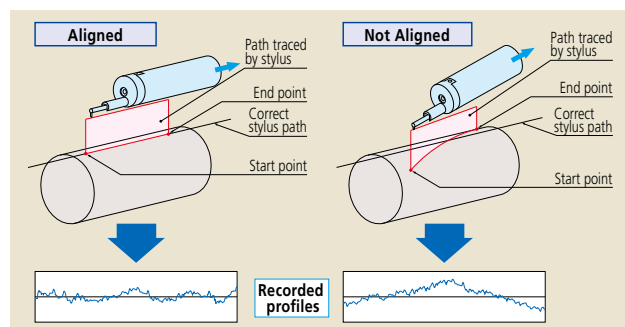
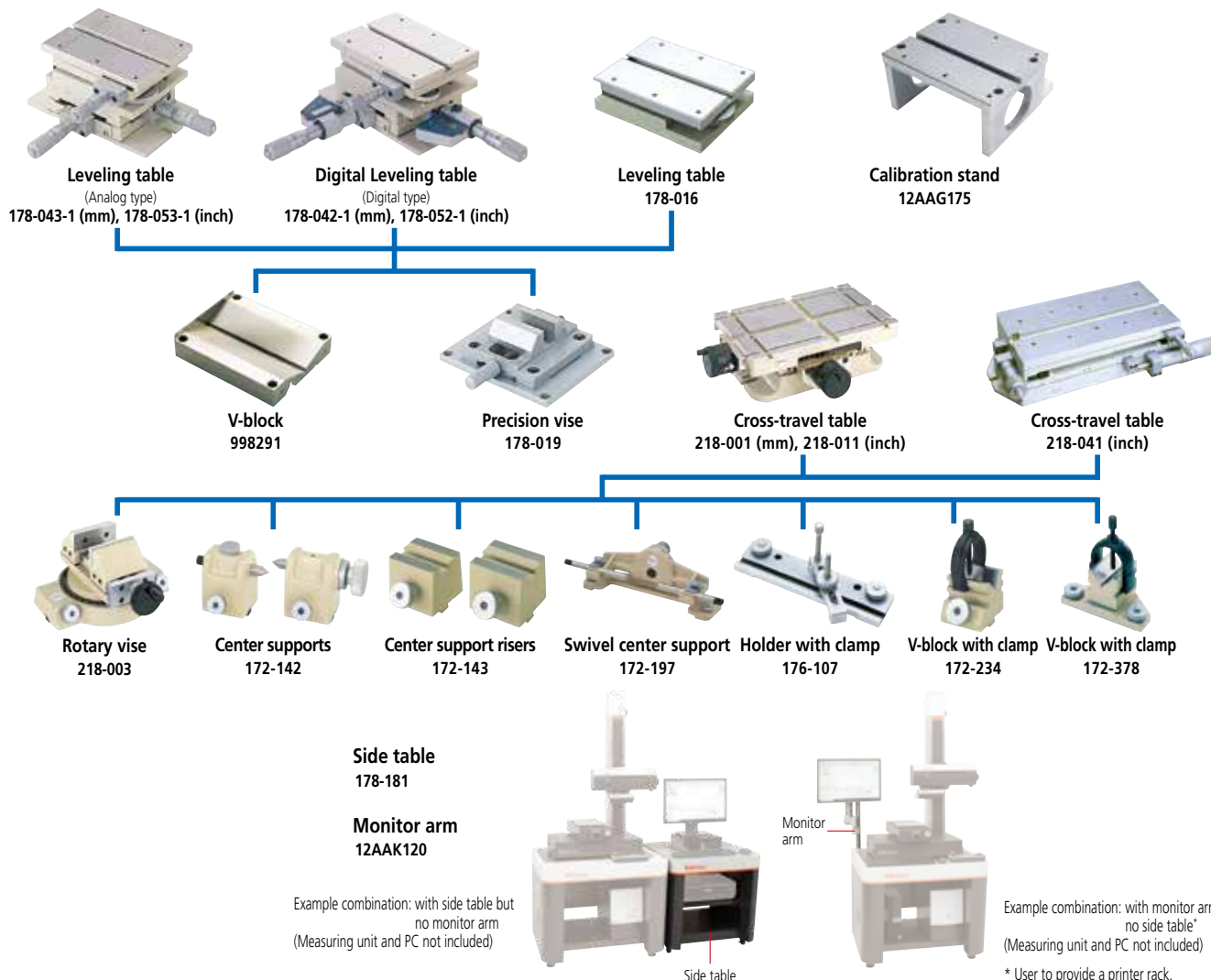

Table and fixture systems



Styli

Type	Dimensions	Unit: mm	Specifications
Standard stylus (12AAD554) Standard accessory			Tip radius: 2 μ m Tip form: 60° cone Tip material: Diamond For contour/surface roughness measurement Measurable depth: 7 mm MAX
Cone stylus (12AAD552) Standard accessory			Tip radius: 25 μ m Tip form: 30° cone Tip material: Sapphire For contour measurement Measurable depth: 7 mm MAX
Small hole stylus (12AAD556)			Tip radius: 2 μ m Tip form: 60° cone Tip material: Diamond For contour/surface roughness measurement Applicable hole: \varnothing 2 mm MIN Measurable depth: 15 mm MAX
Eccentric type stylus (12AAD558)			Tip radius: 2 μ m Tip form: 60° cone Tip material: Diamond For contour/surface roughness measurement Offset from center line: 15 mm MAX
Deep groove stylus (12AAD560)			Tip radius: 2 μ m Tip form: 60° cone Tip material: Diamond For contour/surface roughness measurement Measurable depth: 20 mm MAX
2x-long stylus*1 (12AAD562)			Tip radius: 5 μ m Tip form: 40° cone Tip material: Diamond For contour/surface roughness measurement MAX measuring range of Z axis is double (10 mm) that of the standard stylus.

*1: Measuring force is 4 mN and the Z-axis resolution is double that of the standard stylus.

Specifications

Model No.		CS-3300S4	CS-3300H4	CS-3300W4	CS-3300L4	CS-3300S8	CS-3300H8	CS-3300W8	CS-3300L8	
Measuring range	X axis	100 mm				200 mm				
	Z1 axis (detector)	5 mm (± 2.5 mm from the horizontal)								
Scale unit	X axis	Ultra-high precision linear encoder								
	Z1 axis (detector) Z2 axis (column)	Differential inductance ABS linear encoder								
Resolution	X axis	0.05 μ m								
	Z1 axis (detector)	0.08 μ m/5 mm 0.008 μ m/0.5 mm 0.0008 μ m/0.05 mm								
	Z2 axis (column)	1 μ m								
X-axis Tilting angle		$\pm 45^\circ$								
Z2-axis (column) travel range		300 mm	500 mm	700 mm	300 mm	500 mm	700 mm			
Drive speed	X axis	Software: 0 to 80 mm/s Remote box operation: 0 to 40 mm/s								
	Z2 axis (column)	Software: 0 to 30 mm/s Remote box operation: 0 to 30 mm/s								
Measuring speed	Surface roughness measurement	0.02, 0.05, 0.1, 0.2 mm/s								
	Contour measurement	0.02, 0.05, 0.1, 0.2, 0.5, 1.0, 2.0, 5.0, 10, 20, 30 mm/s * Recommended that measurements be conducted at measurement speeds no faster than 5 mm/s. (If the measurement speed is too fast, coupled with high surface roughness, this may cause the stylus to chip or compromise measurement accuracy.)								
Straightness (when the X axis is horizontal)		In the ordinary state: 0.2 μ m/100 mm Detector unit in its maximum state of protrusion: 0.4 μ m/100 mm				In the ordinary state: 0.6 μ m/200 mm Detector unit in its maximum state of protrusion: 1.2 μ m/200 mm				
Accuracy (20 °C)	X axis	$\pm (0.8+0.01L)$ μ m L: Measurement length (mm) Wide range: 1.8 μ m/100 mm Narrow range: 1.05 μ m/25 mm				$\pm (0.8+0.015L)$ μ m L: Measurement length (mm) Wide range: 3.8 μ m/200 mm Narrow range: 1.2 μ m/25 mm				
	Z1 axis (detector)	$\pm (1.5+2H/100)$ μ m H: Height measured from the horizontal (mm)								
Stylus vertical motion		Circular motion								
Measuring direction		Both pulling and pushing directions								
Measuring face direction		Downward								
Measuring force		0.75 mN								
Tracing angle (Standard accessory Cone stylus)		Ascent 65°, descent 65° (depending on the surface roughness)								
Stylus tip	Standard stylus	Stylus Tip radius: 2 μ m, angle: 60° Material: Diamond (for surface roughness/contour)								
	Cone stylus	Stylus Tip radius: 25 μ m, angle: 30° Material: Sapphire (for contour)								
Base size (WxD)		600x450 mm		1000x450 mm		600x450 mm		1000x450 mm		
Base material		Gabbro								
External dimensions	Measuring Unit	W	759 mm	759 mm	1159 mm	1159 mm	769 mm	769 mm	1169 mm	1169 mm
		D	482 mm	482 mm	482 mm	492 mm	482 mm	482 mm	482 mm	492 mm
		H	966 mm	1166 mm	1176 mm	1430 mm	966 mm	1166 mm	1176 mm	1430 mm
	Controller (WxDxH)	221x346x472 mm								
Remote box (WxDxH)		248x102x62 mm								
Mass	Measuring Unit	140 kg	150 kg	220 kg	270 kg	140 kg	150 kg	220 kg	270 kg	
	Controller	14 kg								
	Remote box	0.9 kg								
Vibration Isolating Stand	Anti-vibration mechanism	Diaphragm air suspension								
	Supply air pressure	0.4 to 0.7 MPa								
	Allowable load	250 kg		350 kg		250 kg		350 kg		
	External dimensions (WxDxH)	830x800x700 mm		1280x940x700 mm		830x800x700 mm		1280x940x700 mm		
Mass		155 kg		240 kg		155 kg		240 kg		
Accuracy guaranteed temperature range		20 °C \pm 1 °C								
Accuracy guaranteed temperature change over time (MAX)		2.0 °C/8 h								
Operating temperature range		5 to 40 °C (within ± 1 °C temperature fluctuation on calibration and measurement)								
Operating humidity range		RH 20 to 80 % (non-condensing)								
Storage temperature range		-10 to 50 °C								
Storage humidity range		RH 5 to 90 % (non-condensing)								
Communication interface		USB								
Power supply rating		100 to 120 V, 200 to 240 V ± 10 %, AC50/60 Hz								
Consumption		400 W								

Note: While the appearance of the natural stone measuring table varies according to the source, the high stability for which this material is known can always be relied upon.

Main Unit Startup System: Contour and Surface Roughness Measuring System introduced in this catalog incorporate a startup system (relocation detection system), which disables operation when an unexpected vibration is applied or the machine is relocated. Be sure to contact your nearest Mitutoyo sales office prior to relocating this machine after initial installation.

Dimensions

CS-3300S4/H4/W4/L4

Unit: mm

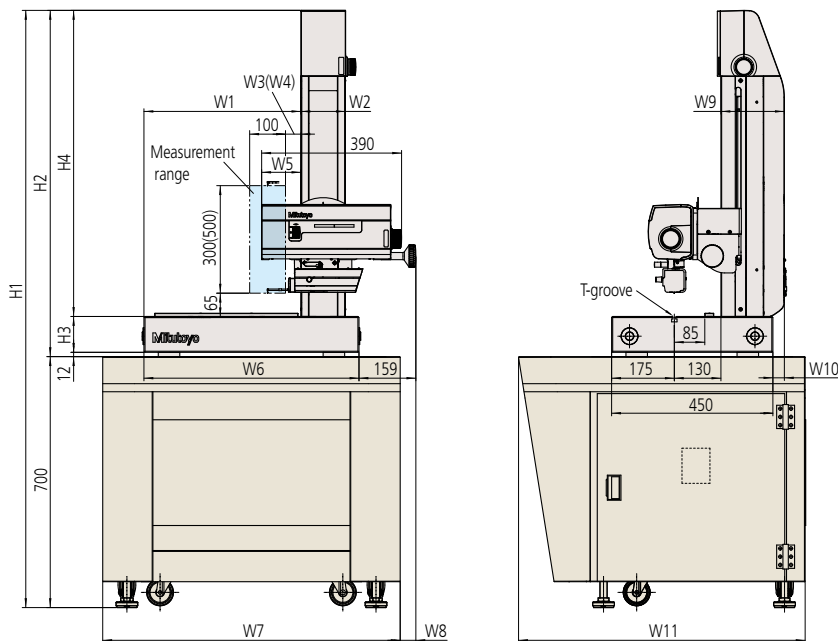

CS-3300S8/H8/W8/L8

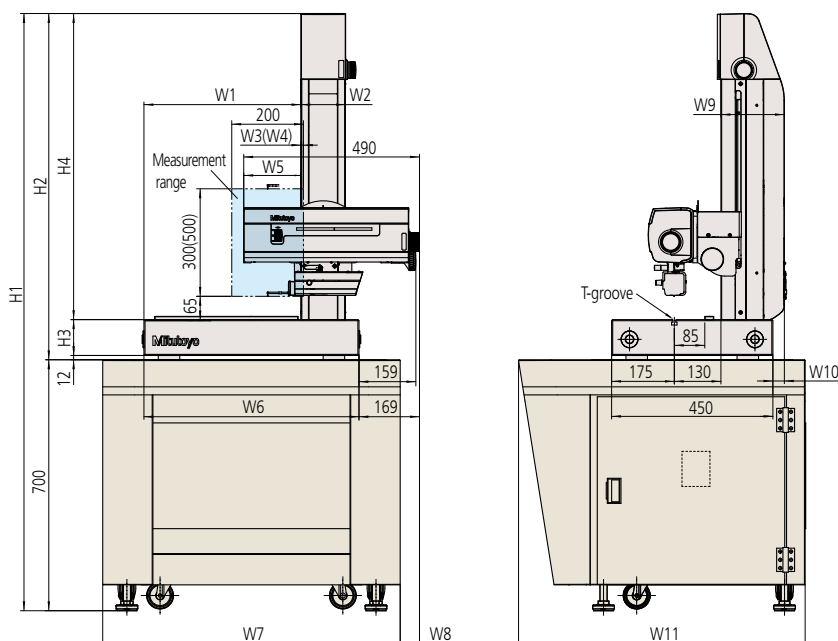

Unit: mm

X axis (drive unit)	Model No.	W1	W2	W3	W4*	W5	W6	W7	W8	W9	W10	W11	H1	H2	H3	H4
100 mm	CS-3300S4	438	124	43	113	110	600	830	44	177	32	800	1666	966	100	854
	CS-3300H4	438	124	43	113	110	600	830	44	177	32	800	1866	1166	100	1054
	CS-3300W4	838	124	43	113	110	1000	1280	19	177	32	940	1876	1176	110	1054
	CS-3300L4	825	150	30	100	97	1000	1280	19	187	42	940	2130	1430	110	1308
200 mm	CS-3300S8	438	124	-7	63	160	600	830	54	177	32	800	1666	966	100	854
	CS-3300H8	438	124	-7	63	160	600	830	54	177	32	800	1866	1166	100	1054
	CS-3300W8	838	124	-7	63	160	1000	1280	29	177	32	940	1876	1176	110	1054
	CS-3300L8	838	150	-20	50	147	1000	1280	29	187	42	940	2130	1430	110	1308

* W4: At maximum detector extension



Whatever your challenges are, Mitutoyo supports you from start to finish.

Mitutoyo is not only a manufacturer of top quality measuring products but one that also offers qualified support for the lifetime of the equipment, backed up by comprehensive services that ensure your staff can make the very best use of the investment.

Apart from the basics of calibration and repair, Mitutoyo offers product and metrology training, as well as IT support for the sophisticated software used in modern measuring technology. We can also design, build, test and deliver bespoke measuring solutions and even, if deemed cost-effective, take your critical measurement challenges in-house on a sub-contract basis.



Find additional product literature and our product catalogue

<https://www.mitutoyo.co.jp/global.html>

Our products are classified as regulated items under Japanese Foreign Exchange and Foreign Trade Law. Please consult us in advance if you wish to export our products to any other country. If the purchased product is exported, even though it is not a regulated item (Catch-All controls item), the customer service available for that product may be affected. If you have any questions, please consult your local Mitutoyo sales office.

Note: Product illustrations are without obligation. Product descriptions, in particular any and all technical specifications, are only binding when explicitly agreed upon. MITUTOYO and MICAT are either registered trademarks or trademarks of Mitutoyo Corp. in Japan and/or other countries/regions. Other product, company and brand names mentioned herein are for identification purposes only and may be the trademarks of their respective holders.

Mitutoyo

Mitutoyo Corporation

20-1, Sakado 1-Chome,
Takatsu-ku, Kawasaki-shi,
Kanagawa 213-8533, Japan
T +81 (0) 44 813-8230
F +81 (0) 44 813-8231
<https://www.mitutoyo.co.jp>