

Contour Measuring System CONTRACER CV-2100 Series

Remarkable operability and functionality revolutionize contour measuring systems and enable measurement that is fast, accurate, and easy.



After a thorough analysis of all contour measurement operations, key operating functions are redesigned to enable fast, accurate and easy measurements.





Key operation buttons are now mounted onto the X-axis drive unit to reduce set-up time and improve high-volume repetitive measurement processes.

Easy operation with X-axis jog shuttle

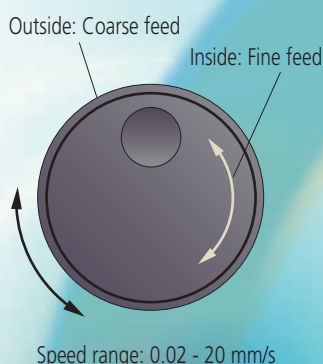

A jog shuttle covering a wide range of speed is a standard feature. The drive unit can be moved easily to the measurement position by using the jog shuttle.

Centralized front control panel



The operation flow is significantly shortened by arranging the switches for stylus position change, measurement start/stop and return on the front of the drive unit. These operations are required for every single measurement cycle. This centralized panel can therefore reduce the workload of operators and improve measurement efficiency.

A quick-vertical-motion stand with remarkable operability

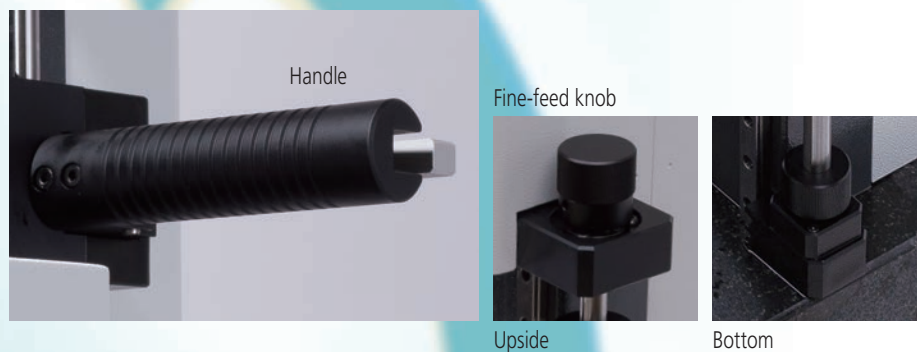

The newly designed stand allows operators to quickly and easily move the drive unit to and from the measurement height without having to push or pull.

Moreover, this stand is equipped with a reference stop for quick repositioning to the measurement height, which ensures an easy and highly efficient measurement flow.

Highly efficient measurement



By enabling faster X-axis movement and enhancing the stylus up/down functions, the drive unit can return to the measurement start position after auto-displacement of the stylus. This is especially useful when high volume repetitive measurements are being executed by a part program.

The combination of high accuracy and excellent operability allows for increased support of a wide range of measurement needs.

**"Pursuing high accuracy is our mission"
Introducing a new highly accurate digital scale**

The detector unit (Z1 axis) is equipped with a highly accurate arc scale. This scale directly tracks the arc locus of the stylus tip so that the most accurate compensation can be applied to the scale output, which leads to higher accuracy and resolution.

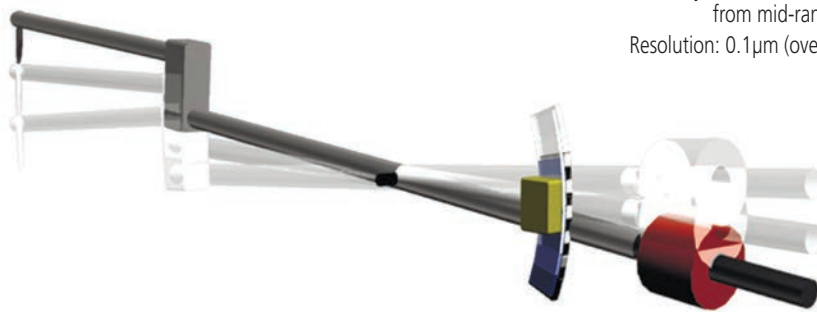

Measurement range of detector: 50mm
 Accuracy: $\pm(2.5+0.1H) \mu\text{m}$, where H is displacement from mid-range position (mm)
 Resolution: $0.1 \mu\text{m}$ (over entire measurement range)

Easy setup for highly accurate and efficient measurement

The highly accurate digital arc scale not only improves measurement accuracy, but can also be set up easily.

Operators are free from bothersome operations such as measurement magnification switching and calibrating each magnification as required for analog instruments.

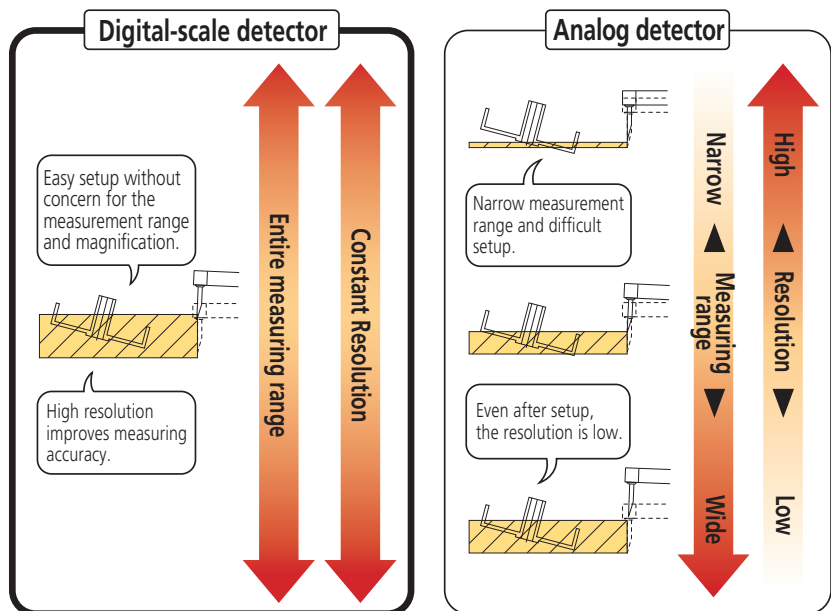

X-axis inclination handle is a standard feature

The CV-2100 series* is equipped with a drive unit inclination mechanism that enables inclined-plane measurement without changing settings.



* For **CV-2100N4**, a manual column stand **No.218-042** (refer to P13) is required (optionally available.)

Inclination angle (MAX): $\pm 45^\circ$
(For **CV-2100M4**)

A range of options available according to the application

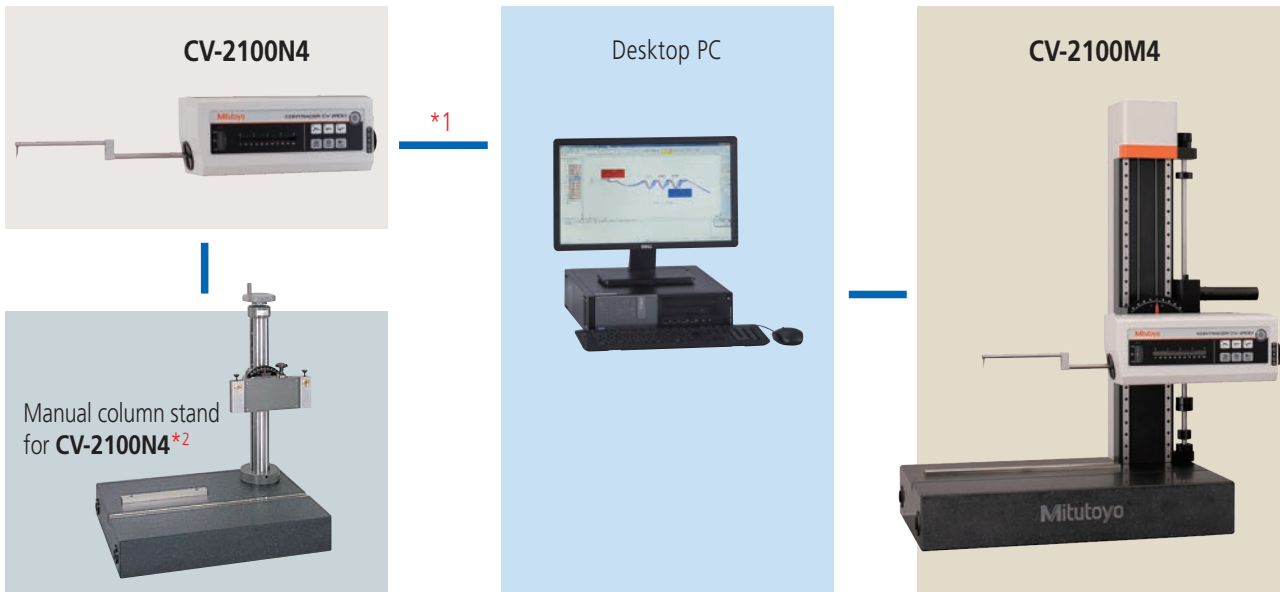

*1: If the **CV-2100N4** is operated without the dedicated manual stand, the measuring range of the Z axis might be reduced, depending on the installation conditions. If you are considering using the **CV-2100N4** without the stand, contact your local Mitutoyo sales office for advice.

*2: Optional accessory (refer to page 13).

Contour Analysis Software: FORMTRACEPAK

FORMTRACEPAK functions offer total support for measurement system control, surface roughness analysis, contour analysis, contour tolerancing, and inspection report creation.

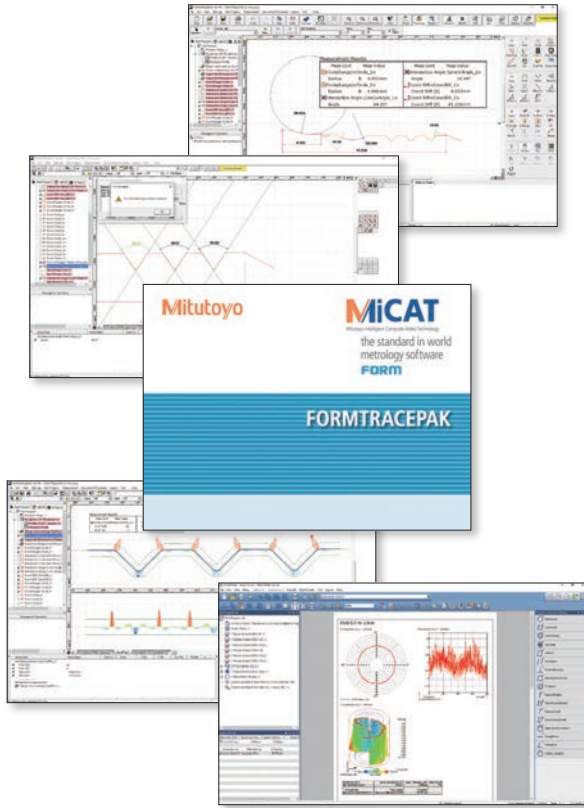

Measurement control

To make only a single measurement, you can create a part program in the single mode. To measure multiple workpieces of an identical shape, you can use the teaching mode. Since you can embed the entire flow, from making measurement to printing a report, into a part program, you can efficiently make measurements, analyze data, and output a report. A function is also provided that enables you to insert comments accompanied with photographs at desired timings, enabling you to embed the roles described in a measurement procedure document that specifies important points such as work settings.

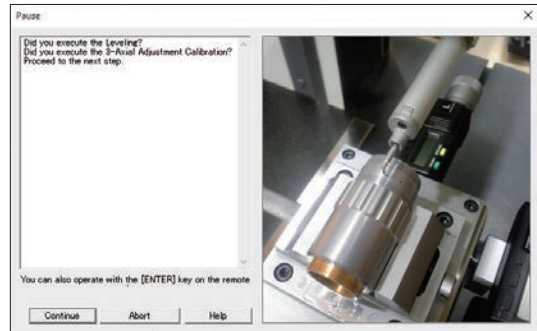

To make immediate measurements, you can use the pull-down menu to easily select and call up the desired operating procedure.

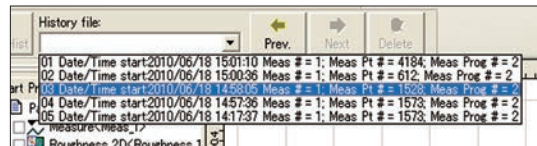

Multiple language support (18 languages)

You can switch the language* to be used in the measurement, analysis, and layout windows. After measurements have been made, you can switch to another language and create a report in that language. This function can be used worldwide.

* Supported languages: Japanese, English, German, French, Italian, Spanish, Polish, Hungarian, Swedish, Czech, Simplified Chinese, Traditional Chinese, Korean, Turkish, Portuguese, Dutch, Russian and Thai.

Button-editing function

You can hide buttons that are not used frequently. For example, you can choose to display only those buttons that are used frequently and increase the size of the displayed graphics window, thereby customizing the window to suit your needs.

Online help function*

Online help that can be viewed any time is incorporated into the software. In addition to index and keyword searches, a status saving help button, which displays menus and Windows help with a click of the mouse, is provided.

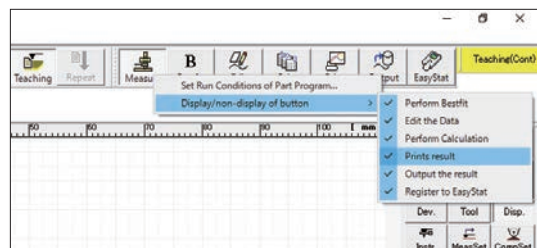
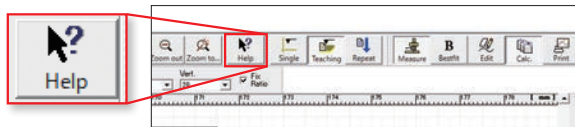

* Online help function supports only Japanese and English.

Contour Analysis

Contour analysis function

A wide variety of commands, which form the basic elements for analysis, are provided, including those for points (10 kinds), lines (6 kinds), and circles (6 kinds). A rich set of commands that combine these elements to calculate angles, pitches, and distances, a contour tolerancing function, and a design value generation function are also provided as standard features. These functions, combined with the function that allows you to customize the calculation command buttons by hiding less frequently used commands, let you tailor the window according to the user environment.

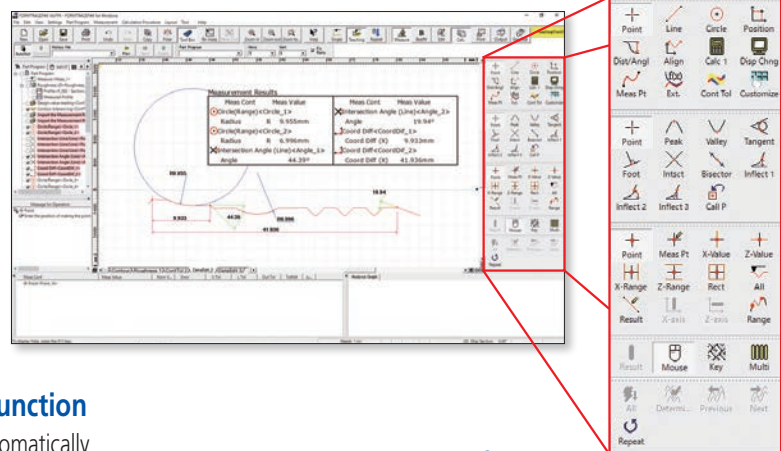

Circle and line automatic determination function

Using the circle/line auto-fitting command, you can automatically calculate all circles and lines contained in the data without having to click the command button each time.

Removal of abnormal points function

Irregular defects in the data are filtered out from the calculation. This function can be effective when specifying the calculation range for locations at which the boundary between circle and line is difficult to determine.

Text output of the calculation result and graphics data

You can output the calculation result as text (in csv or txt format), output graphics data obtained from measurements as point-string data to a text file or CAD file (in the DXF or IGES format), or copy the data to the clipboard. Combined with commercial document or statistical processing software, this feature can be used to share data with computers that do not have dedicated analysis software installed or execute CAD-based reverse engineering.

Simple pitch calculation function

You can efficiently analyze the pitch between identical shapes, such as a screw pitch or the distance between circles (center-to-center pitch), by simply specifying the desired range using mouse operations.

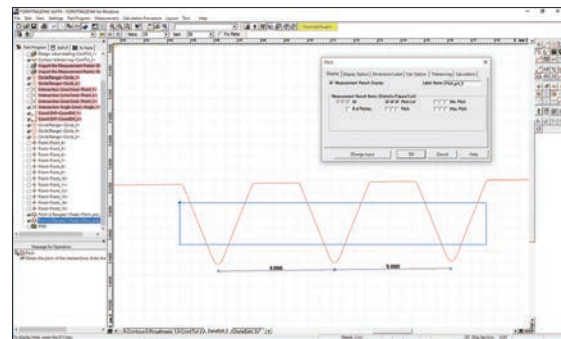

Example of range specification for screw thread pitch with rectangular tool.

Contour-tolerancing function as a standard feature

The best-fit processing function that moves the coordinate values of the design data and measurement data to the optimum positions is provided as a standard feature. Measurement results can be displayed as graphics that show deviations of the measured contour from nominal with the tolerance values expanded in each coordinate for easy comparison. Results can also be output as a text file, or utilized as feedback data for machining systems.

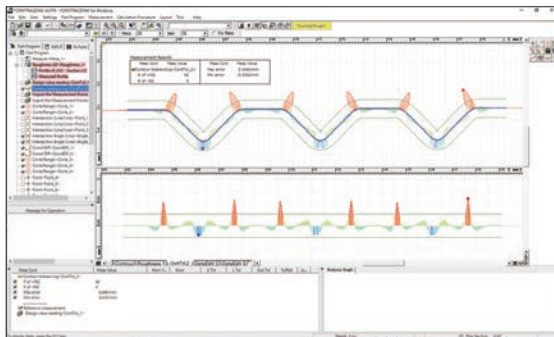

Example of contour-tolerancing result in graphical form

| Coord | Meas Value | Design Value | Tolerance |
|-------|------------|--------------|-----------|
| 1 | 10.0000 | 10.0000 | ±0.0050 |
| 2 | 10.0000 | 10.0000 | ±0.0050 |
| 3 | 10.0000 | 10.0000 | ±0.0050 |
| 4 | 10.0000 | 10.0000 | ±0.0050 |
| 5 | 10.0000 | 10.0000 | ±0.0050 |
| 6 | 10.0000 | 10.0000 | ±0.0050 |
| 7 | 10.0000 | 10.0000 | ±0.0050 |
| 8 | 10.0000 | 10.0000 | ±0.0050 |
| 9 | 10.0000 | 10.0000 | ±0.0050 |
| 10 | 10.0000 | 10.0000 | ±0.0050 |

Example of contour-tolerancing results output as numeric values

Contour Analysis Software: FORMTRACEPAK

Contour Analysis

Design value generation function

You can generate design data from CAD data (DXF or IGES file) or text data. Furthermore, since you can also convert measurement data into design data, you can save parts data prior to use (testing) as design data and effectively utilize it for checking the wear following use (testing).

Data combination function

You can combine partial data collected separately from a workpiece (made necessary due to shape characteristics) into a single graphic for convenient analysis.

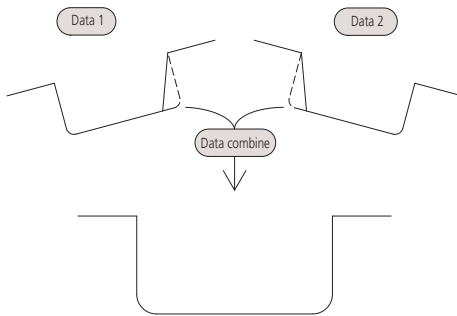

Calculation command repetition setting

When identical shapes have the same pitch, you can analyze all of the shapes in a batch by specifying a single analysis location and the pitch.

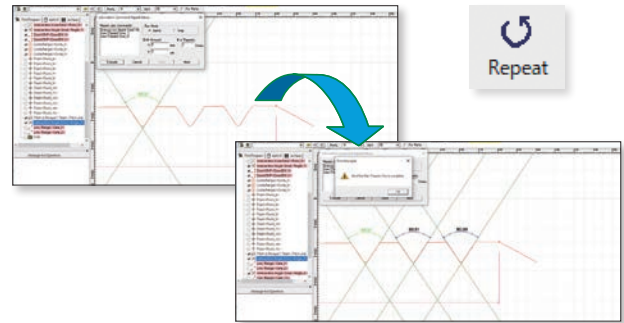

Best-fit processing function for measurement point strings

This function tries to fit the measurement points to the stored reference data on the same coordinate system. It can eliminate the effects of a shift that may occur when setting the workpiece during automatic analysis.

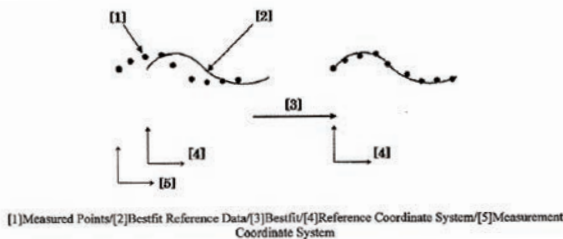

Data superimposition command

You can superimpose two sets of data by detecting their characteristic points. Use the mouse to drag and move the measurement point strings to the desired positions to be superimposed.

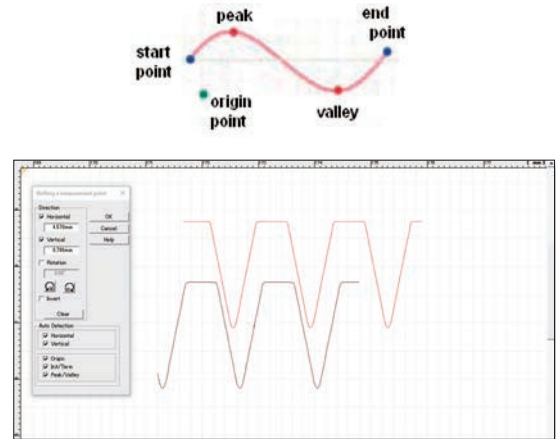

Integrated layout

You can use simple operations to lay out graphics obtained from measurements as well as measurement results for surface roughness, contour, and roundness on a single page.

Furthermore, since the program now allows you to specify a saved file and paste it, you can easily paste results from multiple files.

Note: The optional ROUNDPAK roundness/cylindricity analysis program is required.
For adaptable version, please contact your local Mitutoyo sales office.

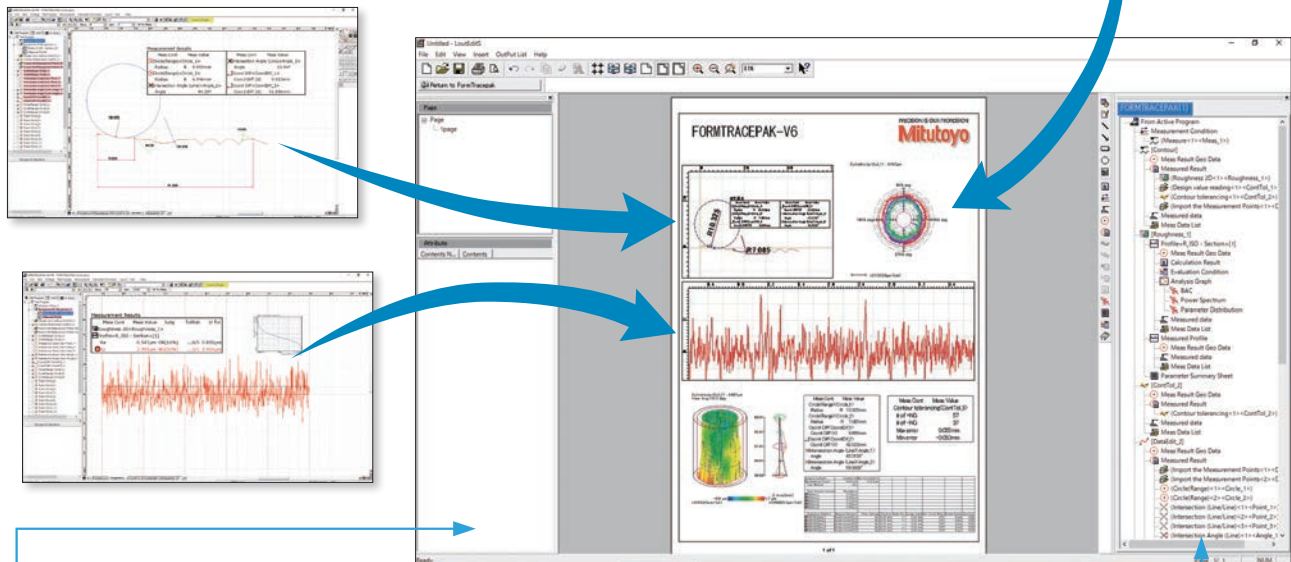
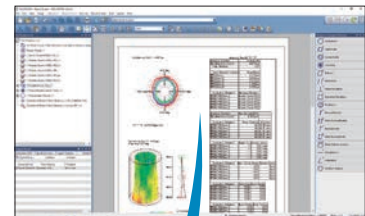

Element information bar

This bar displays the attribute values of the pasted items, allowing you to easily check the contents of the pasted measurement data files.

System layout printing

By simply selecting the items to be output, you can automatically lay out the page to be printed.

Use this feature when you wish to simplify the printing task.

Element insertion bar

Using the mouse to drag and drop the analysis content displayed in the element insertion bar, you can paste it into the layout. From the contour analysis result, you can also select the analysis result for a circle or line alone and paste it in position.

Saving the result as a web page

Since you can save the result in html or mhtml format, which can be displayed using Internet Explorer or Microsoft Word, you can check the result even on a PC on which no layout-editing program is installed.

Optional Accessories

3-axis Adjustment Table: 178-047

This table helps make the adjustments required when measuring cylindrical surfaces. The corrections for the pitch angle and the swivel angle are determined from a preliminary measurement and the Digimatic micrometers are adjusted accordingly. A flat-surfaced workpiece can also be leveled with this table. By using Mitutoyo's 3-axis adjustment table, the workpiece can be aligned and leveled easily, simply by following the FORMTRACEPAK guidance. No experience or special expertise is required.



Guidance display when using 3-axis adjustment table

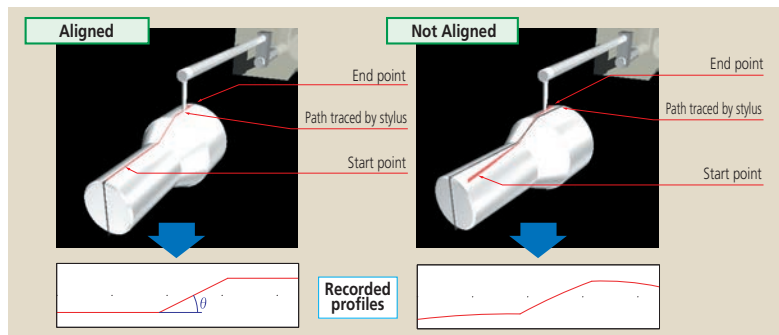
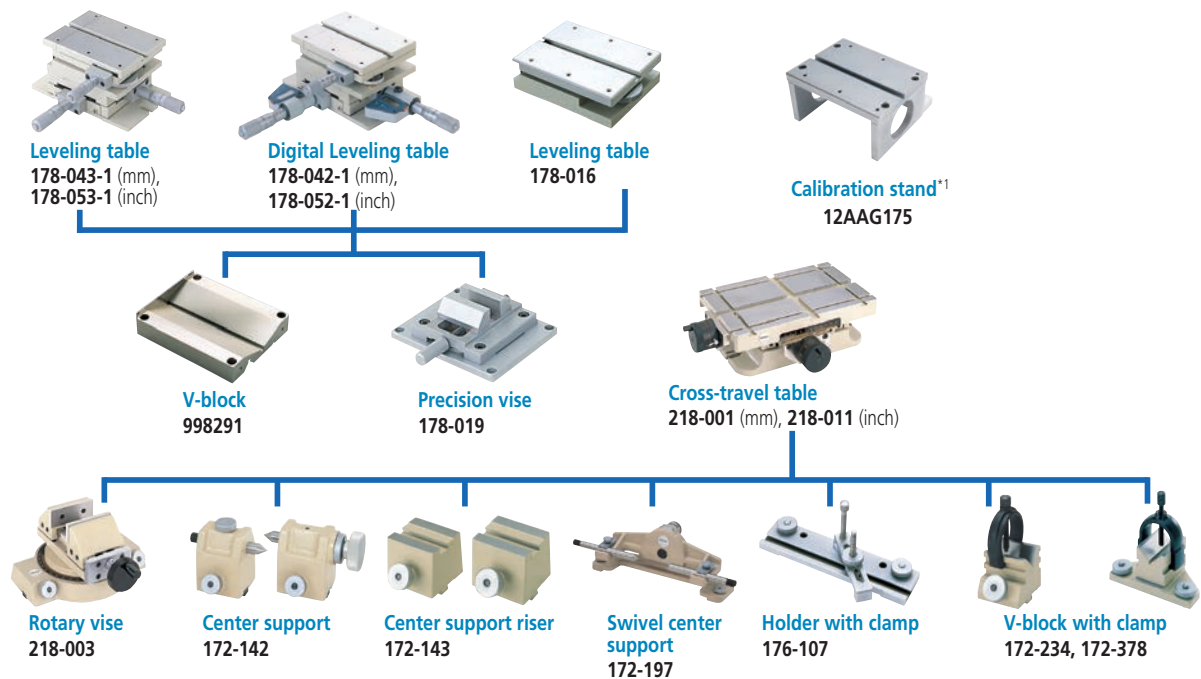

Table and fixture systems



*1 Required for calibrating in bulk by mounting straight arm/small-hole stylus arm without using cross-travel table and Y-axis table.

Optional Accessories

Manual column stand for CV-2100N4

218-042 Does not include (CV-2100N4)
 Vertical adjustment range: 12.6" (320mm)
 Inclination angle (MAX): ±45°
 Dimensions (WxDxH) : 23.6"x17.7"x29.1" (600x450x740mm)
 Mass: 242 lbs (110 kg)

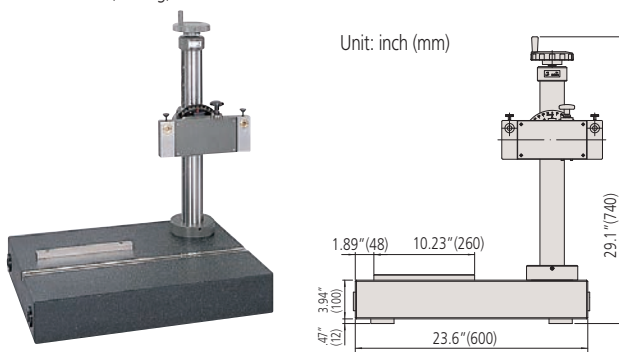

* Quick-vertical-motion function is not available

Vibration isolators (Desktop types), floor stand and tables

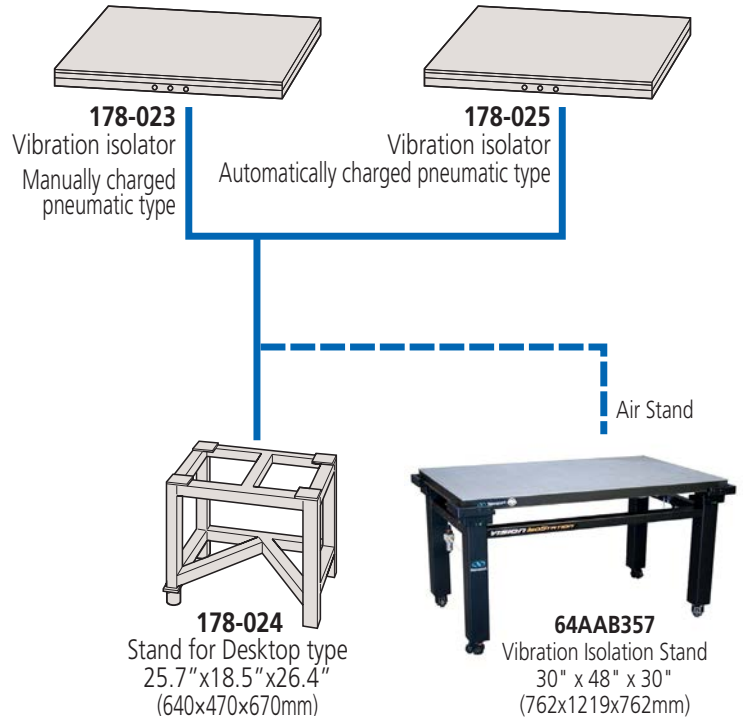

Vibration isolators (Desk types)

Desk types

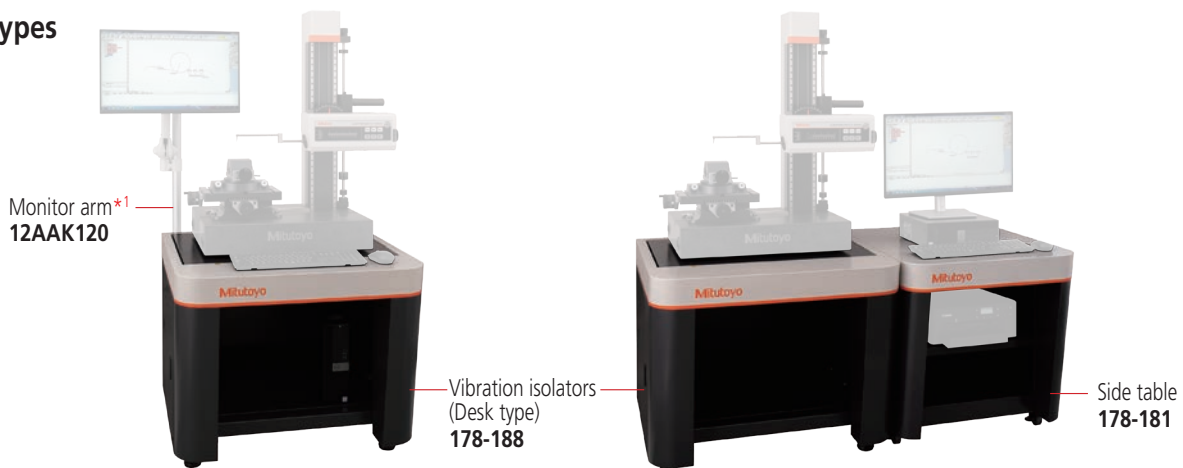

Example combination*2: with monitor arm but no side table*3

Example combination*2: with a side table but no monitor arm

*1 Used together with vibration isolator (178-188).
 *2 The vibration isolators does not include the measuring unit, controller, and analysis unit
 *3 User to provide a printer rack.

Arms and Stylus

Arms (option)

| Type of arm | Arm No. | Parts No. | Adaptation stylus No. | h (mm) |
|----------------|---------|-----------|-----------------------------|--------|
| Straight arm | AB-51 | 935111 | SPH-51,52,53,54,55,56,57 | 6 |
| | AB-61 | 935112 | SPH-61,62,63,64,65,66,67 | 12 |
| | AB-71* | 935113 | SPH-71,72,73,74,75,76,77,79 | 20 |
| | AB-81 | 935114 | SPH-81,82,83,84,85,86,87 | 30 |
| | AB-91 | 935115 | SPH-91,92,93,94,95,96,97 | 42 |
| Eccentric arm | AB-52 | 935116 | SPH-51,52,53,54,55,56,57 | 6 |
| | AB-62 | 935117 | SPH-61,62,63,64,65,66,67 | 12 |
| | AB-72 | 935118 | SPH-71,72,73,74,75,76,77,79 | 20 |
| | AB-82 | 935119 | SPH-81,82,83,84,85,86,87 | 30 |
| Small-hole arm | AB-11 | 935110 | SP-11,31 | 0.4 |
| | | | SP-12,32 | 1 |
| | | | SP-13,33 | 2.5 |

*Standard accessory

* Select an arm and stylus that match the type of measurement you require.

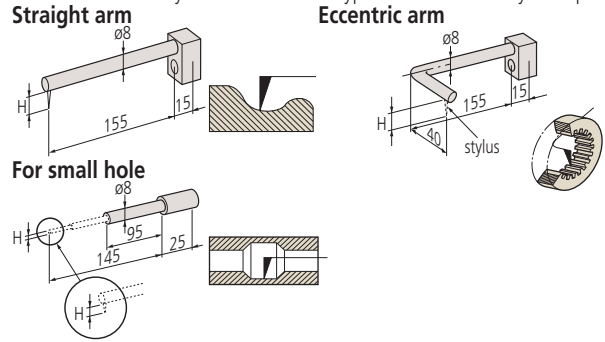

Styli (option)

| Type of stylus | Stylus No. | Parts No. | Adaptation arm No. | h (mm) |
|--|------------|-----------|--------------------|--------|
| One-sided cut stylus | SPH-51 | 354882 | AB-51-52 | 6 |
| | SPH-61 | 354883 | AB-61-62 | 12 |
| | SPH-71* | 354884 | AB-71-72 | 20 |
| | SPH-81 | 345885 | AB-81-82 | 30 |
| | SPH-91 | 354886 | AB-91-92 | 42 |
| Intersecting cut stylus | SPH-52 | 354887 | AB-51-52 | 6 |
| | SPH-62 | 354888 | AB-61-62 | 12 |
| | SPH-72 | 354889 | AB-71-72 | 20 |
| | SPH-82 | 354890 | AB-81-82 | 30 |
| | SPH-92 | 354891 | AB-91-92 | 42 |
| Cone stylus Tip angle 20° (Carbide) | SPH-57 | 12AAE865 | AB-51-52 | 6 |
| | SPH-67 | 12AAE866 | AB-61-62 | 12 |
| | SPH-77 | 12AAE867 | AB-71-72 | 20 |
| | SPH-87 | 12AAE868 | AB-81-82 | 30 |
| | SPH-97 | 12AAE869 | AB-91-92 | 42 |
| Cone stylus Tip angle 30° (Sapphire) | SPH-53 | 354892 | AB-51-52 | 6 |
| | SPH-63 | 354893 | AB-61-62 | 12 |
| | SPH-73 | 354894 | AB-71-72 | 20 |
| | SPH-83 | 354895 | AB-81-82 | 30 |
| Cone stylus Tip angle 50° (diamond) | SPH-79 | 355129 | AB-71-72 | 20 |
| Cone stylus Tip angle 30° (Carbide) | SPH-56 | 12AAA566 | AB-51-52 | 6 |
| | SPH-66 | 12AAA567 | AB-61-62 | 12 |
| | SPH-76 | 12AAA568 | AB-71-72 | 20 |
| | SPH-86 | 12AAA569 | AB-81-82 | 30 |
| | SPH-96 | 12AAA570 | AB-91-92 | 42 |
| Knife-edge stylus | SPH-54 | 354897 | AB-51-52 | 6 |
| | SPH-64 | 354898 | AB-61-62 | 12 |
| | SPH-74 | 354899 | AB-71-72 | 20 |
| | SPH-84 | 354900 | AB-81-82 | 30 |
| | SPH-94 | 354901 | AB-91-92 | 42 |
| Ball stylus | SPH-55 | 354902 | AB-51-52 | 6 |
| | SPH-65 | 354903 | AB-61-62 | 12 |
| | SPH-75 | 354904 | AB-71-72 | 20 |
| | SPH-85 | 354905 | AB-81-82 | 30 |
| | SPH-95 | 354906 | AB-91-92 | 42 |
| Small-hole stylus (One-sided cut) | SP-11 | 932693 | AB-11 | 0.4 |
| | SP-12 | 932694 | AB-11 | 1 |
| | SP-13 | 932695 | AB-11 | 2.5 |
| Small-hole stylus (Cone) | SP-31 | 12AAE873 | AB-11 | 0.4 |
| | SP-32 | 12AAE874 | AB-11 | 1 |
| | SP-33 | 12AAE875 | AB-11 | 2.5 |

*Standard accessory

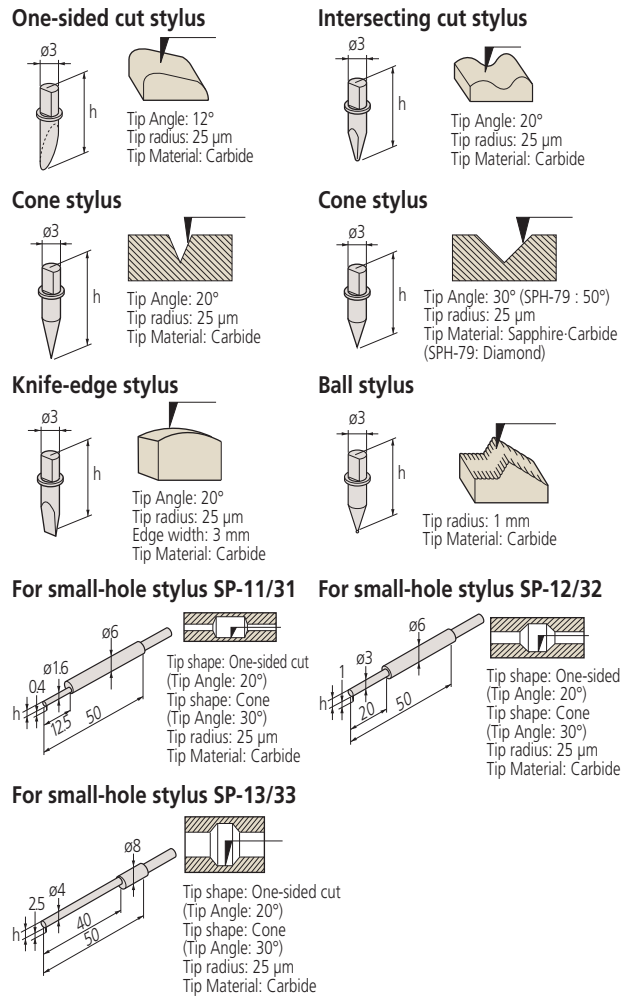

Specifications

Specifications

| Model | | CV-2100M4 | CV-2100N4 |
|--|-------------------------|---|-------------------------------------|
| Order No. | | 218-643-13 | 218-623-13 |
| Measurement range | X-axis | 4" (100mm) | |
| | Z1-axis (detector unit) | 2" (50mm) | |
| Z2-axis (column) travel range | | 13.8" (350mm) | — |
| X-axis inclination angle | | ±45° | — |
| Resolution | X-axis | 3.93µin (0.1µm) | |
| | Z1-axis | 3.93µin (0.1µm) | |
| Drive method | X-axis | Motorized drive 0 - 0.79in/s (0 - 20mm/s) | |
| | Z2-axis (column) | Manual (quick-up-and-down motion, fine feed) | — |
| Measuring speed | | 0.00078 - 0.2in/sec (0.02 - 5mm/s) | |
| Linearity accuracy (X-axis horizontal orientation) | | 98.4µin/4in (2.5µm/100mm) | |
| Accuracy (20°C) | X-axis | ±(98.4 + .79L) µin [±(2.5+0.02L) µm] L = Measurement Length (mm) | |
| | Z1-axis | ±(98.4+ 3.9H) µin [±(2.5+ 0.1H) µm] H = Measurement height from horizontal position within 1" (±25mm) | |
| Measurement direction | | Push and pull | |
| Measurement surface direction | | Downward | |
| Measuring force | | (3gf) (30±10mN) | |
| Stylus traceable angle (Standard accessory stylus) | | Ascent 77°, Descent 87° (Depends on the surface condition) | |
| External dimensions (WxDxH) | | 29.3"x17.7"x34.8" (745x450x885mm) | 23.7"x5.63"x5.45" (601x143x138.5mm) |
| Mass | | 321.43 lbs (145.8 kg) | 12.78 lbs (5.8 kg) |

Dimensions

CV-2100N4

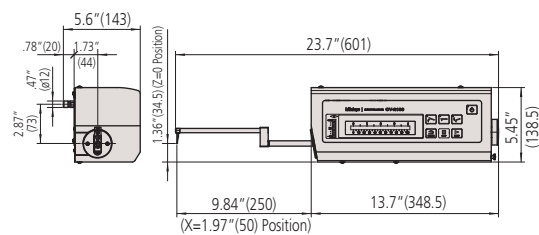

CV-2100M4

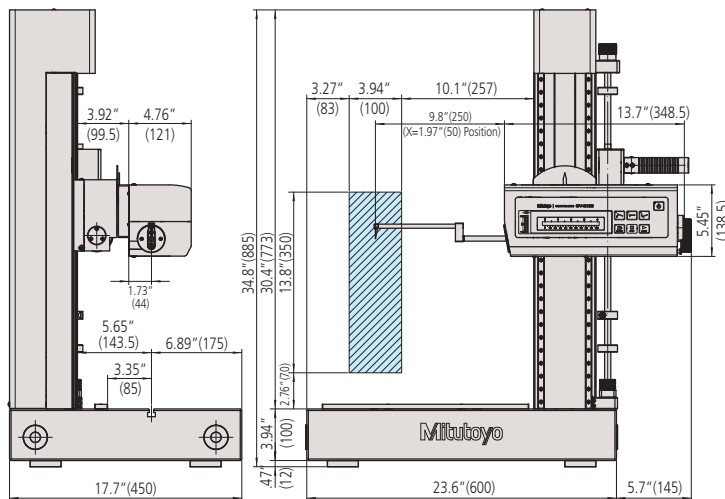

Unit: inch(mm)

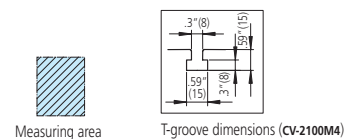

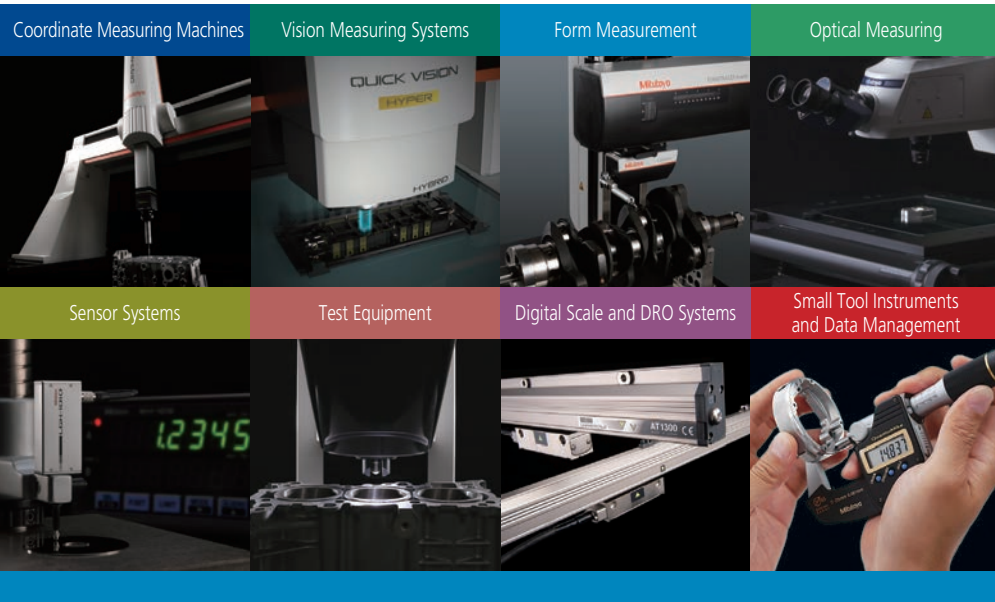

Whatever your challenges are, Mitutoyo supports you from start to finish.

Mitutoyo is not only a manufacturer of top quality measuring products but one that also offers qualified support for the lifetime of the equipment, backed by comprehensive services that ensure your staff can make the very best use of the investment.

Apart from the basics of calibration and repair, Mitutoyo offers product and metrology training, as well as IT support for the sophisticated software used in modern measuring technology. We can also design, build, test and deliver measuring solutions and even, if deemed cost-effective, take your critical measurement challenges in-house on a sub-contract basis.



Find additional product literature and our product catalog

www.mitutoyo.com

Note: All information regarding our products, and in particular the illustrations, drawings, dimensional and performance data contained in this printed matter as well as other technical data are to be regarded as approximate average values. We therefore reserve the right to make changes to the corresponding designs. The stated standards, similar technical regulations, descriptions and illustrations of the products were valid at the time of printing. In addition, the latest applicable version of our General Trading Conditions will apply. Only quotations submitted by ourselves may be regarded as definitive. Specifications are subject to change without notice.

Mitutoyo products are subject to US Export Administration Regulations (EAR). Re-export or relocation of our products may require prior approval by an appropriate governing authority.

Trademarks and Registrations

Designations used by companies to distinguish their products are often claimed as trademarks. In all instances where Mitutoyo America Corporation is aware of a claim, the product names appear in initial capital or all capital letters. The appropriate companies should be contacted for more complete trademark and registration information.



Mitutoyo America Corporation

www.mitutoyo.com
 One Number to Serve You Better
 1-888-MITUTOYO (1-888-648-8869)

M³ Solution Centers:

- Aurora, Illinois (Headquarters)
- Boston, Massachusetts
- Charlotte, North Carolina
- Cincinnati, Ohio
- Detroit, Michigan
- Los Angeles, California
- Seattle, Washington
- Houston, Texas