



DYNACRAFT®

OWNER'S MANUAL

6V QUAD

THIS MANUAL CONTAINS IMPORTANT SAFETY, PERFORMANCE AND MAINTENANCE INFORMATION. READ THE MANUAL BEFORE TAKING YOUR FIRST RIDE OR ALLOWING YOUR CHILD TO RIDE YOUR NEW ELECTRIC RIDE-ON TOY. KEEP THE MANUAL HANDY FOR FUTURE REFERENCE.

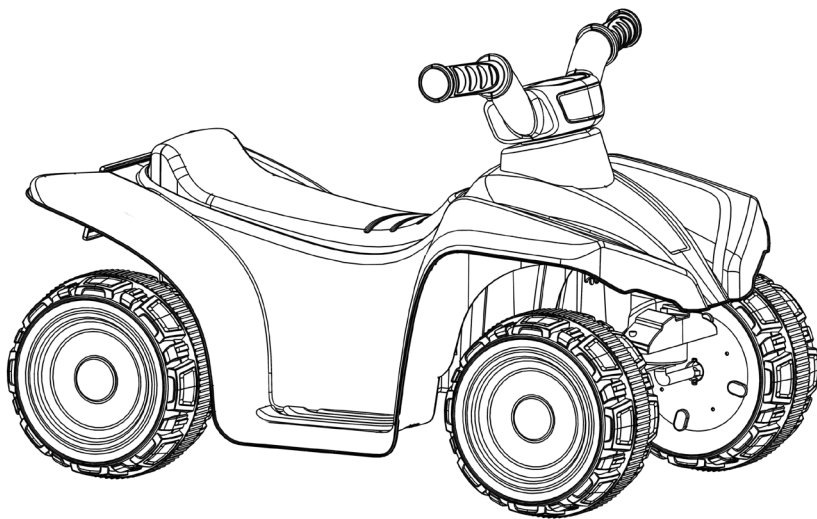

DO NOT RETURN THIS ITEM TO THE STORE
CONTACT DYNACRAFT CUSTOMER SERVICE FOR ASSISTANCE

dynacraftwheels.com/contact

or 1-800-551-0032 9 AM–5 PM ET



FOR AGES 18–36 MONTHS
MAXIMUM WEIGHT: 40 lb (18 kg)

NOTE: Illustrations in this Manual are for reference purposes only and may not reflect the exact appearance of the actual product. Specifications are subject to change without notice.

TABLE OF CONTENTS

A Introduction, Safety and Warnings	2
B Before You Begin Assembly	6
C Parts Diagram	7
D Assembly	8
E How to Use Your Ride-On Toy	11
F Detailed Maintenance and Repair	13
G Troubleshooting Guide	16
H Limited Warranty	21

SPECIFICATIONS

SUITABLE AGE	18-36 Months
CAPACITY.	Up to 40 lb (18 kg)
SPEED	2 MPH
CHARGER / INPUT.	AC120V/60HZ
OUTPUT.	DC 6V/0.5A
CHARGING TIME	12-18 Hours
BATTERY6V 4AH, 1x Battery
SIZE OF CAR	65 x 41 x 41 cm
AVERAGE BATTERY LIFE	300 Charges

INTRODUCTION, SAFETY AND WARNINGS

ABOUT THIS MANUAL: This Manual was written to help you and your child get the most performance, comfort, enjoyment and safety when riding your new electric ride-on toy. It is important for you to understand your new electric ride-on toy. By reading this manual before you let your child go out on his/her first ride, you will know how to get the most from your new electric ride-on toy. It is also important that you or your child's first ride be in a controlled environment, away from cars, obstacles, and other riders.

⚠ GENERAL WARNING: Riding an electric ride-on toy can be a dangerous activity, even under the best of circumstances. Proper maintenance of your new ride-on toy is your responsibility and helps reduce the risk of injury. Certain conditions may cause components to fail without fault of the manufacturer. The ride-on toy can and is intended to move, and it is therefore possible to lose control, fall off and/or get into dangerous situations that no amount of care, instruction or expertise can eliminate. If such a thing does occur, your child can become seriously injured or die, even when using safety equipment and other safety precautions.

⚠ WARNING: To reduce risk of injury, adult supervision is required. Never use in roadways, near motor vehicles, on or near steep inclines or steps, swimming pools or other bodies of water; always wear shoes, and never allow more than one (1) rider.

⚠ WARNING: Do not ride in rain, snow, or mud, or store the ride-on toy outside without covering. Water can damage components, including the motor, electrical system, and battery.

⚠ WARNING: This ride-on toy is not an off-road vehicle and is intended to be ridden on smooth, level ground. Do not ride in loose dirt, sand, or gravel, which could damage moving parts, the motor, or the electrical system.

NOTE: Store the ride-on toy indoors when not in use or in a covered location. Avoid long term exposure to rain, excessive sun, or other inclement weather.

RIDE AT YOUR OWN RISK AND ALWAYS USE COMMON SENSE. This manual contains many warnings and cautions concerning the consequences of failing to inspect, maintain or properly use your electric ride-on toy. Because any fall can result in serious injury or even death, we do not repeat the warning of possible serious injury or death each time such a possibility is mentioned in this manual or the risk of falling leads to a warning. **ALWAYS USE PROPER RIDING ATTIRE.** Always wear appropriate clothing and shoes. Never ride barefoot or in sandals and make sure that shoelaces or other fasteners are tied and kept away from the wheels and drive system of the ride-on toy.

RIDER USE AND REQUIRED PARENTAL SUPERVISION

RIDERS MUST NOT EXCEED THE WEIGHT LIMIT OF 40LB (18KG) AND MUST BE OVER 18 MONTHS OLD.

The age grade for the electric ride-on toy is for ages 18–36 months. Just because your child is within the age and weight limitations specified for the electric ride-on toy, does not mean that his/her size is appropriate to fit or maintain control of the electric ride-on toy, or that he/she is capable of safely operating the electric ride-on toy. You are the best judge of whether you or your child can safely operate the electric ride-on toy; this includes determining whether your child is at the appropriate developmental stage for safe use of the electric ride-on toy. Any rider that is unable to fit comfortably on the electric ride-on toy should never attempt to ride it. A parent's decision to allow their child to use the electric ride-on toy should be based on the child's maturity, skill and their ability to follow rules. Remember that the electric ride-on toy is intended for use only by children who are, at a minimum, able to comfortably and safely operate it.

Children operating the electric ride-on toy should be supervised by an adult at all times. Parents should ensure that children only use the electric ride-on toy safely and within their age and physical limits.

This manual contains very important safety information. It is your responsibility to completely review this information and make sure that all riders understand all of the warnings, cautions, instructions and safety topics addressed in this manual and to assure that all riders are able to safely and responsibly use the electric ride-on toy. You should periodically review and reinforce all information in this manual with all riders, especially children. You should also regularly inspect and maintain your electric ride-on toy to ensure the safety of all riders. Make sure that your new electric ride-on toy is properly fitted to any child riding it; that it is in good repair and safe operating condition; that you and your child have gone over the use, operation and safety information in this manual; that you and your child have learned and understand what to do and what not to do with your new electric ride-on toy, including observing all applicable laws, rules and common sense.

Children should be made aware of all possible riding hazards and correct riding behavior before they ride the electric ride-on toy and should be supervised by an adult at all times. Please explain the following to them as often as necessary.

SAFE RIDING PRACTICES AND WARNINGS

- Check and obey all local laws or regulations which may be in effect in the locations where the electric ride-on toy may be used.
- Always wear appropriate clothing and shoes.
- Observe the age and weight limitations on the cover of this manual.
- Always stay seated while riding the electric ride-on toy. To stop you must take your hand off the power button on the handlebar.
- Children must be supervised by an adult at all times to be safe.
- Always be alert and ride your electric ride-on toy defensively. Watch out for obstacles that could catch one of the electric ride-on toy's wheels or force you to turn suddenly and/or lose control. Be careful to avoid pedestrians, persons using other wheeled products (including roller or in-line skates, skateboards, scooters, bikes, etc.), children or animals who may enter your path. Always respect the rights and property of others.
- Do not activate the power button unless you are seated on the ride-on toy and in a safe environment that is suitable for riding your electric ride-on toy.
- Do not attempt or perform any stunts or tricks on the electric ride-on toy. It is not made to withstand such misuse and abuse.
- Keep both hands on the handlebar at all times.
- Do not touch the motor on the electric ride-on toy when in use or directly after use as these parts can become extremely hot.
- Never allow more than one person to ride the electric ride-on toy at one time and never try to tow anything.
- Do not use near steps, water, or swimming pools.
- Do not ride in wet weather.
- Never immerse the electric ride-on toy in water; electrical and drive components could be damaged by water or create other potentially unsafe conditions.
- Keep your fingers and other body parts away from the motor, steering system, wheels and all other moving components.
- Never hitch onto another vehicle or let yourself be pulled or pull anyone or anything while riding the electric ride-on toy.
- Ride only on smooth, flat, dry surfaces such as pavement or level ground without loose debris, such as sand, leaves, rocks or gravel. Water, mud, ice, bumpy, uneven, slick, or rough surfaces could impair traction and contribute to possible loss of control.
- Do not ride on or near hills or steep inclines. Ride only on level ground to avoid tip over.
- Avoid sharp turns, bumps, drainage grates, and other obstacles.
- Do not ride at night or where there is limited visibility.
- Do not ride on surfaces that could be damaged, including carpet and certain types of vinyl or laminate flooring. Dynacraft will not be responsible for damage to such flooring. You should refer to the use and care instructions provided by the manufacturer of your particular flooring product.
- Do not ride on streets, around cars, or in foot or vehicle traffic.
- Regularly check the electric ride-on toy and its components. If any parts are broken or worn, do not ride the electric ride-on toy until you have fixed or replaced the broken or worn parts.

- Do not to allow hands, feet, hair, body parts, clothing, or similar articles to come in contact with wheels or other moving parts.
- Before each cycle of operation, you must perform the pre-operation checks specified in this manual or by the manufacturer, including:
 - That all guards and pads originally supplied by the manufacturer are in proper place and in serviceable condition;
 - That the area that the unit is to be operated in is safe and suitable for safe operation;
 - That all safety labels are in place and understood by everyone, including the riders;
 - That any and all covers or guards supplied by the manufacturer are in place and in serviceable condition; and
 - That tires/wheels are in good condition.
- Avoid sharp bumps, drainage grates, and sudden surface changes.

PRE-RIDE SAFETY CHECKLIST

- Check to make sure that all components are properly secured and are functioning according to the manufacturer's specifications.
- Components must be maintained and repaired and only with the manufacturer's authorized replacement parts. Installation should be performed only by adult, qualified personnel.

USING THE CHARGER

The charger should be examined regularly for damage to the cord, plug, enclosure and other parts. In the event such damage has occurred, the electric ride-on toy should not be charged until the charger has been repaired by qualified personnel or replaced. Use only the supplied, recommended charger.

- Always use caution when charging.
- The charger is not a toy and should be operated by an adult.
- Never operate the charger near flammable materials or liquids, and operate the charger in well-ventilated areas.
- Disconnect the charger and unplug it from the electric ride-on toy when not in use.
- Do not exceed the recommended charging time.
- Always disconnect the charger from the electric ride-on toy prior to wiping down or cleaning the electric ride-on toy with any liquid.

⚠ WARNING: Never modify or alter the electrical system. Risk of fire. Do not bypass fuses, located under the seat. Replace 25A fuse only with 25A fuse and 3A fuse only with 3A fuse. Alterations could cause a fire or explosion resulting in serious injury or death and could also ruin the electrical system.

FAILURE TO HEED THE WARNINGS LISTED ABOVE INCREASES RISK OF POTENTIALLY SERIOUS INJURY. USE THE APPROPRIATE CAUTION WHEN RIDING AND ALWAYS WEAR APPROPRIATE CLOTHING AND SHOES.

BEFORE YOU BEGIN ASSEMBLY

B

NOTE: Remove all packing and items from the display box. Make sure that the power switch is turned "OFF" before assembling the electric ride-on toy.

ESTIMATED ASSEMBLY TIME

You should allow approximately 5 minutes for assembly, not including initial charging time. Initial charging can take approximately 18 hours (see pages 9-10 for charging information).

⚠ WARNING: DO NOT USE NON-ORIGINAL OR NON-RECOMMENDED PRODUCTS WITH YOUR ELECTRIC RIDE-ON TOY.

Altering of the original components or use of non-recommended replacement parts may or may not be compatible with the design and will void the warranty and may cause an unsafe condition resulting in serious injury or death. Contact our Customer Service Team for original replacement parts at dynacraftwheels.com/contact.

If you experience a problem with this product, or are missing a part, please contact our Customer Service Team at dynacraftwheels.com/contact, rather than return this product to the store.

Please identify all parts before assembly and save all packaging material until assembly is complete to ensure that no parts are discarded.

PARTS DIAGRAM

C

Tools Required



Screwdriver
(not included)

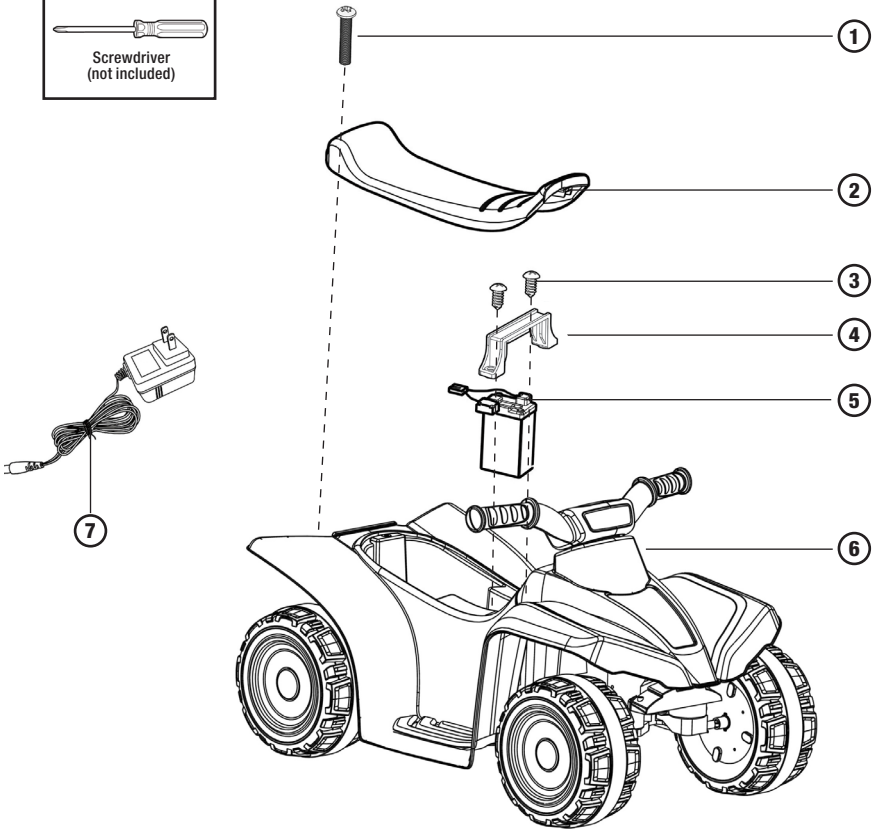

1. M5x15 Machine Screw x1
2. Seat x1
3. 4x12 Round Head Screws x2
4. Battery Retainer x1
5. Battery x1
6. Plastic Body Assembly x1
7. Charger x1

ASSEMBLY

D

Your new ride-on toy has been assembled at the factory, but you will need to connect the power supply.

TOOLS REQUIRED:

Phillips Screwdriver
(not included)

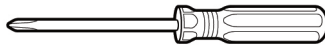

⚠ WARNING: Children can be harmed by small parts, sharp edges and sharp points in the ride-on toy's unassembled state, or by electrical items. In the unassembled state, this package contains small parts. Adult assembly is required; children should not handle parts, or help in assembly of the ride-on toy.

1. POWER SUPPLY CONNECTION

NOTE: The battery is disconnected for shipment to prevent the battery from draining.

- Unscrew the screw on the seat with a screwdriver and remove the seat.
- Plug the power connector into the battery connector as shown, and replace the seat, securing it with the screw removed in the first step.

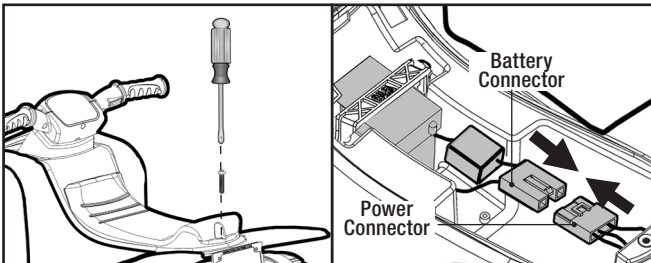

BATTERY CHARGING

IMPORTANT! Before first time use, charge the battery for at least 18 hours. Charge the battery for at least 12 hours after each use of the ride-on toy. Never charge the battery longer than 30 hours. Overcharging or undercharging the battery may shorten battery life and decrease ride-on toy running time.

⚠ WARNING: Battery can fall out and injure a child if the ride-on toy tips over. Always use battery retainer.

PREVENT FIRE

- Never modify the electrical system.
- Alterations could cause a fire resulting in serious injury and could also ruin the electrical system.
- Use of the wrong type battery or charger could cause a fire or explosion, resulting in serious injury.
- Use of non-original components on this ride-on toy could cause overheating, fire or explosion.
- The battery must be handled by adults only.
- The battery is heavy and contains sulfuric acid (electrolyte).
- Dropping the battery could result in serious injury.
- Never allow children to charge the battery.
- Battery charging must be done by adults only. A child could be injured by the electricity involved in charging the battery.
- Never lift or carry the battery by the wires or connector, this can damage the battery and possibly cause a fire resulting in serious injury. Lift and carry the battery by the case only.
- Read the safety instructions on the battery.
- Examine the battery, charger and their connectors for excessive wear or damage each time you charge the battery.
- If damage or excessive wear is detected, do not use the charger or the battery until you have replaced the worn or damaged part.

⚠ CAUTION: Use the charger in dry locations only.

IMPORTANT NOTE

- We recommend that you start charging your battery before beginning assembly of your new ride-on toy.
- The battery must be upright while charging.
- The charger is not a toy. Keep away from children.
- Do not short-circuit the battery.
- You do not need to remove the battery from your ride-on toy to recharge it.
- Before charging the battery, examine the battery case for cracks and other damage which may cause sulfuric acid (electrolyte) to leak during the charging process. If damage is detected, do not charge the battery or use it in your ride-on toy. Battery acid is very corrosive and can cause severe damage to surfaces it contacts.

- Use only an original charger (AC 120V 60Hz) with an output of DC 6V (0.5A) to charge your ride-on toy battery.
 - **NOTE TO ADULTS:** Regularly examine the charger for damage to the cord, plug, housing or other parts that may result in the risk of fire, electric shock or injury.
 - If your battery is old and will not accept a charge, do not leave it in the ride-on toy. Always remove a dead battery from the ride-on toy.
 - After the first charge, recharge the battery for at least 12 hours after each use. Never charge the battery longer than 30 hours. Charge the battery after each use, regardless of how long the ride-on toy was used.
 - Do not allow the battery to run down completely before charging.
 - Charge the battery before storing the ride-on toy.
 - Charge the battery at least once per month, even if the ride-on toy has not been used.
- NOTE:**
- This product has CHARGING PROTECTION: when charging, all the functions will be cut off.
 - Recharge (after initial charge) up to 12 hours. Never charge the battery longer than 30 hours.
 - When the ride-on toy begins to run slowly, recharge the battery.
 - After each use or once a month at minimum if not used, recharge the battery for at least 12 hours, but never more than 30 hours at most.

⚠ CAUTION: Use the charger in dry locations only.

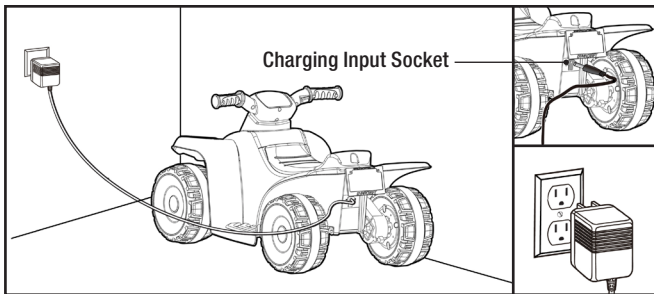

1. Plug the charger port into the input socket (the socket is on the back of the ride-on toy body).
2. Plug the charger plug into a wall outlet. The battery will begin charging.

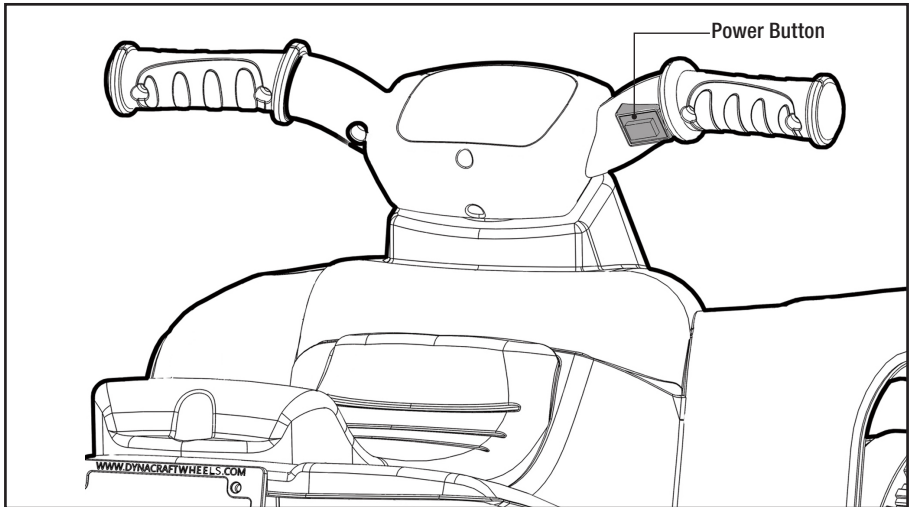

POWER BUTTON

- To move the ride-on toy, press the power button.
- To stop, release the power button.

LIGHT-UP HANDLEBAR

- If your quad features a light-up handlebar, the handlebar or other elements will illuminate when the power button is pressed.

⚠ WARNING: Always stay seated and keep both hands on the handlebar while riding!

IMPORTANT

- Do not let any child touch the wheels or be near them when the ride-on toy is moving.
- To avoid accidents, please inspect the ride-on toy before riding to ensure that it is in proper working order and safe to ride.
- This toy has no brake; to stop, take your hand off the power button on the handlebar.
- Check all the screws, cap nuts and protective coverings regularly and tighten as required. Check plastic parts on a regular basis for cracks or broken pieces.
- Your new battery must be charged for at least 18 hours before you use it in your ride-on toy for the first time.
- Do not wash the ride-on toy with water; clean it with a cloth.

SAFETY PRECAUTIONS

- Children must have adult supervision at all times.
- Do not ride on the road, footpaths, near pools, or bodies of water.
- Do not allow children under the recommended age to ride the ride-on toy; please refer to the age grading.
- Do not allow riders over the recommended weight rating or age grading to use the ride-on toy.
- To stop the ride-on toy, you must take your hand off the button on the handlebar.
- Charging should only be done by an adult.
- An adult must teach the child how to operate the ride-on toy.
- Do not ride on hills or slopes, in sand or on other soft, wet, or slippery surfaces.
- Do not use a different size battery. Use only original or recommended replacement battery.
- The ride-on toy is designed to carry only one rider at a time. Never allow more than one rider or over-load the ride-on toy.
- This product should be assembled and checked by adults before use.

NOTE

- Never store the product in outdoor conditions, never store it in the rain, and never store the product in freezing or below freezing temperatures. These low temperatures will permanently damage the battery.

 WARNING: This ride-on toy has no brakes. Do not ride or park it on any slopes or steep inclines.

⚠ WARNING: Turn power “OFF” before conducting any maintenance procedures. See diagram below, steps 1 and 3.



TOOLS REQUIRED: Phillips Screwdriver
(not included)

HOW TO REPLACE THE BATTERY

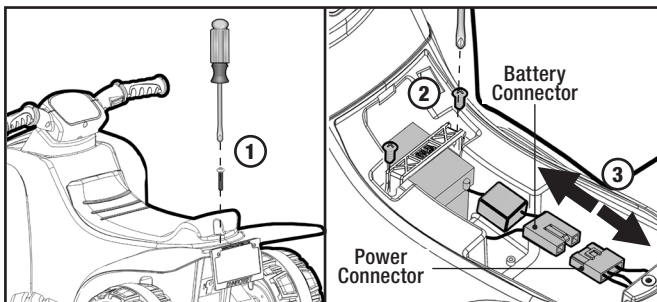

1. Unscrew the screw on the seat with a screwdriver and remove the seat.
2. Use a screwdriver to remove the two screws from the battery retainer.
3. Unplug the power connector (which is connected to the battery).
4. Remove the old battery by carefully lifting it out of the battery compartment.
5. Carefully place the new battery into the battery compartment.
6. Replace the battery retainer and secure it with screws. Plug the power connector into the battery connector, and replace the seat, securing it with the screw removed in step 1.

BATTERY CARE AND DISPOSAL

Do not store the battery in temperatures above 75° F (23.5° C) or below 32° F (0°C).

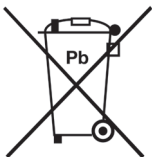

THIS PRODUCT CONTAINS SEALED LEAD ACID BATTERIES WHICH MUST BE RECYCLED IN ACCORDANCE TO YOUR LOCAL AND STATE LAWS. PLEASE CAREFULLY READ AND UNDERSTAND THE FOLLOWING DISPOSAL INSTRUCTIONS:

DISPOSAL: This product contains sealed lead acid batteries which must be disposed of or recycled in an environmentally safe manner. Do not dispose of the batteries in your household trash. Do not dispose of the batteries in a fire, as the battery may explode or leak. The incineration, disposal in landfill and/or placing sealed lead acid batteries with household trash is prohibited by law in most areas. Return exhausted batteries to a state or federal approved lead acid battery recycler or check with your local retailer of vehicle batteries. If you live in Florida, Minnesota or various other states, it is prohibited by law to throw away lead-acid batteries in the municipal waste stream. Check local laws for proper handling and recycling of lead-acid batteries.

⚠ WARNING:

- Do not mix old and new batteries. Do not mix alkaline, standard (carbon-zinc), or rechargeable (nickel-cadmium) batteries.
- If a battery leak develops, avoid contact with the leaking acid and place the battery in a plastic bag. See instructions above for proper disposal. If acid comes into contact with skin or eyes, flush with cool water for at least 15 minutes and contact a physician.
- If acid is internally ingested, give water, milk of magnesia or egg whites immediately. Never give emetics or induce vomiting. Call a physician.

CARE

- Leaving the battery in a discharged condition will ruin it.
- Always remove an exhausted battery from the ride-on toy. Battery leakage and corrosion can damage the ride-on toy.
- Do not store the battery in temperatures above 75° F (23.5° C) or below 32° F (0° C).
- Use only a 6V 4AH battery. Remember to charge the new battery for at least 18 hours before first use.
- Prevent the battery from moving freely inside the battery compartment. Always use the battery retainer to secure the battery in the battery compartment.
- Examine the battery, charger and their connectors for excessive wear or damage each time you charge the battery. If damage is detected, do not use the charger or the battery until you have replaced the worn or damaged part.

MAINTAINING YOUR RIDE-ON TOY

Occasionally use a lightweight oil to lubricate moving parts such as wheels and the steering linkages.

Park the ride-on toy indoors or cover it with a tarp to protect it from wet weather.

Keep the ride-on toy away from sources of heat, such as stoves and heaters. Plastic parts may melt.

ADULTS ONLY: Recharge the battery after each use. Recharge the battery at least once a month when the ride-on toy is not being used.

DO NOT wash the ride-on toy with a hose. **DO NOT** wash the ride-on toy with soap and water.

DO NOT drive the ride-on toy in rainy or snowy weather. Water will damage the motor, electrical system, and battery.

DO NOT store the ride-on toy, outside in the rain or exposed to the elements. The ride-on toy should be stored inside or covered to protect it from exposure to the elements.

Clean the ride-on toy with a soft, dry cloth. To restore shine to plastic parts, use a non wax furniture polish. **DO NOT** use car wax. **DO NOT** use abrasive cleaners, or cleaners that contain ammonia or isopropyl alcohol.

DO NOT drive the ride-on toy in loose dirt, sand or fine gravel, which could damage moving parts, motors or the electric system.

⚠ WARNING: Charge the battery before storing your ride-on toy, otherwise the battery will be damaged.

ABOUT FUSES

Your ride-on toy is equipped with a safety fuse. The fuse is a self-resetting safety device which automatically “trips” and shuts down operation of the ride-on toy if the ride-on toy is overloaded or the operating conditions are too severe. Once a fuse has “tripped,” **do not continuously push on the power button.** The fuse will automatically reset itself after approximately 2 minutes and allow the ride-on toy to resume normal operations. To avoid repeated automatic shut-downs, do not overload the ride-on toy by exceeding the 40lb (18kg) maximum weight capacity or by towing anything behind the ride-on toy. Avoid severe driving conditions, such as driving up slopes or running into fixed objects, which can cause the wheels to stop spinning while power is still being supplied to the motor.

TROUBLESHOOTING GUIDE

Problem	Possible Cause	Solution
Ride-on toy does not run	Undercharged battery	<p>Charge the battery. A new battery should have been charged for at least 18 hours before using the ride-on toy for the first time. After first-time use, recharge the battery for at least 12 hours after each use. Never charge the battery longer than 30 hours.</p> <p>Check all connectors. Make sure the battery connector is tightly plugged into the power connector, and that the charger is plugged into the wall outlet.</p> <p>Make sure that there is power flow to the wall outlet.</p>
	Tripped fuse	<p>The fuse may “trip” and shut down operation of the ride-on toy if the ride-on toy is overloaded or the driving conditions are too severe. Once a fuse has “tripped”, do not continuously push on the power button. The fuse will automatically reset itself after approximately 2 minutes and allow the ride-on toy to resume normal operations. To avoid repeated automatic shutdowns, do not overload the ride-on toy by exceeding the 40 lb maximum weight capacity or by towing anything behind the ride-on toy. Do not drive up hills or run into fixed objects, which can cause the wheels to stop spinning while power is still being supplied to the motor.</p>
	Electrical switch damage	<p>The electrical switches can become corroded due to exposure to water or moisture, or can jam due to loose dirt, sand or gravel.</p>
	Dead battery	<p>Check all wires and connectors. Make sure the battery connector is tightly plugged into the power connector and that there are no loose wires around the motor.</p> <p>If your battery is old or if you have not followed Battery Care instructions, your battery may be dead. Replace only with an original 6V 4AH battery. Do not use non-original substitute parts.</p>
	Motor damage	<p>Please contact our Customer Service Team. dyncraftwheels.com/contact</p>

Problem	Possible Cause	Solution
Ride-on toy was running but suddenly stopped	Loose wires or connectors	Check all wires and connectors. Make sure the battery connector is tightly plugged into the power connector, and that there are no loose wires around the motor.
	Tripped fuse	The fuse may “trip” and shut down operation of the ride-on toy if the ride-on toy is overloaded or the driving conditions too severe. Once a fuse has “tripped”, do not continuously push on the power button . The fuse will automatically reset itself after approximately 2 minutes and allow the ride-on toy to resume normal operations. To avoid repeated automatic shutdowns, do not overload the ride-on toy by exceeding the 40 lb maximum weight capacity or by towing anything behind the ride-on toy. Do not drive up hills or run into fixed objects, which can cause the wheels to stop spinning while power is still being supplied to the motor.
Short run time (Less than 15 minutes per charge)	Undercharged battery	Charge the battery. A new battery should have been charged for at least 18 hours before using the ride-on toy for the first time. After first-time use, recharge the battery for at least 12 hours after each use. Never charge the battery longer than 30 hours. Check all wires and connectors. Make sure the battery connector is tightly plugged into the power connector, and that the charger is plugged into the wall. Make sure that there is power flow to the wall outlet.
	Overcharged battery	Do not charge the battery longer than 30 hours. If you suspect that your battery is damaged as a result of overcharging, change with one new original 6V 4AH battery. Do not use non-original substitute parts.
	Battery is old and will not accept full charge	Even with proper care, a rechargeable battery does not last forever. Average battery life is 1 to 3 years depending on ride-on toy use and use conditions. Replace only with an original 6V 4AH battery. Do not use non-original substitute parts.
	Motor damage	Please contact our Customer Service Team. dynacraftwheels.com/contact
	Tripped fuse	The fuse may “trip” and shut down operation of the ride-on toy if the ride-on toy is overloaded or the driving conditions are too severe. Once a fuse has “tripped”, do not continuously push on the power button . The fuse will automatically reset itself after approximately 2 minutes and allow the ride-on toy to resume normal operations. To avoid repeated automatic shutdowns, do not overload the ride-on toy by exceeding the 40 lb maximum weight capacity or by towing anything behind the ride-on toy. Do not drive up hills or run into fixed objects, which can cause the wheels to stop spinning while power is still being supplied to the motor.

Problem	Possible Cause	Solution
Ride-on toy runs sluggishly	Undercharged battery	Charge the battery. A new battery should have been charged for at least 18 hours before using the ride-on toy for the first time. After first-time use, recharge the battery for at least 12 hours after each use. Never charge the battery longer than 30 hours. Check all connectors. Make sure the battery connector is tightly plugged into the power connector, and that the charger is plugged into the wall outlet. Make sure that there is power flow to the wall outlet.
	Battery needs charging	Be sure to charge the battery after each use.
	Ride-on toy is overloaded	Make sure you do not overload the ride-on toy by allowing more than one rider at one time, exceeding the 40 lb maximum weight capacity, or by towing objects behind the ride-on toy. If the ride-on toy is overloaded, the fuse may “trip”, and automatically shut down operation of the ride-on toy for approximately 2 minutes. Correct the condition that lead to the overload and adjust the driving conditions to prevent repeated automatic shutdowns.
	Driving conditions too stressful	Use only on level ground.
Sometimes the ride-on toy doesn't run, but other times it does	Loose wire or connector	Check all wires around the motors and all connectors to make sure they are tight.
When the button is pressed, the ride-on toy won't run without a push		Check all wires around the motors and all connectors to make sure they are tight.
The battery's safety fuse constantly “trips”, but the ride-on toy is not overloaded and the driving conditions are not severe	Damaged battery	Replace with new battery. Replace only with an original 6V 4AH battery. Do not use non-original substitute parts.

Problem	Possible Cause	Solution
Charger gets warm during use	<p>It is normal for some chargers to get warm during use and is not reason for concern</p> <p>Some chargers do not get warm during use</p>	<p>No action required.</p> <p>If your charger does not get warm during use, it does not mean that it is not working properly.</p>
Battery makes a sizzling or gurgling noise when charging	<p>It is normal for some batteries to make noise and swell slightly while charging and is not reason for concern</p>	<p>No action required.</p> <p>If your battery does not make noise or swell slightly while charging, it does not mean that it is not working properly.</p>

FREE WARRANTY UPGRADE WITH REGISTRATION

CONSUMER ACTION REQUIRED
dynacraftwheels.com/register

UPGRADE YOUR WARRANTY WITH PRODUCT REGISTRATION

Free warranty upgrade with online registration at dynacraftwheels.com/register.

We respect your privacy. Any information collected by Dynacraft Wheels will never be shared with any other company or organization. See Dynacraft's privacy policy for further information: dynacraftwheels.com/dynacraft-privacy-policy.

BENEFITS OF SIGNING UP FOR FREE EXTENDED WARRANTY

- Simple, quick sign up at dynacraftwheels.com/register (proof of purchase required).
- Extra 6 months battery coverage from date of purchase.
- Extra 60 days of coverage on electric ride-on parts subject to wear and tear, from date of purchase.
- Transportation charges on replacement parts waived for the Limited Warranty period. See Limited Warranty for details.

For further enquiries call Customer Service at 1-800-551-0032 or visit dynacraftwheels.com/contact

LIMITED WARRANTY

This Limited Warranty (“Warranty”) extends only to the original retail purchaser, who must provide proof of purchase to validate any claim. As noted below, certain aspects of this Warranty can be extended free of charge to original retailer purchasers who also register their product using the provided online registration form. Proper registration via Dynacraft’s online registration form is the only way to obtain these noted extensions. This Warranty is not transferable to anyone else and is the only warranty for your Dynacraft product, to the extent permitted by law. No other express or implied warranty is given, and except to the extent prohibited by applicable law, any implied warranty of merchantability or fitness for a particular purpose on this product is hereby disclaimed. Part or model specifications are subject to change without notice. By purchasing and using your new electric ride-on toy you agree to be bound by the terms of this Warranty as set out below. This Warranty is subject to change without notice.

What does this Limited Warranty cover? This Warranty covers all parts of the electric ride-on toy to be free from defects in workmanship and materials. This Warranty is only effective if: the electric ride-on toy is used under normal conditions for its intended purposes, by a person that properly fits and is capable of controlling the vehicle; and the electric ride-on toy receives all necessary maintenance and adjustments.

What is not covered by this Limited Warranty? This Warranty does not include labor and transportation charges. You, the original purchaser will be responsible for labor or transportation charges associated with the repair or replacement of any parts found to be eligible for warranty coverage. Those original purchasers who qualify for the extended version of this Warranty will have transportation charges waived for the duration of the Limited Warranty period. This warranty does not cover damage caused by normal wear and tear, crash collision, misuse, abuse, neglect, improper assembly, improper maintenance, lack of maintenance, alteration, or any similar damage to the ride-on toy.

This Warranty will be void if the electric ride-on toy is ever: installed with a motor or modified in any other way; rented or used for commercial purposes; or used in a manner contrary to the instructions in the Owner’s Manual included with this product. Dynacraft will not be liable for incidental or consequential loss or damage, due directly or indirectly from use of this product.

For how long does this Limited Warranty last? The ride-on toy, with the exception of the battery and cosmetic parts as described below, is warranted against defective materials or workmanship for a period of one year from the original date of purchase.

The battery is warranted against defective materials or workmanship for a period of six months from the original date of purchase. For those original purchasers who qualify for the extended version of this Warranty, the battery is warranted for a period of one year from date of purchase.

Parts and accessories considered to be cosmetic and not essential for the operation of this electric ride-on toy as well as those parts and accessories subject to normal wear and tear are warranted against defective materials or workmanship for a period of 30 days from the original date of purchase. An original receipt confirming the original date of purchase is required to validate your warranty. For those original purchasers who qualify for the extended version of this Warranty, cosmetic/wear-and-tear components are covered for 90 days from date of purchase. Parts and accessories considered cosmetic include, but are not limited to: mirrors; doors; fenders; stickers/decals; decorations/accessories; and fur Coverings (for plush animal electric ride on toys). Parts and accessories subject to wear and tear include, but are not limited to wheels and wheel components.

What will Dynacraft do to honor this Limited Warranty? Dynacraft will replace any component or battery confirmed to be defective and eligible for warranty replacement with the same or a functionally equivalent part. You, the original purchaser will be responsible for any and all labor or transportation charges connected with the replacement or repair of the ride-on toy or any covered parts.

How do you make a claim under this Limited Warranty? Warranty claims should be submitted via Dynacraft’s online portal at dyncraftwheels.com/contact. Please have your proof of purchase available before contacting to validate your claim. Products can be registered at dyncraftwheels.com/register.

DO NOT RETURN THIS ITEM TO THE STORE
CONTACT DYNACRAFT CUSTOMER SERVICE FOR ASSISTANCE

dyncraftwheels.com/contact
or 1-800-551-0032 9AM–5PM ET

Please have the following information available:

Model Number

Example: 8000-00

Production Date

Example: MM.DD.YYYY

Serial Number

Example: DXXXX00000000

This information can be found on a white sticker in the battery compartment or under your unit, and is required to help us handle your request effectively.



DYNACRAFT[®]

Dyncraft BSC, Inc.
1501 Crossgate Road
Port Wentworth, GA 31407
Call Toll Free 1-800-551-0032
Monday – Friday 9AM to 5PM EST
dyncraftwheels.com
©2021 All rights reserved

2021 Printed in China

BM123