

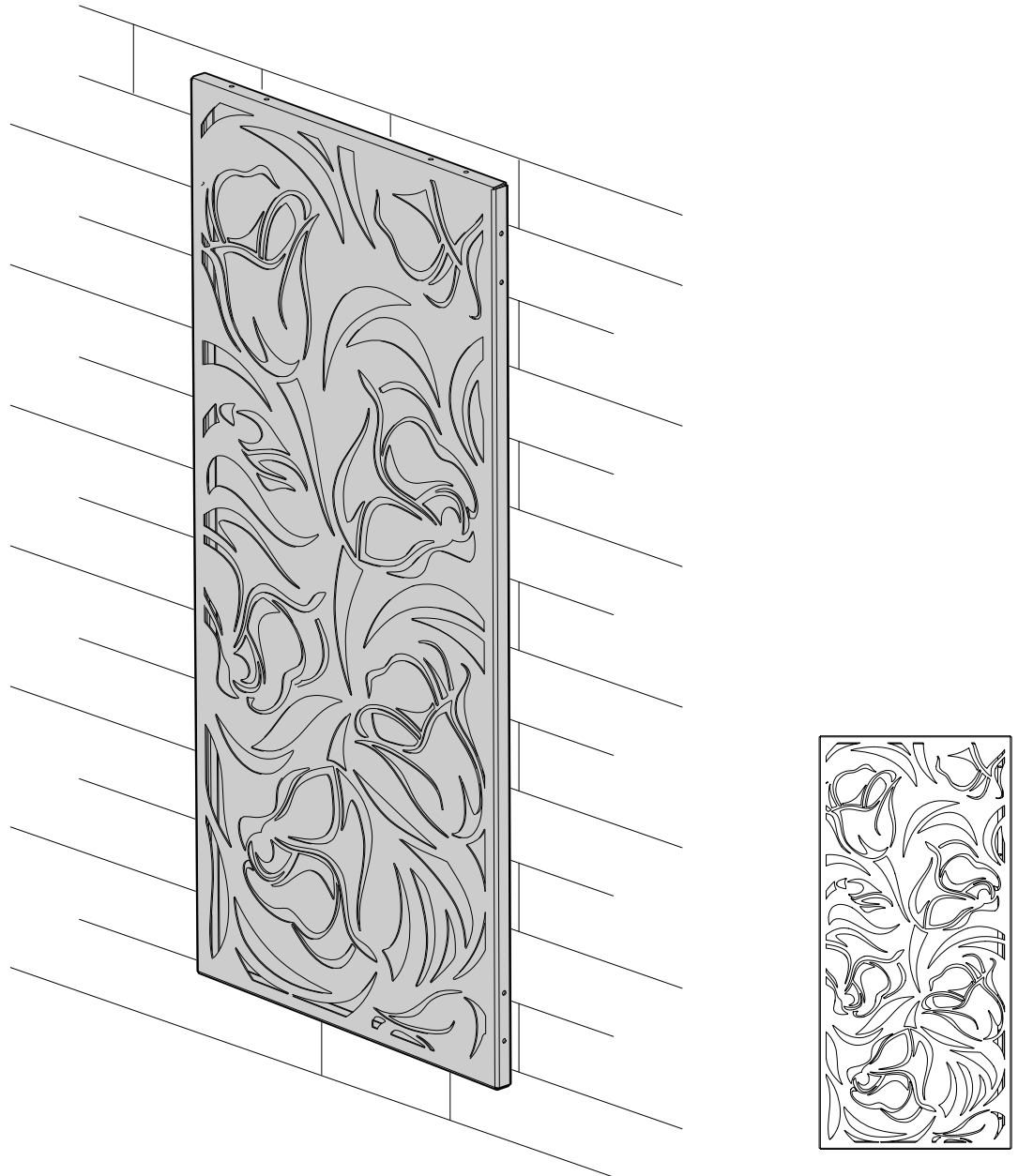

**METAL**  
*Garden Screen*

## **INSTALLATION WITH STAND OFF BRACKETS**



### **TOOLS REQUIRED**

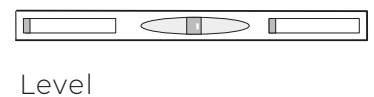
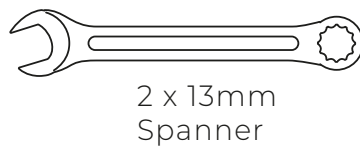
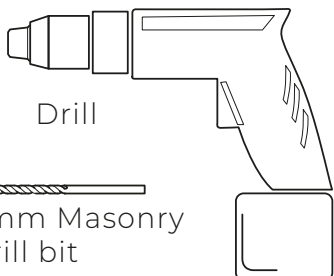



# INSTALLATION

**1** Install the top (2) stand off brackets.

Position the first stand off bracket, mark hole position. Drill holes. Repeat process for second stand off bracket.

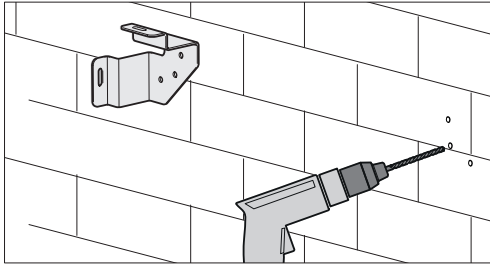

Be sure to have same distance of screen and bracket.

### PRO TIPS

Ensure colour coating is not damaged by wall or bolts.

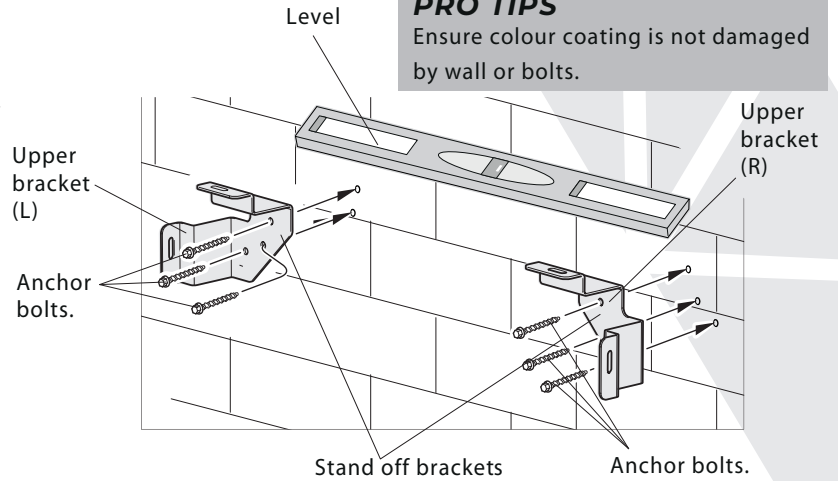

**2** Bolt lower stand off brackets to the bottom of the screen.

### PRO TIPS

Leave mounted anchor bolts loose until step 5.

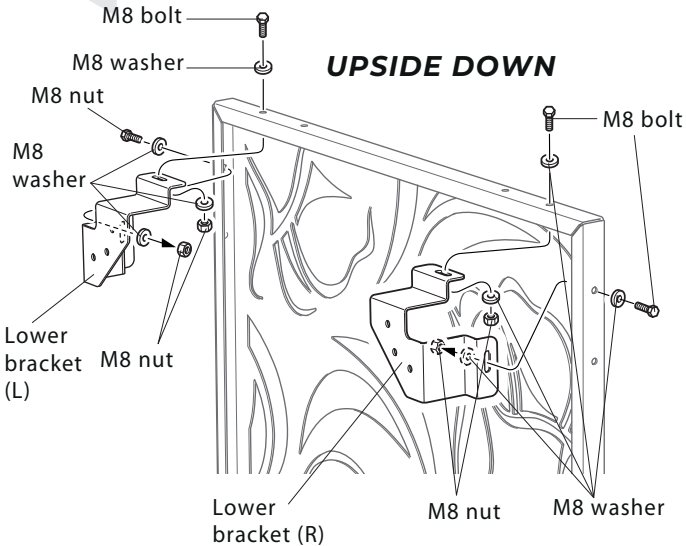

**3** Position the screen on top brackets and mark lower hole positions on the wall.

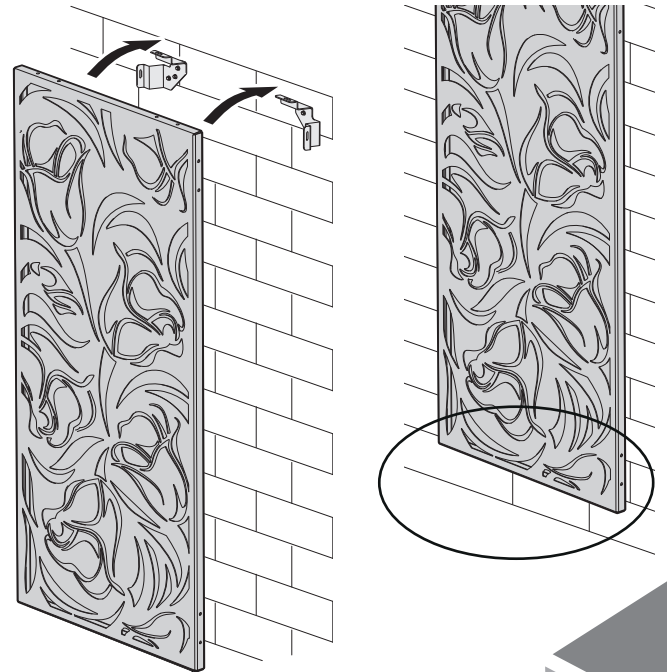

**4** Remove screen and drill lower bracket holes.

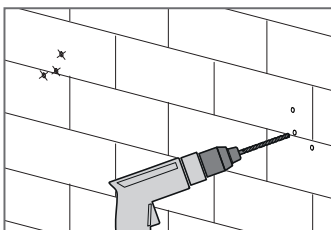
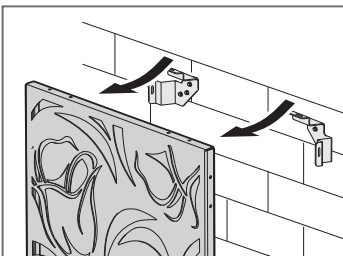

**5** Hang the screen to the bracket. Bolt lower stand off brackets into the wall using anchor bolts.

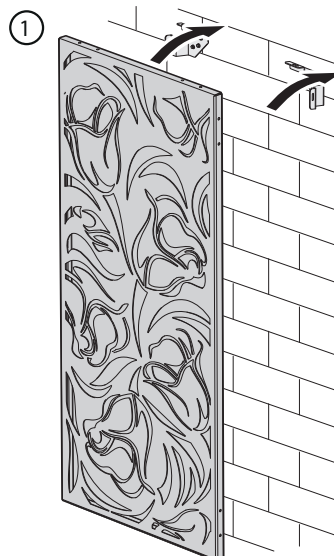

### PRO TIPS

Ensure colour coating is not damaged by wall or bolts.

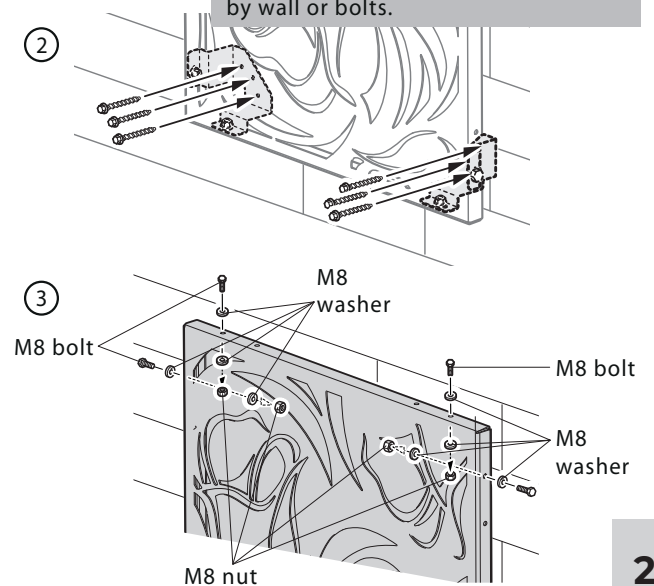





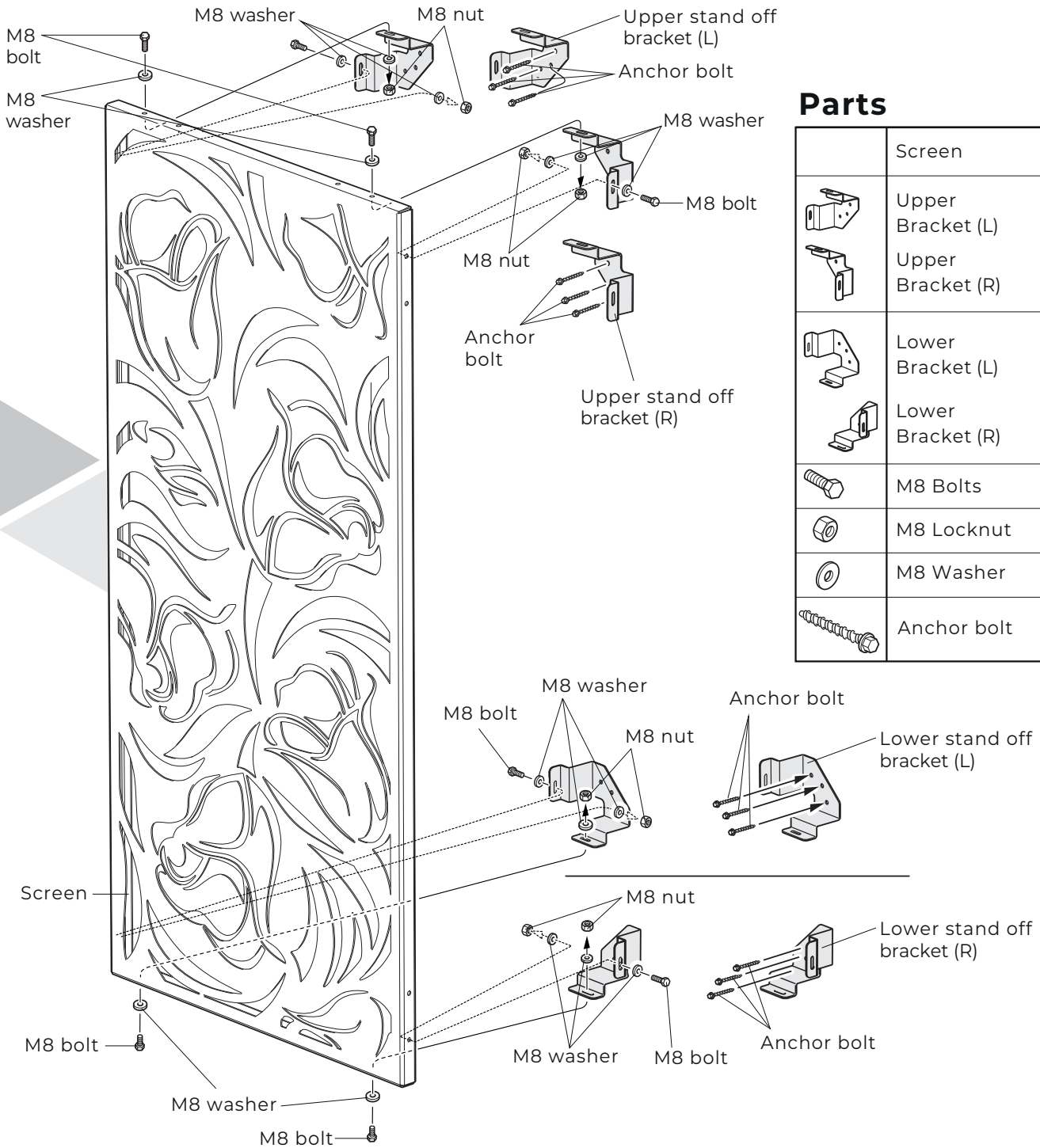





# PARTS VIEW



## Parts

	Screen	x 1
	Upper Bracket (L)	x 1
	Upper Bracket (R)	x 1
	Lower Bracket (L)	x 1
	Lower Bracket (R)	x 1
	M8 Bolts	x 8
	M8 Locknut	x 8
	M8 Washer	x 16
	Anchor bolt	x 12



**METAL**  
Garden Screen

## Metal Garden Screen Ltd.

Metal Garden Screen, Unit 2381  
37 Westminster Buildings, Theatre Square  
Nottingham. NG1 6DQ

Tel: +44 800 044 8412

Email: [sales@metalgardenscreen.co.uk/](mailto:sales@metalgardenscreen.co.uk)

Website: <https://metalgardenscreen.co.uk/>

REGISTERED IN ENGLAND  
Company number: 9270750

