



PNOT J30309-2016
Révision : c
01/10/18

NOTICE DE MONTAGE ET D'UTILISATION
ASSEMBLY INSTRUCTIONS AND USER GUIDE
MONTAGE- EN GEBRUIKSHANDLEIDING
AUFBAU-UND BENUTZUNGS-ANLEITUNG

SERRE DE JARDIN 3m x 3m
3m x 3m HOBBY GREENHOUSE
TUINKAS 3m x 3m
HOBBYGEWÄCHSHÄUSER 3m x 3m

EN CAS DE RECLAMATION AVEC NOS PRODUITS, CONTACTEZ VOTRE REVENDEUR ET COMPLETEZ LA FICHE DE RECLAMATION (VOIR AU DOS).

IN CASE OF DISSATISFACTION WITH OUR PRODUCTS, PLEASE CONTACT YOUR SALES OUTLET AND FILL IN THE "COMPLAINT SHEET" (see behind)

NEEM VOOR KLACHTEN CONTACT OP MET UW VERKOOPPUNT, MET HET BIJGAANDE "KLACHTENFORMULIER" (kijk op de achterkant van deze handleiding)

FÜR JEDE REKLAMATION BITTEN WIR SIE IHRE VERKAUFSTELLE MIT DEM BEILIEGENDEN REKLAMATIONSFORMULAR ZU KONTAKTIEREN.

INSTRUCTIONS DE POSE, D'UTILISATION, D'ENTRETIEN ET DE MAINTENANCE

RECOMMANDATIONS GENERALES

Vous venez de commander une serre RICHEL et nous vous en remercions. Veuillez consulter scrupuleusement cette notice et respecter les consignes de pose et d'utilisation qui sont indiquées. Il est très important de lire toute la notice avant de commencer le montage.

Leur non-respect dégagerait le vendeur de toute responsabilité.

UN MONTAGE DE MAUVAISE QUALITE PEUT INFLUER CONSIDERABLEMENT SUR LA RESISTANCE DE LA SERRE.

RECEPTION DU MATERIEL

Nous vous recommandons de vérifier le contenu des colis à l'aide du tableau récapitulatif de pièces que vous trouverez en début de notice de montage.

INSTRUCTIONS FOR ASSEMBLY, USE, CARE AND MAINTENANCE

GENERAL RECOMMENDATIONS

You have just ordered a RICHEL greenhouse. Please read this instruction carefully and follow the advice given concerning the construction, use, care and maintenance. The supplier will not accept responsibility in the event of non compliance.

POOR CONSTRUCTION QUALITY CAN CONSIDERABLY REDUCE THE STRUCTURAL RESISTANCE OF THE GREENHOUSE.

RECEIVING THE MATERIAL

It is recommended to verify the contents of the packages with the help of the summary table that you will find at the beginning of the assembly instructions guide.

INSTRUCTIES VOOR INSTALLATIE, GEBRUIK, REINIGING EN ONDERHOUD

ALGEMENE AANBEVELINGEN

U heeft een RICHEL kas besteld en wij willen u daarvoor bedanken. Neem zorgvuldig deze handleiding door en neem de installatie- en gebruiksinstructies die erin staan vermeld in acht. Het is belangrijk om de handleiding volledig te lezen voordat u met de montage begint.

In geval van niet in acht nemen van de instructies vervalt iedere verantwoordelijkheid van de verkoper.

EEN SLECHTE MONTAGE VAN DE KAS KAN DE WEERSTAND ERVAN AANZIENLIJK BEÏNVLOEDEN.

ONTVANGST VAN HET MATERIAAL

Wij raden u aan om de inhoud van de pakketten te verifiëren met behulp van de overzichtstabel met onderdelen die u in het begin van de montagehandleiding vindt.

INSTRUKTIONEN FÜR DIE BENUTZUNG, INSTANDHALTUNG UND WARTUNG

ALLGEMEINE EMPFEHLUNGEN

Sie haben einen RICHEL Gewächshaus bestellt ; bitte lesen Sie diese Beschreibung aufmerksam durch und beachten Sie die darin gegebenen Anweisungen zur Aufstellung, Benutzung, Instandhaltung und Wartung. Lesen Sie vor Montage unbedingt die gesamte Bedienungsanleitung!

Die Nichtbeachtung entbindet den Verkäufer von jeglicher Verantwortung.

EINE MONTAGE VON SCHLECHTER QUALITÄT KANN SICH BETRÄCHTLICH AUF DIE STANDFESTIGKEIT DES GEWÄCHSHAUS AUSWIRKEN.







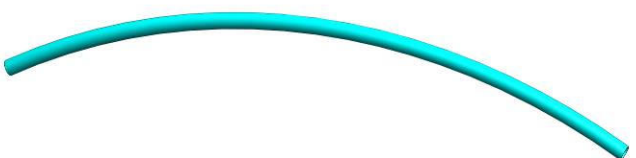
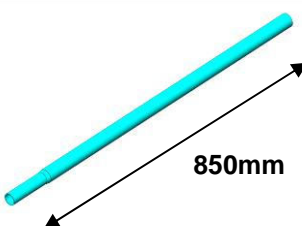
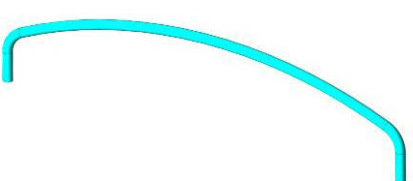
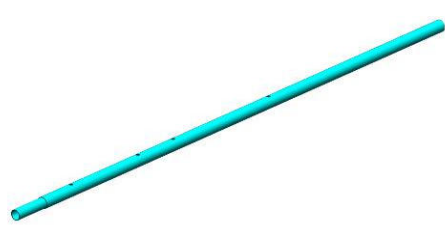
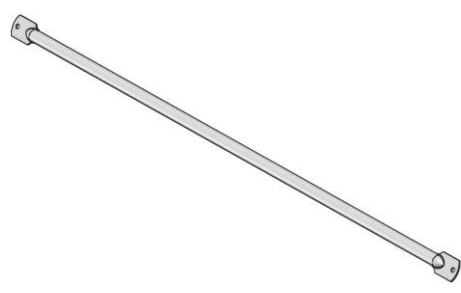
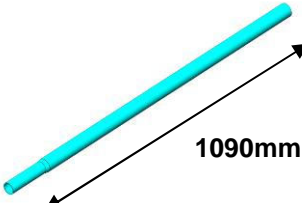
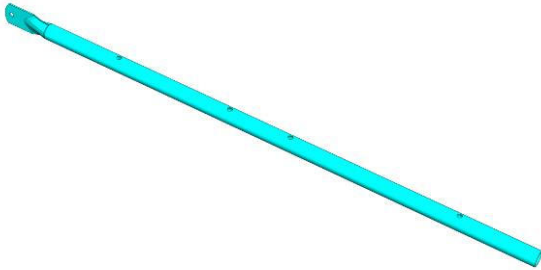
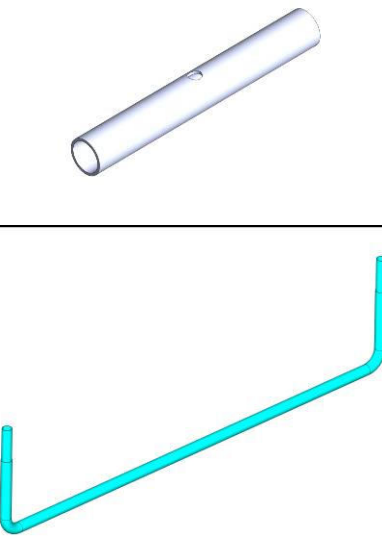
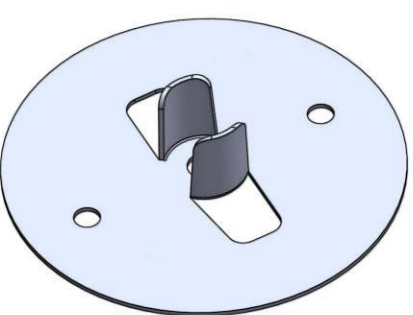
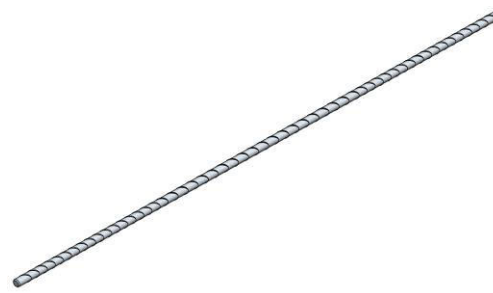

MATERIALANNAHME

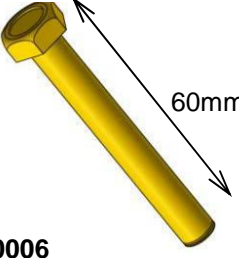
Wir empfehlen Ihnen, den Inhalt der Pakete anhand der Stückliste, die Sie am Anfang der Montageanleitung finden, zu überprüfen.

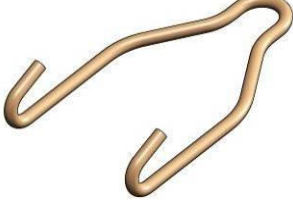



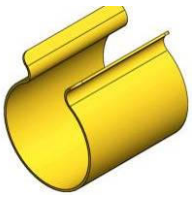
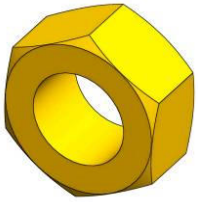
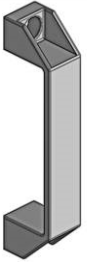

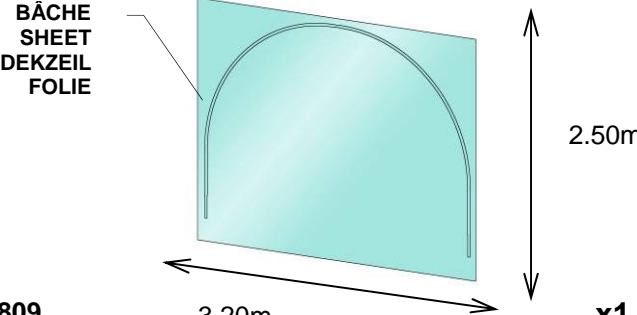
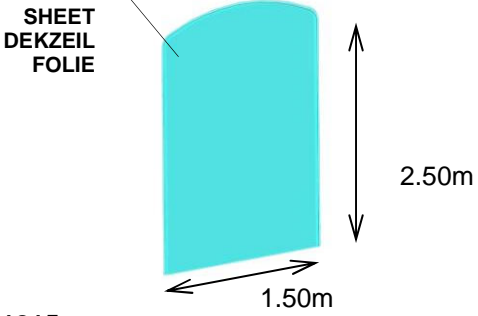
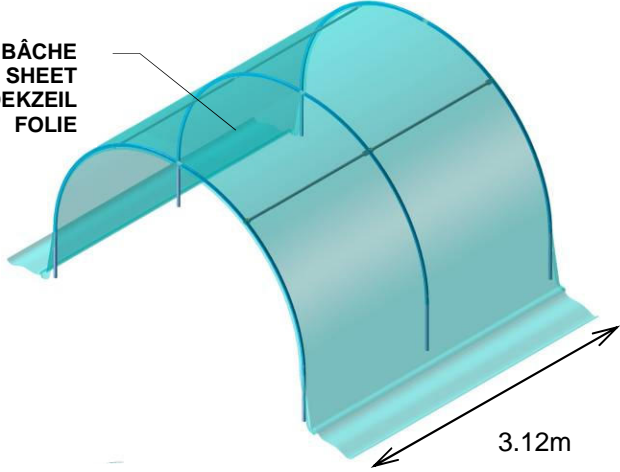
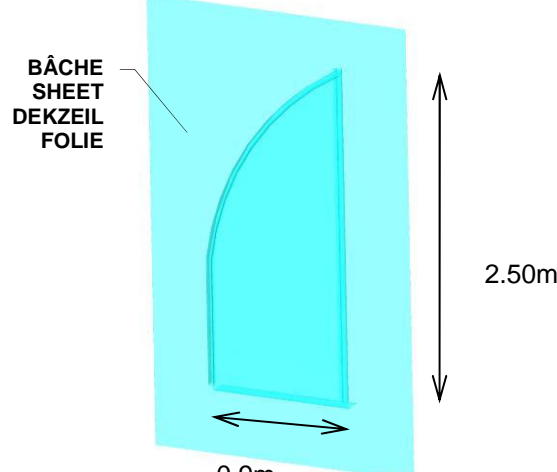





LISTE DES PIÈCES
PARTS LIST
LIJST VAN ONDERDELEN
STÜCKLIST

 <p>P110598 x9</p>	 <p>P110542 x6</p>
 <p>P110603 x1</p>	 <p>P110601 x2</p>
 <p>P240062 x4</p>	 <p>P110424 x2</p>
 <p>P110602 x2</p>	 <p>P250005 x6</p>
 <p>P110600 x1</p>	 <p>P620717 x6</p>
	<p>P620724 x6</p>

**LISTE DES PIÈCES
PARTS LIST
LIJST VAN ONDERDELEN
STÜCKLIST**

 <p>P710006 x2</p>	 <p>P710163 x12</p>	 <p>P610046 1.50m</p>	 <p>P720013 x4</p>
 <p>P410007 x2</p>	 <p>P620842 x6</p>	 <p>P720082 14m</p>	 <p>P730001 x2</p>
 <p>P620003 x50</p>	 <p>P710010 x14</p>	 <p>P730182 x1</p>	 <p>P620227 x2</p>
 <p>BÂCHE SHEET DEKZEIL FOLIE</p> <p>P881809 x1</p>	 <p>BÂCHE SHEET DEKZEIL FOLIE</p> <p>P881815 x1</p>		
 <p>BÂCHE SHEET DEKZEIL FOLIE</p> <p>P881817 x1</p>	 <p>BÂCHE SHEET DEKZEIL FOLIE</p> <p>P881828 x2</p>		

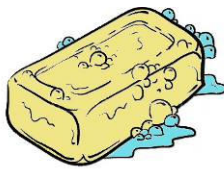
OUTILLAGE NECESSAIRE (Non fourni)
NECESSARY TOOLS (Not supplied)
BENODIGD GEREEDSCHAP (Niet meegeleverd)
BENÖTIGT WERKZEUGE (Nicht geliefert)

			
		 X 2	
			

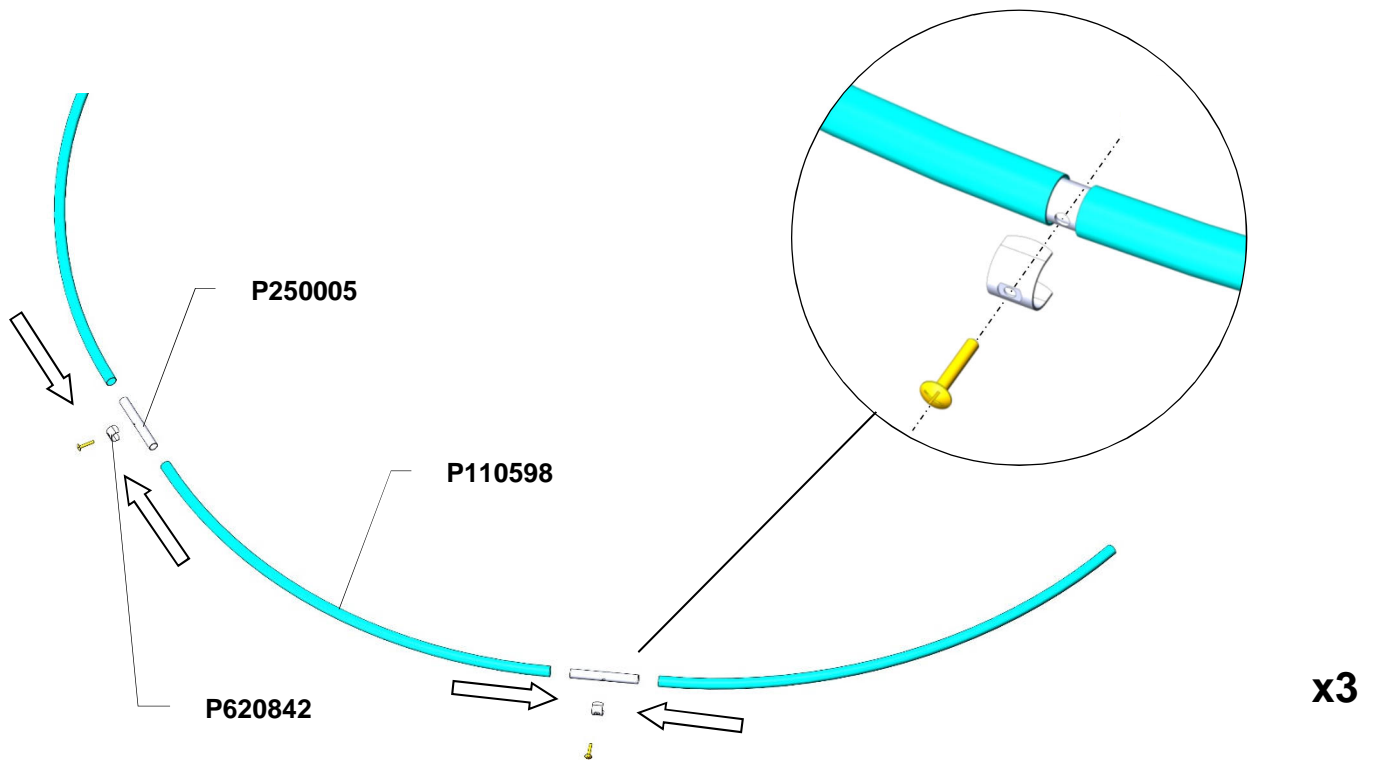

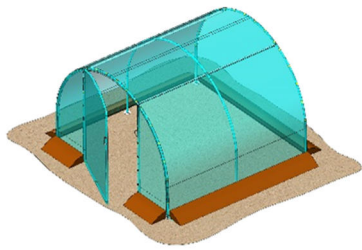

A = B

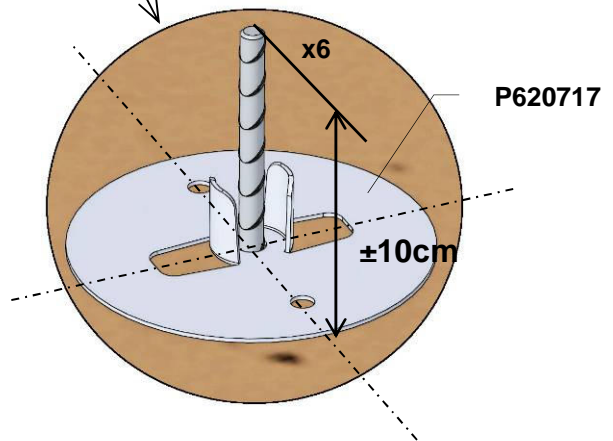
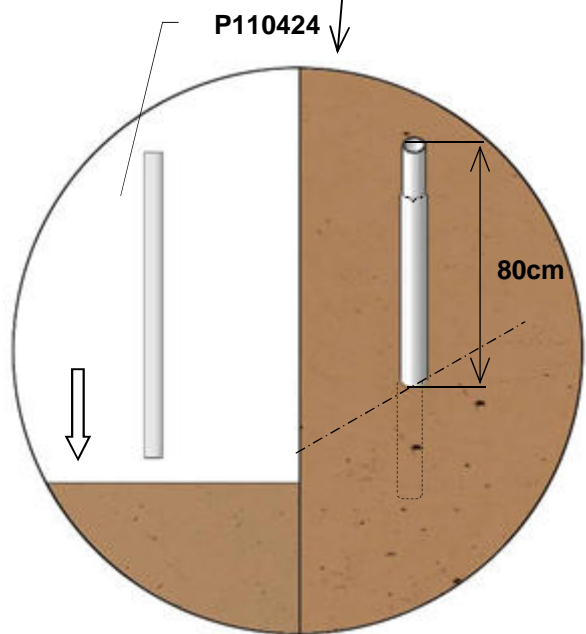
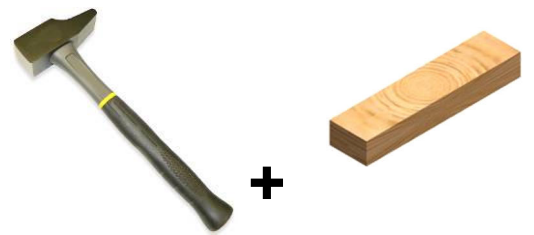
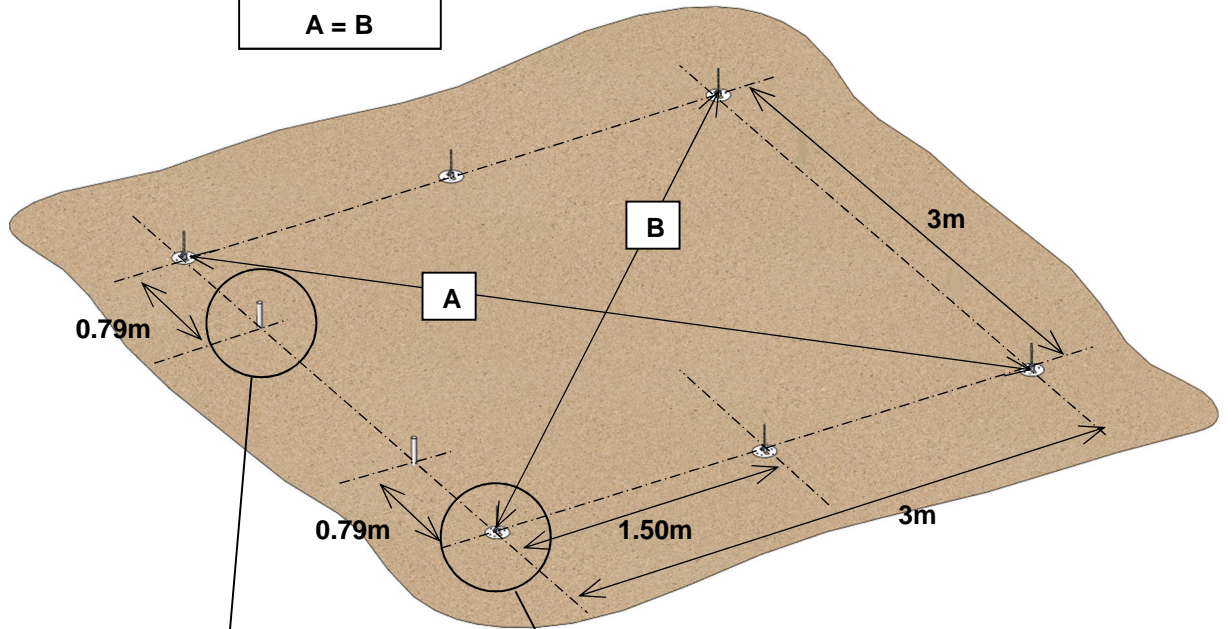

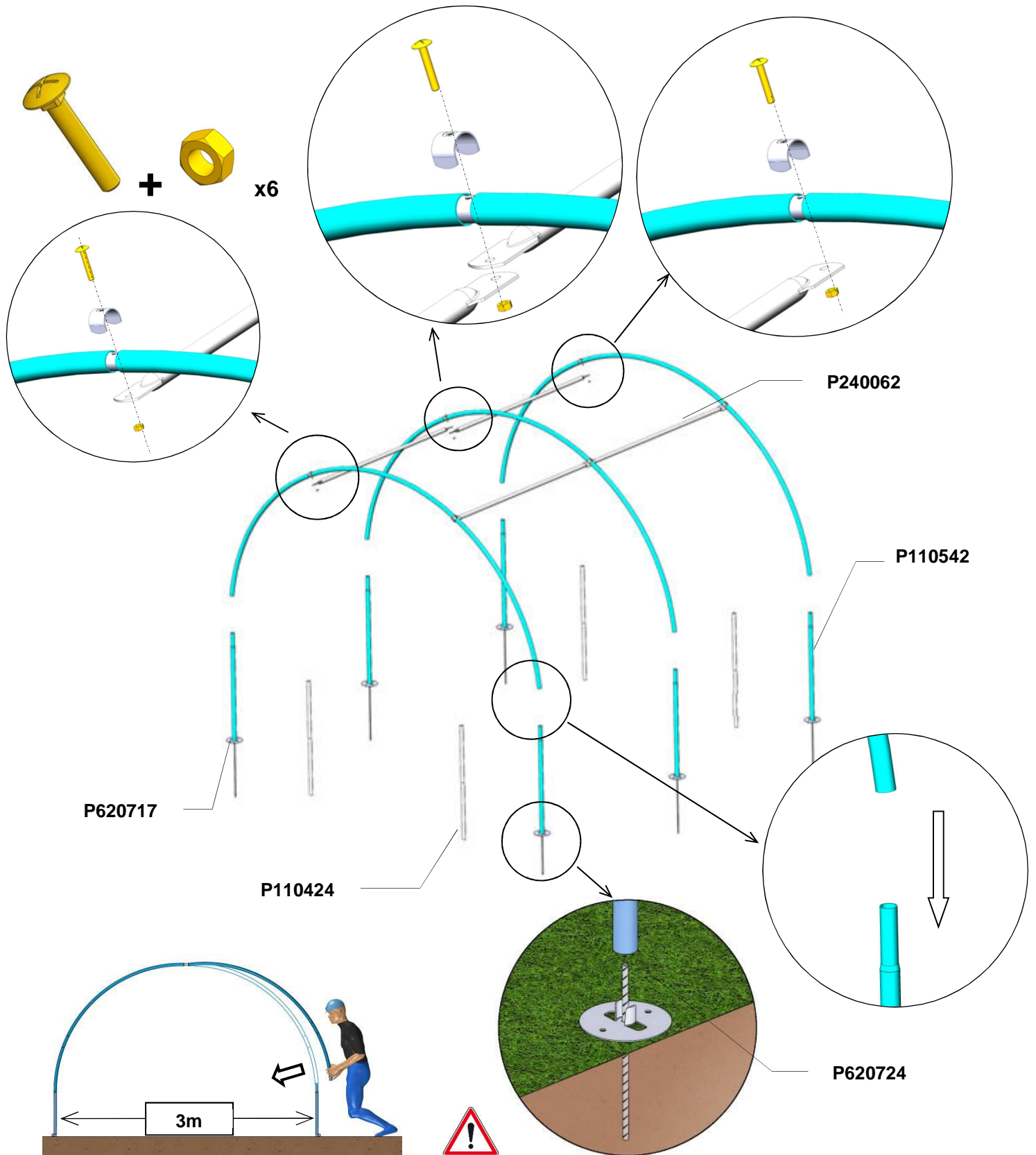

- Mettre en place les pièces P110542 au sol, assembler l'arceau P110598 sur un P110542 puis la première jonction P250005 + P620842, le deuxième P110598, la deuxième jonction et enfin le dernier P110598. Finaliser comme le schéma ci-contre.
- Put parts P110542 on the ground, assemble P110598 arch on a P110542 then the first junction P250005 + P620842, the second P110598, the second junction and finally the last P110598. Finalize as the diagram.
- Legen Sie die Teile P110542 auf den Boden, montieren Sie den Bogen P110598 an das Teil P110542, dann die erste Verbindung P250005 + P620842, die zweite P110598, die zweite Verbindung und schließlich die letzte P110598. Fertigstellen wie im nebenstehenden Diagramm.
- Plaats de stukken P110542 op de grond, monteer de P110598-boog op een P110542 en vervolgens de eerste kruising P250005 + P620842, de tweede P110598, de tweede kruising en ten slotte de laatste P110598. Finaliseer als het diagram hiernaast.

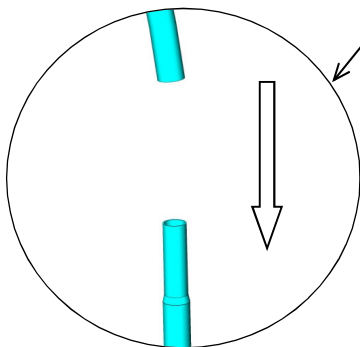
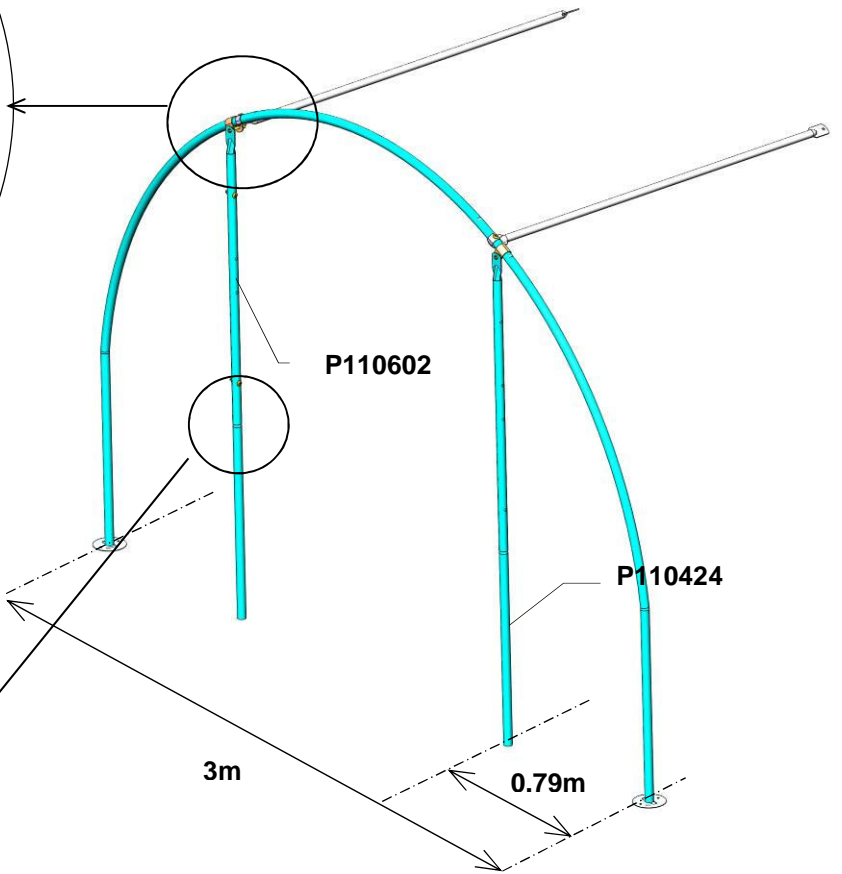
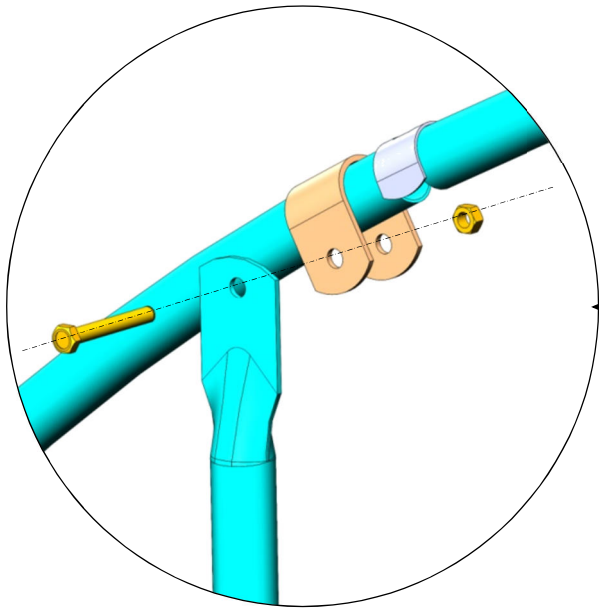
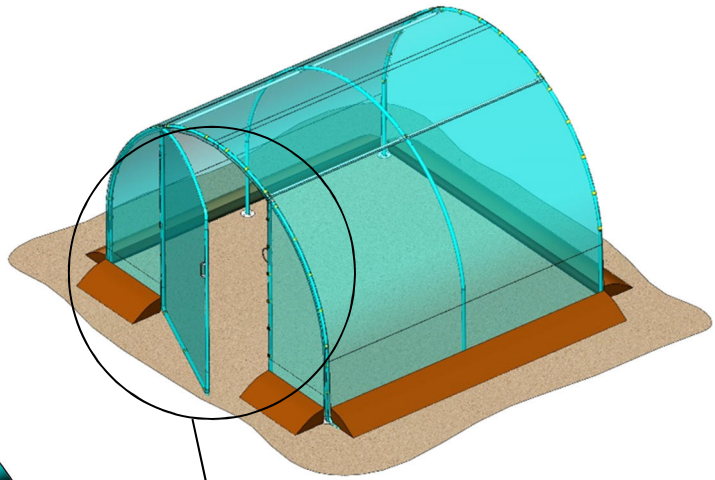
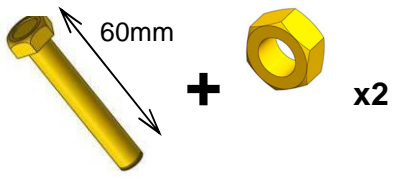

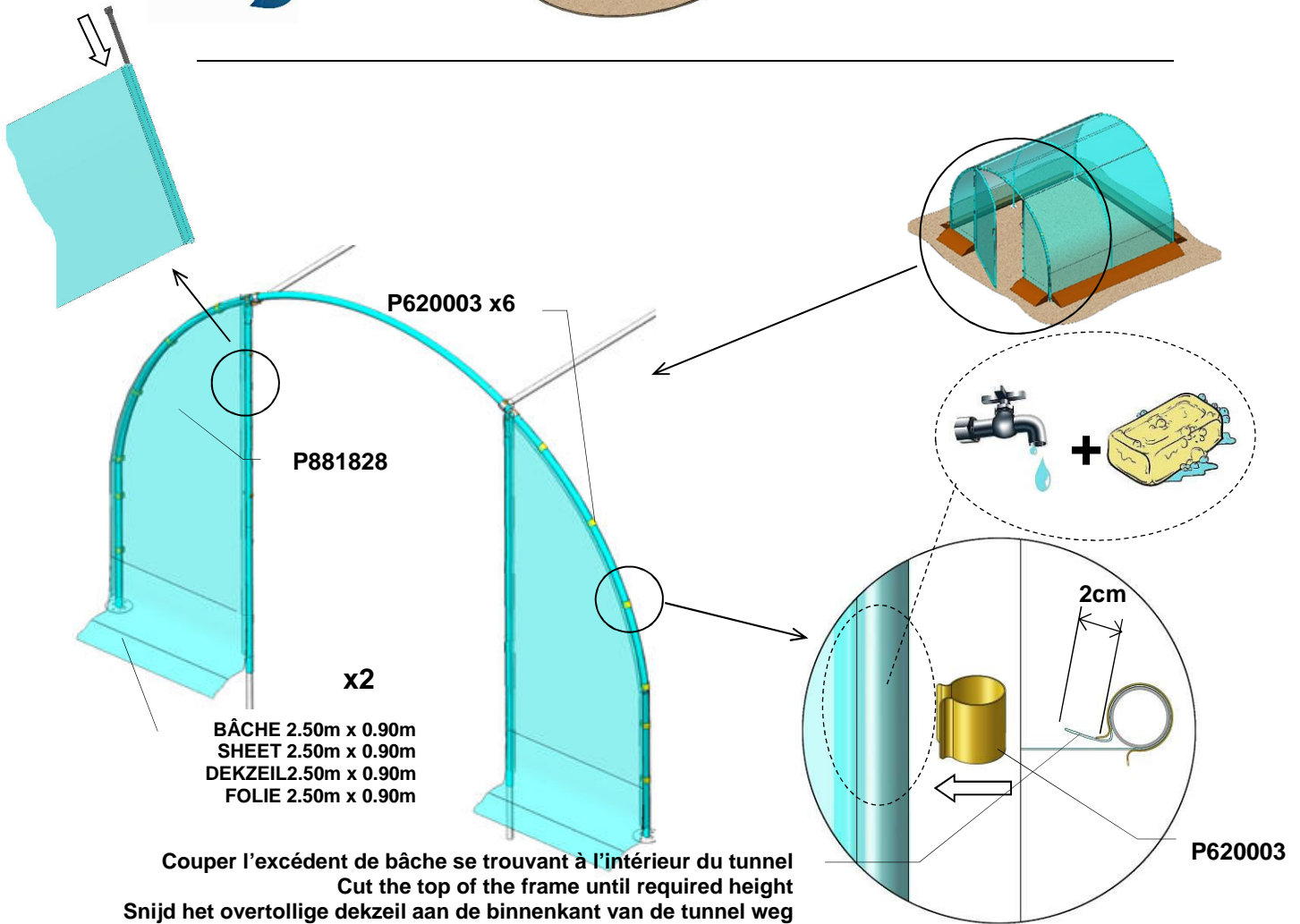
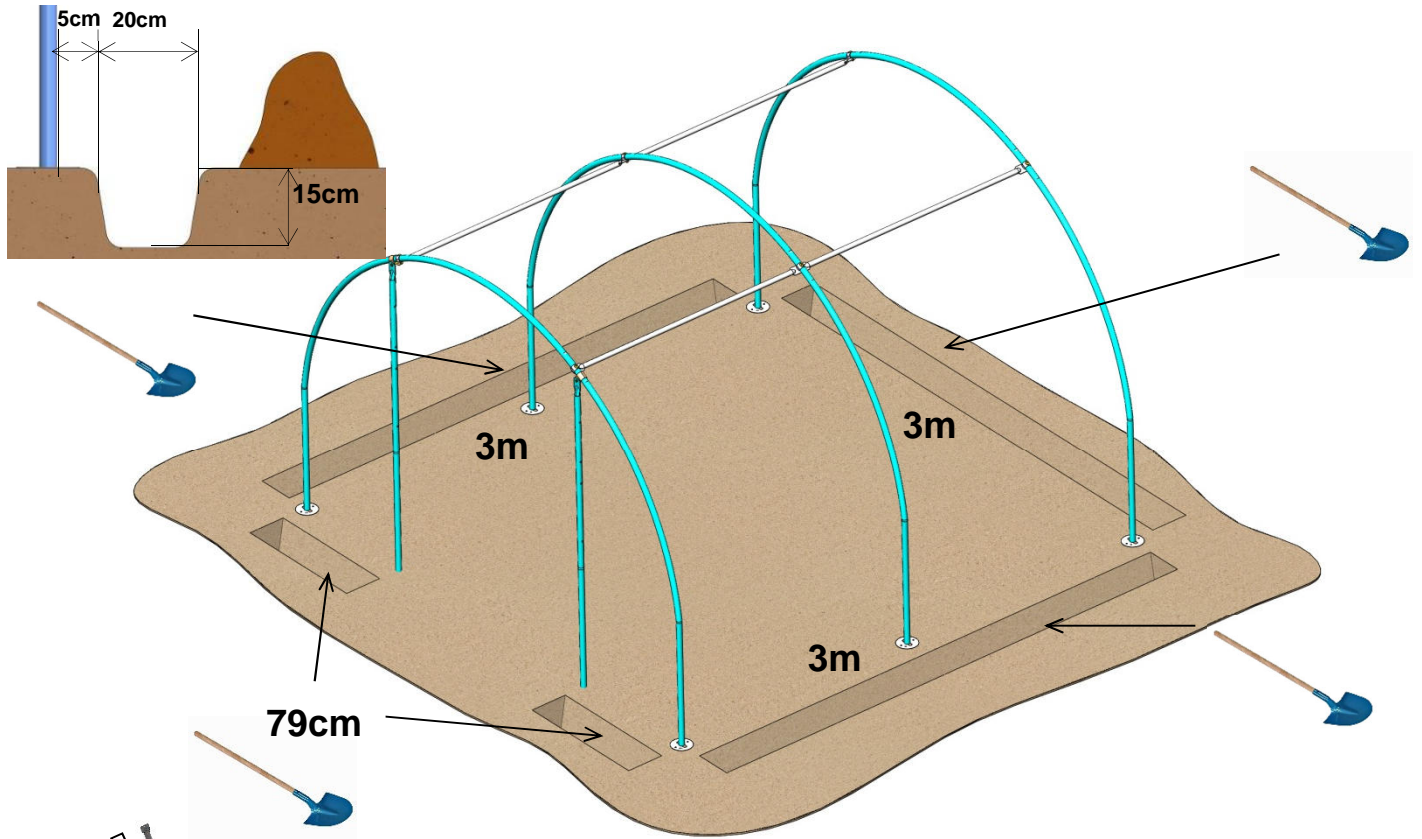

Couper l'excédent de bâche se trouvant à l'intérieur du tunnel
 Cut the top of the frame until required height
 Snijd het overtollige dekzeil aan de binnenkant van de tunnel weg
 Den oberen Teil des Rahmens an gewünschter Höhe durchtrennen

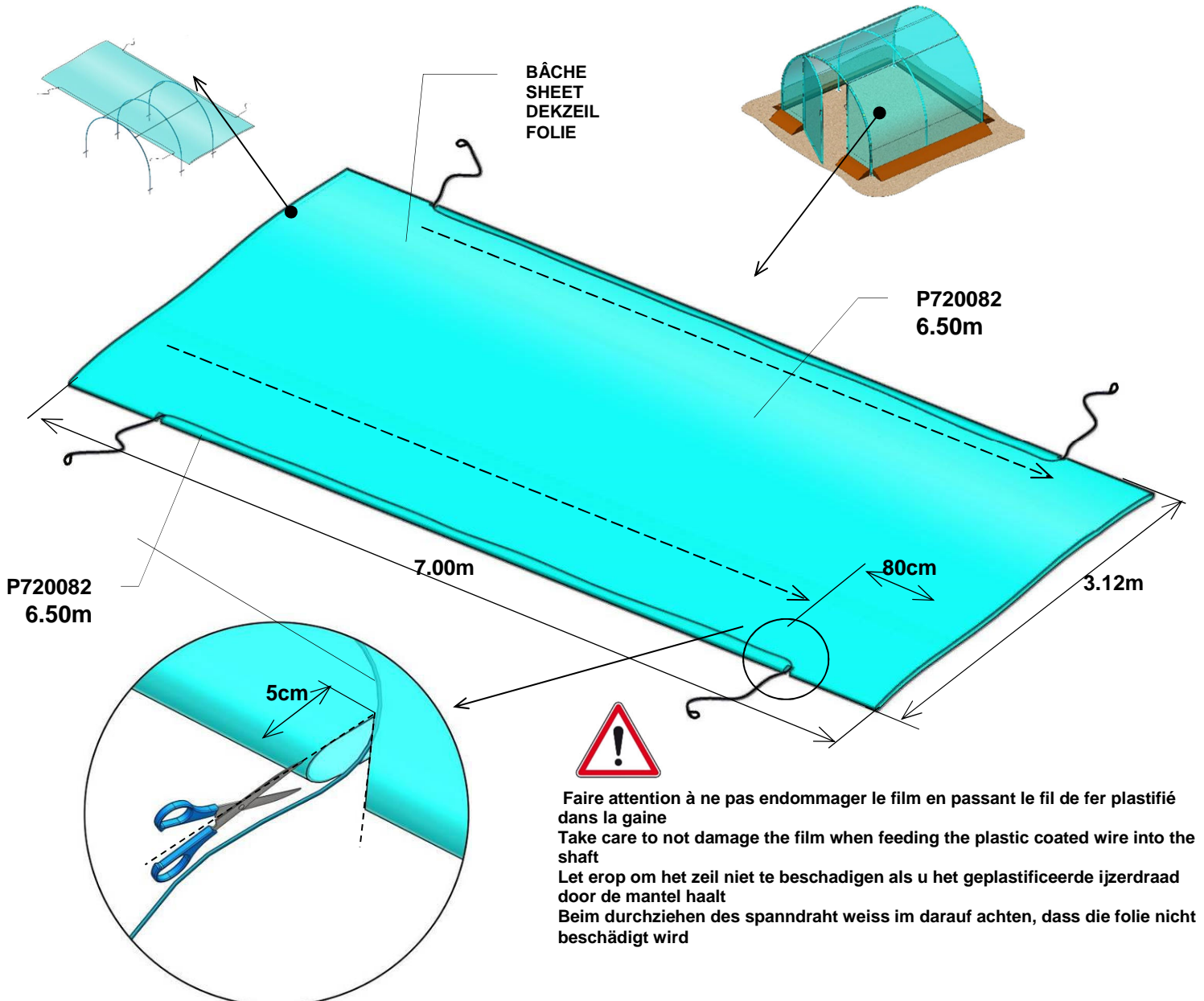
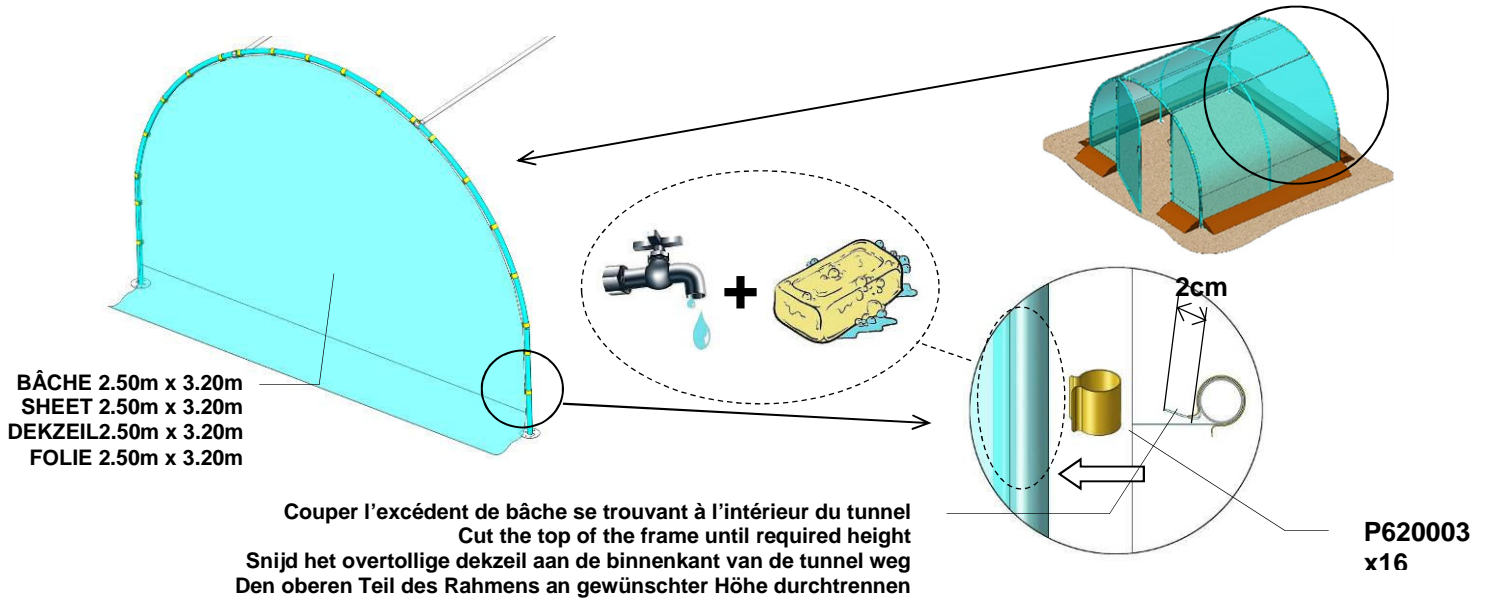

BÂCHE
SHEET
DEKZEIL
FOLIE

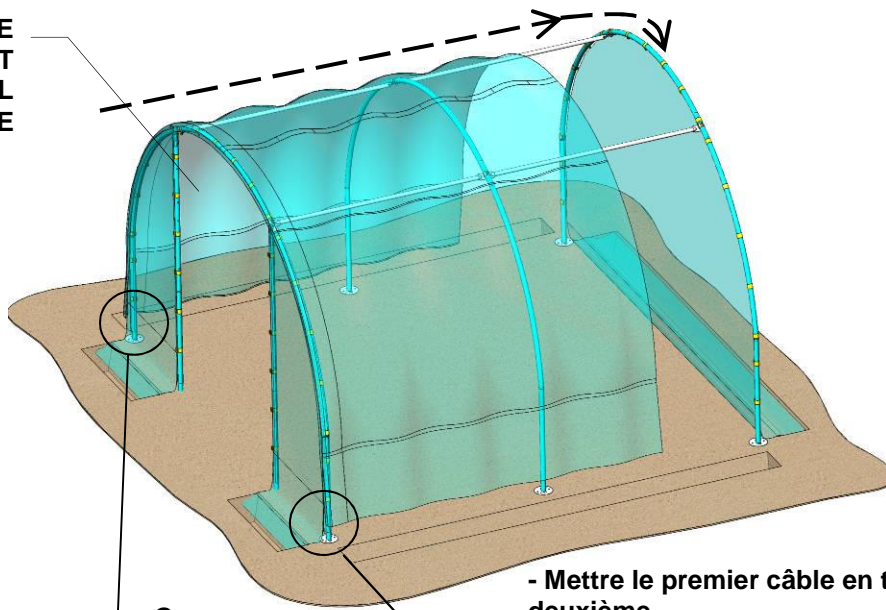

- Mettre le premier câble en tension avant la mise en place du deuxième
- Tight the first cable before putting in place the second
- Trek de eerste kabel strak voordat u de tweede plaatst
- Spannen des ersten Kabels bevor das zweite angebracht wird

2

P730001

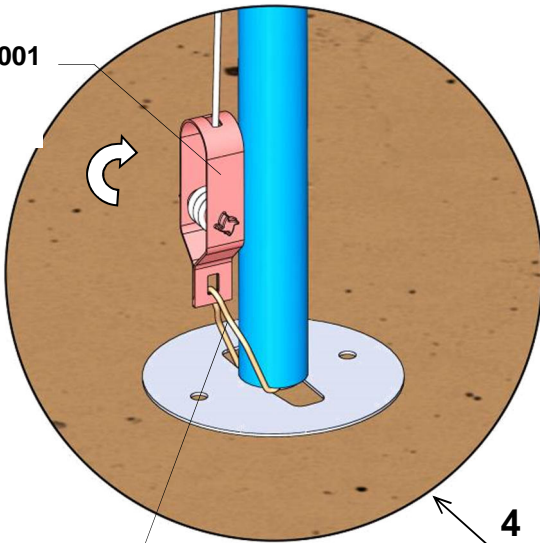

P720013

1

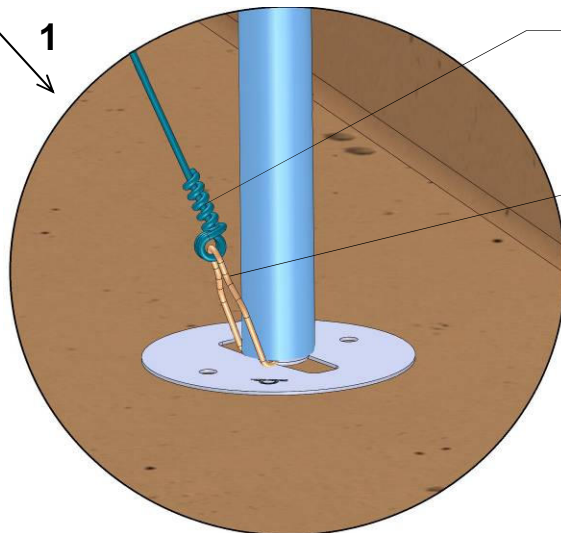

P720082
6.50m

P720013

4

3

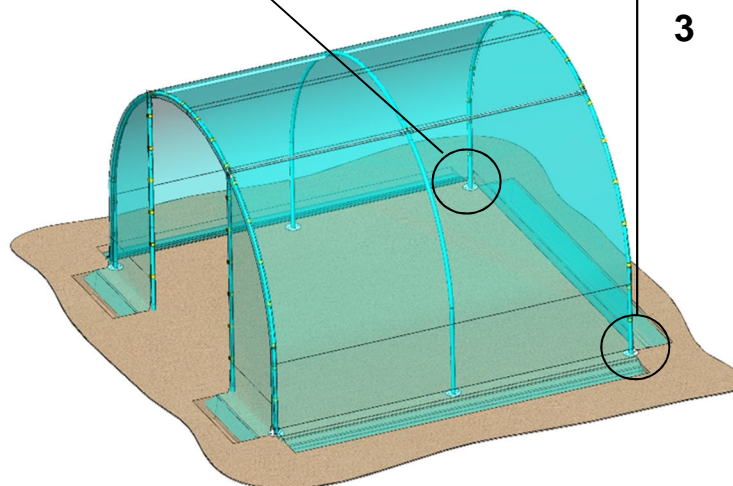

**AMARRAGE
ANCHORING
BEVESTIGING
VERANKERUNG**

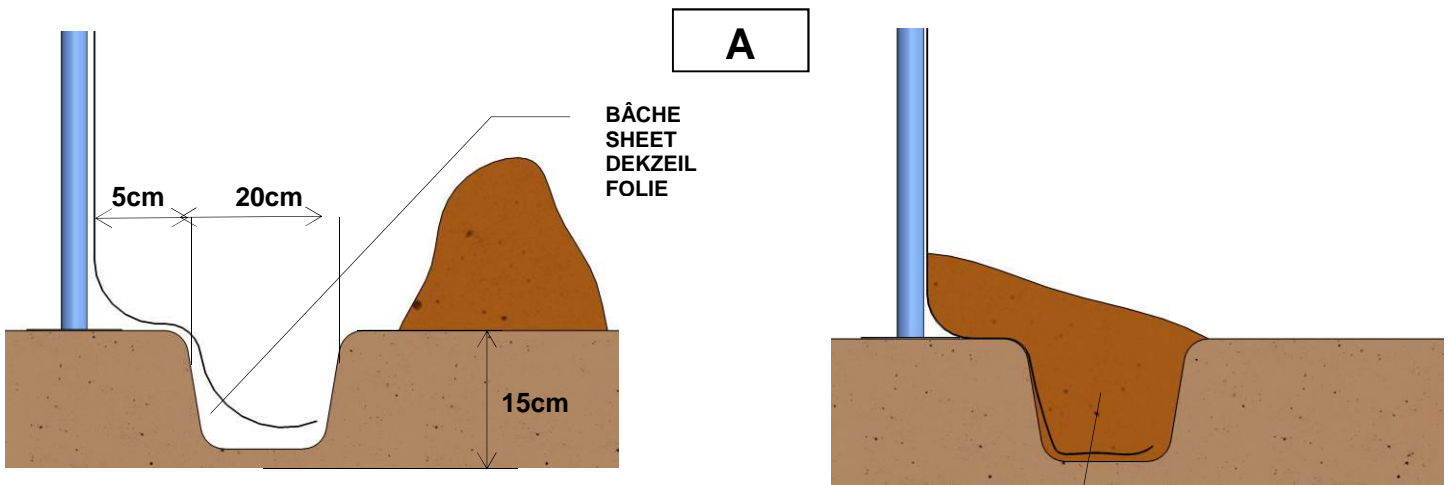
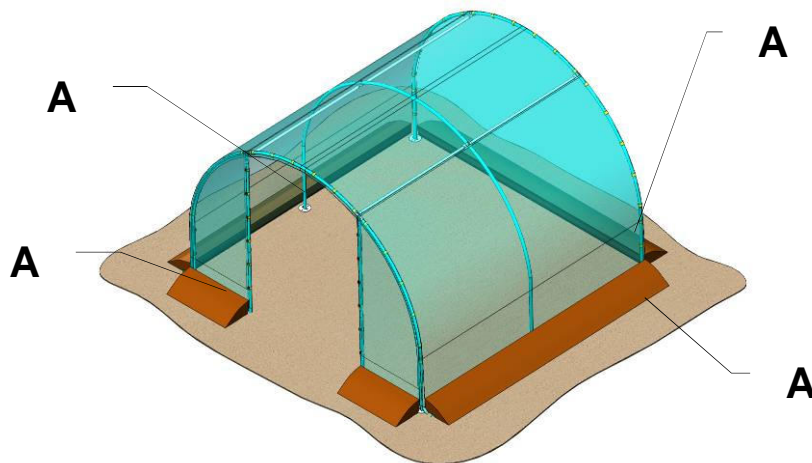

- REMBLAI : ASSURE L'AMARRAGE DE LA SERRE AU SOL
- IN-FILL : ENSURE ATTACHMENT OF THE GREENHOUSE TO THE GROUND
- OPVULLING: VERZEKERT DE BEVESTIGING VAN DE KAS AAN DE GROND
- AUF SCHÜTTUNG : GEWÄHRLEISTET DIE VERANKERUNG DES GEWÄCHSHAUSES AM BODEN

Le film doit être parfaitement tendu à la pose et le demeurer, par des vérifications complémentaires régulières, quelles que soient les conditions climatiques extérieures.

En cas de chute de neige, la serre doit être entièrement déneigée.

RESISTANCE AUX PRODUITS CHIMIQUES :

Certains produits chimiques peuvent affecter la résistance au vieillissement des films (produits organo-chlorés, phosphorés, carbamates soufrés, etc.) ; en particulier, certains produits de traitement des cultures, à base de soufre, attaquent les systèmes de stabilisation des films incolores et blancs.

Dans toute la mesure du possible, on évitera les contacts prolongés entre ces produits et les films.

The film must be correctly tightened on installation and stay that way, with regular checks, whatever the weather conditions.

In the event of snowfall, the greenhouse must be completely cleared of snow.

RESISTANCE TO CHEMICALS :

Certain chemicals can adversely affect the film and reduce its life expectancy (organic chlorides, phosphates, sulphur carbonates, etc.); in particular certain sulphur based crop treatments attack the stabilisers in clear or white films.

As much as possible prolonged contact between these products and the film should be avoided.

Het zeil moet perfect strak worden getrokken. De spanning van het zeil moet regelmatig worden gecontroleerd, ongeacht de weersomstandigheden buiten.

In geval van sneeuwval moet de kas volledig worden ontsneeuwd.

BESTENDIGHEID TEGEN CHEMISCHE PRODUCTEN:

Sommige chemische producten kunnen de weerstand tegen veroudering van het zeil aantasten (organische producten met chloor of fosfor, zwavelurethanen, enz.); met name sommige producten voor de behandeling van gewassen, op basis van zwavel, tasten de stabilisatiesystemen van doorzichtige en witte zeilen aan.

Vermijd, voor zover mogelijk, langdurig contact van deze producten met het zeil.

Die Folie muss bei der Anbringung einwandfrei gespannt werden und so verbleiben. Durch regelmässige zusätzliche Überprüfungen, wie auch immer die äusseren klimatischen Bedingungen aussehen mögen, ist der Sitz der Folie zu überprüfen.

Bei Schneefall ist das Gewächshaus vollständig von Schnee zu befreien.

RESISTENZ GEGENÜBER CHEMISCHEN PRODUKTEN :

Einige chemische Produkte können die Alterungsresistenz der Folien beeinflussen (Organo-chlorierte, phosphorierte, Karbamat- geschwefelte Produkte, usw.) ; insbesondere bestimmte Produkte zur Behandlung der angepflanzten Kulturen auf Schwefelbasis können das Stabilisierungssystem der farblosen und weissen Folien angreifen.

So weit es nur geht sollte der verlängerte Kontakt zwischen diesen Produkten und der Folie vermieden werden.

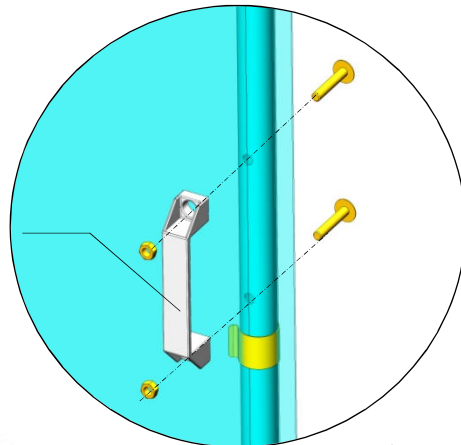
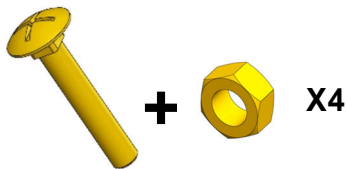

P620717

BÂCHE 2.50m x 1.50m
SHEET 2.50m x 1.50m
DEKZEIL 2.50m x 1.50m
FOLIE 2.50m x 1.50m

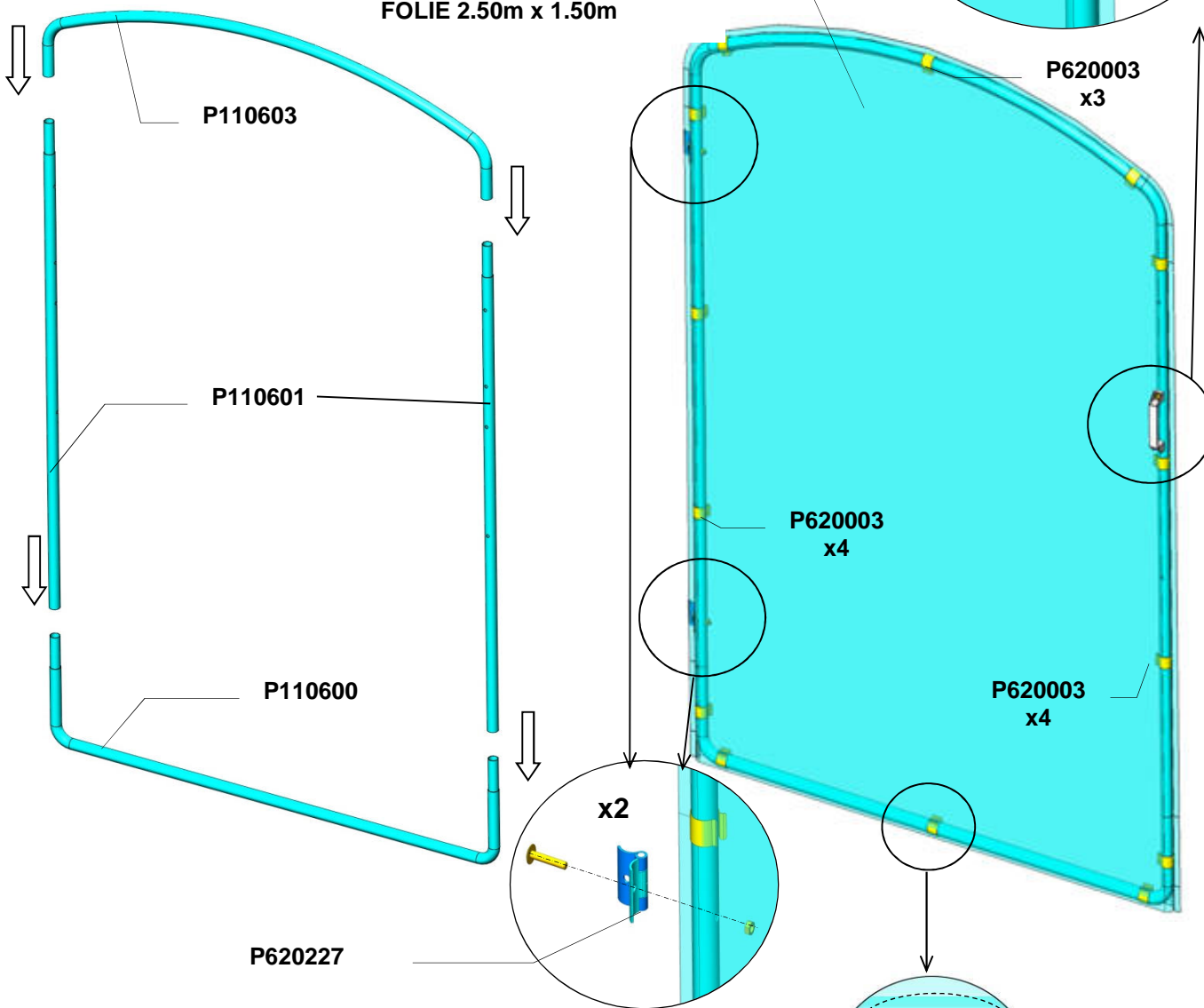

- 1)
 -Présentez la porte à sa place et repérez les emplacements des charnières
 -Bring the door into position and locate the position of the hinges
 -Zet de deur op zijn plaats en markeer de plaatsen voor de scharnieren
 -Bringen sie die tur in position und markieren sie die stellen fur die scharniere

- 2)
 -Découpez la bâche délicatement au cutter et positionner les charnières
 -Delicately cut out the sheeting using a stanley knife and position the hinges
 -Snijd het dekzeil voorzichtig uit met een cutter en plaats de scharnieren
 -Scheiden sie die folie mit hilfe eines cutters aus und bringen sie die scharniere in die richtige

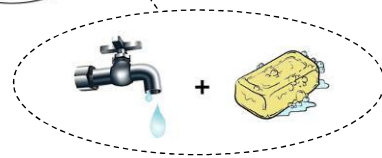
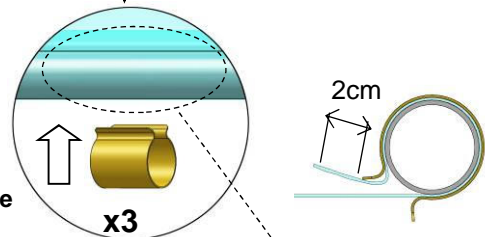

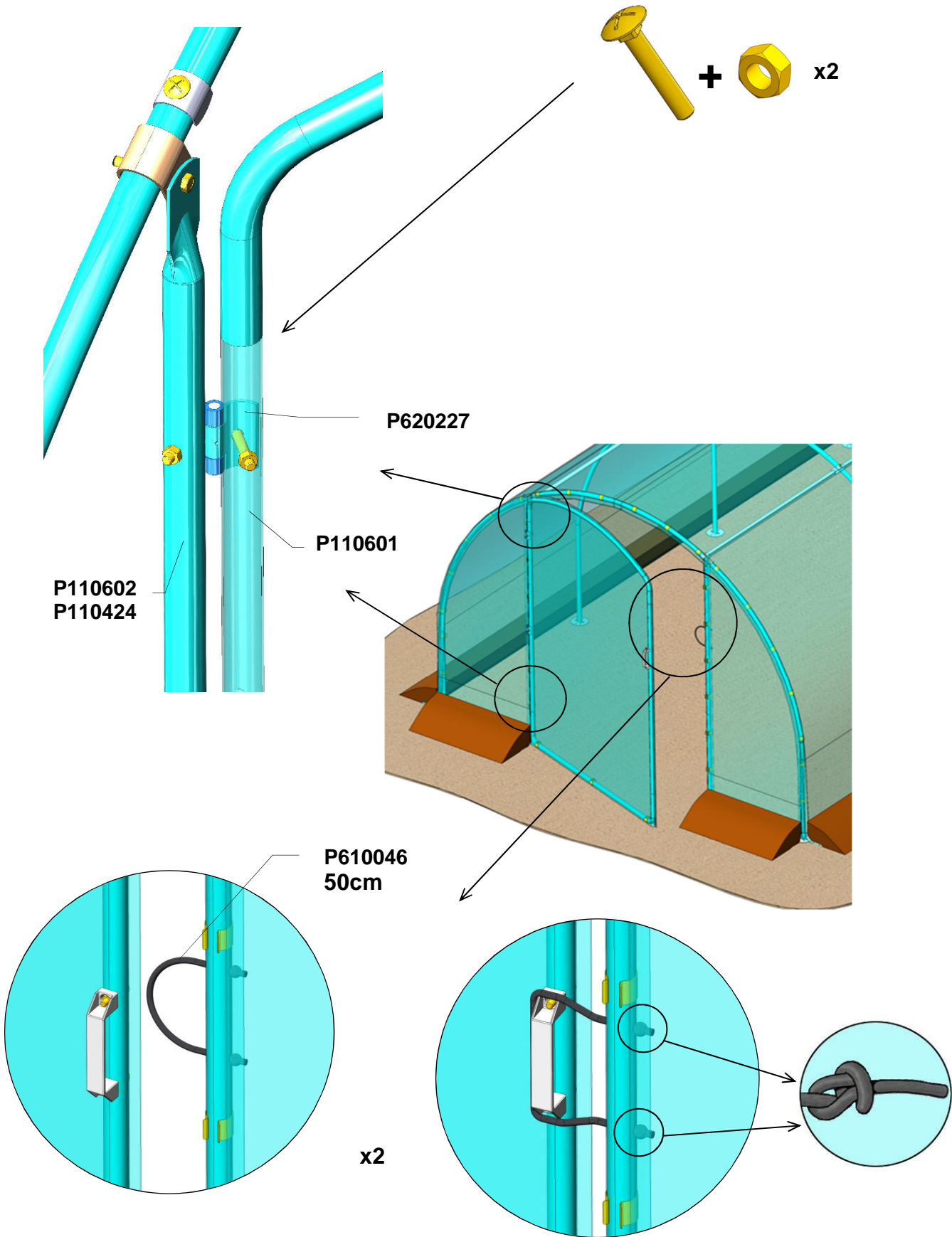

C6690 · COLIS POUR J30309-SERRE 3x3-2016		
P110598	CINTRE D32x1,5 LG1460 SDJ - 3m	x9
P240062	RENFORT 27AC15 L 1500	x4
P110542	RALLONGE D32 Lg 850 SERRE 2m	x6
P110424	TUBE D32 LG0m99	x2
P110602	1/2 RENFORT 32AC15 LG1130 PER	x2
P110603	HAUT DE PORTE SDJ 3m	x1
P110600	BAS DE PORTE - D32x1,5 - 1420x350R	x1
P110601	TUBE D32x1,5 LG1460 R	x2
P881817	GAINÉ PE 3m12 LG7000	x1
P881809	PE PIGNON PLEIN T3M	X1
P881828	HABILLAGE PIGNON LATERAL SDJ 3m	x2
P881815	PE PIGNON PORTE +2m	x1
C6741	COLIS VISSERIE POUR J30309-2016	x1

C6741 · COLIS VISSERIE POUR J30309-2016		
P620003	CLIPS ACIER 3 cm	X50
P730001	TENDEUR COLIGNON	x2
P730182	POIGNEE PLASTIQUE 150-N-CH	x1
P610046	SANDOW LG 1m50	x1
P720082	FIL DE FER PLASTIFIE LG 14m	x1
P710193	COLIS 6 BOULONS POELIER 8*50	x2
P620227	CHARNIERE RIVETEE	x2
P720013	CROCHET LIGATURE D 32	x4
P250005	TUBE D27x2 LG200 PER	x6
P620842	RONDELLE FINITION D32 - 30x30	x6
P620717	PIED PLATINE SERRE DE JARDIN	x6
P620724	FER A BETON DIA 8 HA LG 500	x6
P410007	CAVALIER U 33.7	x2
P710006	VIS 8x60	x2
P710010	ECROU H8	x2

**FICHE DE COMMUNICATION - COMPLAINT SHEET - KLACHTENFORMULIER -
REKLAMATIONSFORMULAR**

