

TOTEM™

Solar Urban Light

SOLAR PATHWAY LIGHT

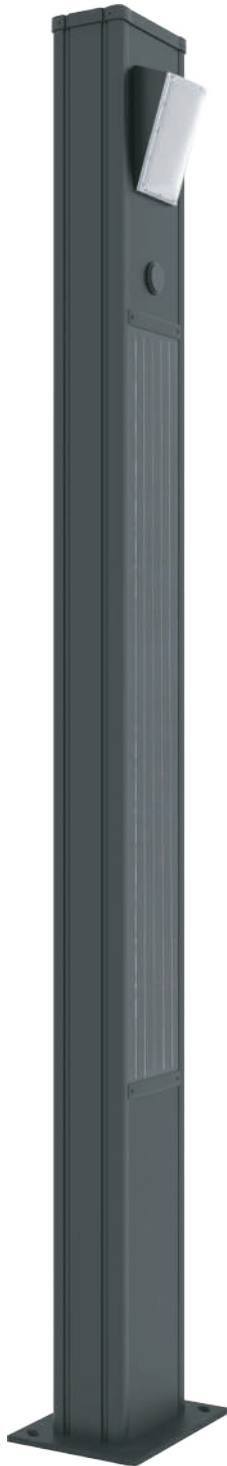

Our Totem Solar Urban Light features a smart and unique design with built-in solar panels for a discreet integration in metropolitan environments. It is constructed with the best components available on the market, using LiFePo4 Batteries, MPPT controller with remote, and also made with aluminum. This makes it the most powerful and reliable solution for your lighting project.

- Economical, easy to install
- Philips LumiLEDs luxeon chips
- The light automatically switches on at dusk and switches off at dawn
- All in one built in solar panel, battery and LEDs
- Grade A Mono Crystalline solar cells to maximize solar energy and ensure fast charging
- Certified by CE and ROHS with LED chips that provide qualifying lighting and 50000+ hours lifespan with super bright illumination
- Smart power management for rainy days, automatic day and night detection
- 0 carbon dioxide emissions
- Lithium LifePo4 with lifetime over 10 years
- 150 Lumens per watt and IP65 rated
- 5 Years limited warranty in all components

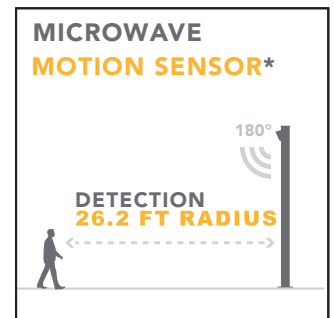
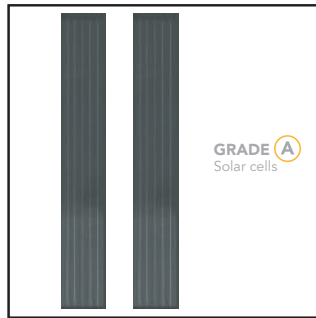

* Beyond Solar offers a Limited Warranty that the TOTEM Series luminaire shall be free from defects in material and workmanship. This limited warranty covers all components when installed and operated according to Beyond Solar instructions. Fixture suitable for ambient temperature from 14°F to 122°F. PV Panels - 20 year performance warranty Controller & Batteries : 1 years



TOTEM™

Solar Urban Light

LED POWER	20 WATT
LUMINOUS FLUX	3000 LUMENS
LIGHTING	
Efficiency	150 LUMENS / WATT
Chips	PHILIPS LUXEON
LED Lifetime	OVER 50000 HOURS LM80
Lighting Angle	160 DEGREE
Light Height	8.85827 FT
STORAGE	
Technology	LITHIUM IRON PHOSPHATE LIFEPO4 - 26650
Capacity	27 AH 12.8 VOLTS
Autonomy	OVER 24 HOURS AT FULL CHARGE - 4 RAINY DAYS BACK UP
Charging time	6-7 HOURS
Lifespan	OVER 4000 CYCLES @ 80% DOD OVER 10 YEARS LIFETIME
Working Temp.	14°F to 158°F
ENERGY	
Solar panel	115 WATTS /18V
Cells type	MONOCRYSTALLINE PANEL GRADE A 25 YEARS
Certificates	IEC 61215 ; IEC 61730 I AND II ; IEC 60904
ELECTRONIC	
Controller	MPPT SMART CONTROLLER (REMOTE MONITORING OPTIONAL)
Sensor	MICROWAVE 360 DEGREE MOTION SENSOR
Cabling	WATERPROOF CONNECTOR, PLUG AND PLAY
Protection	OVER LOAD/CURRENT/TEMP°/VOLTAGE/CHARGE/DISCHARGE
Certificates	EN 55015 ; EN 61000
MECHANICAL	
EPA (m2/ ft2)	0,428 / 4,6
Wind Load Rate	111.847 MPH
Base plate	11.811 X 7.87402 IN
DIMENSIONS	
Unit size L x W x H	106.2992 X 16.9291 X 14.9606 IN
Carton size	107.0866 X 18.1102 X 16.1417 IN
Net weight	90.3895 LB
Gross weight	103.617 LB
QTY per container 20" / 40" / 40"HQ	50 / 100 / 120

SOLAR PATHWAY LIGHT



TOTEM™ Solar Urban Light

OVER
10
YEARS
LIFE SPAN

BATTERY LITHIUM LIFEPO4

The TOTEM Series is equipped with Iron Phosphate Lithium LiFePo4 battery. This technology is proved to be **the best chemical technology for solar** application on the market.

With a cycle life of **over 4000 Cycles @ 80% DOD**, the battery enjoys **over 10 years lifetime**.

EASY MAINTENANCE & ANTI THEFT SCREWS



Easy and direct access to the battery casing for maintenance. The enclosure is sealed with **anti theft screws**, which request special tooling to unscrew.

ELECTRONIC PROTECTION BATTERY MANAGEMENT SYSTEM (BMS)



The electronic algorithm **protects the battery** from operating outside its safe area. Monitoring its state, calculating secondary data, reporting that data, controlling its environment, authenticating it and / or balancing it.

The BMS offers **MULTI PROTECTION** :

- OVER/UNDER LOAD
- OVER/UNDER CURRENT
- OVER/UNDER VOLTAGE
- OVER CHARGE & DISCHARGE
- TEMPERATURE MANAGEMENT

* EXTREME TEMPERATURE DOWN TO 14°F. ❄️

Standard Lithium LiFePo4 batteries enjoy a working temperature range from 14°F to 158°F. *



ALUMINUM WATERPROOF CASING

High temperatures **greatly affect the battery's lifetime**. This is why our batteries are encapsulated in an aluminum waterproof casing for **a perfect heat dissipation**.

SOLAR PANEL 125 WATTS

For best performance and Design TOTEM are equipped with **advance SHINGLED technology**. Offering a higher power per square meter but also :

LESS ENERGY LOSS DUE TO SHADING

POWER LOSS DUE TO SHADING

Conventional panel	- 40%
Beyond Solar panel	- 6%

BETTER RELIABILITY

Low busbar failures & **Better mechanical performance**

MORE ATTRACTIVE

Without any busbar and no visible circuitry, most people won't notice that TOTEM is solar powered. Which allows an even **better integration in his urban environment**.

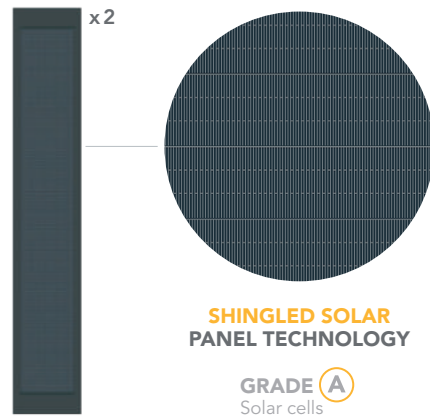

TOTEM™

Solar Urban Light

LUMINAIRE HOUSING & LEDS

20 WATTS - 3000 LUMENS - 5000K

An UV resistant thick Polycarbonate Fixture over a die-cast low-copper aluminum base. Protection class (IP66). It provides an excellent salt and humidity resistance as well as ultra violet resistance for color retention.

Our Luminaire is equipped with **PHILIPS LUXEON** High efficiency Chips offering and overall **150 Lumens per Watt efficacy**.

Our Luminaire comes with heat dissipation design, pure aluminum lamp base with sealed lens for **an optimal lighting and life Span**.

▶ LIGHT SOURCE **3030** | LED QTY (PCS) **48** | LENSE MEME STYLE (PCS) **4** | CRI > **70**

AVERAGE BEAM ANGLE (50%) : 106,2 DEG

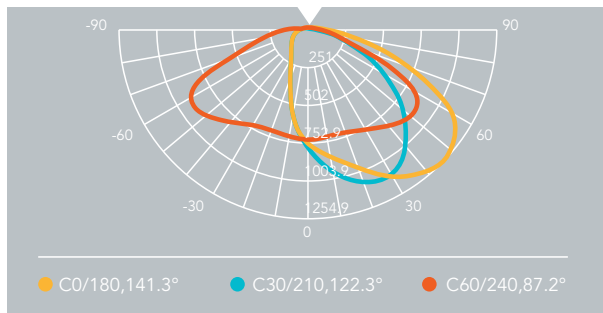

IP₆₆



CONTROLLER SMART MPPT

TOTEM is equipped with High Quality MPPT Controller, using **top technology semiconductor**.

FEATURES

HIGH TRANSFER EFFICIENCY

Charging efficiency up to 98%

MINIMAL STAND-BY POWER CONSUMPTION

Current consumption ≤ **10mA**

INTELLIGENT BATTERY MANAGEMENT 3 Phases charging :

MPPTT Charge / Constant Voltage /Floating Voltage.

INTELLIGENT LED DRIVER

Auto detecting of Dusk and Dawn for automatic operation, 7 Lighting Programs Configuration.

ANTI BLACK OUT : Load adjust according to battery capacity assuring all night long lighting in any weather conditions.

BATTERY & SYSTEM PROTECTION :

- OVER / UNDER LOAD
- OVER / UNDER CURRENT
- OVER / UNDER VOLTAGE
- OVER CHARGE & DISCHARGE
- TEMPERATURE MANAGEMENT

IP₆₈

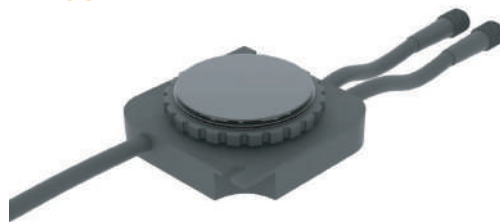

REMOTE CONTROL MONITORING

- Check the state of the battery
- Check the charging history
- Settle different running time slots
- Issue diagnostic

SOLAR PATHWAY LIGHT



TOTEM™ Solar Urban Light

OPERATION MODE

THE PHOTOSENSOR WILL AUTOMATICALLY SWITCH ON & OFF THE LIGHT FROM DUSK TO DAWN.

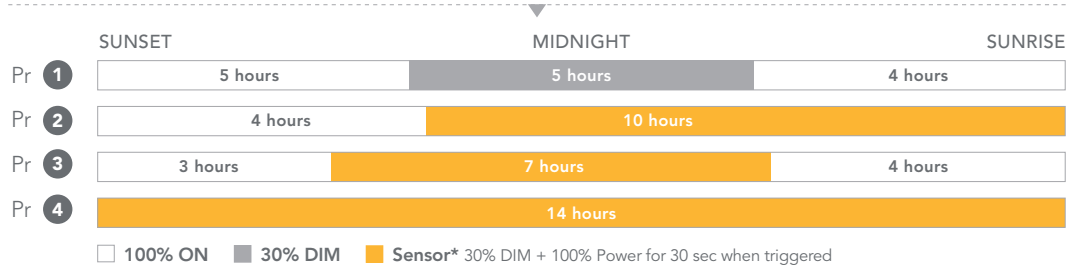

MICROWAVE MOTION SENSOR*

180° coverage, invisible and integrated to the luminaire housing.
26.2 FT wave radius.

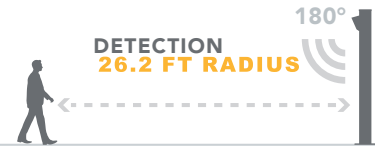

+ OPTIONAL

REMOTE MONITORING BEYOND SOLAR BRIDGE

The Beyond Solar team is proud to have developed a special tool for remote monitoring of our solar street lights. Beyond Solar Bridge uses low frequency technology LORA or ZIGBEE to monitor in real time a batch of solar street lights.

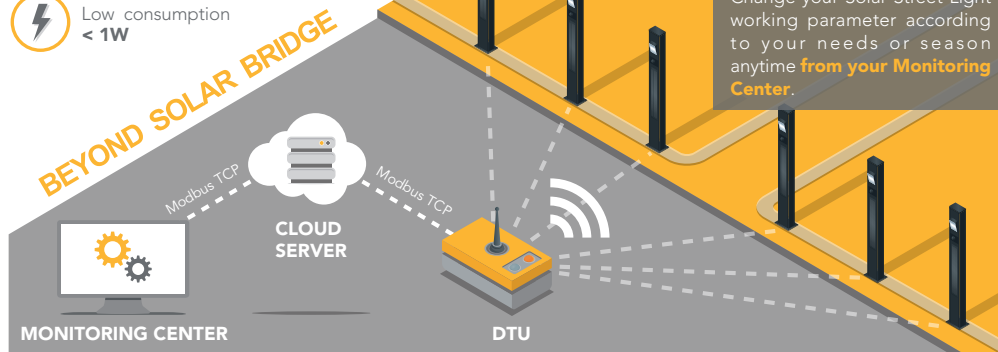

GLOBAL MANAGEMENT

Run diagnosis remotely from the Monitoring Center and get real time informations of all of your connected Solar Street Light on your computer screen.

FAULT ALARM

Be informed in case of Lamp failure, charging failure, controller short circuit, open circuit alarm, battery discharge with real time positioning for your maintenance.

REMOTE PARAMETER

Change your Solar Street Light working parameter according to your needs or season anytime from your Monitoring Center.



TOTEM™

Solar Urban Light

SOLAR PANEL & LUMINAIRE DIMENSIONS*

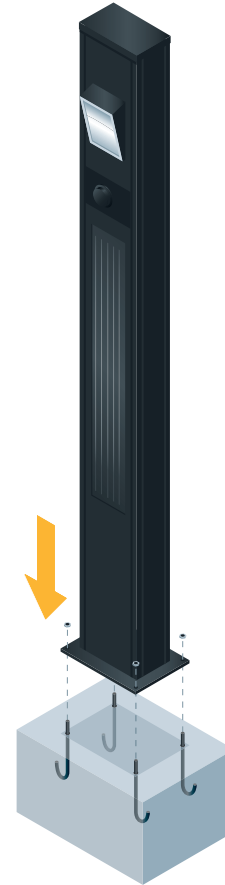
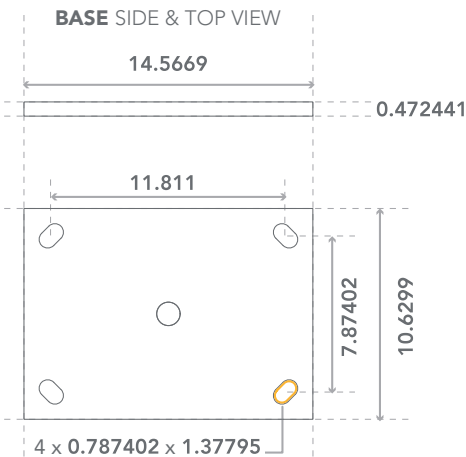
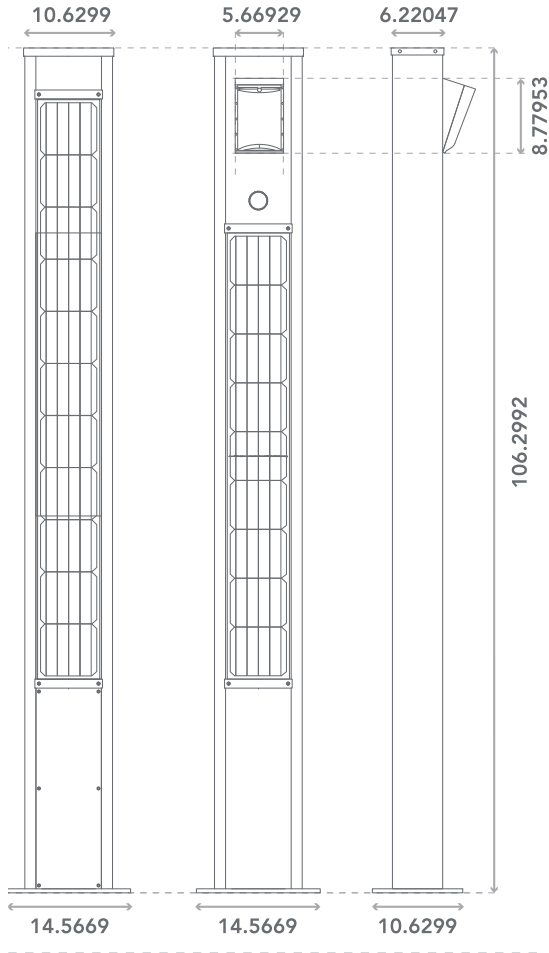

EASY INSTALLATION JUST FIX ON YOUR BASE

TOTEM comes in one piece which makes it extremely easy to install once out of the box.

You just need to **insert the base over the anchor** on your concrete basement and fasten bolts.

*All dimensions are in inches.

SOLAR PATHWAY LIGHT



TOTEM™ Solar Urban Light

TOTEM SOLAR LIGHT ASSEMBLY INSTRUCTIONS*

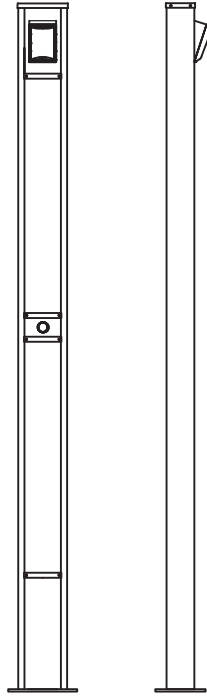

STEP 1:
Open the maintenance gate with provided tool

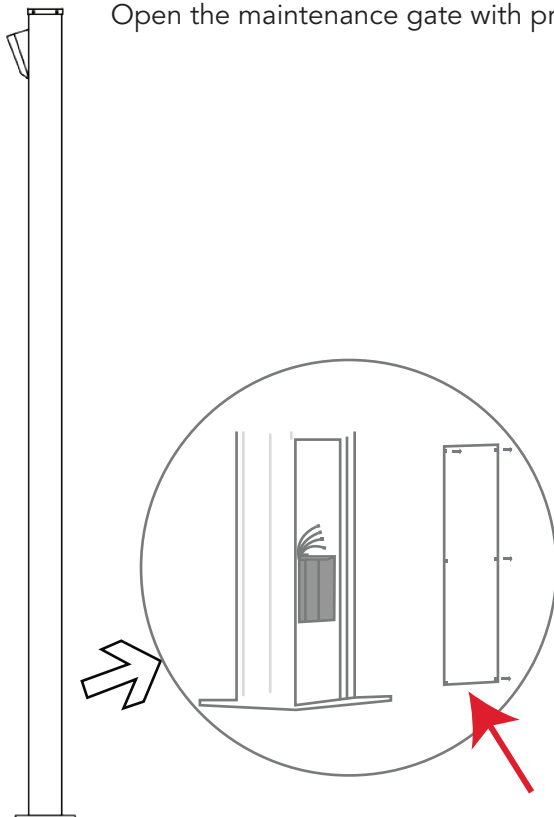

6 ANTI THEFT SCREWS

STEP 2:
Connect the plug & play connectors
"Male" to "Female".

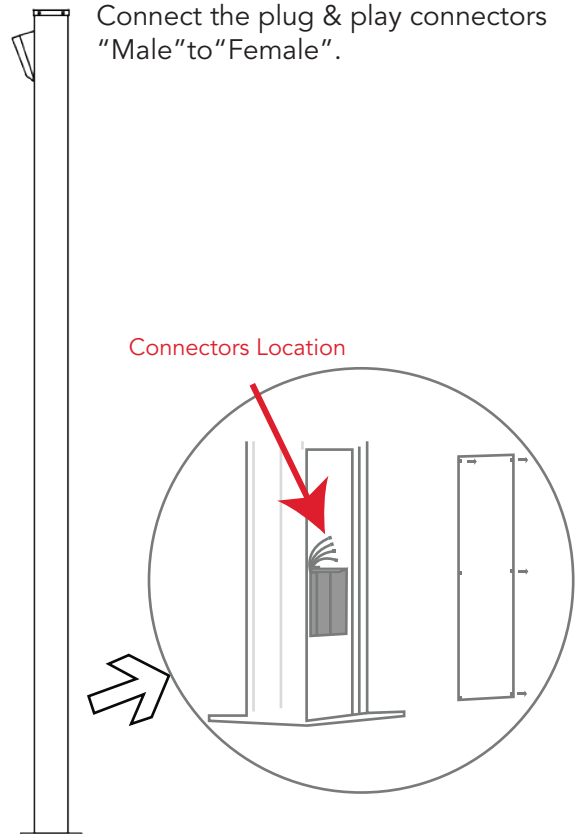

TOTEM™

Solar Urban Light

STEP 3:

First of all, you need to check the controller battery indicator red light shall be on with in steady state.

The second, you need to check the controller PV indicator red light shall be on with in blinking state

The third, you need to check the sensor's indicator blue light shall be blinking on the product

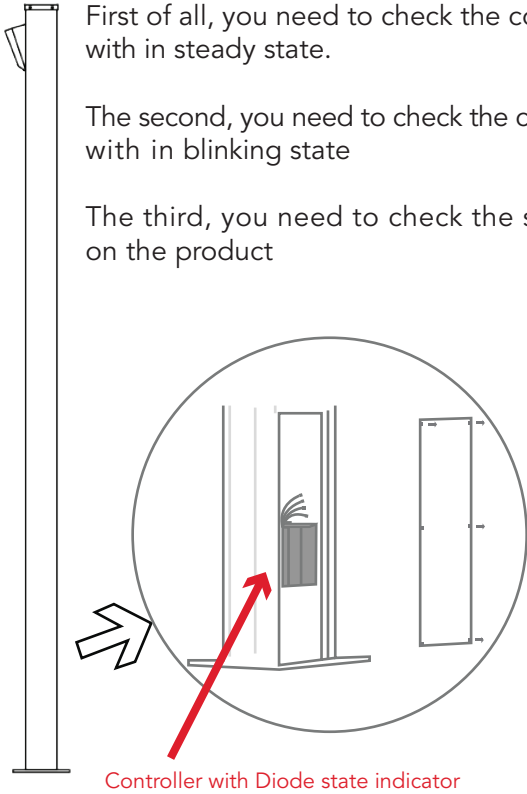

STEP 4:

Complete the above steps, please close the maintenance gate with screws.

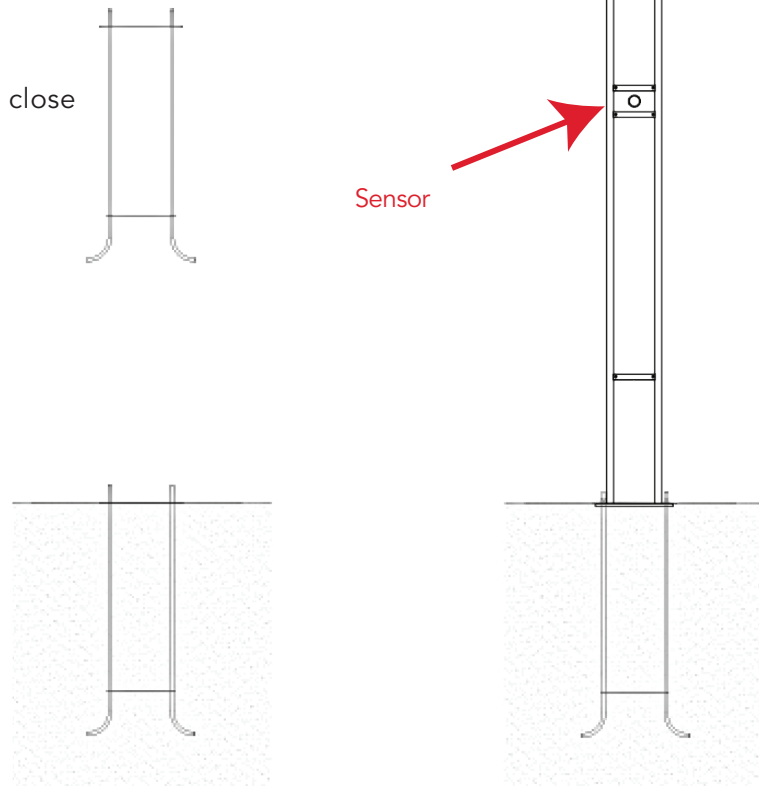

TOTEM™

Solar Urban Light

SOLAR PATHWAY LIGHT



TOTEM™

Solar Urban Light



SOLAR PATHWAY LIGHT

