

RENEW™

Solar Wall Pack



The Renew Solar Wall Pack Flood Light is a reliable, top performing LED solution. It's made with high performance LEDs providing 1,080 lumens in a bright $\geq 4000K$ color temperature. Perfect for industrial and commercial use in warehouses, parking areas, walkways, loading or working areas and security lighting.

- IP65 Rated
- Compact System
- 100% Less Power Consumption
- Automatic Day & Night Detection
- Various Color Choices
- 10 - 12 Hour Battery Life
- SMD 2835 LED Chips
- Completely Solar Powered
- Replaceable Lithium-ion battery
- No monthly electric bills
- High performance lithium battery with a bigger capacity that brings a longer lifespan
- Uses the new generation SMD LED as a Light Source, with the features of high brightness, low light decay, and long life span
- No cost of transformers or meters to be added for electric service
- Scientific human induction design, a wide angle detection area improves body movement detection for wider coverage and longer distances
- Battery backup for cloudy or rainy days
- No power outages
- Anti-UV & the Optical Lens makes light even brighter
- No line voltage, trenching, or metering
- Easy to install and operate - less than 1 hour
- 2 Years limited warranty

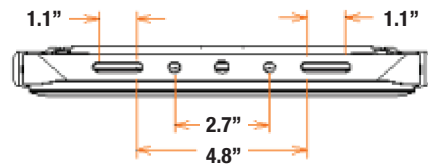
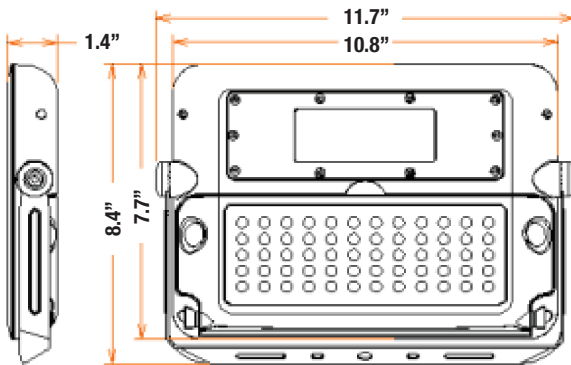

RENEW™

Solar Wall Pack

Specifications

Model #	SKU #	Power	PV Type	Solar Panel	Lithium Battery	Lumens	CCT	Sensor	Beam Angle	IP Rating
AVS-WP-10W-6K	790103	10W	MONO	6W	7200 mAh	1080 LM	6000K	PIR MOTION	180°	IP65
AVS-WP-10W-4K	790104	10W	MONO	6W	7200 mAh	1080 LM	4000K	PIR MOTION	180°	IP65

Features

- IP65 Rated
- Compact System
- 100% Less Power Consumption
- Automatic Day & Night Detection
- Various Color Choices
- 10 - 12 Hour Battery Life
- SMD 2835 LED Chips
- Completely Solar Powered
- Replaceable Lithium-ion battery



Applications

- Walls, Fences & Gates
- School Playgrounds & Gardens
- Streets, Roadways & Billboards
- Pathways, Sidewalks, & Ramps
- Campuses, Parks, & Yards
- Boat & Loading Docks
- Farm & Ranch Lighting
- Remote & Wildlife Areas
- Parking Lots & Military Bases

Advantages

- No monthly electric bills
- High performance lithium battery with a bigger capacity that brings a longer lifespan
- Uses the new generation SMD LED as a Light Source, with the features of high brightness, low light decay, and long life span
- Scientific human induction design, a wide angle detection area improves body movement detection for wider coverage and longer distances
- No cost of transformers or meters to be added for electric service
- Battery backup for cloudy or rainy days
- No power outages
- Anti-UV & the Optical Lens makes light even brighter
- No line voltage, trenching, or metering
- Easy to install and operate - less than 1 hour

SOLAR WALL PACK	
Model No.	AVS-WP-10W
Wattage	10 W
IP Rating	IP65
Operating Temp	5 to 113°F



RENEW™

Solar Wall Pack

Product Design and Benefits

- Global Patent Design, Light panel is flexibly folded, slim as a PAD.
- Solar panel and light panel are integrated flexibly, new leading in the whole industry!
- Bracket 360°adjustable, light panel 135°adjustable, fully realize your perspective of different lighting requirement.
- TWO sensors inductive, wider detection angle, higher sensitivity.
- Original created 360 degree IP65 waterproof.
- Adopt optical Lens optimize light, not only make the light more brighter, also Anti-UV.
- THREE working modes for different application in different seasons.
- High Quality mono-crystalline Silicon Solar Panel, High Conversion Solar Photo electricity, high energy trans-action rate.
- High performance lithium battery 7200mAh, bigger capacity brings longer lifespan.

Product Model	LD-SFL-10W-Leadpad	Overall Dimension	11.811*8.46457*1.37795"
Power	10W	Lumen	1080LM
Solar Panel	Mono-crystalline silicone	Battery	4PCS*1800mAH/3.7V 18650 Lithium battery
Charging Time	6Hrs/Day	Working Time	3 different lighting modes
LED Type	SMD 2835*60pcs	PIR sensor Range	Detection angle: 180° Detection area: ≤8M
Surface Color	Black	Beam angle	90°
IP Class	IP65	Working Temp	5°F to 113°F
Housing Material	ABS+PC	Warranty	24 months (battery warranty 12 months)



RENEW™

Solar Wall Pack

Adjustable Bracket

The mounting bracket can be adjusted 360 degrees.



Walk By, Lights On

The sensitive motion sensor detects motion. Even your little pets, like dogs, cats can active the solar light sensor.

Correlated Color Temperature

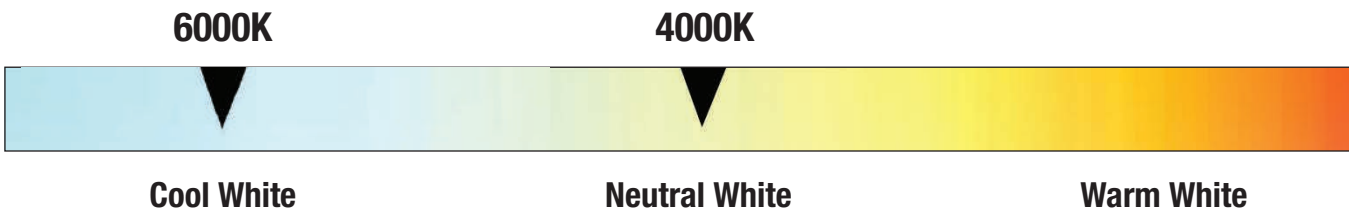

RENEW™

Solar Wall Pack

Operation

Light sensor + PIR motion sensor, please press the button to adjust working mode:

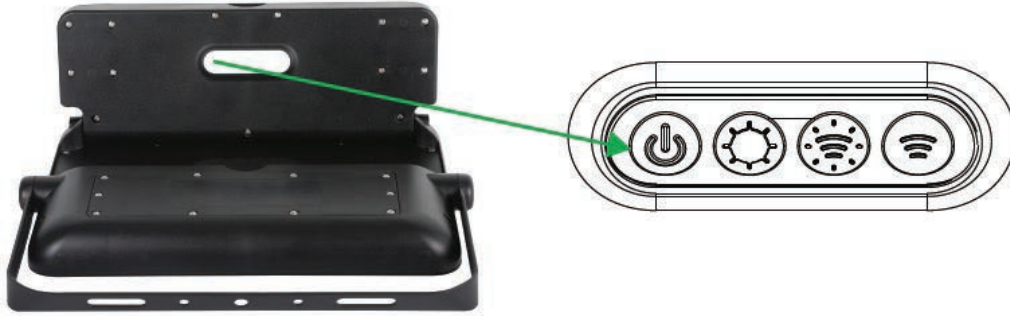

 On/Off



 Automatically turns on at the dusk and remains 20% brightness.



 Automatically turns on to full brightness (1080lm) when motion is detected in the range ≤8mtrs and then turns to 3% brightness in 20 seconds of no motion.



 Automatically turns on to full brightness (1080lm) when motion is detected in the range ≤8mtrs and then turns off in 30 seconds of no motion.



RENEW™

Solar Wall Pack

Operation



The 60 LED Design offers brilliant lighting for a wide area and strong illumination. It's more radiant than other similar solar lights on the market.

PHOTOMETRIC SPECIFICATIONS

Model No.	AVS-WP-10W
LED Type	SMD 2835
Luminous flux	1080 Lm
Correlated Color Temperature	4000K & 6000K
Beam Angle	90°
Detection Angle/Area	180° / 26.24'

3 Optional Lighting Modes

Choose the perfect mode according to your needs.

Mode A

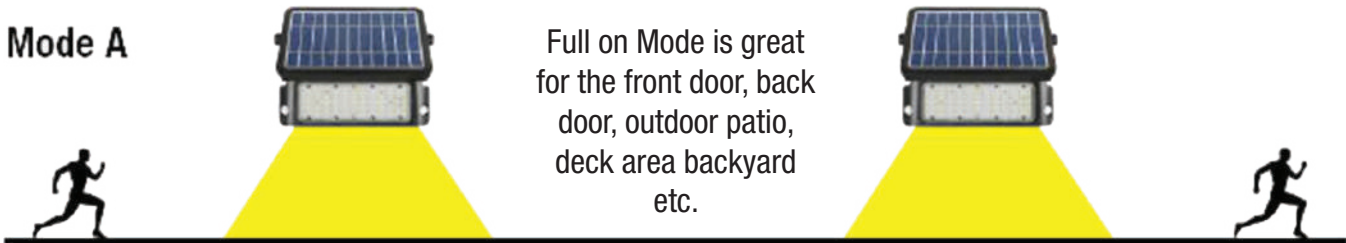

Full on Mode is great for the front door, back door, outdoor patio, deck area backyard etc.

Mode B

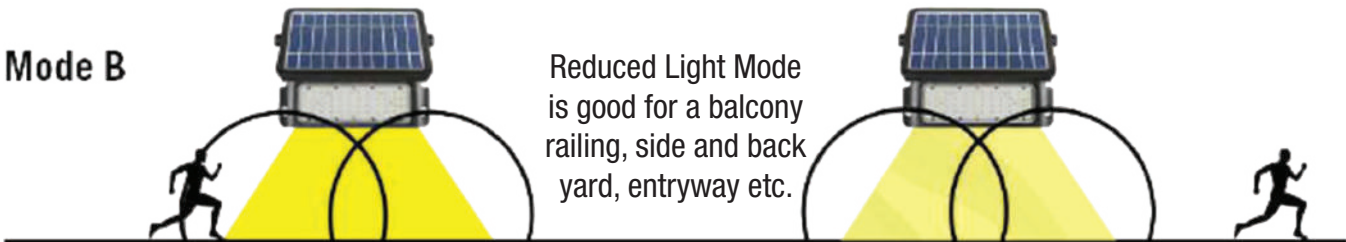

Reduced Light Mode is good for a balcony railing, side and back yard, entryway etc.

Mode C

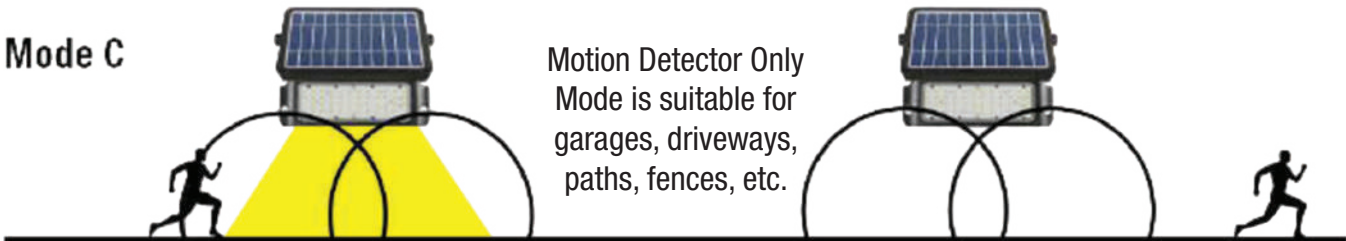

Motion Detector Only Mode is suitable for garages, driveways, paths, fences, etc.



RENEW™

Solar Wall Pack

Dimensions

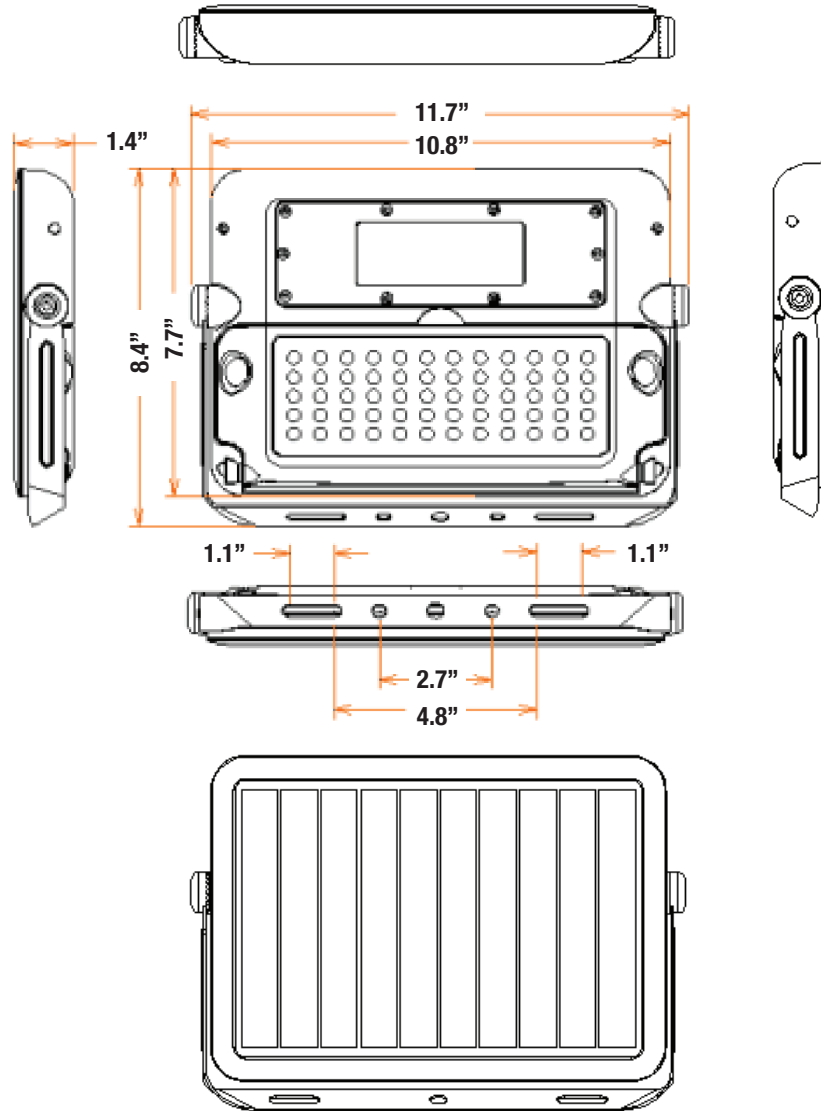

ELECTRICAL SPECIFICATIONS

Model No.	AVS-WP-10W	Wattage	10 W
Solar Panel	6 W	Cell of PV	Poly Crystalline Silicon
Battery Type	18650 Lithium-ion battery	Battery Capacity	3.7 V / 7200 mAh - Replaceable
Lifespan	35,000 Hours	Charging Time	10 Hours per Day
Discharging Time	>36 Hours	Working Time	3 Different Lighting Modes



RENEW™

Solar Wall Pack

Energy Saving

Absorb sunlight for a few hours in the daytime and it can stay lit throughout the night. The light lasts for 8 - 10 hours in steady mode if fully charged.



SOLAR WALL PACK

MECHANICAL SPECIFICATIONS

Model No.	AVS-WP-10W
IP Rating	IP65
Operating Temp	5 to 113°F
Product Weight	2.8 Lbs
Product Dimensions	11.8 x 1.4 x 8.5"
Packing Type	1 Set / Box
Packing Weight	3.5 Lbs
Packing Dimensions	22 x 2.57 x 9"

Easy To Install

Super easy to setup, just mount it where you need it, without the added expense and trouble of installing electrical wire. You can install it in any place that has direct sunshine.

Certified

- Suitable for wet locations
- DLC Premium qualified, eligible for rebates
- Lamp has been tested by UL authorized lab



RENEW™

Solar Wall Pack

Installation

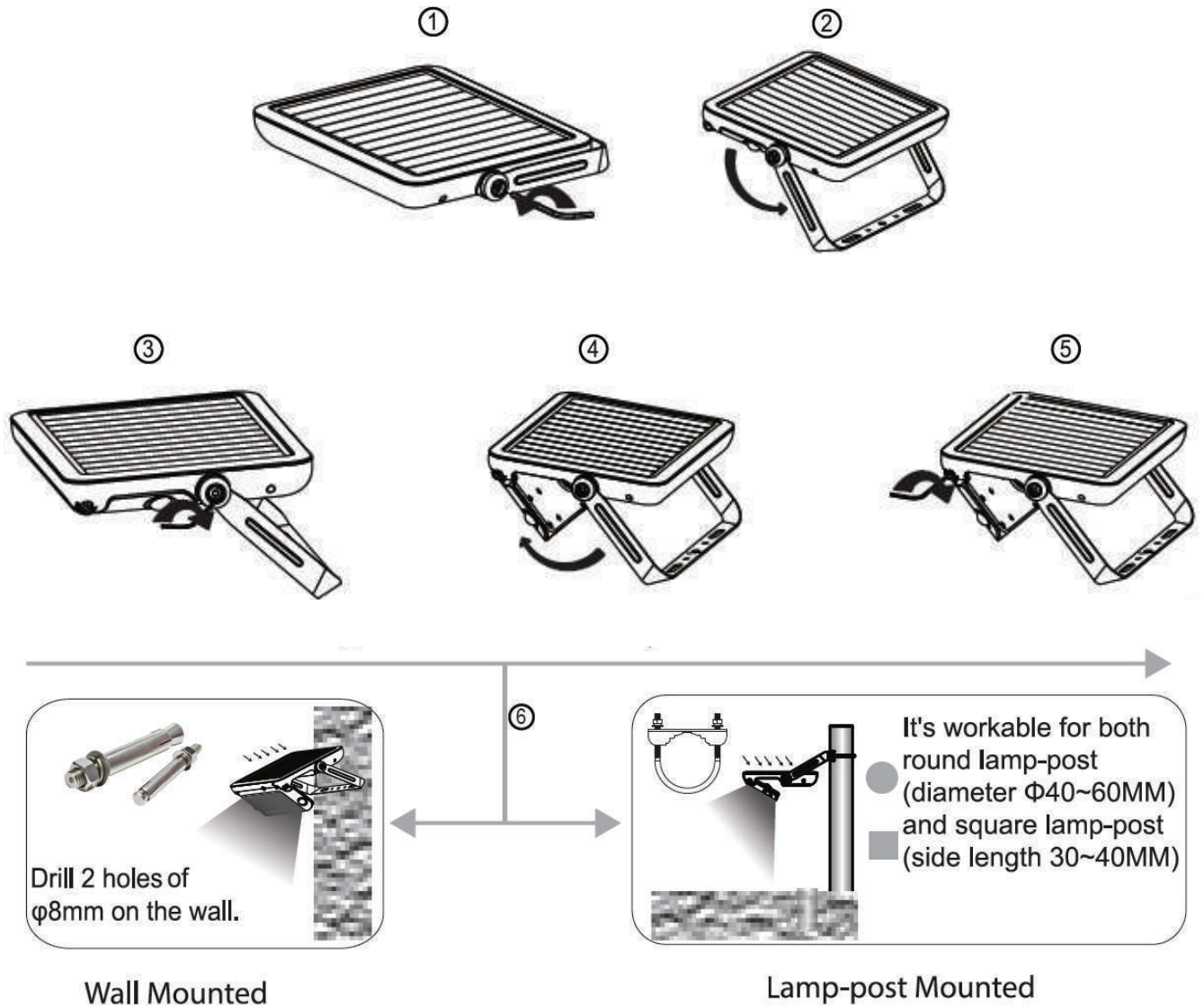

1. Prepare lamp, accessories and tools well firstly.
2. Use the allen wrench to loosen the bracket (see picture 1) , adjust it to the appropriate angle(see picture 2) and then fix the screw tightly(see picture 3).
3. Pull out the light panel and adjust it to your demanded lighting angle(see picture 4), and then fix the screw to tighten the light panel(see picture 5).
4. Fix the lamp onto the wall or lamp-post (see picture 6).



RENEW™

Solar Wall Pack

Notes

1. This is a solar powered lamp, please install it in a location where can get enough sunshine.
2. Please note the lighting time depends on sunshine duration & weather.
3. The lamp will light up automatically at dusk.
4. Recommended installation height is 3~4Mtr.
5. The lamp is equipped with an internal battery pack, which is replaceable.
If any need, please contact seller for correct new battery pack.
6. If the battery is taken out and put back in or replaced with new ones,
please toward the solar panel to sunshine or a strong light to activate the lamp.



RENEW™

Solar Wall Pack

Application

All the area inconvenient in electricity but full of sunshine, such as gardens, billboard, buildings, parking lot, entrance, courtyard, road, street, hotel etc.

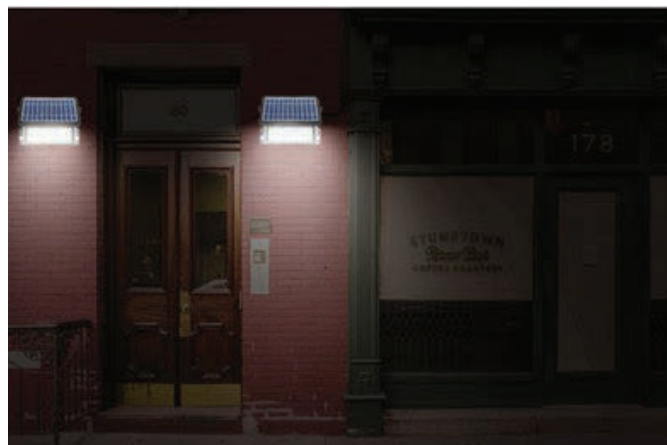

RENEW™

Solar Wall Pack

Application



SOLAR WALL PACK



RENEW™

Solar Wall Pack

Optimum Panel Orientation

The Solar charge in a battery pack won't last forever. The off-grid system relies on stored solar energy for autonomy. Angling your solar panels properly can boost the power intake of your solar lighting system. You want to angle your solar panels at a tilt based on the area's latitude.

Tip for Maximum Power

You can increase the tilt 15° in the winter or decrease 15° in the summer. In this way you can get the maximum sunlight to recharge the battery.

Best Facing Direction of Solar Panel

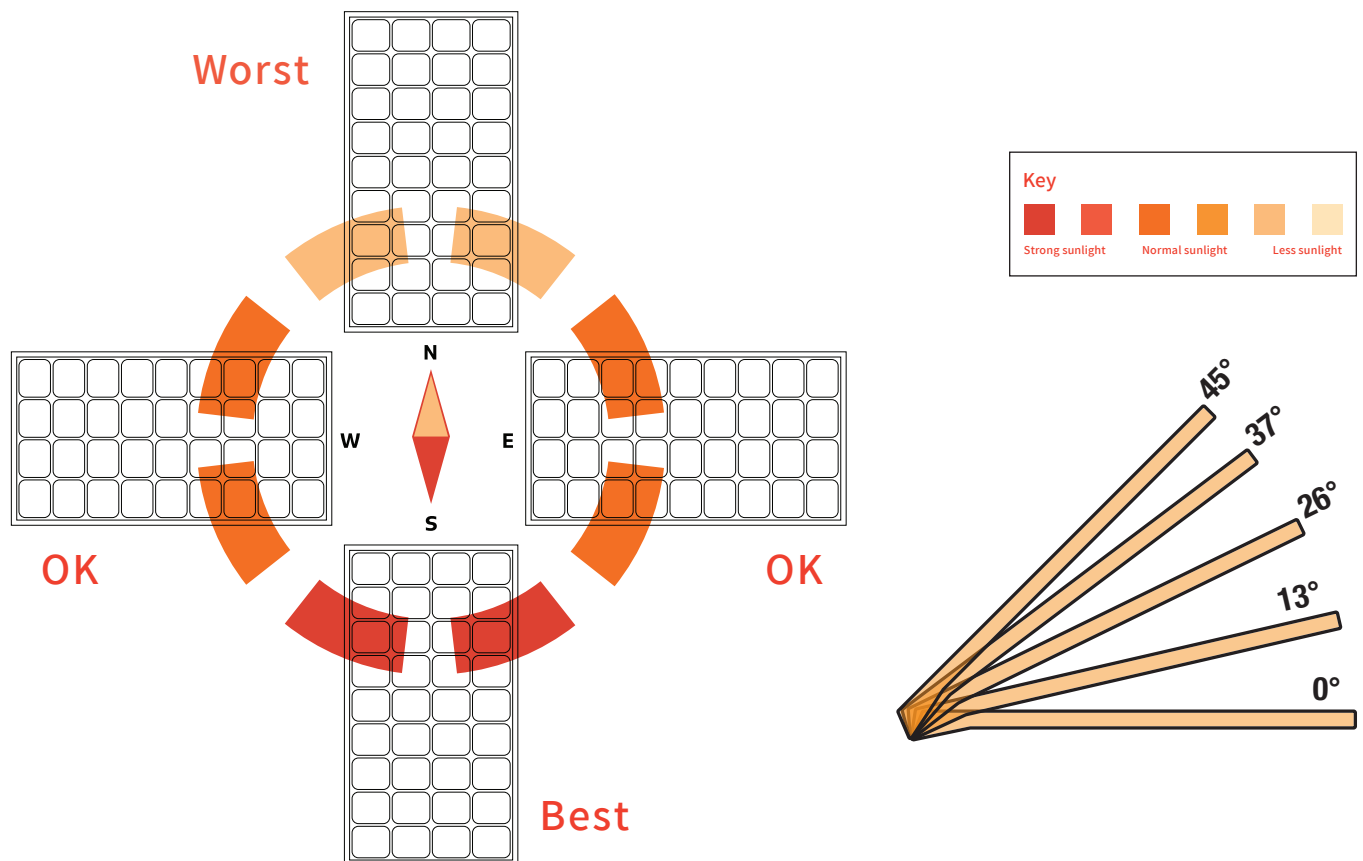

The area will dictate the installation of the fixtures and will sometimes prevent the lights from facing south. Panels facing West & East won't get as much light as Southern facing panels, but will still collect a good amount of sunlight. A North facing panel also works, but it will take longer to charge than any other direction. This would mean that the solar charge will be less optimal if installations are facing North.



RENEW™

Solar Wall Pack

Optimum Panel Orientation

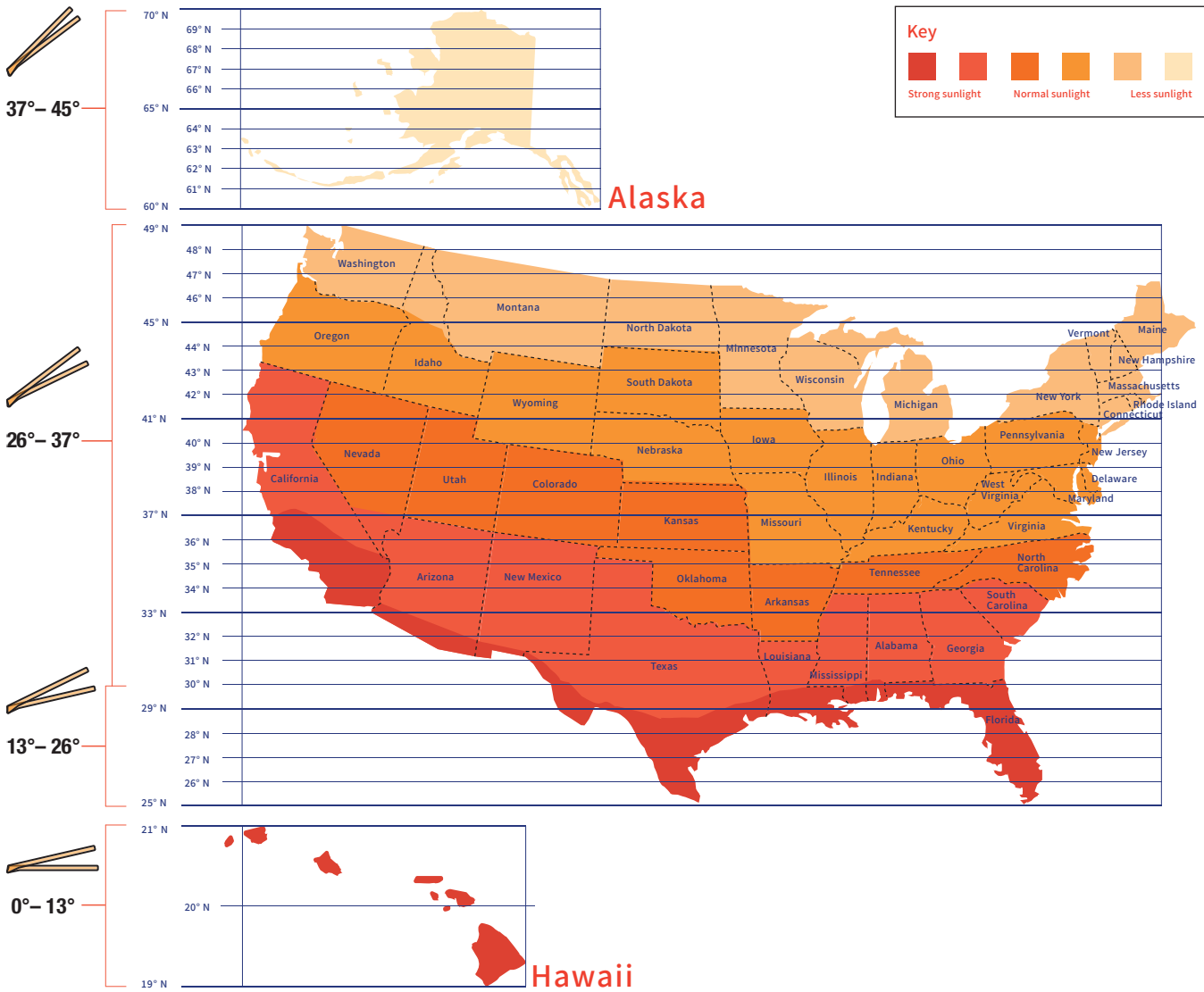

SOLAR WALL PACK

