



CASABREWS BRANDS INC.

1360 S Valley Vista Dr. , Suite 108

Diamond Bar, California 91765

United States of America

support@casabrews.com

www.casabrews.com

CASABREWS

CASABREWS

INSTRUCTION MANUAL

Espresso Coffee Machine

Model: 5700 PRO



Scan & Save!

**Scan the QR code, register your product,
and get a 6-month Extended Warranty!**

support@casabrews.com

HOUSEHOLD USE ONLY

Please read all instructions carefully before using the product

Contents

IMPORTANT SAFEGUARDS	1-3
KNOW YOUR COFFEE MACHINE	4
CONTROL PANEL	5
SPECIFICATIONS	6
BEFORE FIRST USE	7
FILLING THE WATER TANK	7
ATTACHING THE BEAN CONTAINER	7
ATTACHING THE FILTERHOLDER BRACKET	7
INITIAL USE	8
HOW TO USE THE GRINDER	9
SETTING THE GRIND SIZE	9
SELECTING THE FILTER SIZE	10
GRINDING THE COFFEE BEANS	10
AUTOMATIC GRINDING	10-11
MANUAL GRINDING	11
HOW TO TAMP THE GROUND COFFEE	12
DISTRIBUTING THE GROUND COFFEE	12
TAMPING THE GROUND COFFEE	12
HOW TO MAKE A ESPRESSO	13
INSERTING THE PORTAFILTER	13
MAKING ESPRESSO	13
IDEAL EXTRACTION	13
UNDER EXTRACTION	14
OVER EXTRACTION	14
HOW TO SET THE STEAM TEMPERATURE	14
HOW TO PROGRAM THE VOLUME OF SINGLE/DOUBLE ESPRESSO	15
PROGRAMMING ESPRESSO VOLUME	15
RESETTING TO DEFAULTS	16
HOW TO MAKE HOT WATER	16
HOW TO FROTH THE MILK	17-18
CLEANING AND MANTAINANCE	19
FLUSH CLEANING CYCLE	19
DESCALING	20
CLEANING THE GRINDER	21
CLEANING THE BREW HEAD	21
CLEANING THE FILTERS AND PORTAFILTER	22
CLEANING THE STEAM WAND	22
CLEANING THE DRIP TRAY	22
ERROR MODE	23-24
TROUBLESHOOTING	25-26
WARRANTY INFORMATION	27
CUSTOMER SUPPORT	27

IMPORTANT SAFEGUARDS

Before using the appliance, the following basic precautions should always be followed:

- 01.** Read all instructions.
- 02.** Before using check that the voltage of wall outlet corresponds to rated voltage marked on the rating plate.
- 03.** This appliance has been incorporated with a grounded plug. Please ensure the wall outlet in your house is well earthed.
- 04.** To protect against fire, electric shock and injury to persons, do not immerse main parts of the product, cord, or plug, in water or other liquid.
- 05.** The appliance must not be immersed.
- 06.** Remove plug from wall outlet before cleaning and when not in use. Allow appliance to cool down completely before taking off or attaching components or before cleaning.
- 07.** Do not operate any appliance with a damaged cord or plug or after the appliance malfunctions, or is dropped or damaged in any manner. Return appliance to the nearest authorized service facility or contact the manufacturer at their customer service telephone number for information on examination, repair or electrical or mechanical adjustment.
- 08.** The use of accessory attachments not recommended by the appliance manufacturer may result in fire, electric shock or injury to persons.
- 09.** Place appliance on flat surface or table, do not hang power cord over the edge of table or counter.
- 10.** Ensure the power cord does not touch the hot surface of the appliance.
- 11.** Do not place the coffee maker on hot surface or beside an open flame.
- 12.** To disconnect, remove plug from wall outlet. Always hold the plug, but never pull the cord.
- 13.** Do not use appliance for other than intended use and place it in a dry environment.
- 14.** Be careful not to get burned by the steam.
- 15.** Do not touch any hot surface of the appliance (such as steam wand, and the steel mesh . Use handle or knobs.

16. Do not let the coffee machine operate without water.
17. **DO NOT** remove the metal portafilter while brewing coffee. Metal parts will be hot. Please make sure to hold it by the handle and use caution when moving unit with hot liquids.
18. Connect plug to wall outlet before using and turn off all switches for plug is removed from the wall outlet. To unplug, grasp the plug and pull from the outlet. Never pull from the power cord.
19. This appliance can be used by children aged 8 years and above if they have been given supervision or instruction concerning use of the appliance in a safe way and if they understand the hazards involved. Cleaning and user maintenance shall not be made by children unless they are older than 8 and supervised. Keep the appliance and its cord out of reach of children under the age of 8. Close supervision is necessary when any appliance is used by or near children. Children should be supervised to ensure that they do not play with the appliance.
20. Appliances can be used by persons with reduced physical, sensory or mental capabilities or lack of experience and knowledge if they have been given supervision or instruction concerning use of the appliance in a safe way and understand the hazards involved.
21. Children shall not play with the appliance.
22. This appliance is intended for household use.
23. Do not use outdoors.
24. Avoid contact with moving parts.
25. Check bean container for presence of foreign objects before using.
26. Note the high temperature at the top of the machine.
- 27
 - a) A short power-supply cord (or detachable power-supply cord) is provided to prevent becoming entangled in or tripping over a longer cord.
 - b) Longer detachable power-supply cords or extension cords are available and maybe used if care is exercised in their use.
 - c) If a long detachable power-supply cord or extension cord is used:
 - 1) The marked electrical rating of the detachable power-supply cord or extension cord should be at least as great as the electrical rating of the appliance;

- 2) If the appliance is of the grounded type, the extension cord should be a grounding type 3-wire cord;
- 3) The longer cord should be arranged so that it will not drape over the counter top or table top where it can be pulled on by children or tripped over.

**SAVE THESE INSTRUCTIONS
FOR HOUSEHOLD USE ONLY**

⚠ WARNING To prevent hot steam and hot water from scalding the body or causing other personal injury, and also to prevent damage to the product, do not remove the water tank or portafilter when you use this coffee machine to brew coffee or froth milk. Before removing portafilter to brew another cup of coffee, make sure the coffee machine is in standby mode. If you want to add more water to the water tank, press the power button until the appliance powers off.

⚠ WARNING Do not touch the top cover of the machine after the machine has been working for a long time so as to prevent burns.

KNOW YOUR COFFEE MACHINE

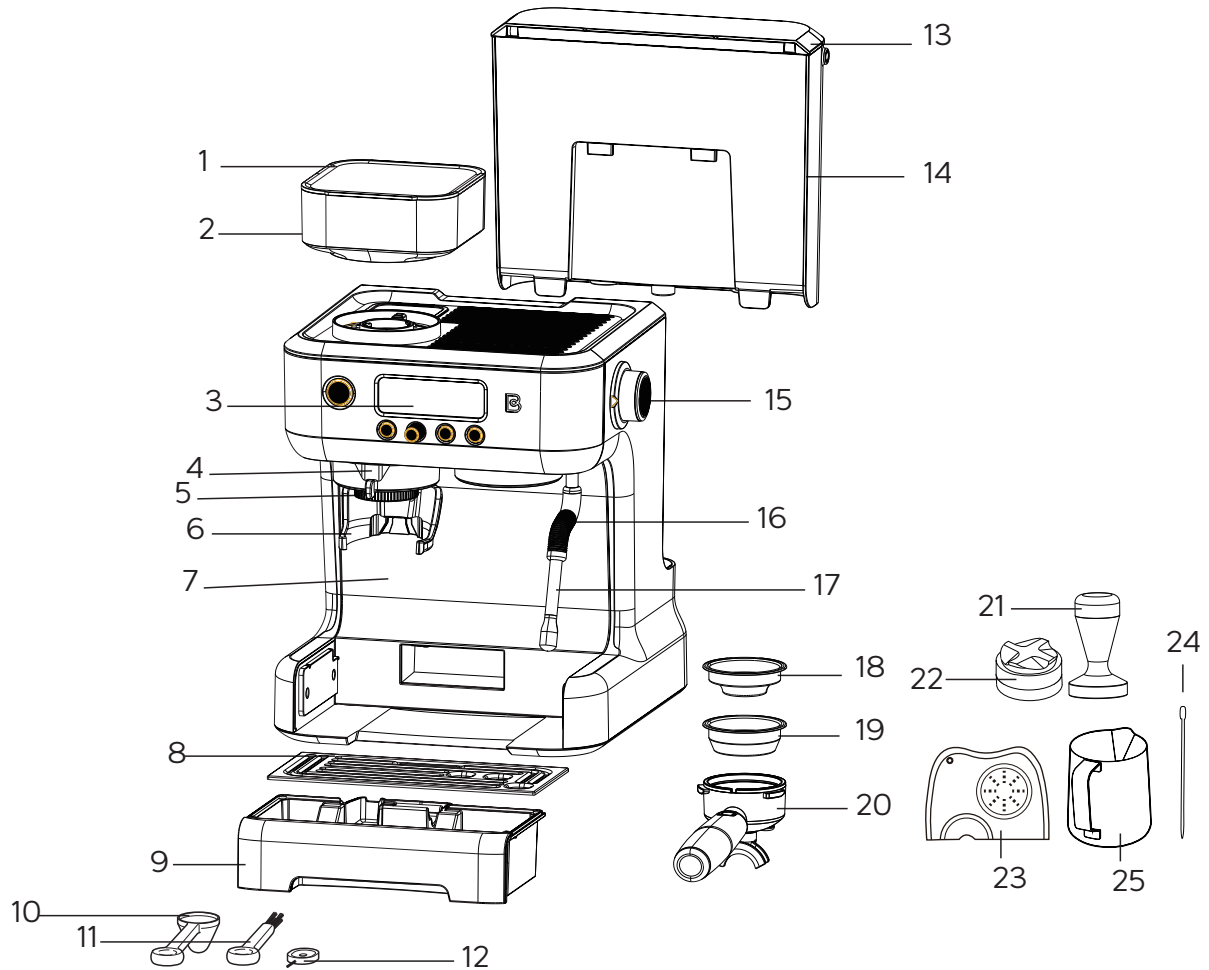

1. Bean Container Cover

2. Bean Container

3. Control Panel

4. Grinder

5. Powder Collector

6. Grind Bracket

7. Main Body

8. Drip Plate

9. Drip Tray

10. Coffee Spoon

11. Cleaning Brush

12. Cleaning Needle

13. Water Tank Cover

14. Water Tank

15. Steam Knob

16. Silicon Steam Tube

17. Steam Wand

18. Single Espresso Filter

19. Double Espresso Filter

20. Filter Holder/Portafilter

21. Tamper

22. Distributor

23. Tamping Mat

24. Decorating Pen

25. Milk Jug

CONTROL PANEL

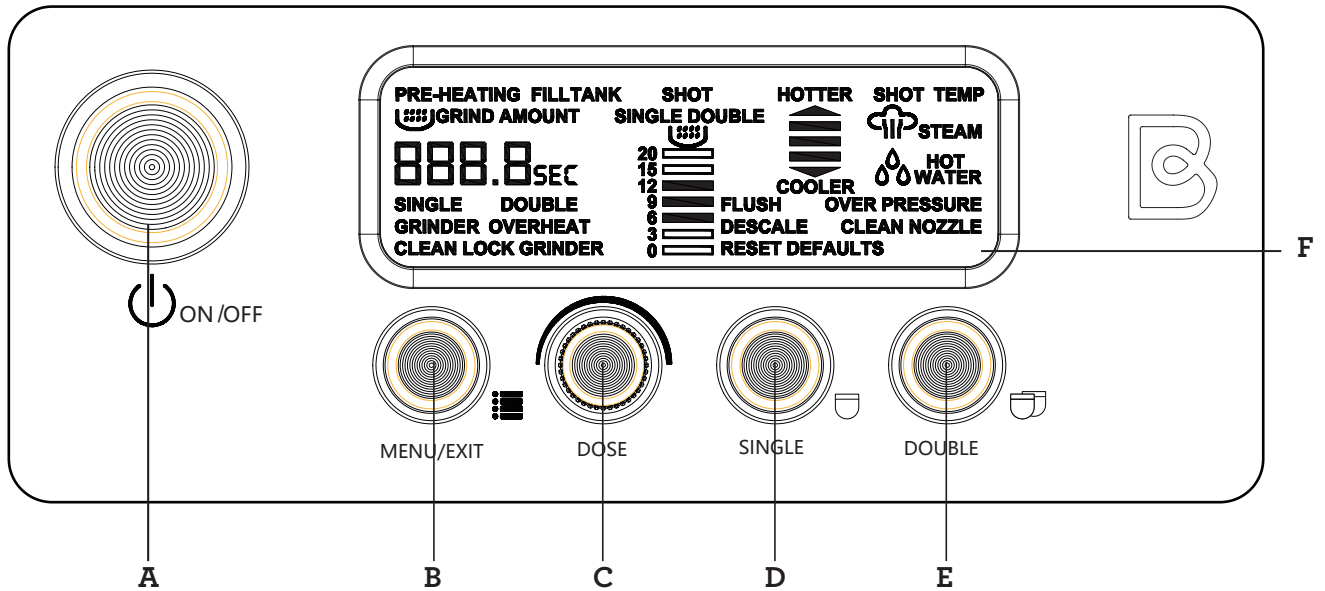

A. Power Button: Press to power on/off.

B. MENU/EXIT Button: Press to enter/exit the main menu.

C. DOSE Button: Press to select the single/double grind amount, turn to increase/decrease the grind time.

D. SINGLE Button: Press to brew a single espresso.

E. DOUBLE Button: Press to brew a double espresso.

F. LCD Display Screen: With grinding and extracting progress animations.

SPECIFICATIONS

Model:	5700 PRO
Voltage:	120V~ 60Hz
Power:	1500W
Pump:	Italian 20 Bar
Capacity of water tank:	2.7 L/91 OZ
Capacity of bean container:	200g
Product size:	13.62*11.85*16.22 inches
Net weight:	20.88 LBS
Length of power cord:	1 m

Dear customer,

Thank you for your purchase of the CASABREWS Espresso Coffee Machine. To ensure you get the best use of this machine, please take the time to read this manual and learn how to use this espresso machine with integrated grinder, even if you are an experienced home barista – this machine may be different to ones you have operated before. The operating instructions will show you how to use the product optimally and safely, and with a little experimenting you will soon find your preferred settings. We hope that you enjoy your purchase!

BEFORE FIRST USE

Remove and discard all labels and packaging materials attached to your espresso machine.

Ensure you have removed all parts and accessories before discarding the packaging.

Remove the packaging and the plastics bags containing the accessories.

Clean the water tank, portafilter, filter baskets, milk jug and drip tray using warm water and a gentle dishwashing liquid. Rinse well, then dry thoroughly before reassembling.

FILLING THE WATER TANK

Fill the water tank with cold potable tap water to below the MAX marking indicated on the side of the water tank.

NOTE: Replace the water daily. The water tank should be filled with fresh, cold tap water before each use.

ATTACHING THE BEAN CONTAINER

- 01.** Attach the bean container to the top of the machine. Ensure the mark “■” on the container aligns with the mark “▲” on the machine.
- 02.** Turn the bean container clockwise to secure it in place. Fill the bean container with fresh coffee beans.
- 03.** Fill the bean hopper with fresh coffee beans.

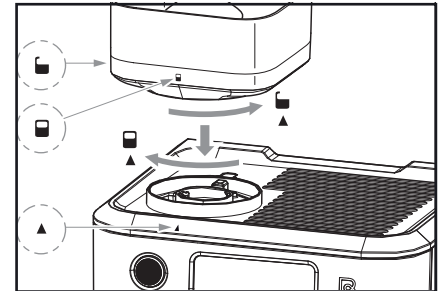

NOTE: The freshness of the coffee beans will affect the flavor of the coffee and the pressure of extraction. Using stale coffee beans may result in bitter and watery coffee. To get the best flavor and extraction, we recommend changing the coffee beans in the bean container at least once a week.

ATTACHING THE FILTERHOLDER BRACKET

Hang the portafilter bracket onto the machine by lifting it slightly, then push it downwards.

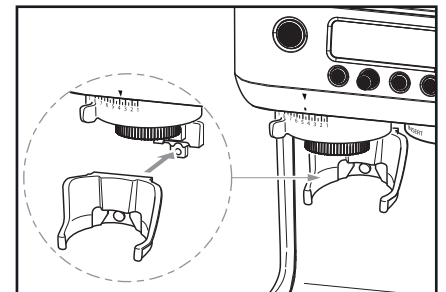

INITIAL USE

The initial use is necessary before using the machine. It will help to rinse the machine and prime the heating system before the first use.

- 01.** Fill the water tank with cold potable tap water, and fill the bean hopper with fresh coffee beans.
- 02.** Insert the plug into a wall outlet with suitable voltage (120V~, 60Hz).
- 03.** Press the Power button. The button indicators turn on and the coffee machine starts to preheat automatically. Once the preheating has finished, all the buttons will light up continuously. The machine is in READY mode.

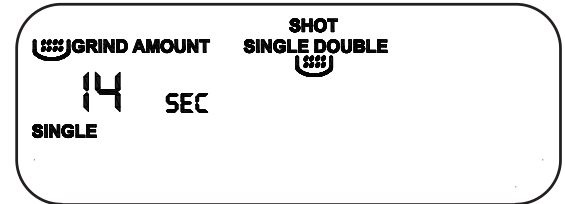

"READY" mode

This preheating process takes about 2 minutes.

- 04.** Place an empty cup under the steam wand.
- 05.** Turn the steam knob to the "HOT WATER" position. Let the hot water dispense from the steam wand for eight seconds, then return the steam knob to OFF. This process allows the water to flow through the empty pump for the first use.
- 06.** Pour out the hot water and place the empty cup under the brew head.
- 07.** Press the single button once. Let the machine run through a cycle.
- 08.** After the brewing cycle has finished, pour the water out.

Now your machine is ready to use.

HOW TO USE THE GRINDER

When grinding coffee beans, the grind size should be fine, but not too fine. The grind size will affect the rate at which water flows through the ground coffee in the filter, the pressure of extraction and the taste of the espresso.

If the grind is too fine, the water will not flow through the coffee, even when under pressure. The resulting espresso will be **OVER EXTRACTED**, dark in color and bitter in flavor.

If the grind is too coarse, the water will flow through the ground coffee in the filter too quickly, and the pressure will be under 5 bar. The resulting espresso will be **UNDER EXTRACTED** and lacking in color and flavor.

SETTING THE GRIND SIZE

This machine has 15 grind settings to select from. The smaller the number, the finer the grind size; the larger the number, the coarser the grind size.

Use the GRIND SIZE selector to adjust the grind size.

For a new user, we suggest setting the grind setting to 8 initially, and then make adjustments depending on the extraction of the coffee and the pressure shown by the pressure gauge.

Select a finer grind setting when the pressure is under 5 bar then retry.

Select a coarser grind setting when the pressure is over 12 bar then retry.

The grind setting will vary depending on the coffee bean you used. You may need to experiment with which the grind setting should be chosen to achieve the idea pressure.

NOTE: Do not set the grind setting at 1-3 initially. No coffee grounds may come out because the grind settings are too fine when the machine is new. The grinder will become more suitable with prolonged use of the machine.

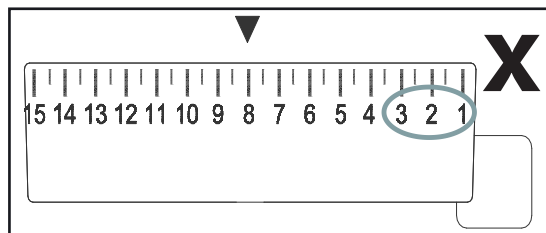
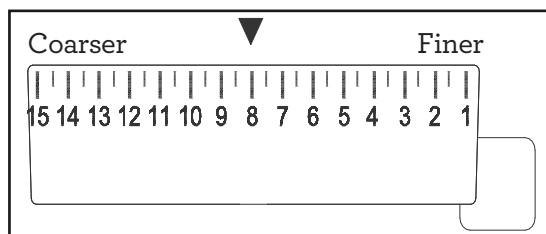

⚠ WARNING Only grind roasted coffee beans in this machine. Do not process any other foods, such as nuts, spices or liquids, to avoid damaging the grinder. Please do not operate the grinder when it is empty, i.e. without coffee beans.

SELECTING THE FILTER SIZE

This machine includes 2 single wall filters: a “single espresso” filter and a “double espresso” filter.

The provided filters are designed for:

single espresso filter = approx. 11-13g

double espresso filter = approx. 19-21g

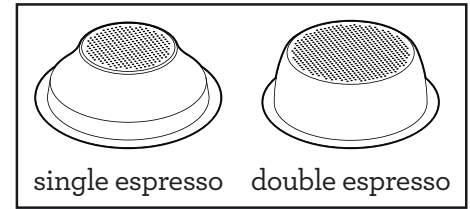

Insert either the single espresso size filter or double espresso size filter into the portafilter.

Select the single espresso size filter if you want to make a single espresso and double espresso size filter if you want to make a double.

You will need to adjust the grind amount and size if switching from a single to a double filter, or vice versa.

GRINDING THE COFFEE BEANS

The grind amount will also affect the rate at which water flows through the ground coffee in the filter, the pressure of extraction and the taste of the espresso.

Grinding too much coffee will lead to OVER EXTRACTION, and not grinding enough will lead to UNDER EXTRACTION.

AUTOMATIC GRINDING

- 01.** Ensure the filter bracket is locked in place.
- 02.** Insert the portafilter into the bracket.
- 03.** If required, press the DOSE button to select the filter basket size; Single or Double.
- 04.** If required, turn the DOSE dial to change the grind time; clockwise to increase the time and anti-clockwise to decrease.

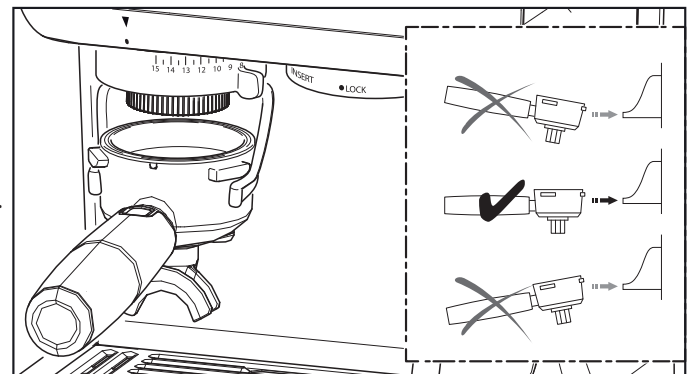

NOTE:

The default grind times are 14 seconds for a single espresso filter and 21 seconds for a double espresso filter.

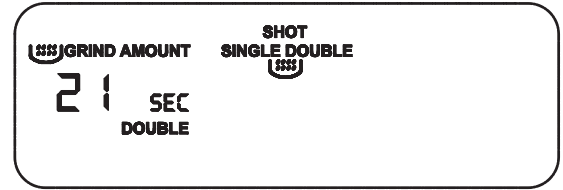
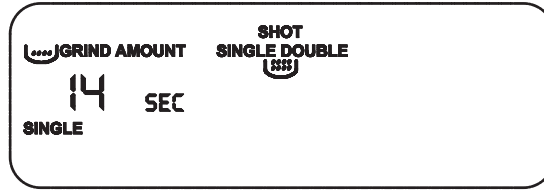

05. Push and release the portafilter to activate automatic grinding. The LCD will show the filter filling, and the timer starts counting down.
06. If you need to pause the grinding process, push and release the portafilter. The machine will pause grinding, and the grind time stops counting down. It will remain paused for 15 seconds before returning to READY mode.
07. Push and release the portafilter to resume grinding.

NOTE:

It is normal for the portafilter to appear overfilled with ground coffee.

NOTE:

The grinding time will vary depending on the coffee bean you used. You may need to experiment with how long the grinder needs to run to achieve the correct dose.

MANUAL GRINDING

To manually grind the coffee bean, push and hold the portafilter in the bracket until the desired amount of ground coffee has been ground. To stop grinding, release the portafilter.

The timer will count up, displaying the grind time.

HOW TO TAMP THE GROUND COFFEE

DISTRIBUTING THE GROUND COFFEE

- 01.** Remove the portafilter from the bracket.
- 02.** Using the distributor, tamp down firmly on the coffee. Then rotate the distributor to even the surface of the ground coffee.

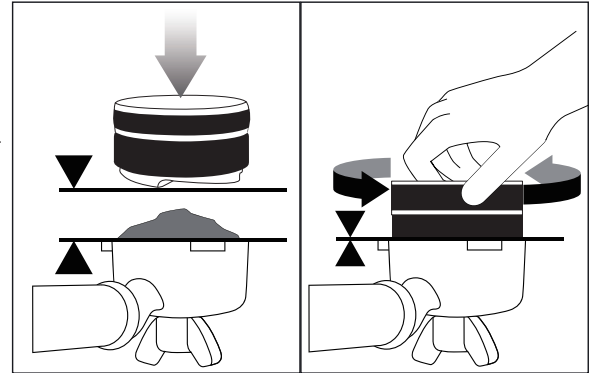

TAMPING THE GROUND COFFEE

- 01.** Using the tamper, tamp down firmly using approx. 11-22lbs (5-10kg) of pressure.
- 02.** Wipe excess coffee from the rim of the filter to ensure a proper seal is achieved in the brew head.

As a guide to using the right amount of ground coffee, the top edge of the metal cap on the tamper should be level with the top of the filter after the ground coffee has been tamped.

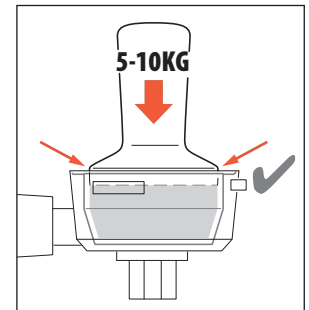

Also, the MAX marks in both of the filters are intended to assist in identifying the correct quantity of ground coffee more easily.

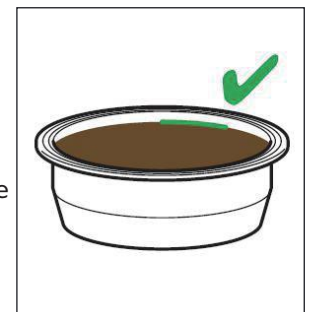

NOTE:

The surface of ground coffee should not be beyond the MAX mark after tamping, otherwise the portafilter might not be able to be locked into the brew head.

HOW TO MAKE A ESPRESSO

INSERTING THE PORTAFILTER

Place the portafilter underneath the brew head so that the handle is aligned with the INSERT position. Insert the portafilter into the brew head and rotate the handle towards the centre until firm resistance is felt.

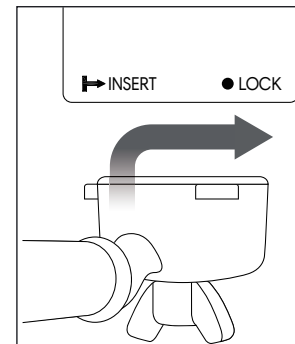

MAKING ESPRESSO

- 01.** Place a pre-warmed cup beneath the portafilter.
- 02.** Press the single or double button for desired volume. The machine starts brewing.
- 03.** The LCD will show the pressure of extraction, and the timer will start to count up.
- 04.** The pre-programmed volume of a single espresso is approx. 30ml, and the double espresso is approx. 60ml.
- 05.** The machine will automatically stop once the pre-set volume has been extracted, and the LCD will go back to standby mode.

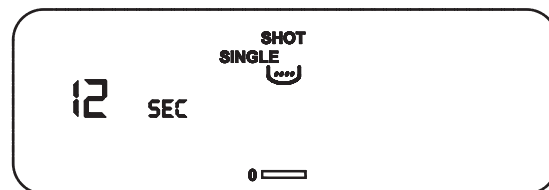

Brewing a single espresso

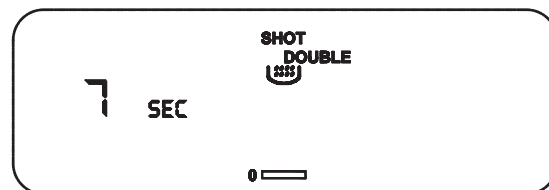

Brewing a double espresso

IDEAL EXTRACTION

If the pressure shown on the LCD is between 6-12 bar, it means the espresso has been extracted at the ideal pressure.

Features:

- * Slow flow like warm honey.
- * Crema is golden brown with a fine mousse texture.
- * Espresso is dark brown.

UNDER EXTRACTION

If the pressure shown on the LCD is under 6 bar, you do not have enough ground coffee in the filter and /or the grind is too coarse. This is an UNDER EXTRACTED shot.

Features:

- * Fast flow like water.
- * Crema is thin and pale.
- * Espresso is pale brown.
- * Tastes bitter/sharp, weak and watery.

Solutions:

- * Select a finer grind setting and retry.
- * Increase the amount of ground coffee and retry.
- * Increase the tamping pressure and retry.

OVER EXTRACTION

If the pressure shown on the LCD is over 12 bar, you have either too much ground coffee in the filter and /or the grind is too fine. This is an OVER EXTRACTED shot.

Features:

- * Flow drips very slowly or not at all.
- * Crema is dark and spotty.
- * Espresso is very dark brown.
- * Tastes bitter and burnt.

Solutions:

- * Select a coarser grind setting and retry.
- * Decrease the amount of ground coffee and retry.
- * Decrease the tamping pressure and retry.

HOW TO SET THE SHOT TEMPERATURE

01. Press the MENU button to enter the main menu.

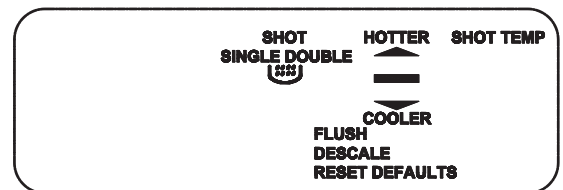

The main menu

02. Use the DOSE dial to navigate through the menu, select SHOT TEMP then press the DOSE dial.

03. Turn the DOSE dial to select the shot temperature you want, then press the DOSE dial.

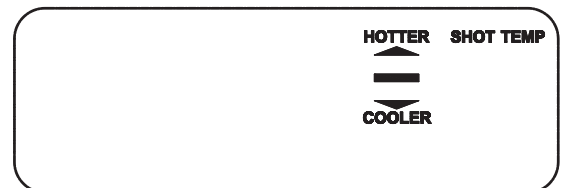

Selecting the shot temperature

04. The machine will beep to indicate that the customer setting has been programmed. The machine will return to READY mode.

HOW TO PROGRAM THE VOLUME OF SINGLE/DOUBLE ESPRESSO

PROGRAMMING ESPRESSO VOLUME

01. Press the MENU button to enter the main menu.

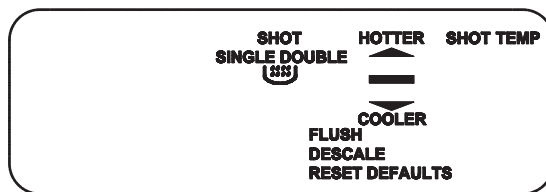

The main menu

02. Use the DOSE dial to navigate through the menu to SINGLE or DOUBLE SHOT. To select, press the dial.

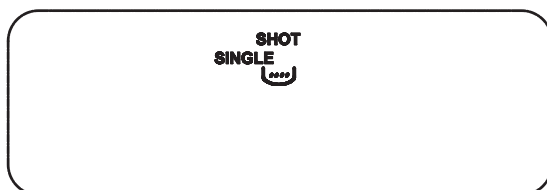

When select to program the volume of single espresso

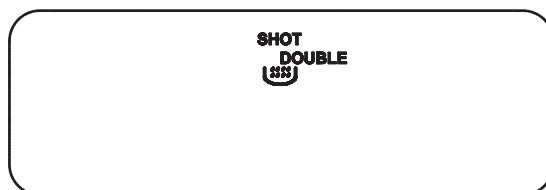

When select to program the volume of double espresso

03. Press the single or double button, the machine starts to brew. The single or double button will flash when brewing.

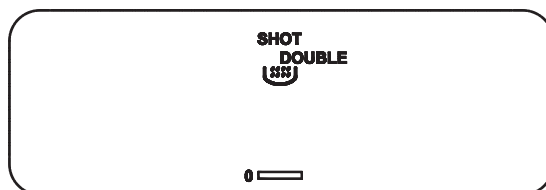
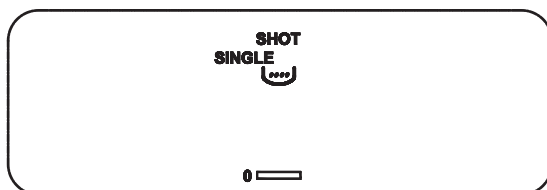

04. To stop the extraction at the desired level, press the single or double button again. The LCD and single/double button will stop flashing and the machine will beep to indicate that the custom setting has been programmed. The machine will then return to READY mode. The custom setting can now be activated by pressing the single or double button.

NOTE:

The adjustable volume for a single espresso ranges between 20 ml/0.68 oz and 60 ml/2.03 oz, and a double espresso ranges between 60ml/2.03 oz and 100 ml/3.38 oz. The machine will fail to program volumes outside of this range.

RESETTING TO DEFAULTS

01. Press the MENU button to enter the main menu.

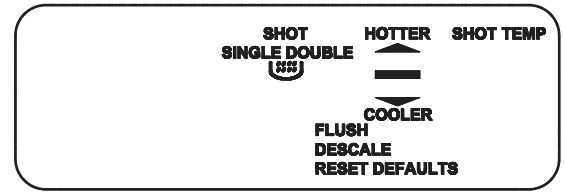

The main menu

02. Use the DOSE dial to navigate through the menu, select RESET DEFAULTS then press the DOSE dial.
03. The machine will beep.
04. The GRIND AMOUNT, SHOT TEMP, single espresso and double espresso volume settings will all return to the default settings. The machine will return to READY mode.

HOW TO MAKE HOT WATER

The hot water function can be used to clean and preheat cups, or to add hot water manually. To activate the hot water, turn the STEAM knob to HOT WATER.

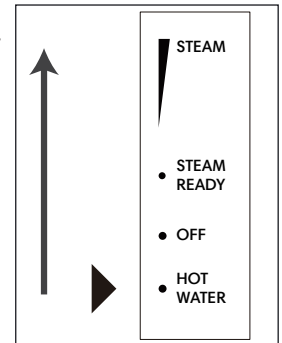

The LCD will show that HOT WATER has been activated, and the timer starts to count up.

To stop the hot water, turn the knob back to the OFF position.

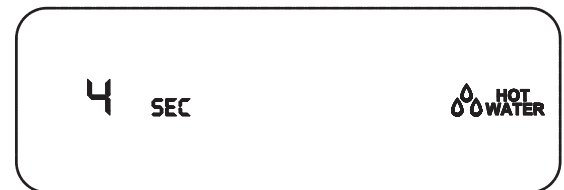

Making hot water

NOTE:

The hot water will stop after 45 seconds automatically, but the knob must be turned back manually to the standby position.

HOW TO FROTH THE MILK

It is recommended to flush the steam wand prior to frothing milk.

- 01.** Position the steam wand over the drip tray and turn the STEAM knob to the STEAM READY position. The machine starts to preheat, and the indicator will flash. The LCD will display STEAM and the timer will stay at 0 when preheating.

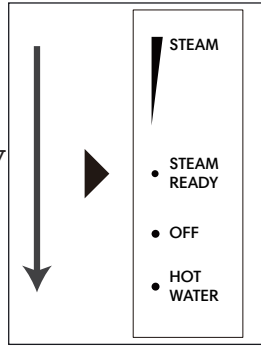

Preheating for making steam

- 02.** Once the preheating has finished, the indicator will light up continuously.

- 03.** Turn the knob to the STEAM position. The LCD will display STEAM and the timer starts to count up.

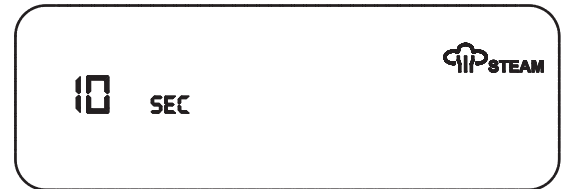
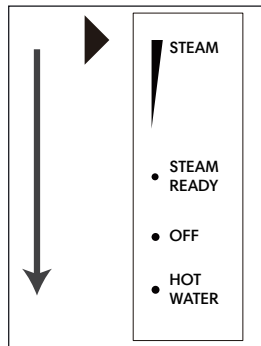

Making steam

- 04.** Let steam come out of the steam wand for approx. 8 seconds, then return the knob to STEAM READY position.

This process is to purge out the residual water inside the steam wand.

We recommend using cold, fresh whole milk. The density of the frothed milk will depend on the milk fat content.

- * Fill the milk jug to between the MIN and MAX markings.
- * Lift the steam wand and insert it into the milk jug with the steam wand tip just below the surface of the milk, close to the right-hand side of the jug at a 3 o'clock position.
- * Turn the STEAM knob to the STEAM position.
- * Keep the steam wand tip just under the surface of the milk until the milk is spinning clockwise, producing a vortex.

- * With the milk spinning, slowly lower the jug. This will bring the steam wand tip to the surface of the milk and start to introduce air into the milk.
- * Gently break the surface of the milk with the tip to get the milk spinning fast enough.
- * Keep the steam wand tip at or slightly below the surface, continuing to maintain the vortex.
- * Texture the milk until sufficient volume is obtained.
- * Lift the jug to lower the tip beneath the surface but keep the vortex spinning. The milk is at the correct temperature (140-149°F / 60-65°C) when the jug is hot to the touch.
- * Once the desired temperature has been achieved, turn the STEAM knob back to the OFF position.
- * Remove the steam wand from the milk jug.
- * Wipe the steam wand with a clean, damp cloth. Then return to lowered position over the drip tray.

NOTE: Ensure the STEAM knob is in the OFF position before removing the steam wand from the milk jug.

After frothing milk, it is recommended to flush the residual milk from the steam wand.

The LCD will display CLEAN NOZZLE 5 times to remind you to clean the steam wand.

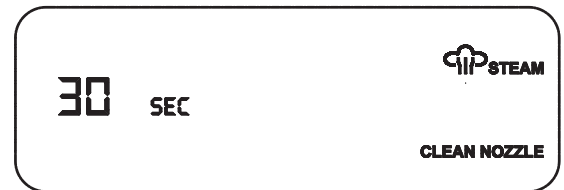

CLEANING AND MANTAINANCE

Caution:

To prevent damage to the appliance, do not use alkaline cleaning agents when cleaning, use a soft cloth and mild detergent.

FLUSH CLEANING CYCLE

FLUSH cycle can keep the machine in working order and ensure perfect coffee flavor, a constant coffee flow, and excellent milk froth for a long period of time.

We recommend doing a FLUSH cycle at least once a week.

- 01.** Insert a empty filter into the portafilter.
- 02.** Lock the portafilter into the brew head.
- 03.** Empty the drip tray and replace onto the machine.
- 04.** Fill the water tank to the MAX line then reattach to the machine.
- 05.** Put a empty cup beneath the portafilter and position the steam wand in the direction of the drip tray.
- 06.** Press the MENU button to enter the main menu.
- 07.** Use the DOSE dial to navigate through the menu to FLUSH, then press to start the cleaning cycle.

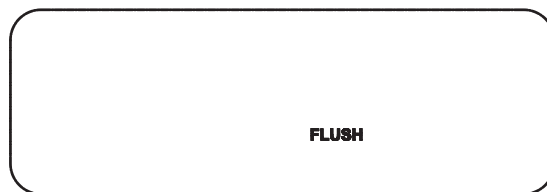

Running the FLUSH cycle

- 08.** Once the FLUSH cleaning cycle is complete, the machine will beep and return to READY mode.
- 09.** Empty and rinse the cup and portafilter, and clean the drip tray.

DESCALING

After regular use, hard water can cause mineral build up in and on many of the inner functioning components, reducing the brewing flow, brewing temperature, power of the machine, and the taste of the espresso.

We recommend doing a DESCALE cycle at least once a month.

- 01.** Empty the drip tray and reattach to the machine. Remove the water tank from the machine.
- 02.** Fill the water tank to the MAX line indicated and add the descaling agent to the water. Reattach the water tank to the machine.
- 03.** Put a empty cup beneath the portafilter, and put another empty cup beneath the steam wand.
- 04.** Press the MENU button to enter the main menu. Use the DOSE dial to navigate through the menu to DESCALE, then press to start the descaling cycle.



Running the DESCALE cycle

- 05.** Once the descale cycle is complete, the machine needs to complete a rinse cycle.
- 06.** Empty the cups then put back into position. Empty any remaining descaling liquid from the water tank, then fill the water tank to the MAX line and reattach it to the machine.
- 07.** Press the MENU button to enter the main menu. Use the DOSE dial to navigate through the menu to DESCALE, then press to start the descaling cycle.
- 08.** Once the DESCALE cycle is complete, the machine will beep and return to READY mode.
- 09.** Remove and rinse the water tank. Dry thoroughly before reattaching it to the machine.

CLEANING THE GRINDER

The grinder must be removed from the espresso machine for cleaning.

01. Turn the bean container counter clockwise to remove it from the machine, and remove the bracket.
02. Press and hold the release button (the red button below the mark ☐), then turn the grinder counter clockwise (see below image) and pull it downward. The LCD will show “LOCK GRINDER”.

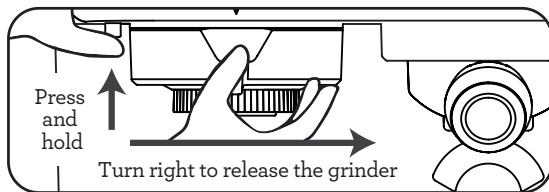

Disassemble the grinder

PRE-HEATING
GRIND AMOUNT
14 SEC
SINGLE
LOCK GRINDER

Remind lackage of the grinder

03. Turn the grinder upside-down and rotate the powder collector clockwise (☐ → ☐), to remove it from the grinder via the locking position.
04. Clean the grinder and the powder collector carefully using the cleaning brush.
05. After cleaning, reattach the powder collector to the grinder by rotating it counter clockwise.
06. Insert the grinder into the machine upward as far as it will go. Then hold the grinder and turn it counter clockwise to lock it (see below image). Once the grinder is attached in place, you can hear a “click” sound and feel it tight in place. The LCD will no longer show “LOCK GRINDER”.

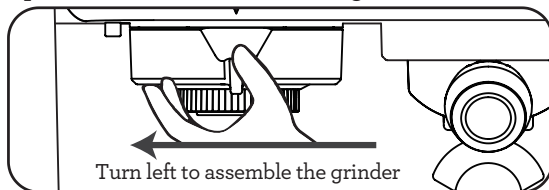

Attach the grinder

PRE-HEATING
GRIND AMOUNT
14 SEC
SINGLE

Grinder in place

07. Reattach the bean container and bracket into the machine.

CLEANING THE BREW HEAD

The brew head interior and shower screen should be wiped with a damp cloth after use to remove any ground coffee particles.

Periodically purge the machine. Place an empty filter basket and portafilter into the brew head. Press the single button and run a short flow of water to rinse out any residual coffee. Remove the portafilter and rinse thoroughly.

CLEANING THE FILTERS AND PORTAFILTER

The filters and portafilter should be rinsed under hot water immediately after use to remove all residual coffee oils.

If any of the holes in the filter become blocked, use the pin provided to unblock the holes.

If the holes remain blocked, soak filter and portafilter in hot water for approx. 20 minutes. Rinse thoroughly.

NOTE:

All parts should be cleaned by hand using warm water and a gentle dishwashing liquid. Do not clean any of the parts or accessories in the dishwasher.

CLEANING THE STEAM WAND

The steam wand should always be cleaned after frothing milk. Wipe the steam wand with a damp cloth.

After use, it is recommended to purge the steam wand for a couple of seconds, to clear any remaining milk. With the steam wand positioned down over the drip tray, turn the STEAM knob downward a couple of seconds to allow the machine to create steam before turning it back to the vertical position.

If the steam tip hole becomes blocked, it will reduce frothing performance. Use the provided steam wand cleaning pin to clear the opening.

If the steam wand is still blocked, unscrew the tip and soak the tip in hot water before using the cleaning pin to unblock again. Replace the tip back on the steam wand.

CLEANING THE DRIP TRAY

The drip tray should be removed, emptied and cleaned at regular intervals, particularly when the drip tray full indicator is showing PLEASE EMPTY TRAY.

Remove the drip tray from the machine and separate the parts. Wash all parts in warm soapy water with a soft cloth. Rinse and dry thoroughly before reassembling and attaching to the machine.

ERROR MODE

FILL TANK

When the water is used up or the water tank is not attached in place, the machine will show “FILL TANK” on the LCD.

Once the water is filled or the tank is reattached, “FILL TANK” will disappear.

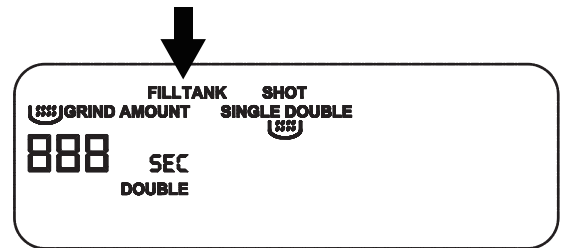

GRINDER OVERHEAT

If the machine shows “GRINDER OVERHEAT” on the LCD, unplug the machine and then plug it back in again.

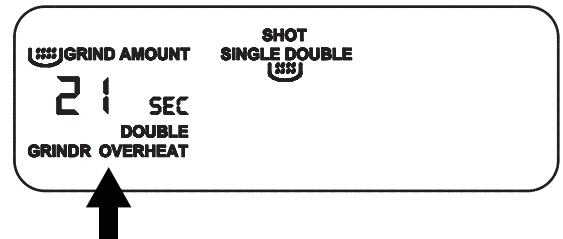

CLEAN GRINDER

If the machine shows “CLEAN GRINDER” on the LCD, remove and clean the grinder, then reattach the grinder to the machine.

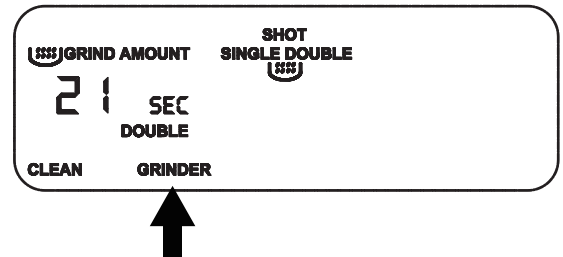

E01

If the machine show “E01” on the LCD, check and return the STEAM knob to the “OFF” position.

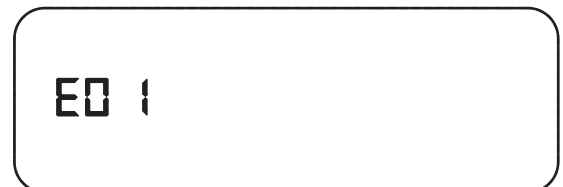

E02

If the machine shows “E02” on the LCD, press either the single or double button.

A rounded rectangular box representing an LCD display showing the error code "E02" in a digital font.

E 0 2

E10

If the machine shows “E10” on the LCD, please contact our customer support team.

A rounded rectangular box representing an LCD display showing the error code "E10" in a digital font.

E 1 0

C00

If the machine shows “C00” on the LCD, please contact our customer support team.

A rounded rectangular box representing an LCD display showing the error code "C00" in a digital font.

C 0 0

TROUBLESHOOTING

PROBLEM	POSSIBLE CAUSE	SOLUTION
Water does not flow from the brew head.	Water tank is empty.	Fill tank.
	Water tank is not fully inserted and locked into position.	Push water tank down completely to lock into place.
	Machine needs to be descaled.	Run descale cycle.
	The filter may be blocked.	Clean the filter.
Espresso only drips from the portafilter spouts or not at all. The pressure is over 12 bar (OVER EXTRACTION).	Water tank is empty.	Fill tank.
	Water tank is not fully inserted and locked into position.	Push water tank down completely to lock into place.
	Coffee is ground too finely.	Use a coarser grind.
	Too much ground coffee in the filter.	Decrease the amount of ground coffee.
	Coffee tamped too firmly.	Tamp between or 11-22 lb of pressure.
	The filter may be blocked.	Clean the filter.
	Machine needs to be descaled.	Run descale cycle.
Espresso runs out too quickly. The pressure is under 6 bar (UNDER EXTRACTION).	Coffee is ground too coarsely.	Use a finer grind.
	Not enough ground coffee in the filter.	Increase the amount of ground coffee.
	Coffee tamped too lightly.	Tamp between or 11-22 lb of pressure.
Espresso or water runs out around the edge of the portafilter.	Portafilter not inserted in the brew head correctly.	Ensure portafilter is completely inserted and rotated until resistance is felt.
	There are coffee grounds around the filter basket rim.	Remove any residual ground coffee from the rim of the filter to ensure a proper seal in group head.
	There are coffee grounds on the surface of the brew head.	Clean any residual ground coffee from the surface of the brew head.
	Too much ground coffee in the filter basket.	Decrease the amount of ground coffee.
No steam.	Water tank is empty.	Fill tank.
	Water tank is not fully inserted and locked into position.	Push water tank down completely to lock into place.
	Machine needs to be descaled.	Run descale cycle.
	Steam wand is blocked.	Clean the steam wand.

Coffee not hot enough.	Cups not pre-heated.	Rinse cups under hot water.
	Portafilter not pre-heated.	Rinse portafilter under hot water.
	Brew head not pre-heated.	Run a single shot without ground coffee.
Water leaking from bottom.	Water tank is not fully inserted and locked into position.	Push water tank down completely to lock into place.
	Water tank is broken.	Contact our customer support team.
No ground coffee coming from grinder.	No coffee beans in hopper.	Filler hopper with fresh coffee beans.
	Blocked grinder chamber or chute.	Clean and clear grinder chamber and chute.
	Blockage or foreign object in grinder.	Remove hopper, check for debris or blockage. If necessary, clean and clear grinder chamber and chute.

NOTE:

If your problem is not listed here, please contact Customer Support.

WARRANTY INFORMATION

The manufacturer provides warranty in accordance with the legislation of the customer's own country of residence, with a minimum of 12 months, starting from the date on which the appliance is sold to the end user.

The warranty only covers defects in material or workmanship.

The warranty will not apply in cases of:

- Normal wear and tear.
- Incorrect use, e.g. overloading of the appliance, use of non-approved accessories.
- Use of force, damage caused by external influences.
- Damage caused by non-observance of the user manual, e.g. connection to an unsuitable mains supply or non-compliance with the installation instructions.
- Partially or completely dismantled appliances.

CUSTOMER SUPPORT

If you have any questions or concerns about your new product, please contact our helpful Customer Support Team.

Contact our team by email :

Support@CASABREWS.com

Or scan the QR code for an additional barista book and more support.



* Please have your invoice and order ID ready before contacting Customer Support.

