

CASABREWS

INSTRUCTION MANUAL

Espresso Coffee Machine

Model: 4700 GENSE



Scan & Save!

**Scan the QR code, register your product,
and get a 6-month Extended Warranty!**

support@casabrews.com

HOUSEHOLD USE ONLY

Please read all instructions carefully before using the product

CONTENTS

IMPORTANT SAFEGUARDS	1-2
SPECIFICATION	2
KNOW YOUR COFFEE MACHINE	3
CONTROL PANEL	4
BEFORE FIRST USE	5-6
PREPARING ESPRESSO	7
SETTING THE ESPRESSO TEMPERATURE	7
MAKING ESPRESSO	8
MAKING AMERICANO	9
FROTHING MILK	10-11
MAKING HOT WATER	12
AUTO SHUT-OFF FUNCTION	12
WATER SHORTAGE ALARM	13
PROGRAMMING THE VOLUME OF ESPRESSO	13-14
CLEANING AND MAINTENANCE	14-16
CLEANING THE FILTER HOLDER AND THE FILTERS	14-15
CLEANING THE STEAM WAND	15
CLEANING THE BREW HEAD	16
DESCALING THE APPLIANCE	16
TROUBLESHOOTING	17-18
WARRANTY INFORMATION	19
CUSTOMER SUPPORT	19

IMPORTANT SAFEGUARDS

Before using this machine, please follow these basic precautions:

- 01.** This machine is not intended for use by persons (including children) with reduced physical, sensory or mental capabilities, or lack of experience and knowledge, unless they have been given supervision or instruction concerning use of the machine by a person responsible for their safety.
- 02.** Children should be supervised to ensure that they do not play with the machine.
- 03.** This machine can be used by children aged from 8 years and above and persons with reduced physical, sensory or mental capabilities or lack of experience and knowledge if they have been given supervision or instruction concerning use of the machine in a safe way and understand the hazards involved. Children shall not play with the machine.
- 04.** Check the machine before each use and ensure that the machine, power cord and plug are not damaged and no parts have come loose.
- 05.** If the supply cord is damaged, it must be replaced by the manufacturer, its service agent or similarly qualified persons in order to avoid a hazard.
- 06.** This machine is intended to be used in household and similar applications such as:
 - staff- kitchen areas in shops, offices and other working environments;
 - farm houses;
 - by clients in hotels, motels and other residential type environments;
 - bed and breakfast type environments.
- 07.** The machine must not be immersed in water.
- 08.** The heating element surface is subject to residual heat after use.
- 09.** Cleaning and user maintenance shall not be made by children without supervision.
- 10.** Never touch the hot machine parts like the steam/hot water outlet, the metal part of the portafilter or the filter during or shortly after use. Only touch the heat insulated handles, buttons or selectors.

11. Never take the portafilter off while the machine performs a brewing process or steams milk-the machine is pressurised!
12. Never point the steam / hot water wand towards persons, animals or steam and moisture sensitive furniture! The escaping steam or the water is very hot and could cause scalding!
13. Only cups and tamper may be placed on the cup tray. Do not place any other items on the machine.

CAUTION: After prolonged use, the cup shelf gets so hot that you might scald yourself on it!

14. Do not leave the espresso machine unattended when in use. This applies especially when children are nearby.

CAUTION: The machine becomes very hot during use! Allow the machine to cool down before removing or attaching parts, moving, relocating or cleaning it.

15. Oils or lubricants must not be used with this machine.
16. Pull the plug after every use. Only then, the machine is fully switched off.

SAVE THESE INSTRUCTIONS

HOUSEHOLD USE ONLY

SPECIFICATION:

Model:	4700 GENSE
Rated Voltage:	120V~ 60Hz
Power:	1350W
Capacity of Water Tank:	1.5L/51oz
Product Size:	12.2*7.87*15.55 INCH
Product Weight:	12.14 LBS

KNOW YOUR COFFEE MACHINE

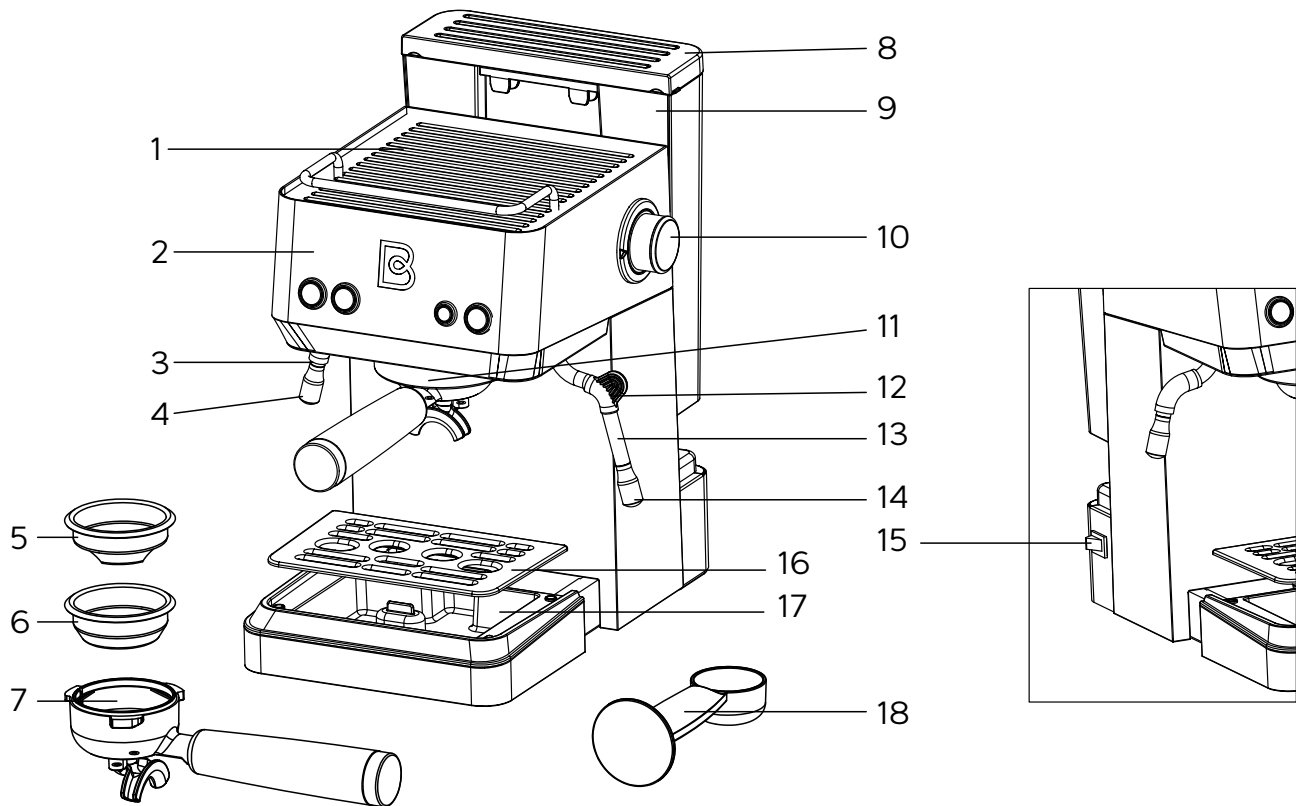

- 1. Cup Warmer;
- 2. Control Panel;
- 3. Hot Water Wand;
- 4. Hot Water Spout;
- 5. Single Shot Filter;
- 6. Double Shot Filter;

- 7. Portafilter/Filter Holder;
- 8. Water Tank Lid;
- 9. Water Tank;
- 10. Steam Knob;
- 11. Brew Head;
- 12. Thermo-insulated Handle;

- 13. Steam Wand;
- 14. Steam Nozzle;
- 15. Power Button
(Press to power on/off);
- 16. Drip Tray Grid;
- 17. Drip Tray;
- 18. Measure Spoon with Tamper;

CONTROL PANEL

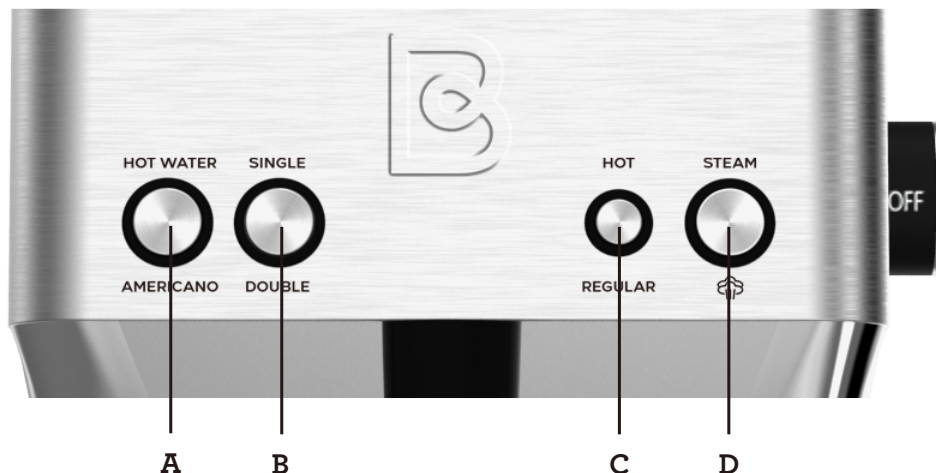

A: HOT WATER Button: Press once to make hot water;
 Press Twice to make a Americano(6Oz);
 Press and hold for 5 seconds to start descaling;
 To stop the process, press once again;

B: Espresso Button: Press once to start brewing a single espresso;
 Press twice to start brewing a double espresso;
 To stop the process, press once again;
 Press and hold for 5 seconds to customize the volume of espresso(espresso only,not Americano);

C: Espresso Temp Button: Press to select from Regular(Warm) and Hot;
 White indicator = Regular(Warm);
 Green indicator = Hot;

D: Steam Button: Press to enter/exit steam mode;

Operation & Result Function Buttons	Press once		Press twice		Press and hold for 5 seconds	
	Result	Indicator	Result	Indicator	Result	Indicator
Hot Water Button	Making hot water	Flashing in white	Making a Americano	Flashing in Green	Start descaling process	Flashing in White and Green alternately
Espresso Butoon	Brewing a single espresso	Flashing in white	Brewing a double espresso	Flashing in Green	Customize the volume of espresso	Flashing in White and Green alternately

BEFORE FIRST USE

Cleaning the appliance

- * Carefully remove the machine from the packaging and remove all packaging materials.
- * Remove all accessories from the packaging and from the machine.
- * Remove the water tank.
- * Clean the water tank with the lid, the measuring spoon and the filter as well as the filter holder with warm water and some mild dish-washing liquid. After that, rinse with clear water and dry.
- * Also, wipe the casing of the espresso machine and the drip tray with the drip grid clean with a soft, damp cloth and dry all parts.
- * Make sure that the steam knob is turned off (OFF position, turn all the way in a clockwise direction).

NOTE:

The parts of the espresso machine and the accessories are not dish-washer safe.

Initial Use

- 01.** Fill the water tank with cold water up to the MAX level of the tank.
- 02.** Insert the plug into a wall outlet with suitable voltage(120V~ 60Hz).
- 03.** Press the Power button, all the button indicators turns on and the coffee machine starts to preheat automatically. Once the preheating is finished, all the buttons will light up continuously. This preheating process takes about 1 minute.
- 04.** Place a cup under the Steam Wand. Turn on the steam knob. Let the hot water flow out of the steam wand for about 10 seconds, then turn off the steam knob. This process is let the water flow into the empty pump for the first use.

NOTE:

There will be a loud noise and little shake when the machine running first time. It's normal for a 20 bar pump. The noise will be weak in the future using.

- 05.** Insert the Filter into the Filter holder. (see image.1)

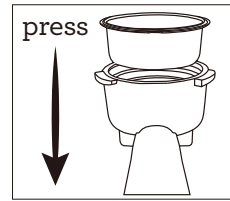

image.1

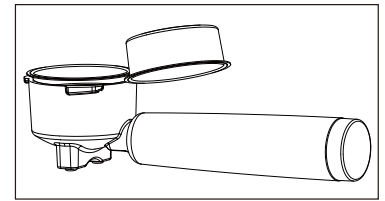

image.1.1

NOTE:

The filter might be a little tight and hard to take it out from filter holder when you want to change the filter. You can use another filter to pry it out.(see image.1.1)

- 06.** Insert the filter holder without coffee grounds into the brew head with a 45° movement to the left and turn it to the right to lock it in place.

The filter holder must be perpendicular to the machine or slightly tilted towards the right. (see image.2)

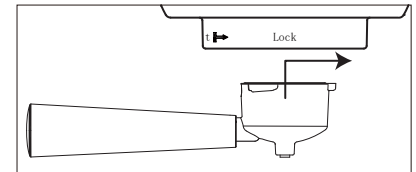

image.2

- 07.** Place an empty cup under the filter holder and press the single or double button to brew.
- 08.** After the brewing cycle has finished, pour the water out.

Now your coffee machine is ready to use.

PREPARING ESPRESSO

A cold filter holder, filter and cup can reduce the extraction temperature enough to significantly affect the quality of your espresso. **We recommend to run a brewing cycle without coffee ground to preheat them before extraction, and use hot water to warm your coffee cup.**

- 01.** Remove the filter holder and fill the filter with coffee grounds using the tamp spoon provided with the machine.
 - * We recommend 13g for single espresso and 18g for double espresso. The amount will vary depending on your preferences and the coffee grounds you used.
- 02.** Tamp the coffee grounds with the tamp spoon. The coffee grounds must be pressed evenly to obtain a well levelled and flat surface.
 - * Remove any coffee residue from the edge of the Filter Holder.
- 03.** Insert the filter holder into the brew head with a 45° movement to the left and turn it to the right to lock it in place. The filter holder must be perpendicular to the machine or slightly tilted towards the right.

SETTING THE ESPRESSO TEMPERATURE

The machine has 2 espresso temperature settings, regular(warm) and hot.

When turning on the espresso machine, the espresso temperature setting will default to the last chosen setting.

Press the Espresso TEMP button until the desired temperature is illuminated.

White Indicator = Regular

Green Indicator = Hot

MAKING ESPRESSO

- 01.** Make sure the steam knob is on “OFF” position.
- 02.** Place pre-warmed cup(s) beneath the filter holder.
- 03.** Press the Espresso button once or twice for desired volume.

The espresso button flashing in White = single espresso.

The espresso button flashing in Green = double espresso.

- 04.** The machine will stop automatically once the brewing process is finished.

The flavor of your coffee will depend on many factors, such as the type of coffee beans, degree of roast, freshness, coarseness or fineness of the grind, dose of ground coffee, and tamping pressure.

Experiment by adjusting these factors just one at a time to achieve the taste of your preference.

NOTE:

There will be noise during the operating process. This is normal for a 20 bar pump.

MAKING AMERICANO

- 01.** Remove the filter holder and fill **the double shot filter** with coffee grounds using the tamp spoon provided with the machine.
 - * We recommend 18g for double espresso. The amount will vary depending on your preferences and the coffee grounds you used.
- 02.** Tamp the coffee grounds with the tamp spoon. The coffee grounds must be pressed evenly to obtain a well levelled and flat surface.
 - * Remove any coffee residue from the edge of the Filter Holder.
- 03.** Insert the filter holder into the brew head with a 45° movement to the left and turn it to the right to lock it in place. The filter holder must be perpendicular to the machine or slightly tilted towards the right.
- 04.** Place pre-warmed cup(s) beneath the filter holder. Point hot water spout at the cup.
(see image.3.1)



image.3.1

- 05.** Make sure the steam knob is on “OFF” position.
- 06.** Press the hot water button twice. The machine will start spouting approx. 120ml water first, then brew a double espresso.

NOTE: The hot water button will flash in green when processing.

- 07.** The machine will stop automatically once the brewing process is finished.

FROTHING MILK

To prepare a traditional cappuccino or latte, we recommend:

- using cold, fresh whole milk. The density of the frothed milk will depend on the milk fat content.
- using stainless steel, circular, rounded milk jugs, narrower at the top, with a spout, necessary to make cappuccino decorations.

Before starting, it is important to slightly move the steam wand outwards in order to insert the jug directly under it and facilitate the movements required to froth the milk correctly.

Continue as follows:

- 01.** Press the steam button. The steam button will start to flash if the temperature is not high enough to make steam. Once the preheating has finished, the Steam Button will light up.
- 02.** Turn the steam knob slightly counterclockwise to eliminate any condensation from the wand then turn the knob off again. (see image.4.1-4.2)
- 03.** Place the jug, half-filled with cold milk, under the steam wand.



image.4.1



image.4.2

- 04.** Place the steam nozzle just below the surface of the milk. If it is inserted too deep, the milk will not be frothed; if it is not inserted deep enough, big bubbles will be produced and then disappear immediately. It is important to keep the Steam Tube not at the centre but close to the edge of the jug, with an appropriate angle to produce a stronger vortex. (see image.5.1-5.2)

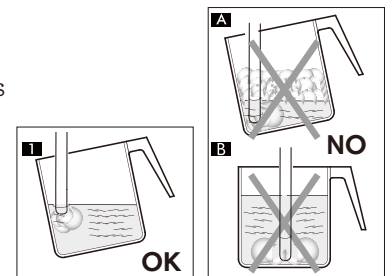

image.5.1

image.5.2

NOTE:

It is important to keep the Steam Tube not at the centre but close to the edge of the jug, with an appropriate angle to produce a stronger vortex.

- 05.** Turn the steam knob to ☁️/💧 position. The steam will come out of the steam wand.

NOTE:

The entire operation should last no longer than 3 minutes, because the machine will stop making steam automatically after 3 minutes of continuous steaming.

NOTE:

To froth the milk correctly, the steam nozzle must always be in contact with the milk and not with the froth. Therefore, as the layer of froth increases, the jug must be slightly raised trying to keep the Steam Tube in contact with the milk, without touching the bottom of the jug.

06. Once the desired frothing has been achieved, the steam nozzle must be pushed deeper to heat the milk well.

NOTE:

It is advisable to always keep a hand on the rounded part of the jug to feel the temperature increase of the unfrothed milk.

07. Once the desired result has been achieved, turn the steam knob to “OFF” position to stop dispensing steam and remove the jug.

NOTE:

To make the froth more compact, it is advisable to lightly tap the jug on a flat surface after frothing.

08. Press the steam button again to quit the steam mode. Pour the frothed milk into the coffee.

NOTE:

The machine will release some steam from the drip tray to cool down the boiler once it has been exited the steam mode. It's normal.

⚠ WARNING

The steam wand may be very hot during and after use. To avoid burns, move it only by placing your fingers on the rubber tip fitted on the steam wand.

09. Turn the steam knob on to eliminate any residue milk from the wand then turn the knob off again.

MAKING HOT WATER

- 01.** Turn the machine on and wait until all the buttons light up.
- 02.** Place a cup under the hot water wand.
- 03.** Press the hot water button once. The hot water will come out of the hot water wand.
- 04.** Once the desired amount of hot water has been dispensed, press the hot water button again.

NOTE: The entire operation should last no longer than 45 seconds, because the machine will stop making hot water automatically after 45 seconds of continuous working. If you want more hot water, run the cycle again.

NOTE: The hot water wand may be very hot during and after use. To avoid burns, move it only by placing your fingers on the rubber tip fitted on the hot water wand.

AUTO SHUT-OFF FUNCTION

If no operation is selected after 15 minutes of being powered on, the unit will power down automatically. You need to press the power button again to power on the machine.

If no operation is selected after 215ml/7.27 oz of water is pumped out(making hot water), the pump will stop automatically.

If no operation is selected after 180 seconds of frothing milk, the pump will stop automatically.

WATER SHORTAGE ALARM

The machine will detect when there is no water in the water tank. **All the four buttons will flash and no function.**

Proceed with below steps to fix it.

- 01.** Refill the water tank.
- 02.** Put a big cup under the steam wand.
- 03.** Turn the steam knob to ☁️/🔥 position. The machine will pump water through the steam wand.
- 04.** The steam button will light up and keep flashing once the machine detecting there is water in the tank.
- 05.** Return the steam knob to “OFF” position.
- 06.** All buttons will light up.

PROGRAMMING THE VOLUME OF ESPRESSO

To set the volume of single espresso

Press and hold the espresso button for 5 seconds, the espresso indicator will flash and in white and green alternately.

Press the espresso button once again, the coffee will start to dispense and the espresso indicator will flash in white at the same time.

When the desired amount is reached, press the espresso button again and the coffee will stop dispensing.

You have now programmed the machine to the volume of a single espresso as per your preferences, and this will be saved for future use.

To set the volume of double espresso

Press and hold the espresso button for 5 seconds, the espresso indicator will flash and in white and green alternately.

Press the espresso button twice again, the coffee will start to dispense and the espresso indicator will flash in green at the same time.

When the desired amount is reached, press the espresso button again and the coffee will stop dispensing.

You have now programmed the machine to the volume of a double espresso as per your preferences, and this will be saved for future use.

To reset the default volumes

Simultaneously press and hold the hot water button and espresso button for 5 seconds to restore to default volume.

CLEANING AND MAINTENANCE

Cleaning the Filter Holder and the filters

Turn the knob to OFF and allow the coffee maker to cool down completely before cleaning.

Regularly clean the casing of the coffee maker with a damp sponge, then clean the water tank, drip tray and drip plate and dry.

Cleaning the portafilter and the filters

The portafilter and filters should be kept clean to guarantee perfect results.

▲ WARNING

To avoid burns, the filter must only be removed when the portafilter has cooled down completely.

01. Remove the filter from the portafilter and wash it with warm water.
02. If you notice a malfunction when brewing coffee, immerse the filter in boiling water for 10 minutes and then rinse with running water.

NOTE: Do not clean any of the parts in the dishwasher.

Cleaning the Steam Wand

01. Immediately after frothing milk, turn steam on to purge out any residual milk from the steam wand.
02. Clean the steam wand with a damp cloth. To clean it more thoroughly, you can unscrew the Steam Tube and wash it with running water.
03. If the hole of the steam wand becomes blocked with milk residue, insert a needle into the hole of the steam wand and remove. Then run hot water through the steam wand for 4-6 seconds.(see image.6.1)

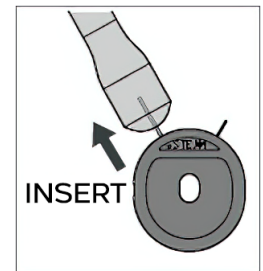

image.6.1

04. If the hole of the steam wand remains blocked. Unscrew the steam nozzle and put it into a cup of warm water with one espresso machine cleaning tablet. Rinse the steam nozzle under running water, then insert the cleaning needle into the hole and remove. Run hot water through the steam wand for 4-6 seconds. (see image.7.1-7.2)

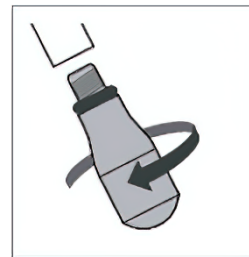

image.7.1



image.7.2

Cleaning the Brew Head

Regularly remove any residual coffee grounds from the brew head using a brush, and wash with hot water following the steps below.

- 01.** Do not insert the portafilter.
- 02.** Place an empty cup under the brew head.
- 03.** Press either the espresso button. The brewing will begin.
- 04.** The machine will stop automatically once the brewing process is finished.

⚠ WARNING Do not try to disassemble the brew head. It will damage the brew head and lead to leakage.

DESCALING THE APPLIANCE

To make sure your coffee machine operates efficiently, to clean the internal pipes, and to preserve the flavor of your coffee, the coffee machine needs to be descaled, cleaned and maintained periodically. After 500 brew cycles, a descaling warning will be shown. All indicator lights will flash 5 times to indicate it is time to descale the machine. The descaling warning will appear every time at start-up if you do not run the descaling cycle.

- 01.** Fill the water tank with water and a descaling agent (4 parts water to 1 part descaling agent) to the MAX level.

Please also refer to the instructions on the descaling agent. Please use a household descaling agent, or you can use citric acid instead of a commercial descaling agent—in this case use 100 parts of water to three parts of citric acid.

- 02.** Place a cup/mug or other suitable receptacle on the drip tray. Press and hold the HOT WATER button for 5 seconds to start the descaling cycle. The descaling cycle will process for 7 minutes then the machine will stop automatically. Then turn off the machine and leave the descaling solution in the machine for 5 minutes.
- 03.** Turn on the machine again and repeat the previous step three more times.
- 04.** Next, repeat the process two more times using only CLEAN TAP WATER without any descaling agent.

TROUBLESHOOTING

PROBLEM	POSSIBLE CAUSE	SOLUTION
Machine does not work, or could not turn on.	Machine is not switched on or power plug is not plugged in.	Make sure that the power plug is plugged in, that the ON/OFF button has been pressed and that both coffee buttons light up blue.
	Short circuit / power outlet is without power.	Check the power supply.
	The machine is faulty.	Contact our customer support.
Machine does not work, and all buttons are flashing at the same time.	Water tank is empty, and the machine is under the water shortage protection.	Fill the water tank, then use hot water function to pump the water until the machine go back to standby mode.
	The machine is faulty.	Contact our customer support.
Machine does not work, only the hot water button and espresso button are flashing at the same time.	The NTC inside is broken.	Contact our customer support.
Coffee does not or only slowly run out of the portafilter.	Water tank is empty.	Fill water tank.
	The water tank is not installed correctly.	Remove the water tank and correctly install it.
	The machine cannot pump the water.	Use hot water function to pump the water.
	Coffee is ground too finely.	Ensure appropriate amount.
	Too much coffee in filter.	Ensure appropriate amount.
	Ground coffee is tamped too strongly.	Tamp ground coffee less strongly.
	Filter is clogged up.	Clean the filters hole with a pin.
	The steam button is turn on(after using the hot water function and without turn off).	Turn the steam button off.
	The machine is faulty.	Contact our customer support.
Coffee runs through too quickly.	Coffee is ground too coarsely.	Ensure appropriate degree of grinding.
	Too little coffee in filter.	Ensure appropriate amount.
	Ground coffee is not tamped strong enough.	Tamp ground coffee more strongly.

Coffee is not enough hot.	Machine is not pre-warmed.	Let hot water run through the appliance with the inserted portafilter (with filter but without coffee grounds) before extracting the first coffee to warm up the brew system.
	Cups not pre-warmed.	Pre-warm cups with warm water.
Water is pooled under the coffee machine.	The water tank is not installed correctly.	Remove the water tank and correctly install it.
	The drip tray is filled with water.	Empty and clean drip tray.
	The machine is faulty.	Contact our customer support.
The steam fails to steam the milk.	The milk jug is too big or the jug shape is unsuitable.	Always use a tall, slim container ideally made from stainless steel.
	You have used milk with less than 3.3% of milk protein.	Use milk with more than 3.3% of milk protein.
	The milk is not cold.	Always use cold milk(41°F).
Not producing steam.	Water tank is empty.	Fill the water tank.
	Steam nozzle is clogged.	Remove the steam nozzle from steam wand and clean the steam nozzle with a pin.
	Steam function was used for more than 3 minutes.	Turn steam knob off for at least 1 minute.
	The machine is faulty.	Contact our customer support.
Hot water function is not working.	Water tank is empty.	Fill the water tank.
	Hot water function was used for more than 45 seconds.	Turn steam knob off for at least 1 minute.
	The machine is faulty.	Contact our customer support.
Coffee is dripping out of the rim of the portafilter.	Too much coffee in the filter.	Make sure to use the correct amount of coffee.
	Coffee ground is sticking to the sealing ring of the brewing head.	Turn off the machine, wait until it has cooled down and then clean the filter, the portafilter and the brew head with its sealing ring.
	The sealing ring is not assembled well or broken.	Check the sealing ring and contact our customer support.
	portafilter is not completely closed.	Insert the portafilter and turn the handle to the right until you feel some resistance.

NOTE:

If your problem is not listed, please contact Customer Support.

WARRANTY INFORMATION

The manufacturer provides warranty in accordance with the legislation of the customer's own country of residence, with a minimum of 12 months, starting from the date on which the appliance is sold to the end user.

The warranty only covers defects in material or workmanship.

The warranty will not apply in cases of:

- Normal wear and tear.
- Incorrect use, e.g. overloading of the appliance, use of non-approved accessories.
- Use of force, damage caused by external influences.
- Damage caused by non-observance of the user manual, e.g. connection to an unsuitable mains supply or non-compliance with the installation instructions.
- Partially or completely dismantled appliances.

CUSTOMER SUPPORT

If you have any questions or concerns about your new product, please contact our helpful Customer Support Team. Contact our team by email:

Support@CASABREWS.com

Scan the QR code, register your product, and get a **6-month Extended Warranty and operation video!**



* Please have your invoice and order ID ready before contacting Customer Support.



CASABREWS BRANDS INC.

1360 S Valley Vista Dr. , Suite 108

Diamond Bar, California 91765

United States of America

support@casabrews.com

www.casabrews.com

CASABREWS