

CASABREWS

INSTRUCTION MANUAL

Espresso Coffee Machine

Model: 3700 PRO



Scan the QR code for
bonus warranty.

support@casabrews.com

HOUSEHOLD USE ONLY

Please read all instructions carefully before using the product

Contents

Important Safeguards	1-2
Specifications	2
Know Your Coffee Machine	3
Control Panel	4
Before First Use	5-6
Preparing the Espresso	6-7
Making the Espresso	7
Espresso Pressure Gauge	8-9
Frothing Milk	8-9
Making Cappuccino	9-10
Making Latte	11
Add Additional Frothed Milk/Frothing Milk Manually	11
Customize The Volume of Espresso, Cappuccino and Latte	12-13
Resetting Default Volumes	14
Water Shortage Alarm	14
Auto Shut-off	14
Cleaning and Maintenance	15-16
Cleaning The Water Tank	17
Descaling	17-18
Trouble Shooting	19-20
Warranty Information	21
Customer Support	21

Important Safeguards

When using electrical appliances, basic safety precautions should always be followed to reduce the risk of fire, electric shock and/or injury to persons, including the following:

- 01.** Do not touch hot surfaces. Use handles or knobs.
- 02.** To protect against electric shock, do not immerse cord, plug or appliance in water or other liquids.
- 03.** Unplug unit from electrical outlet when not in use and before cleaning. Allow it to cool before putting on or taking off parts and before cleaning it.
- 04.** Do not operate any appliance with a damaged cord or plug or after the appliance malfunctions or has been damaged in any manner. Return this appliance only to the nearest authorized service center for examination, repair or adjustment. Do not attempt to replace or splice a damaged cord.
- 05.** The use of an accessory not recommended by the appliance manufacturer for use with this appliance may result in fire, electric shock or injury to persons.
- 06.** Do not use outdoors or for commercial purposes.
- 07.** Do not let cord hang over edge of table or countertop or touch hot surfaces.
- 08.** Do not place this appliance on or near a hot gas or electric burner or in a heated oven.
- 09.** To disconnect, press the Power button off and then remove plug from outlet.
- 10.** Do not use appliance for anything other than its intended use.
- 11.** Use on a hard, flat level surface only, to avoid interruption of airflow underneath the appliance.
- 12.** Always be sure to place the water reservoir back on the unit tightly with the lid closed and water filled up to, but not surpassing, the MAX line.
- 13.** Do not remove the portafilter while brewing coffee. Please make sure the three lights are on before you remove the portafilter to make additional coffee. Caution should also be taken while removing the portafilter since the metal parts will be hot. Please make sure to hold it by the handle. Caution should be taken when moving unit with hot liquids.
- 14.** Do not remove the water reservoir or milk reservoir until the unit has stopped brewing and/or frothing.

15. This appliance is not to be used by children or by persons with reduced physical, sensory or mental capabilities.
16. Close supervision is necessary when any appliance is used near children. Children should not play with the appliance.

SAVE THESE INSTRUCTIONS FOR HOUSEHOLD USE ONLY

Specifications

Model:	3700 PRO
Voltage:	120V~ 60Hz
Power:	1350W
Espresso Pressure:	20 Bar
Capacity of Water Tank:	1.3 L / 43.9 OZ
Capacity of Milk Reservoir:	500 ML / 16.9OZ
Product Size:	12.99 * 8.49 * 12.13 IN
Product Weight:	10.45 LBS

Know Your Coffee Machine

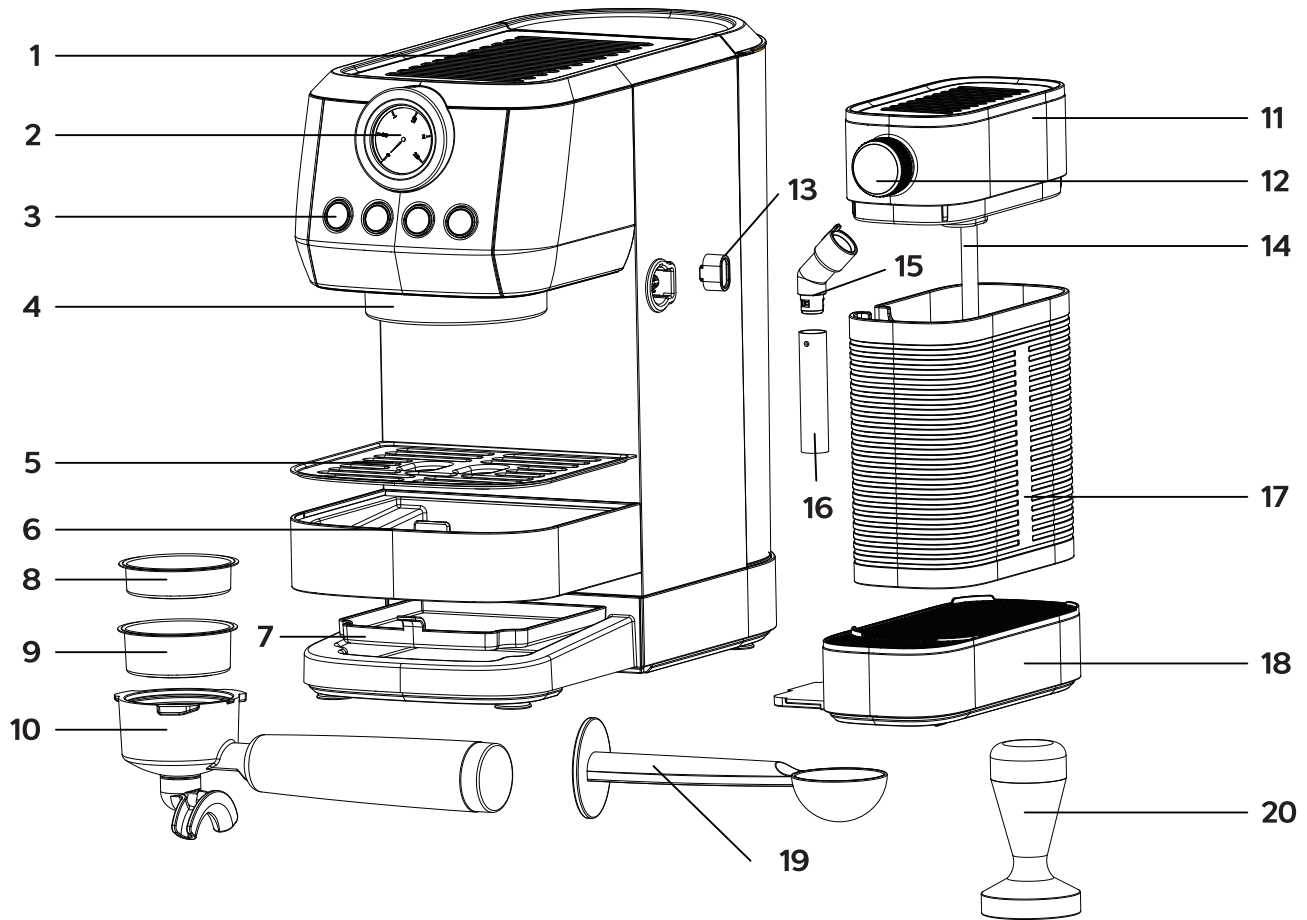

1. Cup Warmer
2. Pressure Gauge
3. Control Panel
4. Brew Head
5. Drip Tray Grid
6. Drip Tray
7. Inner Drip Tray
8. Single Shot Filter
9. Double Shot Filter
10. Filter Holder/Portafilter

11. Milk Reservoir Lid
12. Milk Knob
13. Locker of Milk Reservoir
14. Silicon Tube
15. Connector of Milk Dispensing Tube
16. Milk Dispensing Tube
17. Milk Reservoir
18. Milk Reservoir Plate
19. Spoon
20. Tamper

Control Panel

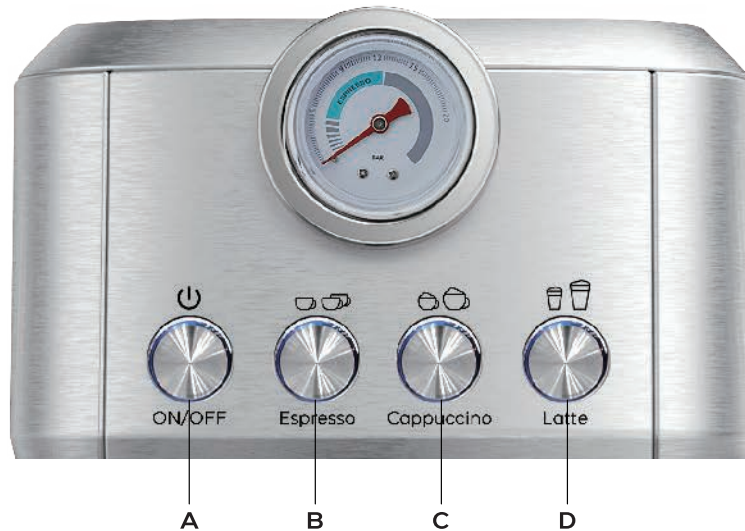

A: Power ON/OFF Button: Press to turn on/off the machine.

B: Espresso Button: Press once to brew a single shot of espresso
 Press twice to brew double shots of espresso
 Press and hold for 3 seconds to customize the volume of Espresso, Cappuccino and Latte

C: Cappuccino Button: Press once to brew a small cup of cappuccino
 Press twice to brew a large cup of cappuccino
 Press and hold for 3 seconds to frothing milk manually

D: Latte Button: Press once to brew a small cup of latte
 Press twice to brew a large cup of latte
 Press and hold for 3 seconds to run the cleaning cycle of milk-frothing system

Operation & Result Function Buttons	Press once			Press twice		
	Cup Size	Indicator	Default volume	Cup Size	Indicator	Default volume
Espresso	Single Shot	Flash in Blue	35ml/1.18oz	Double Shots	Flash in Green	70ml/2.37oz
Cappuccino	Small Cup	Flash in Blue	170ml/5.75oz	Large Cup	Flash in Green	285ml/9.64oz
Latte	Small Cup	Flash in Blue	340ml/11.5oz	Large Cup	Flash in Green	425ml/14.37oz

Before First Use

Cleaning The Appliance

- * Carefully remove the appliance from the packaging and remove all packaging materials.
- * Remove all accessories from the packaging and from the appliance.
- * Remove the water tank.
- * Clean the water tank with the lid, the milk reservoir with lid, the measuring spoon and the filters as well as the filter holder with warm water and some mild dish-washing liquid. After that, rinse with clear water and dry.
- * Also, wipe the casing of the espresso machine and the drip tray with the drip grid clean with a soft, damp cloth and dry all parts.
- * Make sure that the milk reservoir is assembled well.

NOTE: The filter holder and filters are not dish-washer safe.

Initial Use

- 01.** Fill the water tank and the milk reservoir with cold water up to the MAX level of the tank.
- 02.** Insert the plug into a wall outlet with suitable voltage(120V~, 60Hz).
- 03.** Press the Power button, the Power indicator light turns on and the coffee machine starts to preheat automatically. Once the preheating is finished, all the buttons will light up continuously. This preheating process takes about 2 minutes.
- 04.** Place a cup under the brew head. Turn the milk knob point at the cup. press and hold the Latte button for 3 seconds. The machine will start to make hot water from the milk tube. Let the hot water flow out of the milk tube for about 8 seconds, then press the Latte button again to stop. This process is let the water flow into the empty pump for the first use.

NOTE: There will be a loud noise and little shake when the machine running first time. It's normal for a 20 bar pump. The noise will be weak in the future using.

05. Insert the Filter into the Filter holder.
06. Insert the filter holder without coffee grounds into the brew head with a 45° movement to the left and turn it to the right to lock it in place.

The filter holder must be perpendicular to the machine or slightly tilted towards the right. (see image.1)

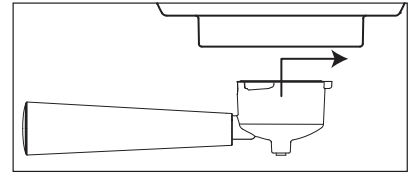

image.1

07. Place a empty cup under the filter holder and press the Espresso button once to brew.
08. After the brewing cycle has finished, pour the water out.

Now your coffee machine is ready to use.

Preparing the Espresso

A cold filter holder, filter and cup(s) can reduce the extraction temperature enough to significantly affect the quality of your espresso. We recommend to run a brewing cycle without coffee grounds to preheat them before extraction(see steps 5-8 of **Initial Use**).

01. Select the filter to be used as follows: (see image.2)

- * For a single shot: use the filter for a single shot of espresso if using ground coffee.
- * For a single shot: use the filter for a single shot of espresso if using ground coffee.

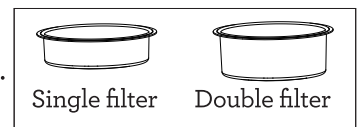

image.2

02. Insert the filter into to the filter holder.

- * To insert the selected filter in the filter holder, press the filter down into the filter holder. (see image.3)
- * The filter might be a litter tight and hard to take it out from filter holder when you want to change the filter. You can use another filter to pry it out. (see image.4)

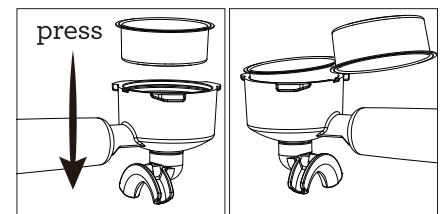

image.3

image.4

- 03.** Fill the filter with coffee grounds using the tamp spoon provided with the machine.
 - * **We recommend 7-9g for single shot and 13-15g for double shot.** The amount will vary depending on your preferences and the coffee grounds you used.
- 04.** Tamp the coffee grounds with the tamper. The coffee grounds must be pressed evenly to obtain a well levelled and flat surface.
 - * Remove any coffee residue from the edge of the filter holder.
- 05.** Insert the filter holder into the brew head with a 45° movement to the left and turn it to the right to lock it in place. The filter holder must be perpendicular to the machine or slightly tilted towards the right.

Making the Espresso

- 01.** Place pre-warmed cup(s) beneath the filter holder.
- 02.** Press the Espresso button once for a single shot. The Espresso button will flash in blue when brewing.
- 03.** Press the Espresso button twice for double shots. The Espresso button will flash in green when brewing.
- 04.** The machine will start brewing the espresso according to your selection. The machine will turn off automatically and the button will become solid indicating that the cycle has been completed. Your delicious espresso is ready to be enjoyed.

* The flavor of your coffee will depend on many factors, such as the type of coffee beans, degree of roast, freshness, coarseness or fineness of the grind, dose of ground coffee, and tamping pressure. Experiment by adjusting these factors just one at a time to achieve the taste of your preference.

NOTE: There will be noise during the operating process. This is normal for a 20 bar pump.

NOTE: To brew less coffee than the preset serving, press the Espresso button to stop the brewing process when the amount of coffee desired is reached.

Espresso Pressure Gauge

The gauge needle indicates the extraction pressure.

Ideal Espresso Zone

When it is positioned anywhere in espresso range during extraction, it means the espresso has been extracted at the ideal pressure. (see image.5)

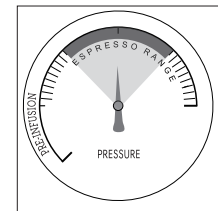

image.5

Low pressure zone

When the gauge needle is under the espresso range zone during extraction, this indicates the espresso has been extracted with insufficient pressure.

This can happen when the water flow through the ground coffee is too fast, resulting in an under extracted espresso that is watery, clod and lacks crema and flavor.

Possible causes for under extraction include: the grind being too coarse, insufficient coffee in the filter, insufficient tamping, or a combination of any of these. (see image.6)

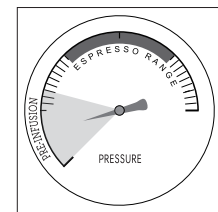

image.6

To resolve this:

- 01. Select a finer grind setting and retry.**
- 02. Increase the amount of coffee grounds and retry.**
- 03. Increase the tamping pressure and retry.**

High pressure zone

When the gauge needle is above the espresso range zone during extraction, this indicates the espresso has been extracted with too much pressure.

This can happen when the water flow through the ground coffee is too slow and results in an over extracted espresso that is very dark and bitter with a mottled and uneven crema.

Possible causes for over extraction include: the grind being too fine, too much ground coffee in the filter, over tamping or a combination of any of these. (see image.7)

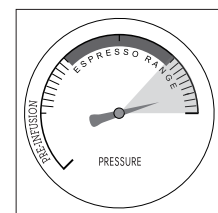

image.7

To resolve this:

- 01. Select a coarser grind setting and retry.**
- 02. Decrease the amount of coffee grounds and retry.**
- 03. Decrease the tamping pressure and retry.**

		GRIND	Amount of Coffee Ground	TAMP	SHOT TIME
OVER EXTRACTED	CAUSE	TOO FINE	TOO MUCH	TOO HEAVY	OVER 50 SEC
	SOLUTION	Grind coarser	Decrease the amount	Decrease the strength	
IDEAL EXTRACTION		OPTIMUM	7-9g (Single shot) 13-15g (Double shot)	20-33lbs (9-15kg)	25-45 SEC
UNDER EXTRACTED	CAUSE	TOO COARSE	TOO LITTLE	TOO LIGHT	UNDER 20 SEC
	SOLUTION	Grind finer	Increase the amount	Increase the strength	

Making Cappuccino

01. Push the locker to “unlock” position. (see image.8)

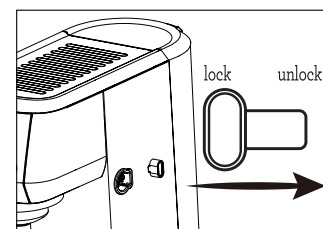

image.8

02. Use two hands to hold the milk reservoir with the lid, then take it out of the machine. (see image.9)

The Cappuccino and Latte button will turn off indicating the milk reservoir is unconnected. (see image.10)

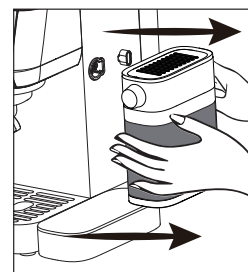

image.9

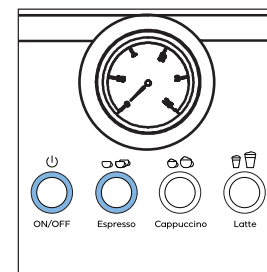

image.10

Attention: Do not just use one hand to hold the milk reservoir or the lid only. The milk reservoir may fall off.

03. Open the lid and fill the milk reservoir with cold whole milk(39-41°F).
04. Close the lid. Use two hands to hold the milk reservoir with the lid, then insert it into the coffee machine.

Attention: Do not just use one hand to hold the milk reservoir or the lid only. The milk reservoir may fall off.

05. Push the locker to “Lock” position. The Cappuccino and Latte button will turn on and flash in blue indicating the machine is starting to preheat.
06. Place pre-warmed cup(s) beneath the filter holder.

CAUTION: When brewing cappuccino or latte, make sure to adjust the milk knob to aim the milk dispensing tube inside your cup. (see image.11)

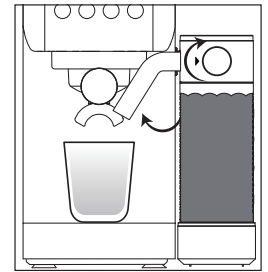

image.11

07. Press the Cappuccino button once to brew a small cup of cappuccino. The Cappuccino button will flash in blue when brewing. (see image.12)
08. Press the Cappuccino button twice to brew a large cup of cappuccino. The Cappuccino button will flash in green when brewing. (see image.13)

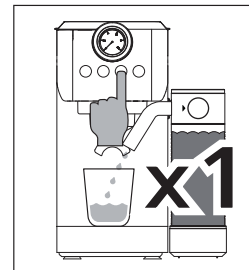

image.12

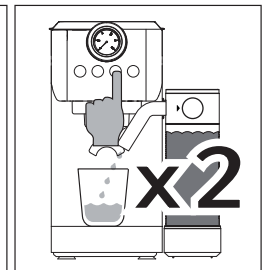

image.13

09. The machine will start brewing the espresso according to your selection. The machine will turn off automatically and the button will become solid indicating that the cycle has been completed. Your delicious espresso is ready to be enjoyed.

NOTE: For a small cup, use the single shot filter. For a large cup, use the double shot filter.

IMPORTANT: Make sure to clean the milk dispensing tube after use. See Cleaning instructions on page 15-16 for instructions.

Making Latte

Follow the steps 1–6 of **Making Cappuccino**.

- 01.** Press the Latte button once to brew a small cup of latte.
The Latte button will flash in blue when brewing. (see image.14)
- 02.** Press the Latte button twice to brew a large cup of latte.
The Latte button will flash in green when brewing. (see image.15)
- 03.** The machine will start brewing the espresso according to your selection. The machine will turn off automatically and the button will become solid indicating that the cycle has been completed.
Your delicious espresso is ready to be enjoyed.

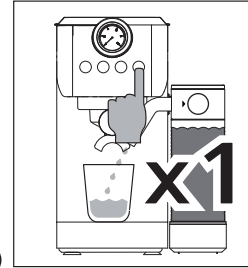

image.14

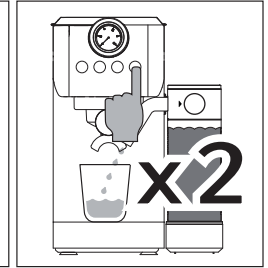

image.15

NOTE: For a small cup, use the single shot filter. For a large cup, use the double shot filter.

IMPORTANT: Make sure to clean the milk dispensing tube after use. See Cleaning instructions on page 15-16 for instructions.

Add Additional Frothed Milk/Frothing Milk Manually

This machine also allows you to manually add more frothed milk to your beverage or froth milk separately.

- 01.** Place your beverage or a empty cup beneath the brew head.
Make sure the milk dispensing tube is point at the cup.
- 02.** Press and hold the Cappuccino button for 3 second, the machine will start to Frothing the milk. The Cappuccino button will flash in blue and green alternately.
(see image.16)
- 03.** When done, press the Cappuccino button again to stop.

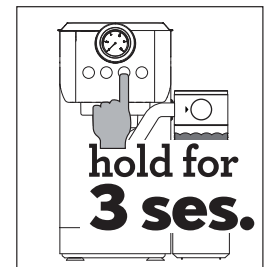

image.16

Customize The Volume of Espresso, Cappuccino and Latte

This machine allows you to customize the volume of Espresso, Cappuccino and Latte as you desired.

Customize the volume of Espresso

When the machine finished preheating, press and hold the Espresso button for 3 seconds. The Espresso, Cappuccino, and Latte buttons will flash alternately in green indicating the machine is ready to customize the volume(if no operation for 15 seconds, the machine will be back to standby mode).

- 01.** To customize the volume of single shot espresso, press the Espresso button once. The machine will beep three times and start brewing coffee.
- 02.** To customize the volume of double shots espresso, press the Espresso button twice. The machine will beep three times and start brewing coffee.
- 03.** When the desired amount is reached, press the Espresso button again to stop. The machine will beep three times indicating that the volume has been customized successfully, then back to standby mode.

NOTE: The adjustable volume ranges between 20ml/0.7oz to 200ml/7oz.

Customize the volume of Cappuccino

When the machine finished preheating, press and hold the Espresso button for 3 seconds. The Espresso, Cappuccino, and Latte buttons will flash alternately in green indicating the machine is ready to customize the volume(if no operation for 15 seconds, the machine will be back to standby mode).

- 01.** To customize the volume of small cup cappuccino, press the Cappuccino button once. The machine will beep three times and start frothing milk.
- 02.** To customize the volume of large cup cappuccino, press the Cappuccino button twice. The machine will beep three times and start frothing milk.
- 03.** When the desired amount of frothed milk is reached, press the Cappuccino button again. The machine will start brewing espresso automatically.
- 04.** When the desired amount of espresso is reached, press the Cappuccino button once again to stop. The machine will beep three times indicating that the volume has been customized successfully, then back to standby mode.

NOTE:

The adjustable time of milk frothing ranges between 6 seconds to 60 seconds. The adjustable volume of espresso ranges between 20ml/0.7oz to 200ml/7oz.

Customize the volume of Latte

When the machine finished preheating, press and hold the Espresso button for 3 seconds. The Espresso, Cappuccino, and Latte buttons will flash alternately in green indicating the machine is ready to customize the volume(if no operation for 15 seconds, the machine will be back to standby mode).

- 01.** To customize the volume of small cup latte, press the Latte button once. The machine will beep three times and start frothing milk.
- 02.** To customize the volume of large cup latte, press the Latte button twice. The machine will beep three times and start frothing milk.
- 03.** When the desired amount of frothed milk is reached, press the Latte button again. The machine will start brewing espresso automatically.
- 04.** When the desired amount of espresso is reached, press the Latte button once again to stop. The machine will beep three times indicating that the volume has been customized successfully, then back to standby mode.

NOTE:

The adjustable time of milk frothing ranges between 6 seconds to 60 seconds.
The adjustable volume of espresso ranges between 20ml/0.7oz to 200ml/7oz.

Resetting Default Volumes

To reset the machine to the default volumes of Espresso, Cappuccino and Latte, press and hold the Espresso and Cappuccino buttons together for 5 seconds. The machine will return to its original default settings.

Water Shortage Alarm

For the water shortage alarm, the Espresso, Cappuccino and Latte buttons flash in green simultaneously.

Once the water shortage alarm is emitted, please proceed as follows:

- 01.** Refill the water tank with room temperature water.
- 02.** Place a empty cup beneath the brew head, and aim the milk dispensing tube into the empty cup.
- 03.** Press any one button of the Espresso, Cappuccino, and Latte buttons. The machine will start to pump water and make hot water.
- 04.** Once the hot water come out of the milk dispensing tube, all the buttons will fully illuminate. Now the machine is ready to use again.

Auto Shut-off

The machine will shut off automatically if no operation for 15 minutes on standby mode. All the button will turn off. To start the machine, press the Power button again.

Cleaning and Maintenance

Regular cleaning and maintenance keep the machine in working condition and ensure perfect coffee flavour, a constant coffee flow, and excellent milk froth for a long period of time.

Cleaning The Milk Reservoir and Milk Dispensing Tube

Once you are done making your beverage with milk, you can either store the milk reservoir with milk directly in the refrigerator or completely clean the milk reservoir and milk dispensing tube.

It is important to clean the milk-frothing system immediately after making cappuccino, latte or frothing milk manually.

The milk-frothing system could get blocked by the milk residue left causing less or no milk foam created, which will badly influence coffee flavor or even make an unfavorable smell.

If storing your milk reservoir with milk in refrigerator, follow the cleaning cycle instructions:

- 01.** Place a large empty cup under the frothing tube and make sure there is water in the water reservoir.
- 02.** Aim the milk dispensing tube into the empty cup.
- 03.** Press and hold the Latte button for 3 seconds. The machine will start to make hot water from the milk dispensing tube.
- 04.** This clean cycle will run for 35 seconds and then stop automatically.
- 05.** You can repeat steps 1-4 to make sure the residue milk is cleaned completely.
- 06.** The milk dispensing tube is now clean and the milk reservoir with milk can now be stored in the refrigerator.

If completely cleaning milk reservoir, follow the deep cleaning cycle instructions:

- 01.** Place a large empty cup under the frothing tube and make sure there is water in the water reservoir.
- 02.** Remove milk reservoir from machine and discard any remaining milk. Fill the milk reservoir with clean water.
- 03.** Aim the milk dispensing tube into the empty cup.

04. Press and hold the Latte button for 3 seconds. The machine will start to make hot water from the milk dispensing tube. The clean cycle will run for 35 seconds and then stop automatically.
05. Press and hold the Cappuccino button for 3 seconds. The machine will start to make steam from the milk dispensing tube. This process will run for 2 minutes and then stop automatically.
06. You can repeat steps 1-5 to make sure the residue milk is cleaned completely.
07. Rinse and wash all parts of the milk reservoir container and lid thoroughly with warm soapy water. Rinse and dry well. Do not use abrasive cleaners and scouring pads, as they will scratch the finish. The milk reservoir and lid is also dishwasher safe.

Cleaning the Filter Holder and the Filters

The filter holder and filters should be kept clean to guarantee perfect results.

WARNING: To avoid burns, the filter must only be removed when the filter holder has cooled down completely.

01. Remove the filter from the filter holder and wash them with warm water.
02. If you notice a malfunction when brewing coffee, immerse the filter in boiling water for 10 minutes and then rinse with running water.

NOTE: Do not clean the filter holder and filters in the dishwasher.

Cleaning the Brew Head

Regularly remove any residual coffee grounds from the brew head using a brush, and wash with hot water following the steps below.

01. Insert the filter holder into the brew head without using coffee grounds.
02. Place an empty cup under the brew head.
03. Press the double button and fill the cup with water.
04. Remove the filter holder from the brew head and clean the brew head with a dry cloth.

WARNING: Do not try to disassemble the brew head. It will damage the Brew Head and lead to leakage.

Cleaning The Water Tank

Discard the remaining water by removing the water tank and turning it upside down over the sink.

It is recommended to empty the water tank between uses. Wash the water tank with soapy water, rinse it well and wipe it dry.

NOTE: Do not wash the water tank in the dishwasher.

Descaling

To make sure your coffee maker operates efficiently, to clean the internal pipes, and to preserve the flavor of your coffee, the coffee machine needs to be descaled, cleaned and maintained periodically.

Also, after 500 times of brew cycle, a descaling warning will be shown. The Power button will flash 5 times to indicate it is time to descale the machine. The descaling warning will appear at every time start-up if you do not run a descaling cycle.

However, the frequency of cleaning depends upon the hardness of the water used. The following table gives the suggested cleaning intervals.

Type of Water	Cleaning Frequency
Soft Water (Filtered Water)	Every 100 Brew Cycles
Hard Water (Tap Water)	Every 50 Brew Cycles

Please proceed as below steps to descaling the machine:

- 01.** Fill the water with descaling agent(4 parts water to 1 part descaling agent) into the water tank up to the Max marking.

NOTE: Please also refer to the instructions on the descaling agent. Please use a household descaling agent, or you can use citric acid instead of a commercial descaling agent - in this case use 100 parts of water to three parts of citric acid.

- 02.** Place a empty cup or other suitable receptacle on the drip tray.

- 03.** Press and hold the Cappuccino and Latte button together for 5 seconds. The machine will start the descaling cycle, and the descaling cycle will run 6 minutes then stop automatically. (see image.17)

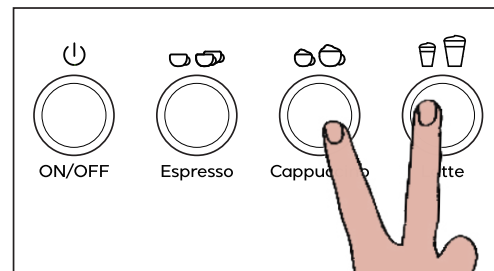

image.17

- 04.** Repeat the previous steps until the water with descaling agent is running out.
- 05.** Next, repeat the process two more times using only CLEAN TAP WATER without any descaling agent.

Trouble Shooting

Problem	Possible cause	Solution
Machine doesn't work.	Machine is not switched on or power plug is not plugged in.	Make sure that the power plug is plugged in, that the ON/OFF button has been pressed and that both coffee buttons light up blue.
	Short circuit / power outlet is without power.	Check the power supply.
	The machine is faulty.	Contact our customer support.
Coffee does not run out of the filter holder.	Water tank is empty.	Fill water tank.
	The water tank is not installed correctly.	Remove the water tank and correctly install it.
	The machine cannot pump the water.	Press and hold the Latte button for 3 seconds to run the cleaning cycle. This process will help the machine to pump the water.
	Filter is clogged up.	Clean the filters hole with a pin.
	The machine is faulty.	Contact our customer support.
Coffee only slowly run out of the filter holder.	Coffee is ground too finely.	Ensure appropriate degree of grinding.
	Too much coffee in filter.	Ensure appropriate amount.
	Ground coffee is tamped too strongly.	Tamp ground coffee less strongly.
	Filter is clogged up.	Clean the filters hole with a pin.
Coffee runs through too quickly	Coffee is ground too coarsely.	Ensure appropriate degree of grinding.
	Too little coffee in filter.	Ensure appropriate amount.
	Ground coffee is not tamped strong enough.	Tamp ground coffee more strongly.
Coffee is cold.	Machine is not pre-warmed.	Let hot water run through the appliance with the inserted portafilter (with filter but without coffee grounds) before extracting the first coffee to warm up the brew system.
	Cups not pre-warmed.	Pre-warm cups with warm water.
Coffee is too weak.	Using single filter for double shot of espresso.	Use double filter for double shot of espresso.
	The amount of coffee grounds is too less.	Increase the amount of coffee grounds.
	Ground coffee is too coarse.	Use a finer grind.

Water is pooled under the coffee machine.	The water tank is not installed correctly.	Remove the water tank and correctly install it.
	The drip tray is filled with water.	Empty and clean drip tray
	The machine is faulty.	Contact our customer support.
Coffee is dripping out of the rim of the filter holder.	Too much coffee in the filter.	Make sure to use the correct amount of coffee.
	Coffee ground is sticking to the sealing ring of the brewing head.	Turn off the machine, wait until it has cooled down and then clean the filter, the filter holder and the brew head with its sealing ring
	Filter holder is not completely closed.	Insert the filter holder and turn the handle to the right until you feel some resistance.
	The machine is faulty.	Contact our customer support.
The Cappuccino and Latte button indicators do not illuminate .	The milk reservoir is not inserted.	Insert the milk reservoir into the machine, and push the locker to "Lock" position.
	The milk reservoir is not fully inserted.	If the milk reservoir is on unit, push it in firmly and push the locker to "Lock" position until Cappuccino and Latte button indicators illuminate.
	The machine is faulty.	Contact our customer support.
The Espresso, Cappuccino, and Latte buttons are flashing in green.	Water tank is out of water	Refill the water tank with water. Press any on button of the three buttons.
Milk is not foamy after frothing or it is not coming out of the frothing tube.	Ran out of steam.	Make sure there is enough water in the water tank.
	Milk is not cold enough.	Chill milk and frothing pitcher prior to making cappuccino or latte.
	Frothing tube is blocked.	Follow the instructions to clean the milk reservoir & frothing tube.
The volume of Cappuccino or Latte that comes out is different every time.	Frothing tube is blocked.	Follow the instructions to clean the milk reservoir & frothing tube.
Bad smell comes out of the milk tube.	There are some residue milk in the milk-frothing system.	Follow the instructions to clean the milk reservoir & frothing tube in time.

NOTE:

If your problem is not listed, please contact Customer Support.

Warranty Information

The manufacturer provides warranty in accordance with the legislation of the customer's own country of residence, with a minimum of 12 months, starting from the date on which the appliance is sold to the end user.

The warranty only covers defects in material or workmanship.

The warranty will not apply in cases of:

- Normal wear and tear.
- Incorrect use, e.g. overloading of the appliance, use of non-approved accessories.
- Use of force, damage caused by external influences.
- Damage caused by non-observance of the user manual, e.g. connection to an unsuitable mains supply or non-compliance with the installation instructions.
- Partially or completely dismantled appliances.

Customer Support

If you have any questions or concerns about your new product, please contact our helpful Customer Support Team.

Contact our team by email:

Support@CASABREWS.com

Or scan the QR code for an additional barista book and more support.



* Please have your invoice and order ID ready before contacting Customer Support.



CASABREWS BRANDS INC.

1360 S Valley Vista Dr., Suite 108

Diamond Bar, California 91765

United States of America

support@casabrews.com

www.casabrews.com

CASABREWS