

CASABREWS

INSTRUCTION MANUAL

Espresso Coffee Machine

Model: 3700 GENSE



Scan the QR code for
bonus warranty.

support@casabrews.com

HOUSEHOLD USE ONLY

Please read all instructions carefully before using the product

Contents

Important Safeguards	1-2
Specifications	2
Know Your Coffee Machine	3
Control Panel	4
Before First Use	5-6
Preparing the Espresso	7
Making the Espresso	7
Making the Espresso	7
Frothing Milk	8-9
Making Hot Water	10
Espresso Pressure Gauge	10-12
Ideal Espresso Zone	10
Low pressure zone	10-11
High pressure zone	12
Setting the Volume of Single and Double shot	12
Resetting Default Volumes	13
Cleaning and Maintenance	13
Cleaning the Filter Holder and the filters	13
Cleaning the Steam Wand	14
Cleaning the Brew Head	14
Descaling	15
Trouble Shooting	16-17
Warranty Information	18
Customer Support	18

Important Safeguards

- 01.** This appliance is not intended for use by persons (including children) with reduced physical, sensory or mental capabilities, or lack of experience and knowledge, unless they have been given supervision or instruction concerning use of the appliance by a person responsible for their safety.
- 02.** Children should be supervised to ensure that they do not play with the appliance.
- 03.** This appliance can be used by children aged from 8 years and above and persons with reduced physical, sensory or mental capabilities or lack of experience and knowledge if they have been given supervision or instruction concerning use of the appliance in a safe way and understand the hazards involved. Children shall not play with the appliance.
- 04.** Check the appliance before each use and ensure that the appliance, power cord and plug are not damaged and no parts have come loose.
- 05.** If the supply cord is damaged, it must be replaced by the manufacturer, its service agent or similarly qualified persons in order to avoid a hazard.
- 06.** This appliance is intended to be used in household and similar applications such as:
 - staff- kitchen areas in shops, offices and other working environments;
 - farm houses;
 - by clients in hotels, motels and other residential type environments;
 - bed and breakfast type environments.
- 07.** The appliance must not be immersed in water.
- 08.** The heating element surface is subject to residual heat after use.
- 09.** Cleaning and user maintenance shall not be made by children without supervision.
- 10.** Never touch the hot appliance parts like the steam/hot water outlet, the metal part of the portafilter or the filter during or shortly after use. Only touch the heat insulated handles, buttons or selectors.
- 11.** Never take the portafilter off while the appliance performs a brewing process or steams milk-the appliance is pressurised!
- 12.** Never point the steam / hot water wand towards persons, animals or steam and moisture sensitive furniture! The escaping steam or the water is very hot and could cause scalding!

13. Only cups and tamper may be placed on the cup tray. Do not place any other items on the appliance.

CAUTION: After prolonged use, the cup shelf gets so hot that you might scald yourself on it!

14. Do not leave the espresso machine unattended when in use. This applies especially when children are nearby.

15. **CAUTION:** The appliance becomes very hot during use! Allow the appliance to cool down before removing or attaching parts, moving, relocating or cleaning it.

16. Oils or lubricants must not be used with this appliance.

17. Pull the plug after every use. Only then, the appliance is fully switched off.

FOR HOUSEHOLD USE ONLY.

Specifications

Model:	3700GENSE
Voltage:	120V~ 60Hz
Power:	1350W
Espresso Pressure:	20 Bar
Capacity of Water Tank:	1.3L/43.9 OZ
Product Size:	12.99*6.49*12.13 IN
Product Weight:	8.14 LBS

Know Your Coffee Machine

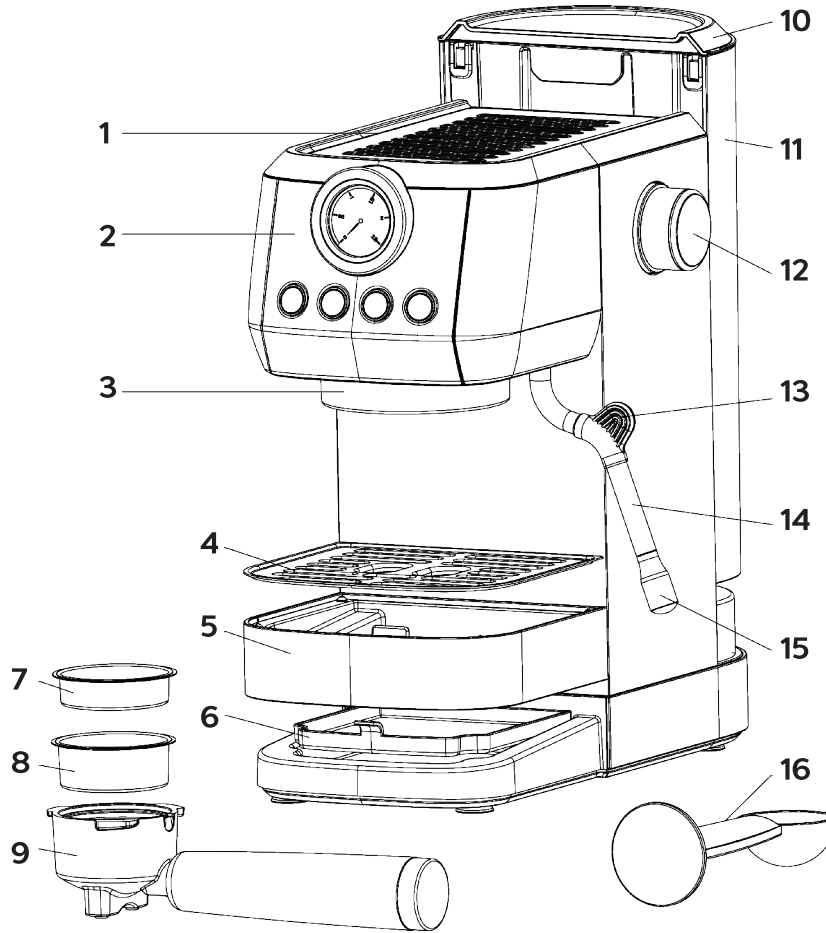

- 1. Cup Warmer
- 2. Control Panel
- 3. Brew Head
- 4. Drip Tray Grid
- 5. Drip Tray
- 6. Inner Drip Tray
- 7. Single Shot Filter
- 8. Double Shot Filter

- 9. Filter Holder
- 10. Water Tank Lid
- 11. Water Tank
- 12. Steam Knob
- 13. Thermo-insulated Handle
- 14. Steam Wand
- 15. Steam Nozzle
- 16. Measure Spoon with Tamper

Control Panel



A. 20 Bar Pressure gauge: Help to control the pressure precisely.

B. Power Button: Press to turn on/off the power.

C. Single Shot Button: Press to make a single shot espresso.

D. Double Shot Button: Press to make double shots espresso.

E. Steam Button: Press to enter steam mode.

Before First Use

Cleaning The Appliance

- * Carefully remove the appliance from the packaging and remove all packaging materials.
- * Remove all accessories from the packaging and from the appliance.
- * Remove the water tank.
- * Clean the water tank with the lid, the measuring spoon and the filter as well as the filter holder with warm water and some mild dish-washing liquid. After that, rinse with clear water and dry.
- * Also, wipe the casing of the espresso machine and the drip tray with the drip grid clean with a soft, damp cloth and dry all parts.
- * Make sure that the steam knob is turned off (OFF position, turn all the way in a clockwise direction).

NOTE: The parts of the espresso machine and the accessories are not dish-washer safe.

Initial Use

- 01.** Fill the water tank with cold water up to the MAX level of the tank.
- 02.** Insert the plug into a wall outlet with suitable voltage(120V~, 60Hz).
- 03.** Press the Power button, the Power indicator light turns on and the coffee machine starts to preheat automatically. Once the preheating is finished, all the buttons will light up continuously. This preheating process takes about 2 minutes.
- 04.** Place a cup under the Steam Wand. Turn on the steam knob. Let the hot water flow out of the steam wand for about 8 seconds, then turn off the steam knob. This process is let the water flow into the empty pump for the first use.

NOTE: There will be a loud noise and little shake when the machine running first time. It's normal for a 20 bar pump. The noise will be weak in the future using.

- 05.** Insert the Filter into the Filter holder. (see image.1)

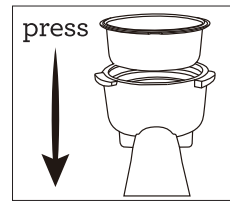

image.1

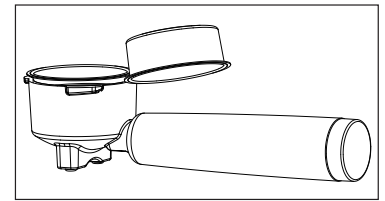

image.1.1

NOTE:

The filter might be a little tight and hard to take it out from filter holder when you want to change the filter. You can use another filter to pry it out.(see image.1.1).

- 06.** Insert the filter holder without coffee grounds into the brew head with a 45° movement to the left and turn it to the right to lock it in place.

The filter holder must be perpendicular to the machine or slightly tilted towards the right. (see image.2)

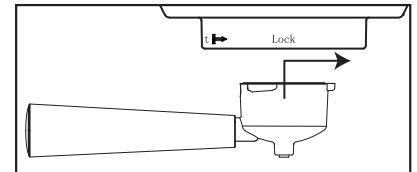

image.2

- 07.** Place a empty cup under the filter holder and press the single or double button to brew.

- 08.** After the brewing cycle has finished, pour the water out.

Now your coffee machine is ready to use.

Preparing the Espresso

A cold filter holder, filter and cup can reduce the extraction temperature enough to significantly affect the quality of your espresso. We recommend to run a brewing cycle without coffee ground to preheat them before extraction.

- 01.** Remove the filter holder and fill the filter with coffee grounds using the tamp spoon provided with the machine.
 - * We recommend 7-9g for single shot and 13-15g for double shot. The amount will vary depending on your preferences and the coffee grounds you used.
- 02.** Tamp the coffee grounds with the tamp spoon. The coffee grounds must be pressed evenly to obtain a well levelled and flat surface.
 - * Remove any coffee residue from the edge of the Filter Holder.
- 03.** Insert the filter holder into the brew head with a 45° movement to the left and turn it to the right to lock it in place. The filter holder must be perpendicular to the machine or slightly tilted towards the right.

Making the Espresso

- 01.** Make sure the steam knob is on “OFF” position.
- 02.** Place pre-warmed cup(s) beneath the filter holder.
- 03.** Press the single or double button for desired volume.

The flavor of your coffee will depend on many factors, such as the type of coffee beans, degree of roast, freshness, coarseness or fineness of the grind, dose of ground coffee, and tamping pressure. Experiment by adjusting these factors just one at a time to achieve the taste of your preference.

NOTE:

There will be noise during the operating process. This is normal for a 20 bar pump.

Frothing Milk

To prepare a traditional cappuccino or latte, we recommend:

- using cold, fresh whole milk. The density of the frothed milk will depend on the milk fat content.
- using stainless steel, circular, rounded milk jugs, narrower at the top, with a spout, necessary to make cappuccino decorations.

Before starting, it is important to slightly move the steam wand outwards in order to insert the jug directly under it and facilitate the movements required to froth the milk correctly.

Continue as follows:

01. Press the steam button. The steam button will start to flash if the temperature is not high enough to make steam. Once the preheating has finished, the Steam Button will light up.

02. Turn the steam knob slightly counterclockwise to eliminate any condensation from the wand then turn the knob off again. (see image.3.1-3.2)



image.3.1



image.3.2

03. Place the jug, half-filled with cold milk, under the steam wand.

04. Place the steam nozzle just below the surface of the milk. If it is inserted too deep, the milk will not be frothed; if it is not inserted deep enough, big bubbles will be produced and then disappear immediately. It is important to keep the Steam Tube not at the centre but close to the edge of the jug, with an appropriate angle to produce a stronger vortex. (see image.4.1-4.2)

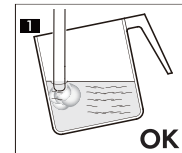

image.4.1

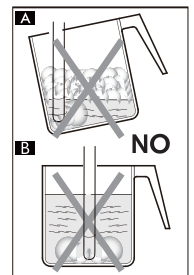

image.4.2

It is important to keep the Steam Tube not at the centre but close to the edge of the jug, with an appropriate angle to produce a stronger vortex.

05. Turn the steam knob to ☁/🔥 position. The steam will come out of the steam wand.

NOTE:

The entire operation should last no longer than 3 minutes, because the machine will stop making steam automatically after 3 minutes of continuous steaming.

NOTE:

To froth the milk correctly, the steam nozzle must always be in contact with the milk and not with the froth. Therefore, as the layer of froth increases, the jug must be slightly raised trying to keep the Steam Tube in contact with the milk, without touching the bottom of the jug.

06. Once the desired frothing has been achieved, the steam nozzle must be pushed deeper to heat the milk well.

NOTE:

It is advisable to always keep a hand on the rounded part of the jug to feel the temperature increase of the unfrothed milk.

07. Once the desired result has been achieved, turn the steam knob to “OFF” position to stop dispensing steam and remove the jug.

NOTE:

To make the froth more compact, it is advisable to lightly tap the jug on a flat surface after frothing.

08. Press the steam button again to quit the steam mode. Pour the frothed milk into the coffee.

▲ WARNING

The steam wand may be very hot during and after use. To avoid burns, move it only by placing your fingers on the rubber tip fitted on the steam wand.

09. Turn the steam knob on to eliminate any residue milk from the wand then turn the knob off again.

10. Do not make coffee immediately after frothing milk. The temperature of boiler is too high, and the machine is under the over-heating protection. Under the protection, the single and double button will flash if you press either of them.

The boiler must be cooling down first, or the coffee will be burnt and may come out of the filter holder. Please proceed as below 4 steps to cool up the machine.

- a.** Under the over-pressure protection, turn the steam knob to  position to make hot water.
- b.** Let hot water come out from the steam wand to cool down the boiler.
- c.** Once the temperature of boiler is cool down, all the buttons will fully illuminated.
- d.** Return knob to the “OFF” position, and the coffee machine is ready for the next brew.

Making Hot Water

01. Turn the machine on and wait until all the buttons light up.
02. Place a cup under the steam wand.
03. Turn the steam knob to ☁️/💧 position. The hot water will come out of the steam wand.
04. Once the desired amount of hot water has been dispensed, turn the steam knob off.

NOTE:

The entire operation should last no longer than 40 seconds, because the machine will stop making hot water automatically after 40 seconds of continuous working. If you want more hot water, run the cycle again.

NOTE:

The steam wand may be very hot during and after use. To avoid burns, move it only by placing your fingers on the rubber tip fitted on the steam wand.

Espresso Pressure Gauge

The gauge needle indicates the extraction pressure.

Ideal Espresso Zone

When it is positioned anywhere in espresso range during extraction, it means the espresso has been extracted at the ideal pressure. (see image.5)

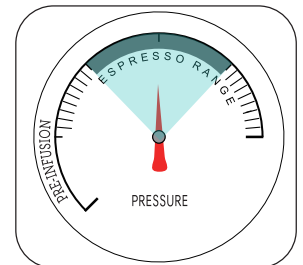

image.5

Low pressure zone

When the gauge needle is under the espresso range zone during extraction, this indicates the espresso has been extracted with insufficient pressure. (see image.6)

This can happen when the water flow through the ground coffee is too fast, resulting in an under extracted espresso that is watery, clod and lacks crema and flavor.

Possible causes for under extraction include: the grind being too coarse, insufficient coffee in the filter, insufficient tamping, or a combination of any of these.

To resolve this:

- 01. Select a finer grind setting and retry.**
- 02. Increase the amount of coffee grounds and retry.**
- 03. Increase the tamping pressure and retry.**

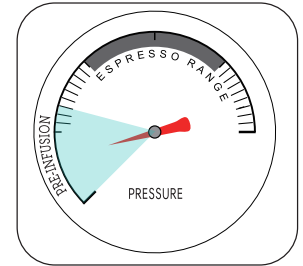

image.6

High pressure zone

When the gauge needle is above the espresso range zone during extraction, this indicates the espresso has been extracted with too much pressure. (see image.7)

This can happen when the water flow through the ground coffee is too slow and results in an over extracted espresso that is very dark and bitter with a mottled and uneven crema.

Possible causes for over extraction include: the grind being too fine, too much ground coffee in the filter, over tamping or a combination of any of these.

To resolve this:

- 01. Select a coarser grind setting and retry.**
- 02. Decrease the amount of coffee grounds and retry.**
- 03. Decrease the tamping pressure and retry.**

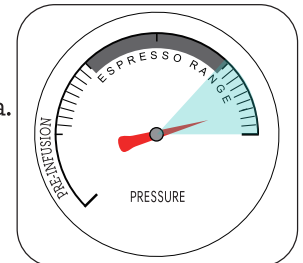

image.7

		GRIND	Amount of Coffee Ground	TAMP	SHOT TIME
OVER EXTRACTED	CAUSE	TOO FINE	TOO MUCH	TOO HEAVY	OVER 50 SEC
	SOLUTION	Grind coarser	Decrease the amount	Decrease the strength	
IDEAL EXTRACTION		OPTIMUM	7-9g (Single shot) 13-15g (Double shot)	20-33lbs (9-15kg)	25-45 SEC
UNDER EXTRACTED	CAUSE	TOO COARSE	TOO LITTLE	TOO LIGHT	UNDER 20 SEC
	SOLUTION	Grind finer	Increase the amount	Increase the strength	

Setting the Volume of Single and Double shot

Set the volume of single shot:

01. Keep pressing the single button for 3 seconds, the machine will beep 3 times quickly and start to brewing.
02. Press single button again once desired volume of espresso has been extracted. The machine will beep 3 times slowly to indicate the new volume of single shot has been set.

Set the volume of double shot:

01. Keep pressing the double button for 3 seconds, the machine will beep 3 times quickly and start to brewing.
02. Press double button again once desired volume of espresso has been extracted. The machine will beep 3 times slowly to indicate the new volume of double shot has been set.

NOTE: The brewing time is set between 8-60 seconds. Otherwise, the setting is failed to work.

Resetting Default Volumes

To reset the machine to the default single and double shot volumes, keep pressing the single and double buttons for 5 seconds. The machine will beep 3 times, and all the buttons will flash 5 times. The machine will return to its original default settings. (see image.8)

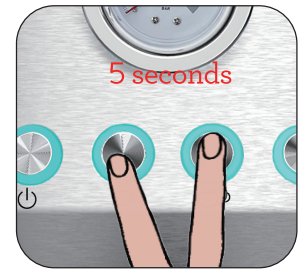

image.8

Cleaning and Maintenance

Regular cleaning and maintenance keep the machine in working condition and ensure perfect coffee flavour, a constant coffee flow, and excellent milk froth for a long period of time.

Cleaning the Filter Holder and the filters

The filter holder and filters should be kept clean to guarantee perfect results.

▲ WARNING To avoid burns, the filter must only be removed when the filter holder has cooled down completely.

- 01.** Remove the filter from the filter holder and wash them with warm water.
- 02.** If you notice a malfunction when brewing coffee, immerse the filter in boiling water for 10 minutes and then rinse with running water.

NOTE: Do not clean any of the parts in the dishwasher.

Cleaning the Steam Wand

- 01.** Immediately after frothing milk, turn steam knob on to purge out any residual milk from the steam wand.
- 02.** Clean the steam wand with a damp cloth. To clean it more thoroughly, you can unscrew the steam nozzle and wash it with running water.
- 03.** If the hole of the steam nozzle become blocked, ensure the steam knob is in the STANDBY position. Press the power button to turn the machine off and allow to cool. Use a pin to unblock the hole. (see image.9)



image.9

Cleaning the Brew Head

Regularly remove any residual coffee grounds from the brew head using a brush, and wash with hot water following the steps below.

- 01.** Insert the filter holder into the brew head without using coffee grounds.
- 02.** Place an empty cup under the brew head.
- 03.** Press the double button and fill the cup with water.
- 04.** Remove the filter holder from the brew head and clean the brew head with a dry cloth.

⚠ WARNING Do not try to disassemble the brew head. It will damage the Brew Head and lead to leakage.

Descaling

To make sure your coffee maker operates efficiently, to clean the internal pipes, and to preserve the flavor of your coffee, the coffee machine needs to be descaled, cleaned and maintained periodically.

Also, after 500 times of brew cycle, a descaling warning will be shown. The power button will flash 5 times to indicate it is time to descale the machine. The descaling warning will appear at every time start-up if you do not run a descaling cycle.

Please proceed as below steps to descaling the machine.

- 01.** Fill the water with descaling agent(4 parts water to 1 part descaling agent) into the water tank up to the Max marking.

NOTE: Please also refer to the instructions on the descaling agent. Please use a household descaling agent, or you can use citric acid instead of a commercial descaling agent - in this case use 100 parts of water to three parts of citric acid.

- 02.** Place a cup/mug or other suitable receptacle on the drip tray and keeping press the double and steam button together for 5 seconds. The machine will start the descaling cycle, and the descaling cycle will run 7 minutes then stop automatically. (see image.10)



image.10

- 03.** Repeat the previous steps until the water with descaling agent is running out.
- 04.** Next, repeat the process two more times using only CLEAN TAP WATER without any descaling agent.

Trouble Shooting

Problem:	Possible cause	Solution
Machine doesn't work.	Machine is not switched on or power plug is not plugged in.	Make sure that the power plug is plugged in, that the ON/OFF button has been pressed and that both coffee buttons light up blue.
	Short circuit / power out let is without power.	Check the power supply.
	The machine is faulty.	Contact our customer support.
Coffee does not or only slowly run out of the filter holder.	Water tank is empty.	Fill water tank.
	The water tank is not installed correctly.	Remove the water tank and correctly install it.
	The machine cannot pump the water.	Use hot water function to pump the water.
	Coffee is ground too finely.	Ensure appropriate degree of grinding.
	Too much coffee in filter.	Ensure appropriate amount.
	Ground coffee is tamped too strongly.	Tamp ground coffee less strongly.
	Filter is clogged up.	Clean the filters hole with a pin.
	The steam button is turn on (after using the hot water function and without turn off).	Turn the steam button off.
The machine is faulty.	Contact our customer support.	
Coffee runs through too quickly	Coffee is ground too coarsely.	Ensure appropriate degree of grinding.
	Too little coffee in filter.	Ensure appropriate amount.
	Ground coffee is not tamped strong enough.	Tamp ground coffee more strongly.
Coffee is cold.	Machine is not pre-warmed.	Let hot water run through the appliance with the inserted portafilter (with filter but without coffee grounds) before extracting the first coffee to warm up the brew system.
	Cups not pre-warmed.	Pre-warm cups with warm water.
Water is pooled under the coffee machine.	The water tank is not installed correctly.	Remove the water tank and correctly install it.

Water is pooled under the coffee machine.	The drip tray is filled with water.	Empty and clean drip tray.
	The machine is faulty.	Contact our customer support.
The steam fails to steam the milk.	The milk jug is too big or the jug shape is unsuitable.	Always use a tall, slim container ideally made from stainless steel.
	You have used milk with less than 3.3% of milk protein.	Use milk with more than 3.3% of milk protein.
	The milk is not cold.	Always use cold milk(41°F).
Not producing steam.	Water tank is empty.	Fill the water tank.
	Steam nozzle is clogged.	Remove the steam nozzle from steam wand and clean the steam nozzle with a pin.
	Steam function was used for more than 3 minutes.	Turn steam knob off for at least 1 minute.
	The machine is faulty.	Contact our customer support.
Hot water function is not working.	Water tank is empty.	Fill the water tank.
	Steam nozzle is clogged.	Remove the steam nozzle from steam wand and clean the steam nozzle with a pin.
	Hot water function was used for more than 40 seconds.	Turn steam knob off for at least 1 minute.
	The machine is faulty.	Contact our customer support.
Coffee is dripping out of the rim of the filter holder.	Too much coffee in the filter.	Make sure to use the correct amount of coffee.
	Coffee ground is sticking to the sealing ring of the brewing head.	Turn off the machine, wait until it has cooled down and then clean the filter, the filter holder and the brew head with its sealing ring
	Filter holder is not completely closed.	Insert the filter holder and turn the handle to the right until you feel some resistance.
	Maker espresso after frothing milk or using the steam function immediately.	Use hot water function to cool down the boiler first.
	The machine is faulty.	Contact our customer support.

NOTE:

If your problem is not listed, please contact Customer Support.

Warranty Information

The manufacturer provides warranty in accordance with the legislation of the customer's own country of residence, with a minimum of 12 months, starting from the date on which the appliance is sold to the end user.

The warranty only covers defects in material or workmanship.

The warranty will not apply in cases of:

- Normal wear and tear.
- Incorrect use, e.g. overloading of the appliance, use of non-approved accessories.
- Use of force, damage caused by external influences.
- Damage caused by non-observance of the user manual, e.g. connection to an unsuitable mains supply or non-compliance with the installation instructions.
- Partially or completely dismantled appliances.

Customer Support

If you have any questions or concerns about your new product, please contact our helpful Customer Support Team.

Contact our team by email:

Support@CASABREWS.com

Or scan the QR code for an additional barista book and more support.



* Please have your invoice and order ID ready before contacting Customer Support.



CASABREWS BRANDS INC.

1360 S Valley Vista Dr., Suite 108

Diamond Bar, California 91765

United States of America

support@casabrews.com

www.casabrews.com

CASABREWS