

LIGHTING AGENT

+44 (0) 161 791 7799

info@lightingagent.co.uk

Crystal House
Sadler Street
Middleton
Manchester
M24 5UJ
UK

CINDERELLA

LIGHTING

About Lighting Agent

We are a business-to-business manufacturer and wholesaler of luxury lighting with various wide-range designs of the highest quality. We aim to continuously inspire the interior design industry with our extensive collections.

With our manufacturing facility based in China and our head office in the UK, we are able to offer sales, supply, R&D and support to our customers worldwide. We also own and exclusively supply products under our brand Cinderella Lighting.

Lighting Agent's manufacturing department has numerous engineers who have gained decades of experience and skills in metal cutting and polishing, glass processing, specified crystal making, wood work and grinding, LED materials, shade manufacturing, PVC finishing, assembling, electricity installations, plating, painting, screws and many other relevant accessory manufacturing. Our team have strong ability and expertise to interpret and produce any lighting design, no matter grand or small, intricate or basic.

Lighting Agent is based in the heart of Europe and cooperates with outstanding global designers through intensive development as well as having partnerships with leading architects and interior design experts enabling us to participate in a number of significant projects around the world.

Premium Service & Worldwide Shipment

Lighting Agent's supply chain department follows every little detail to reach our customer's requests. Our professional QC team ensure only the best quality materials and warranted quality. The products are again checked for quality whilst being comprehensively prepared for transportation to the customer's satisfied hands. Our transport department ensures that all orders are systematically and swiftly processed. Whether your business is located in Asia, America, Europe or further overseas, Lighting Agent understand and embrace international differences and have the suitable logistic capabilities and partnerships to make sure operations run smoothly.

Lighting Project Operations

Lighting Agent's project team specialise in providing unique and sophisticated lighting designs and installations, mainly for hotels, restaurants, bars, lobbies, malls, buildings, palaces and for any individual requests. Our rich experience of project operations help to solve our customer's quality and technical issues efficiently.

FACTORY WITH UNLIMITED PRODUCTION CAPABILITIES

DESIGN - MANUFACTURE - INSPECTION - LOGISTICS - DELIVERY

From the design, development and manufacture of products to special accessories and installation, we provide a complete range of services in order to meet the needs of every customer.

We actively listen to our customers to deeply understand their needs and deliver the unique solutions that ensure their success.

We passionately pursue new technologies, capabilities and approaches, and work seamlessly across geographies to fully leverage our unmatched breadth and expertise in the design, manufacture and delivery of our products.

Scope of our services:

- Consultancy of lighting design
- Recommendations of lighting specification
- Professional technical advice and support
- CAD engineering and shop drawing preparations
- Product demonstration and sample supply
- High quality tailor-made lighting fittings manufacture
- Co-ordination with client's interior designers and contractors
- Production reporting
- Product certification testing
- Professional packing service
- Installation consulting
- Complete on-site testing & commissioning, assembly, installation and supervision
- Post-installation maintenance within our warranty period



electroplating

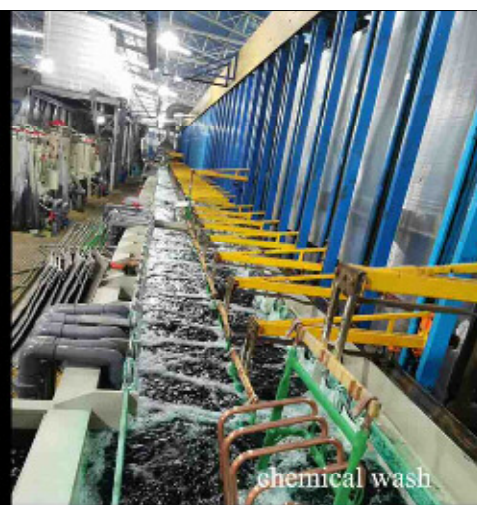

chemical wash

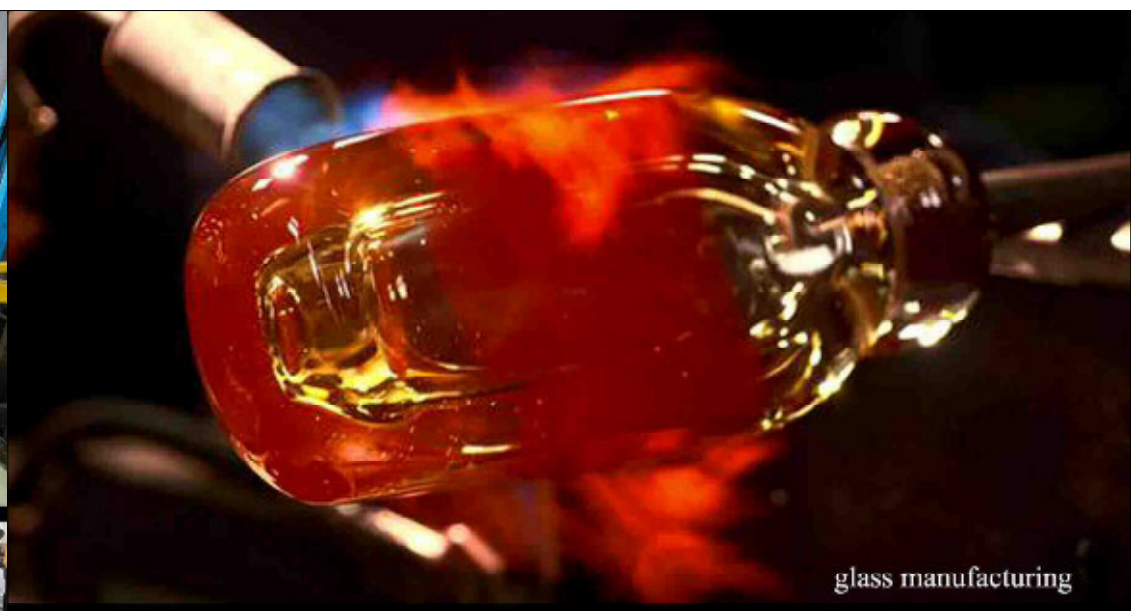

glass manufacturing



drying process



production line



glass manufacturing



glass manufacturing



acid bath

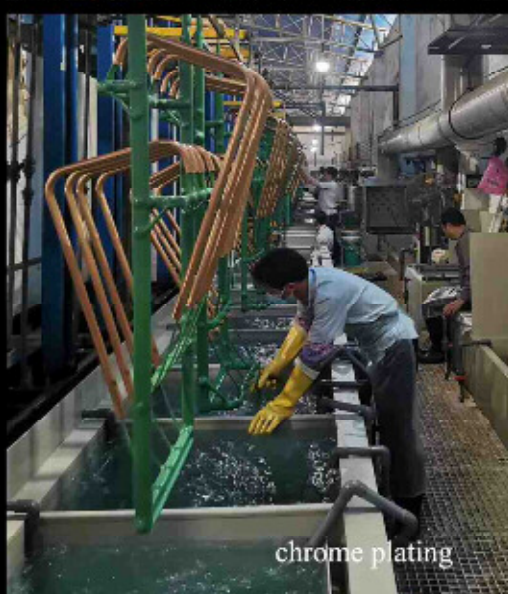

chrome plating



hand crystal frosting



hand made glass



robotic welding



metal pressing



project lighting inspection



wood cutting



large metal polishing



hand welding



product packing



general workshop



project lighting manufacturing



assembly workshop



metal work plant



metal cutting



detailed inspection



detailed inspection



sample department



glass chroming



glass shade testing



finished product



crystal polishing



hand made shade



shade inspection



warehouse



before inspection



hand made shades



shade packing



loading container



shipment preparation

UK STOCKED ITEMS



PL1809



PL1809S



PL1810



PL1810S



PL1747



PL1812



PL1811



PL1709



PL1709-1



PL1838



PL1836



PL1836S



PL1815



PL1706



PL1829



PL1822



PL1828



PL1831



PL1801



PL1711



PL1802



PL1816



PL1817



PL1707



PL1821



PL1818



PL1808



PL1804



PL1805



PL1819



PL1807



PL1844



PL1820



PL1860



PL1830



PL1853L



PL1853M



PL1881



PL1835



PL1701



PL1852



PL1857

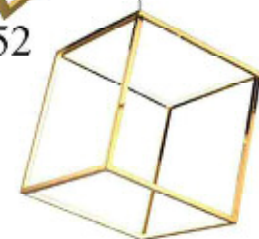

PL1852S



PL1858



PL1701S



PL1704

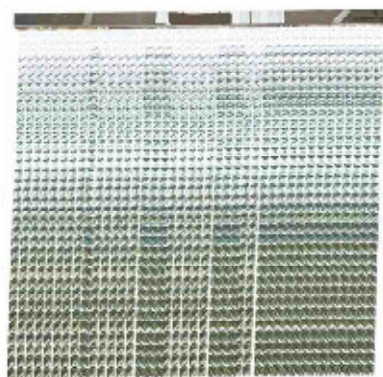

PL1880



PL1803

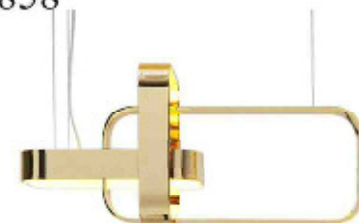

PL1877



PL1867



PL1718



PL1891



PL1839

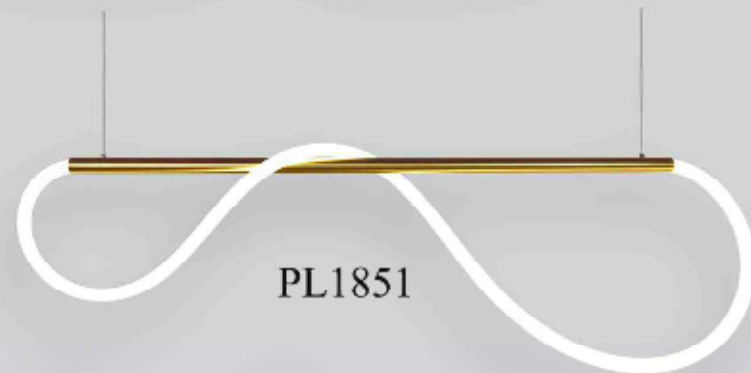

PL1851



PL1841



PL1875



TL1702



TL1820



TL1827



TL1750



TL1750S



TL1805

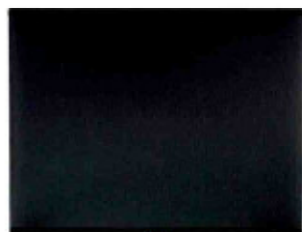

TL1708



TL1806



TL1824



TL1746



TL1746S



TL1828



TL1801



TL1822



TL1827



TL1826



TL1817



TL1825



TL1832



TL1851

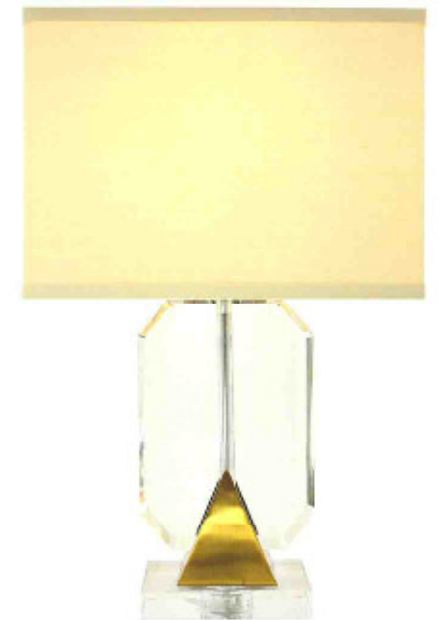

TL1844



FL1707



FL1782



FL1710



FL1711



FL1872



FL1873



FL1802

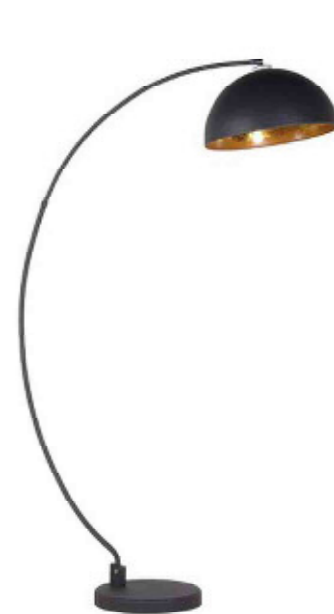

FL1726



FL1871



TL1749



TL1707



FL1708



TL1821



TL1839white



TL1839black



PL1876



PL1882





TL1703



FL1702



FL1801



TL1706



PL1705



TL1704



FL1703



FL1704



TL1705



PL1708



TL1710S



TL1710

FL1806



FL1804



TL1819



B1701-4W



B1704-6W



B1702-6W

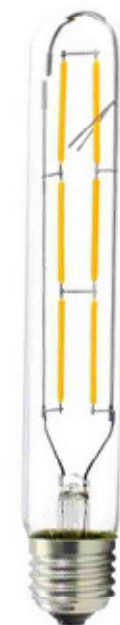

B1703-8W



B1901-16W



B1903-16W



B1902-16W



B1704-4W



IC1801Orange



IC1801Red

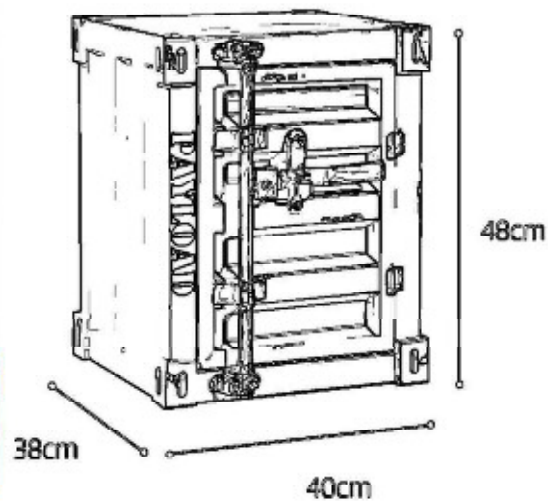

IC1801Black



IC1801Blue



IC1801Gray



OAMT-1701



IPL189



IPL191



IPL190



IPL195



IPL193



OAMT-1702



IC1901



WD



IPL192



IPL196



IPL197



IPL194

REFERENCE ITEMS FOR INSPIRATION



IPL153



IPL151



IPL152



IPL045



IPL024



IPL044



IPL156



IPL010



IPL012



IPL011



IPL054



IPL108



IPL040



IPL001



IPL007



IPL032



IPL099



IPL098



IPL095



IPL113



IPL002



IPL105



IPL003



IPL004



IPL008



IPL016



IPL066



IPL035



IPL104



IPL065



IPL090



IPL092



IPL013



IPL064



IPL086



IPL014



IPL005



IPL015



IPL039



IPL075



IPL149



IPL172



IPL062



IPL074



IPL173



IPL028



IPL029



IPL037



IPL055



IPL058



IPL076



IPL067



IPL057



IPL017



IPL145



IPL123



IPL117



IPL124



IPL027



IPL106



IPL122



IPL119



IPL021



IPL100



IPL049



IPL148



IPL146



IPL137



IPL186



IPL127



IPL126



IPL133



IPL141



IPL131



IPL139



IPL140



IPL125



IPL093



IPL053



IPL112



IPL052



IPL136



IPL128



IPL130



IPL138



IPL132



IPL056



IPL088



IPL181



IPL101



IPL184S



IPL174



IPL184



IPL175



IPL187



IPL188



IPL142



IPL158



IPL157



IPL160



IPL182



IPL159



IPL009



IPL069



IPL079



IPL070



IPL144



IPL109



IPL143



IPL097



IPL020



IPL030



IPL036



IPL031



IPL068



IPL071



IPL183



IPL073



IPL161



IPL163



IPL162



IPL164



IPL166



IPL185



IPL167



IPL171



IPL169



IPL170



IPL168



IPL176



IPL177



IPL178



IPL179



IPL180



IPL046



IPL047



IPL147



IPL050



IPL063



IPL051



IPL085



IPL080



IPL107



IPL061



IPL094



IPL115



IPL120



IPL081



IPL114



IPL116



IPL118



IPL111



IPL110



IPL135



IPL150



IPL048



IPL018



IPL121



IPL033



IPL019



IPL041



IPL042



IPL102



ITL001



ITL020



ITL038



ITL003



ITL005



ITL009



ITL025



ITL046



ITL039



ITL006



ITL028



ITL030



ITL026



ITL045



ITL040



ITL027



ITL029



ITL032



ITL033



ITL031



ITL035



ITL037



ITL011



ITL012



ITL023



ITL034



ITL036



ITL041



ITL042



ITL043



ITL044



ITL007



ITL015



ITL019



ITL013



ITL016



ITL018



ITL021



ITL022



ITL002



IFL011



IFL002



IFL052



IFL026



IFL029



IFL028



IFL051



IFL044



IFL017



IFL054



IFL022



IFL050



IFL023



IFL021



IFL049



IFL008



IFL007



IFL040



IFL017



IFL031



IFL032



IFL057



IFL005



IFL025



IFL027



IFL015



IFL018



IFL020



IFL058



IFL038

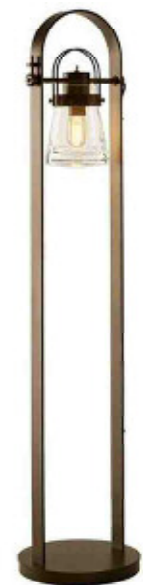

IFL043



IFL047



IFL056



IFL033



IFL034



IFL055



IFL030



IFL014



IFL037



IFL035



IFL036



IFL016



IFL041



IFL039



IFL042



IFL009



IFL010



IFL019



IFL053



IFL046



IFL048



IWL002



IWL003



IWL004



IWL006



IWL011



IWL005



IWL038



IWL014



IWL012



IWL046



IWL075



IWL060



IWL055



IWL057



IWL076



IWL072



IWL073



IWL061



IWL062



IWL063



IWL064



IWL083



IWL080



IWL081



IWL082



IWL069



IWL070



IWL066



IWL065



IWL067



IWL068



IWL078



IWL079



IWL077



IWL071



IWL085



IWL084



IWL089



IWL094



IWL090



IWL091



IWL092

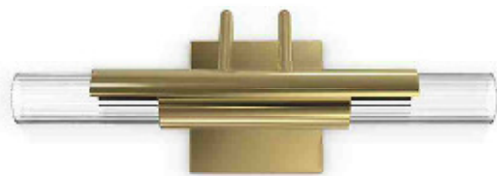

IWL093



IWL007



IWL017



IWL019



IWL029



IWL074



IWL028



IWL040

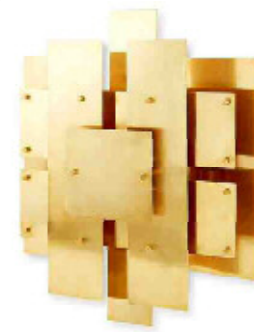

IWL099



IWL041



IWL025



IWL013



IWL018



IWL021



IWL023



IWL031



IWL033



IWL016



IWL036



IWL048



IWL030



IWL049



IWL008



IWL047



IWL051



IWL009



IWL098



IWL096



IWL097



IWL024



IWL026



IWL058



IWL054



IWL053



IWL042

WORLDWIDE PROJECTS EXCEEDING EXPECTATION

We design, develop, manufacture and install tailor-made fittings and lighting installations on a project basis to meet individual customer's requirements. Our attention to detail as reflected in the shop drawings is enhanced by our strong engineering capabilities.

Scope of our services:

- Lighting fixture design and consultation
- Full specification guidance
- Professional and technical advice
- Project design drawings
- Production samples provided
- Full project design and management under one roof, including liaison with designers and contractors
- Production progress reporting
- Product certification testing
- Secure and protective packaging
- Installation cooperation
- Problem prediction and debugging
- After sales service and warranty

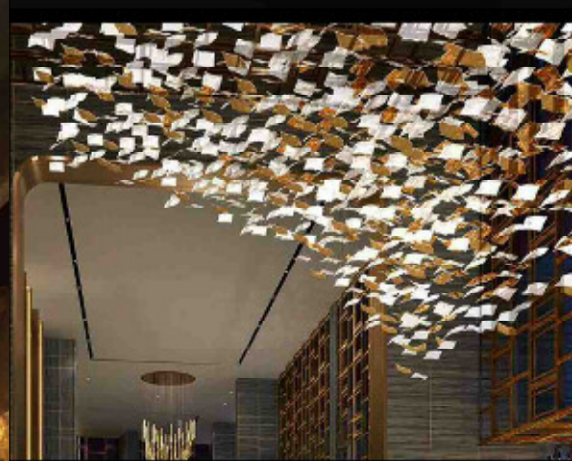
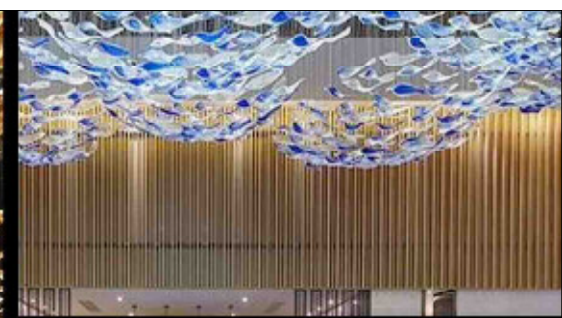

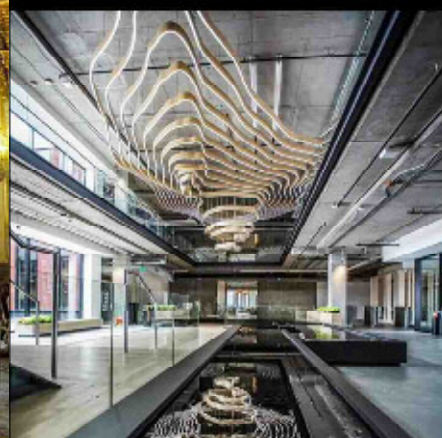
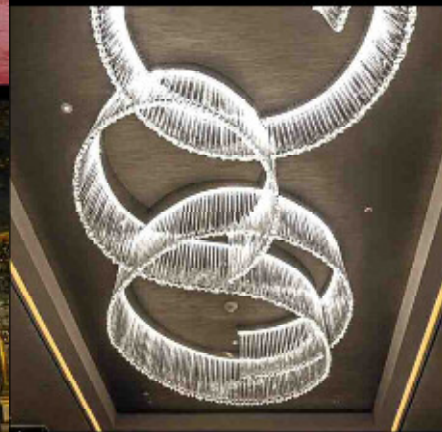

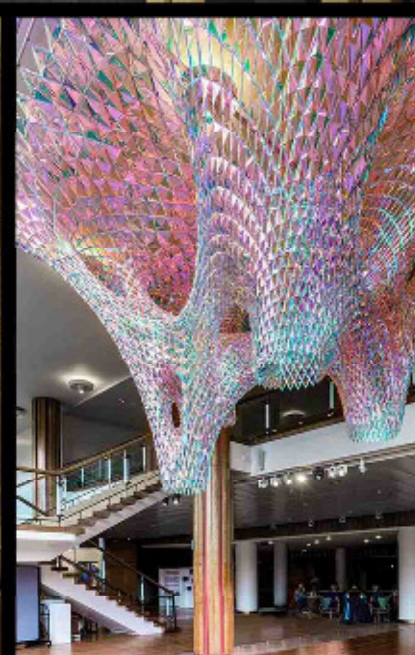
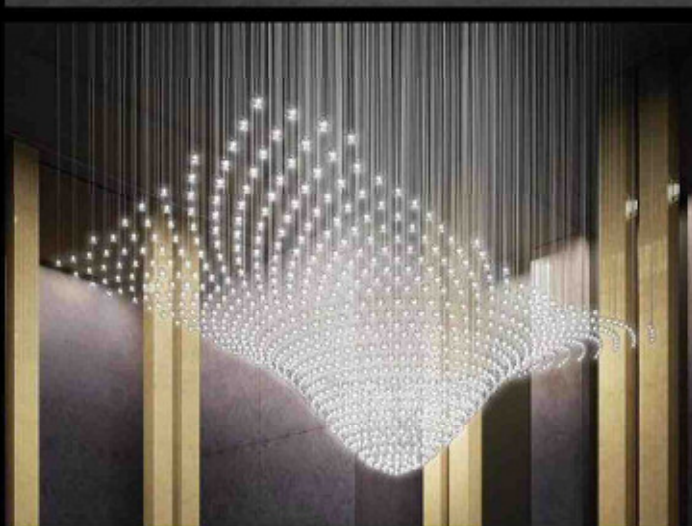
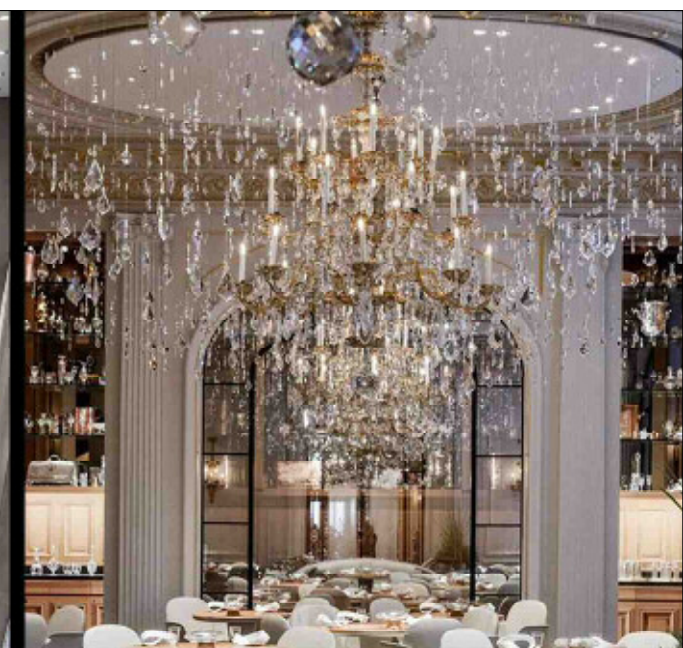
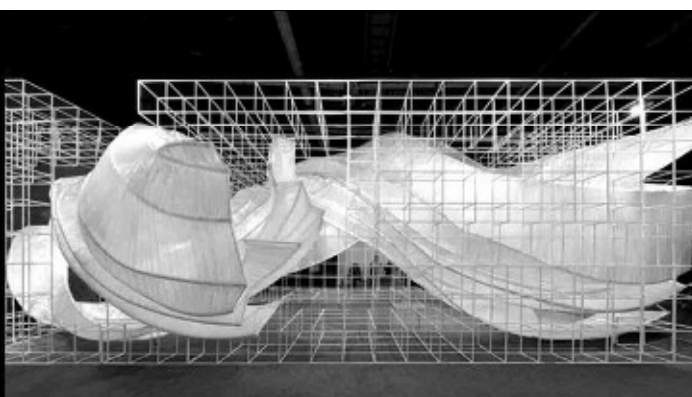



WL1814

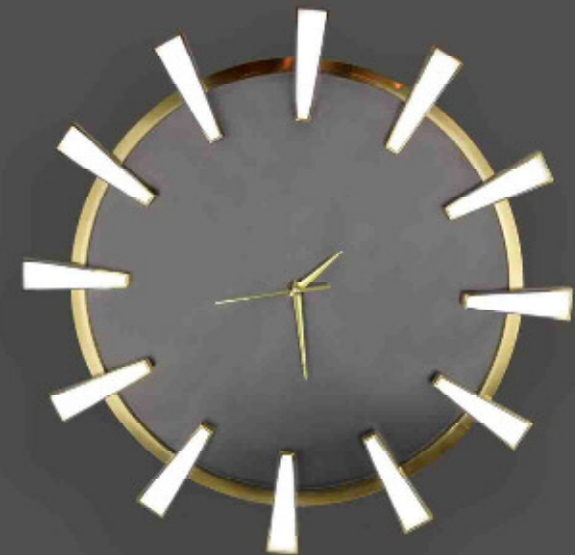

WL1736