



VITILAN EBIKE

Operation and maintenance manual

 www.vitilanebike.com



TABLE OF CONTENTS

Importance..... P1

Models and Pictures..... P2

Specifications P3

Safety and Compliance with the Law P4

Assembling Your New e-Bike..... P5-P9

Operating Your New e-Bike P10-P12

Intelligent Liquid Crystal Instrument..... P13-P30

Error Code Definition..... P31

Safety P32-P33

Trouble Shooting P34

PLEASE NOTE:

This manual is not intended as a detailed user, service, repair or maintenance manual. Please seek assistance from a qualified technician for service, repairs or maintenance.

IMPORTANCE

When using the electric bicycle, basic safety precautions should always be followed, including the following:

1. Read all instructions.
2. To protect against fire, electric shock and injury to persons, do not immerse cord, plugs, or e-bike in water or other liquid.
3. Close supervision is necessary when the e-bike is used by or near children.
4. Unplug from outlet when not in charging and before cleaning.
5. Do not operate the e-bike with a damaged cord or plug or after the e-bike malfunctions, or has been damaged in any manner. Take the e-bike to the nearest authorized service bike shop for examination, repair or adjustment.
6. The use of accessory attachments not recommended by the e-bike manufacturer may result in fire, electric shock or injury to persons.
7. Do waterproof when using on a rainy or snowy day.
8. Do not let cord hang over the edge of table or counter, or touch hot surfaces.
9. Do not place on or near a hot gas or electric burner, or a heated oven.
10. Always attach the plug to the battery first, then plug the cord into the wall outlet.
11. Do not use the bike for other than intended use.
12. Save these instructions.

***Note that this is a general manual. VITILAN reserves the right to make changes to products and designs. The e-bike you own may not be the same style as the pictures shown in this manual.**

MODEL: U7



Specifications

- MODEL: U7
- Frame Construction: Aluminum Alloy
- Gear Range: 7-speed type
- Tire Size: 20" (565mm)
- Climb Grade: 30 degree
- Max load: 150kg (330 lbs)
- Max Speed: 28mph(Actual speed depends on road conditions, weather, rider weight)
- Power: 750W
- Battery Capacity: 48V 16Ah
- Battery Charger: US Standard 54.6V 3.0A Charger, Voltage 110-240V
- Battery Operational Temperature: 0°to 40° Celsius (32°to 104°Fahrenheit)
- Battery Life: Approximately 600 complete charge/discharge cycles
- Folding risers: There is a toothed folding riser, right fold, 8 degrees forward
- Seat tube: 25.4*350MM aluminum alloy flip shock absorbing seatpost
- Sprocket: 3/32/48T*170mm, STEEL, sand black, square hole inch, with 9/16, aluminum alloy double chain cover

Read This First: Safety and Compliance with the Law

Congratulations on your purchasing of your new e-bike. Your new e-bike is an excellent piece of personal transportation equipment that will give you good service for many years.

Before you start using your e-bike, we want you to be aware of a few important points. Please read this section carefully.

- **Observe Laws Regarding the Use of Battery-Operated Bicycles**

Your e-bike is designed and manufactured to meet safety requirements as a battery-operated bicycle. However, state and local laws governing the use of battery-operated bicycles on public roadways, parks, and other open areas may differ. Please check with your local authority before using your e-bike in public areas.

- **Observe Laws Regarding the Use of Bicycles**

Note that all laws regarding the use of bicycles in public areas, such as those mandating the use of helmets and the use of infant seats, will automatically apply for e-bikes. Check with your local authority on what restrictions might apply.

- **The Lithium-ion Battery of Your e-Bike**

Your e-bike is equipped with the latest battery technology. The lithium-ion battery is much lighter than lead- or nickel-based batteries that are being used in some older models.

- **Your First Ride**

Please be VERY CAREFUL when you are ready to get on your e-bike for the first time because that the e-bike moves significantly faster than a regular bicycle at active power-assisted mode. Take your e-bike to an area with a lot of open space before you start. Do not start pedaling hard as soon as you get on the e-bike (as you normally would be with a regular bicycle), as the e-bike will accelerate under pedal-assist mode and you may be unprepared for the sudden increase in speed. However, after a few times, you will enjoy using the pedal-assisted function.

Assembling Your New e-Bike

If you purchased your e-bike unassembled, please follow these instructions to assemble your e-bike under the guidance of an adult or a qualified technician. Assembly is quite easy as most of the parts are already assembled; you need only to put a few pieces together to complete the job.

For more information. Please refer to the following way:

Email: support@vitilanebike.com

Facebook: Vitilanebike

Instagram: Vitilanebike

Website: www.vitilanebike.com

Youtube: Vitilanebike

Twitter: Vitilanebike

Remove the Battery

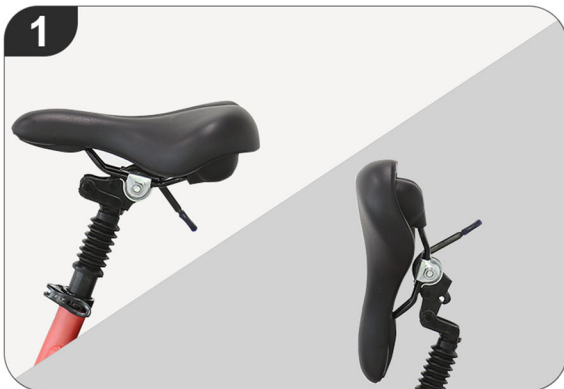

1. Open the buckle.

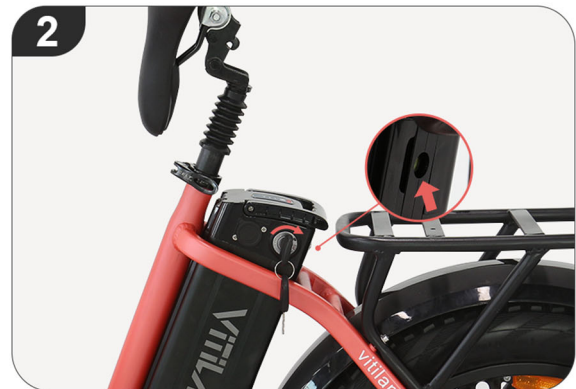

2. Push the key up once, then turn the key to retract the lock.

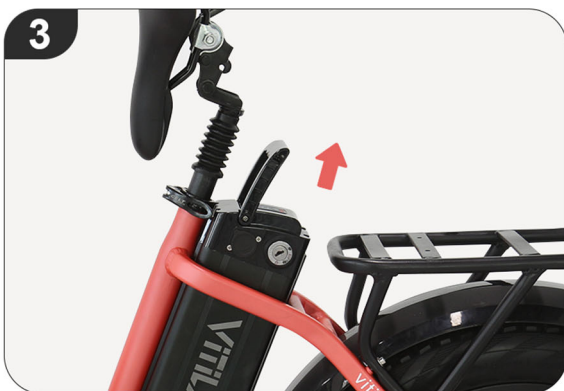

3. Fold the frame and remove the battery.



● Check that the Package is Complete and Undamaged

Your e-bike comes in a carton containing the following:

- ✧ The main body of the e-bike – consisting of the frame, the front and rear wheel, the gear and chain, the front and rear brake, the battery on the frame, the rear fender.

- ✧ The handlebar subassembly with the battery's keys that attached on it – the handlebar subassembly is not really separate, as it is connected to the main body by the brake cables and electrical wires. The handlebar also has the brake levers and gear control already assembled. Additionally, the handle also has an integrated control for the throttle mode power-assisted, a display panel.

- ✧ The Seat – the seat is attached to its pedestal stem.

- ✧ Tools and other parts –tools, one charger, a pair of foot pedals and this manual, they are contained in a separate box.

- ✧ Before the bike leaves the factory, the tire pressure is about half as low. Before riding, check for adequate air pressure.

- **Assembly - Step 1: Attach the handlebar subassembly**

Stand the main body of the e-bike on the kickstand. Stand up and lock the steering column that is at the front of the main body frame, insert the stem of the handlebar subassembly into it. Make sure that the fork (that will hold the front wheel) is pointing forward, and orient the handlebar accordingly. Insert the stem all the way and tighten from the top using the quick lock.

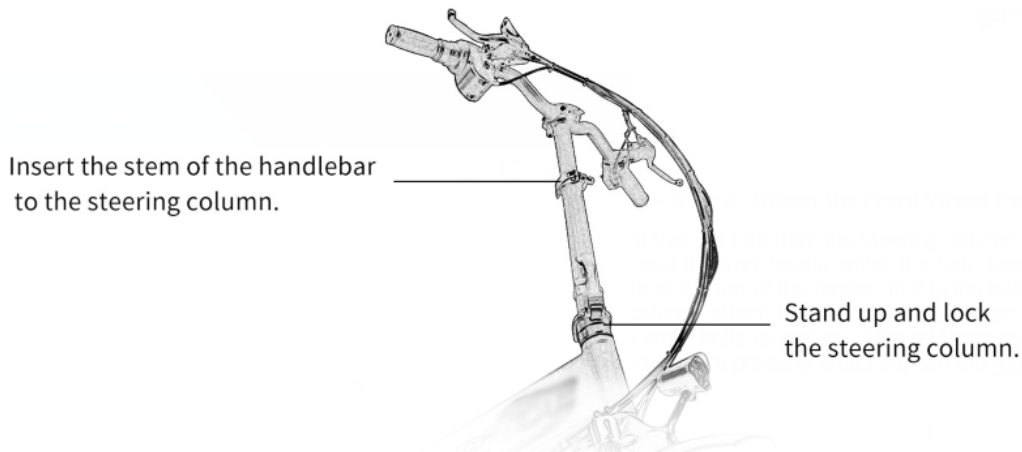

- **Assembly - Step 2: Installing the Seat and Pedals**

Insert the pedestal stem of the seat into the seat column of the main body frame, use the built-in lever to tighten.

Attach a pedal on each side of the crank, note the distinction between left pedal and right pedal, tighten with the multi-tools.

Note the distinction: the installation of the left and right pedals



Inflate the tires to proper pressure.

At this point, your e-bike is a completely functional bicycle, although without any battery operated to function as yet. Check all tightening points to make sure. Take a short ride. Adjust the height of the handlebar, and the height and the tilt of the seat, if necessary, for maximum comfort.

- **Assembly - Step 3: Charging the Battery**

Take out the charger from the box, attached the power cord and insert that to any wall outlet. Insert the plug at the end of the smaller cable into the charging terminal of the battery and start charging. The charging terminal is on the side of the battery opposite to a hole on the side of the frame. The LED on the charger glows RED while charging and glows GREEN when charging is complete. The battery should be turned OFF while being charged. When the LED on the charger turns Green, disconnect the charging cord and cover the charging terminal with the rubber cap. If a battery is installed on the e-bike and turned ON, the display panel will show the charge level of the battery when the bike turned ON.

You are now ready to start using your e-bike.

Operating Your New e-Bike

The method to turn on the bike is:

- I. Twist the battery lock counterclockwise to the end to turn on the battery;
- II. Press power button on the left handle bar until the display lights on;
- III. Ride on the bike and twist the throttle bar or pedal the bike, the bike will move, you can change the power level with control buttons, level 1 is the slowest and level 5 is the fastest, level 0 is human model.

Your e-bike is driven by a motor embedded in the hub of the rear wheel. The motor is powered by a battery. The amount of power delivered to the motor, and hence the accelerating force on the e-bike, is controlled by you in a way according to the power-assisted mode or full power mode you choose.

You can configure the e-bike to operate in the pedal-assist-only-mode or the full power mode (should check against local laws to ensure full power mode is permitted) where you can also use the hand throttle to deliver power to the motor.

● Your First Ride

(Reprinted from the Safety and Compliance with the Law section)

Please be VERY CAREFUL when you are ready to get on your e-bike for the first time because the e-bike moves significantly faster than a regular bicycle at active power-assisted mode. Take your e-bike to an area with a lot of open space before you start. Do not start pedaling hard as soon as you get on the e-bike (as you normally would do with a regular bicycle), as the e-bike will accelerate under pedal-assist mode and you may be unprepared for the sudden increase in speed. However, after a few times, you will enjoy using the pedal-assisted function.

● Pedal-Assisted

You must turn on the battery to use the e-bike in pedal-assisted mode.

In the pedal-assisted mode, power assist is triggered when you pedal forward, and power assist stops when you stop pedaling, sometime would be delay. In other words, power assist happens as long as you pedal. You don't need to pedal hard. All you need is to apply a light force to the pedals continuously to maintain the current flow. When you apply one of the brakes, power assist will automatically stop, allowing the e-bike to slow down and stop. Power assist will turn itself off when the e-bike has reached the maximum speed that the power level you choose.

You should use the gear shifter at the handlebar to set the gears appropriately according to road conditions and pedal, as usual, you will find that you need to exert a lot less effort and the e-bike travels faster and at a more steady speed.

- **Cruise Control**

Cruise Control will be triggered when you holding thumb throttle for 8 seconds, and it will be released by braking/pedaling or throttling.

- **Thumb throttle Control**

In the hand throttle mode, amount of power assist is determined by the throttle switch controlled by your hand. You control the throttle by twisting it from its resting position, the farther the throttle switch is from its resting position, the more power is delivered to the motor to accelerate the e-bike. When you want to slow down, you simply release the throttle and let it return to its resting position, and simultaneously apply the brakes if necessary.

You do not need to pedal the e-bike if you use the hand throttle. However, you can pedal while commanding power assist. If you do pedal to help the movement, you conserve energy and the charge in the battery will last longer.

- **Charging Your e-Bike Battery**

Your e-bike battery is a lithium-ion battery. Lithium-ion battery requires specially designed chargers. You should never charge your battery with a substitute charger that is not designed for this use. Use of an unsuitable charger to charge a lithium-ion battery will result in overheating, fire or even explosion. Ensure charger voltage is consistent with battery voltage. If your charger is lost or damaged, contact your dealer to order a replacement.

Charge your battery while the e-bike is not in use. You should turn off the battery before you charge it. You may charge your battery while it is mounted on the e-bike, or after it has been removed from the e-bike.

Do not place either the charger or the battery near flammable substances while charging is taking place. Charging should not be done in the vicinity of infants and small children. It is also prudent to remove valuable objects from the immediate vicinity of the battery while it is being charged. Don't charge in unattended condition for a long time. For the safety of you and your family, it is recommended not to charge in the middle of the night.

In order to maintain battery life, do not charge until the battery completely discharged, it is recommended to start charging when the power is less than 20 percent. If the battery will not be used for an extended period of time, charge it fully and recharge it every month. If not used for several months, the battery may be completely self-discharge and unable to charge.

The length of charging time depends on the level of charge the battery still holds. If a battery is completely discharged, it will take about 6 hours to be fully recharged. When a battery is fully charged, the LED on the charger will transition from RED to GREEN. At this point, you should disconnect the charger. Do not leave the charger

connected to the battery for a very long period of time after charging is complete.
(Leaving it connected for an overnight charging is OK.)

It is normal for the charger and the battery to be slightly hot while charging is on-going.

● **Removing the Battery from the e-Bike**

The battery is an important and costly part of the e-bike. It is designed to be locked into position with a key to preventing theft. You can take further precaution by removing the battery while the e-bike is parked unattended. You may also have a need to remove the battery from the e-bike to recharge it at a location where you cannot park your e-bike.

The method to remove the battery is:

- I. Open the cap of the charging port and fold the bike;
- II. Insert the key into the battery, hold pressing the key a bit until twist clockwise to the end (Note: You can't remove the battery until the lock bar withdraws into the battery completely);
- III. Slip off the battery, the battery is quite heavy and you should take care not to drop it.

● **Maximizing the Riding Range**

Many factors affect the rate of use of the electrical energy and the riding range.

- ✧ You should fully charge the battery before a long journey.
- ✧ Rough road conditions and hilly terrain will consume more energy.
- ✧ Frequent change of speed will consume more energy.
- ✧ Carrying more weight on the e-bike will consume more energy.
- ✧ Keeping the tires properly inflated and keeping the e-bike clean and well lubricated will save energy.
- ✧ Making sure that both wheels move freely when brakes are not applied will save energy. You should check brake adjustments frequently.
- ✧ Pedaling as you ride will consume less electrical energy and increase the riding range.
- ✧ When the battery is turned off, your e-bike functions as a regular bicycle. If you embark on a very long journey, you might want to turn off the battery for long stretches where the road is level or downhill and pedal the e-bike as a regular bicycle so that you can conserve electrical energy stored in the battery.

Care and Maintenance for Your New e-Bike

You should, in general, take care of your e-bike the way you would with a regular bicycle by keeping it dry, clean and the moving parts well lubricated. You should also avoid parking your e-bike in exposed areas whenever possible.

You should check the effectiveness of the brakes before each use.

● For your e-Bike, you should also take note of the following:

- ✧ Your e-bike is designed for regular country road use for a single person. Using your e-bike for extreme maneuvers, such as extreme off-road use, jumping, or carrying the excessive load will damage the e-bike and could cause serious injury.
- ✧ Do not use high-pressure water streams to clean your e-bike, as water might seep inside the motor or the wiring compartment and cause rusting of electrical parts or short circuits.
- ✧ Avoid parking your e-bike outside when there is rain or snow. At the end of a trip where there was rain or snow, bring the e-bike inside and use a clean, dry towel to eliminate any wetness.
- ✧ Be sure you do not lose both keys and remote controls. If you lost one key, you should immediately make a copy as a back-up. If you lost both keys, you will be unable to remove the battery from the e-bike. If you lost both remote controls, you can't turn on the bike.

● Special Care for the Battery and the Charger

- ✧ Use only the supplied charger to charge your battery. Do not use an unauthorized substitute. If your charger is lost or damaged, contact your dealer to order a replacement.
 - ✧ Do not open or alter the battery or the battery charger.
 - ✧ Do not place the battery near fire or corrosive substances. Do not immerse in water or other liquids.
 - ✧ Avoid subjecting the battery from high temperatures, such as directly under the hot sun, for prolonged periods of time.
 - ✧ Do not connect (short circuit) the two poles of the battery.
 - ✧ After much use, your battery's charge holding capacity will decrease. If you find that your battery does not hold sufficient charge even for short trips, you should contact your dealer to order a replacement. Under normal use, the battery will undergo 500 charging and discharging cycles.
 - ✧ If the battery will not be used for an extended period of time, charge it fully and recharge it every month. Store it in a cool place.
- ² Your e-bike battery is engineered with precision for high capacity and long useful life. We do not recommend that you use it to power other electrical devices. Improper use of the battery will damage the battery and shorten its useful life and may cause a fire or an explosion.

1. Product name and model

Electric bicycle intelligent LCD instrument; model: YL91F-V.

2. Specifications

- 36V/48V/52V power supply
- The rated working current of the instrument is 15mA
- The maximum working current of the instrument is 30mA
- Shutdown leakage current <1uA
- Supply the working current of the controller end 50mA
- Working temperature -20 ~ 60°C
- Storage temperature -30 ~ 70°C

3. Appearance and size



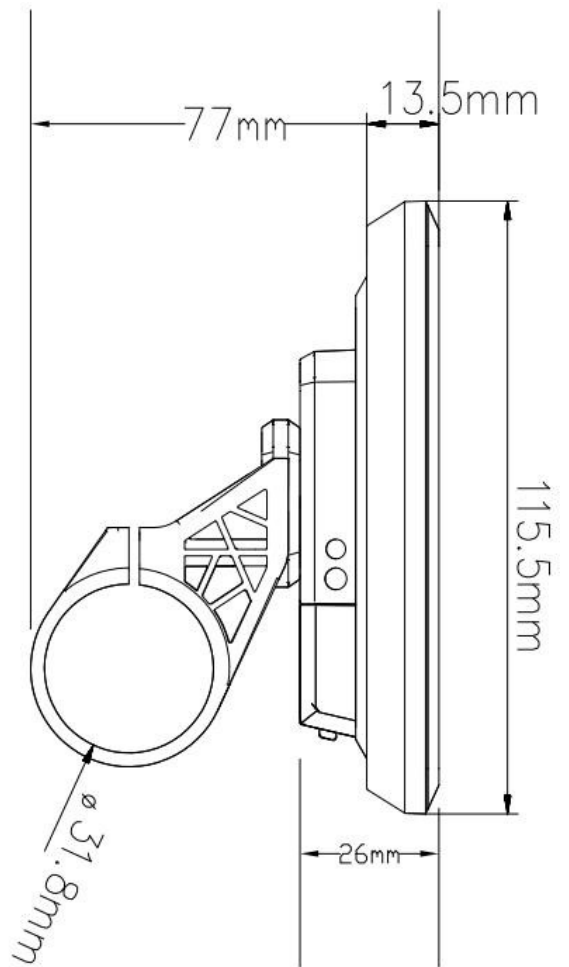
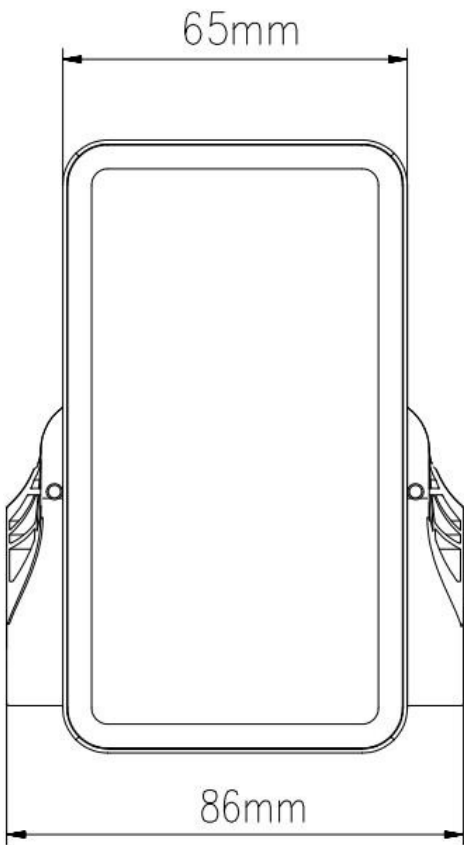

4. Function overview and Functional areas

4.1 Functional overview

- Battery level indicator
- Pedal assist (PAS) level indicator
- Speed (current speed, maximum speed, average speed)
- Mileage display (single and total mileage)
- Walk boost mode
- Light ON/OFF
- Error code indicator
- Personalized parameter settings (e.g. wheel diameter, speed limit, battery power setting and PAS parameter setting,



password setting, controller current limit setting, etc.).

- Factory default parameter recovery function

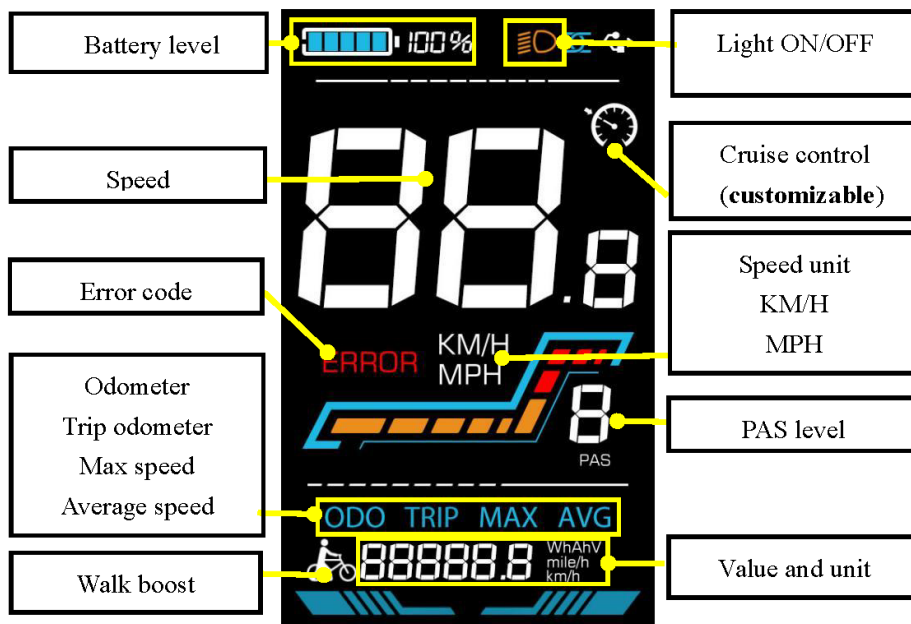
4.2 Functional areas



4.3 Button definitions

The display is equipped with five buttons on the corresponding operating unit: power on/off  , plus  ,

minus  , light  and toggle .

5. Routine operation

5.1 Power on/off

Long press  to power on/off the display. When the display is off, it will not use the battery power and the leakage current is less than 1uA.

⚠ The display will automatically shut off if it is not used for more than 10 minutes.

5.2 Display interface switching

When the display is powered on, it will show the Current Speed (km/h) and Odometer (km) by default. Short press

i to switch between Odometer (km), Trip Odometer(km), Maximum Speed (km/h), and Average Speed (km/h).

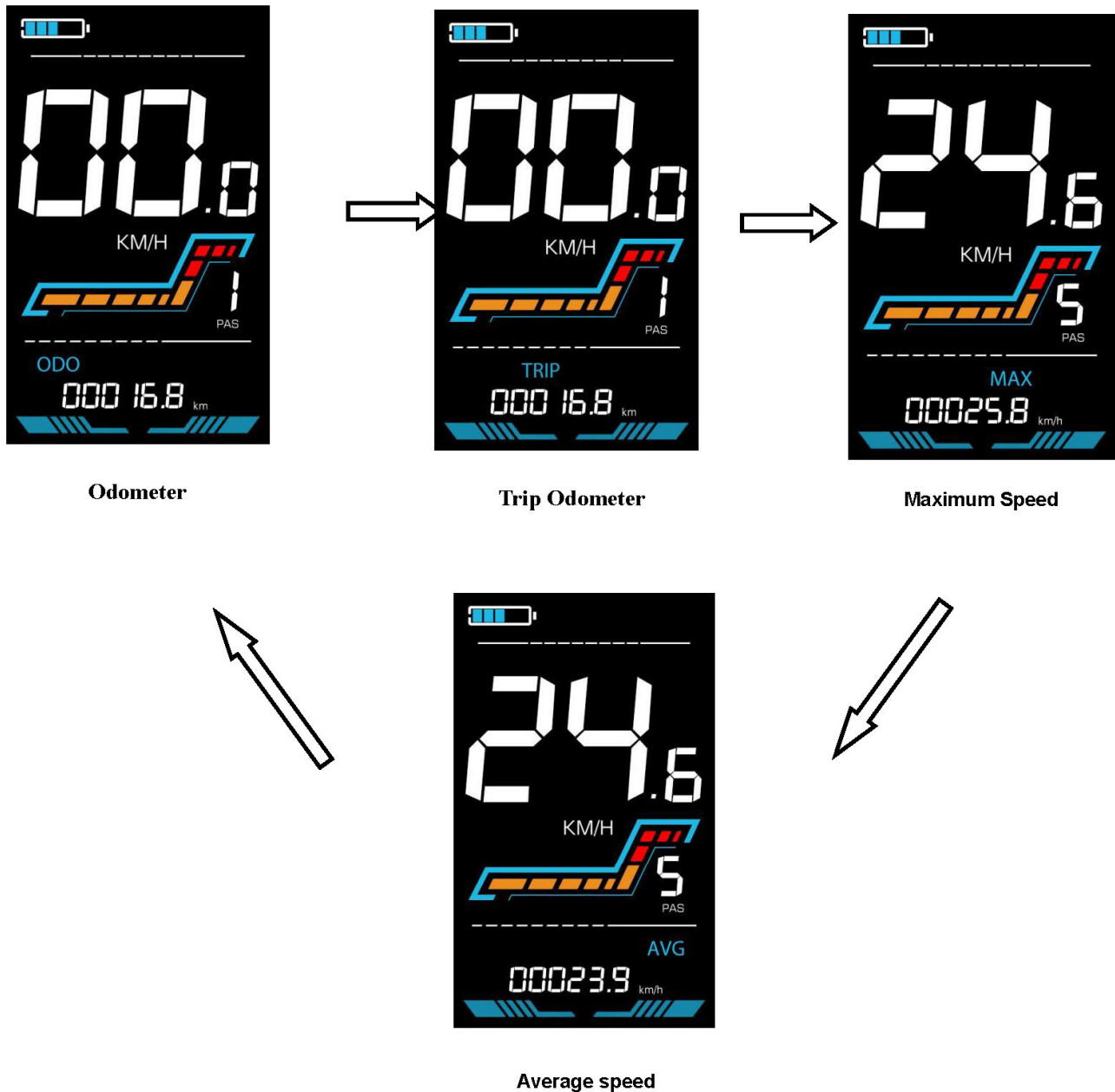

Figure 5-1 Display Interface Switching

5.3 Walk boost mode



Long Press and hold , the electric bicycle enters the walk boost mode. The electric bicycle will walk at a fixed speed of 6 km per hour and the display shows . Release the button to stop the power output immediately and restore to the state before walk boost.



Figure 5-2 Helping to implement the display screen

⚠ The walk boost mode can only be used when pushing the electric bicycle, please do not use it while riding.

5.4 Turning on/off lights





Press the  to make the controller turn on the lights and the display backlight becomes dim. Press  again to make the controller turn off the lights and the backlight restore brightness.



Figure 5-3 Backlight display interface

5.5 PAS level selection

Press  /  to switch PAS level of electric bicycle, thus changing the motor output power.

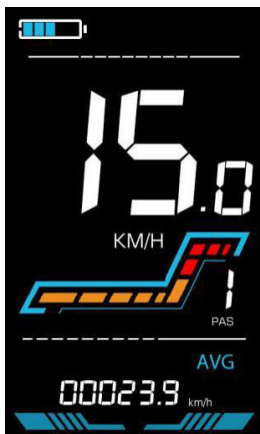

Figure 5-4 PAS level display interface

5.6 Battery level display

The Battery level is shown as 5 bars. When the battery is full charged, all of the 5 bars lighten up. When the battery is fully depleted, the bar will begin to flash, warning the user to charge the battery as soon as possible.

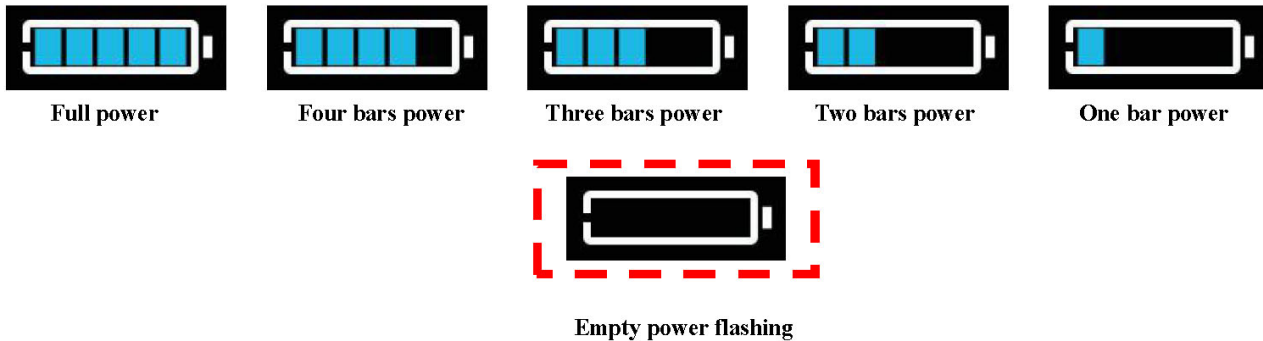

Figure 5-5 Battery Level Display Interface

5.7 Error code display

If there is a fault occurs in the electronic system of the electric bicycle, the display will automatically show an error code, see **Schedule 1** for a detailed definition of the error code.

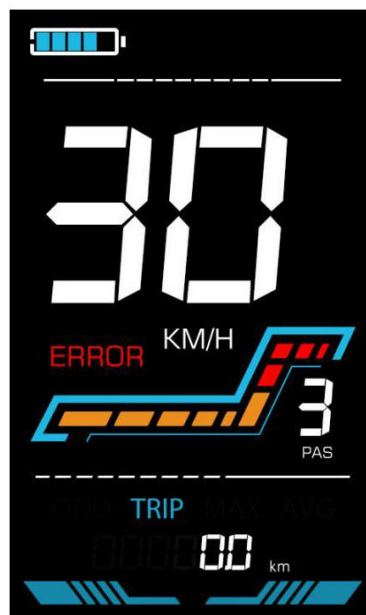

Figure 5-6 Error Code Display

⚠ When the error code appears on the display, please troubleshoot the problem in time, the electric bicycle will not be able to drive normally after the problem occurs.

6. Personalized parameter settings

⚠ Each setting needs to be done with the bicycle stationary.

The personalized parameter setting procedure is as follows:

When the display is ON and the speed shows 0,

(1) Press and hold **+** **-** simultaneously for more than 2 seconds to enter the personalized parameter setting interface.

(2) Press **+** / **-** to toggle between the personalized parameter setting interface, and press **i** to enter the parameter changing state.

(3) Press **+** / **-** to select the parameter, long pres **+** for addition operation, long press **-** for subtraction operation.

(4) Press **i** to save the parameter settings and return to the personalized parameter setting interface.

(5) Long Press **i** to save the parameter settings and exit the personalized parameter setting interface.

The following options are available on the personalized parameter setting interface:

6.1 Metric and Imperial setting

P1 is the metric and imperial setting, 00 for metric and 01 for imperial.

Press **i** to enter the parameter changing state. Press the **+** / **-** to select the parameter and press **i** to save the parameter setting and return to the personalized parameter setting interface.



Figure 6-1 Metric and Imperial Units Setting Interface

6.2 Rated voltage setting

P2 is the rated voltage setting. The available rated voltage range is: 24V, 36V, 48V, 52V.

Press **i** to enter the parameter changing state. Press the **+** / **-** to select the parameter and press **i** to save the parameter setting and return to the personalized parameter setting interface.



Figure 6-2 Rated voltage setting interface

6.3 PAS level setting

P3 is the Pedal assist (PAS) level setting. The available Pedal assist level settings are: 0~3, 1~3, 0~5, 1~5, 1~7, 0~7, 0~9, 1~9.

Press **i** to enter the parameter changing state. Press the **+** / **-** to select the parameter and press **i** to save the parameter setting and return to the personalized parameter setting interface.



Figure 6-3 PAS level setting interface

6.3.1 PAS level ratio value setting

To meet different requirements for users, the speed of every level can be adjusted by setting the PAS level ratio value. Please see the details from Schedule 2.

For example, “45-55%” is the ratio range of PAS 1, which is adjustable.

Press the **+** / **-** to select the parameter and press **i** to save the parameter and enter into the next level setting.

Press **i** again to save the settings and return to the personalized parameter setting interface.



Figure 6-4 PAS level ratio value setting interface

6.4 Wheel diameter setting

P4 is the wheel diameter setting. The adjustable wheel diameter range is: 8~50inch.

Press **i** to enter the parameter changing state. Press the **+** / **-** to select the parameter and press **i** to save the parameter setting and return to the personalized parameter setting interface.



Figure 6-5 Wheel diameter setting interface

6.5 Number of speed sensor magnets setting

P5 is the speed sensor magnet number setting. The adjustable speed sensor magnet number range is: 1 ~ 15 pcs (5S protocol) ,1 ~ 63 pcs (KDS protocol)

Press **i** to enter the parameter changing state. Press the **+** / **-** to select the parameter and press **i** to save the parameter setting and return to the personalized parameter setting interface.



Figure 6-6 Number of speed sensor magnets setting interface

6.6 Speed Limit Setting

P6 is the speed limit setting.

Press **i** to enter the parameter changing state. Press the **+** / **-** to select the parameter and press **i** to save the parameter setting and return to the personalized parameter setting interface.



Figure 6-7 Speed limit setting interface

6.7 Controller current Limit Setting

P7 is the controller current limit setting. The adjustable range is: 1~31.5A.

Press **i** to enter the parameter changing state. Press the **+** / **-** to select the parameter and press **i** to save the parameter setting and return to the personalized parameter setting interface.



Figure 6-8 Controller current limit setting interface

6.8 PAS sensor setting

P8 is the PAS sensor setting.

6.8.1 PAS sensor direction setting

run is the PAS sensor direction setting. run-F is front direction and run-b is opposite direction.

Press **i** to enter the parameter changing state. Press the **+** / **-** to select the parameter and press **i** to save the parameter setting and enter into 6.8.2 PAS sensor sensitivity setting interface.

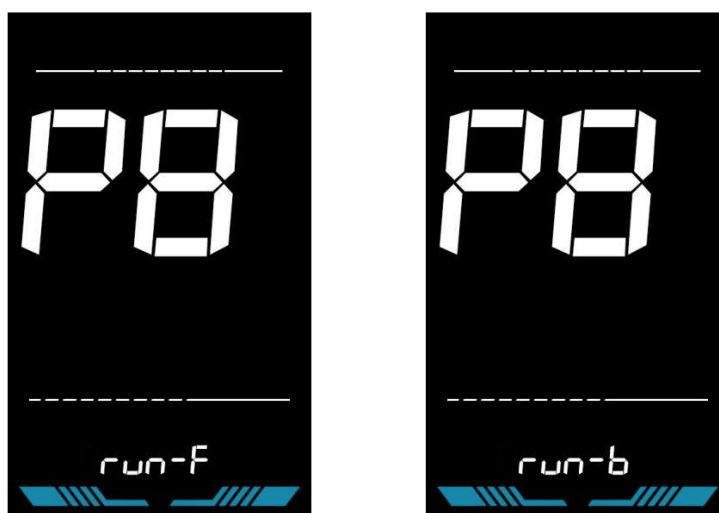

Figure 6-9 PAS sensor direction setting interface

6.8.2 PAS sensor sensitivity setting

SCN is the PAS sensor sensitivity setting. The adjustable range is: 2-9. 2 is the highest level sensitivity while 9 is the lowest.

Press the **+** / **-** to select the parameter and press **i** to save the parameter setting and enter into 6.8.3 PAS magnets number setting interface or long press **i** to return to the personalized parameter setting interface.



Figure 6-10 PAS sensor sensitivity setting interface

6.8.3 Number of pedal assist sensor magnets setting

PR5 is the pedal assist sensor magnets setting. The adjustable range is: 5-31.

Press the **+** / **-** to select the parameter and press **i** to save the parameter setting and **←** to return to the personalized parameter setting interface.



Figure 6-11 Pedal assist sensor magnets setting

6.9 Throttle setting

P9 is the throttle setting.

6.9.1 Throttle 6KM/H walk boost setting

HL is the throttle 6KM/H walk boost setting. HL-Y is to enable the walk boost and the speed will maintain at 6KM/H when using throttle. HL-N is to disable the walk boost and it can reach the max speed when using throttle.

Press the **+** / **-** to select the HL-Y and press **i** to save the parameter setting and return to the personalized parameter setting interface.

Press the **+** / **-** to select the HL-N and press **i** to save the parameter setting and enter into 6.9.2 Throttle Level setting interface or long press **i** to return to the personalized parameter setting interface.

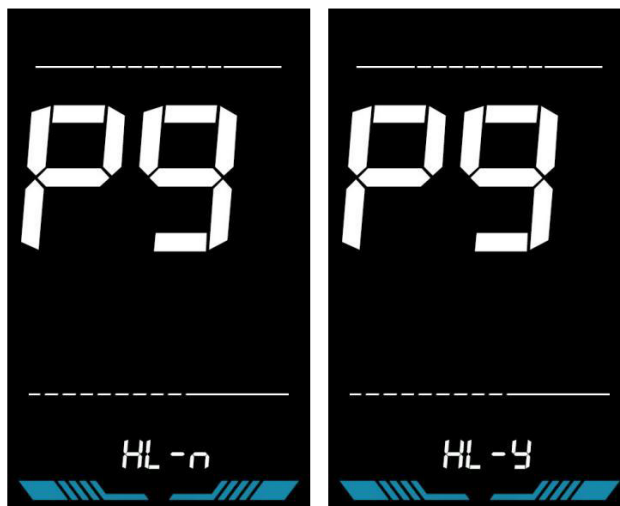

Figure 6-12 Throttle 6KM/H walk boost setting

6.9.2 Throttle level setting

HF is the throttle Level setting. HF-Y is to enable the throttle level. When using the throttle, the max speed depends on the throttle level. (0~3, 1~3, 0~5, 1~5, 1~7, 0~7, 0~9, 1~9) HF-N is to disable the throttle level. The speed is independent with the throttle level and can reach the rated max speed.

Press the **+** / **-** to select the parameter and press **i** to save the parameter setting and to return to the personalized parameter setting interface.

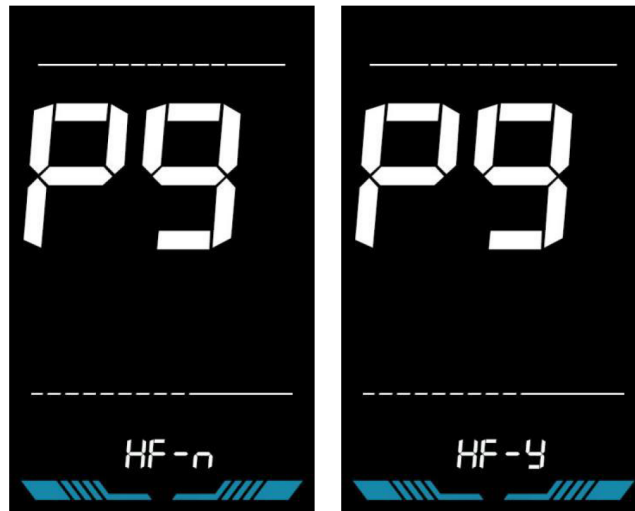

Figure 6-13 Throttle level setting

6.10 Power-on password setting

PA is the power-on password setting. The power-on password is not activated by default but users can activate it from setting PSd-y. The factory default password is 1212. Users can set other four-digit password. Please keep the password in mind after changing it, otherwise you will not be able to use the display.

Press **i** to enter the parameter changing state. Press the **+** / **-** to select the parameter. PSd-y means the power-on password is activated while PSd-n is off. Press **i** to confirm the mode and enter the state of setting the four digits power-on password or exit to the personalized parameter setting interface.



Figure 6-14 Power-on Password OFF interface



Figure 6-15 Power-on Password Activated interface

In the password setting mode, the adjustable digit will flash. Press the **+**/**-** to select the parameter and press **i** to save the numbers and go to the next digit setting. Long press **i** to save the parameter setting and return to the personalized parameter setting interface after finish setting the four digits in turn.



Figure 6-16 Power-on password setting interface

6.11 Auto Sleep Time Setting

Pb is the auto sleep time setting. To save the battery power and reach higher range, this display will be turned off after it has not been used for a time. The adjustable range is: 1~60min, 00 means no auto shutdown. The factory default setting is 10 minutes.

Press **i** to enter the parameter changing state. Press the **+**/**-** to select the parameter and press **i** to save the parameter setting and return to the personalized parameter setting interface.



Figure 6-17 Auto Power Off Time Setting Interface

7. Shortcut operation

7.1 Restore factory settings operation

dEF is the restore factory default parameter settings. dEF-Y is to restore the factory default settings, and dEF-N is not to restore.







Enter into the main setting interface and keep the speed at 0, press and hold  and  simultaneously for 2s to enter the restore factory default setting interface. Pressing  /  to toggle to dEF-Y. Then after pressing  to confirm, the display will show dEF-0 for a few seconds and then automatically start to restore the factory default settings. The display will automatically exit to setting interface after the restoration.



Figure 7-1 Restore Factory Default Settings Interface

7.2 Trip odometer reset operation

The display can record trip odometer and odometer. Trip odometer is not automatically reset after turning off. The trip odometer needs to be reset manually. The odometer can not be reset.

Enter into the main setting interface and keep the speed at 0, press and hold  and  simultaneously for 2s to reset the trip odometer. The main interface will flash during the reset process.

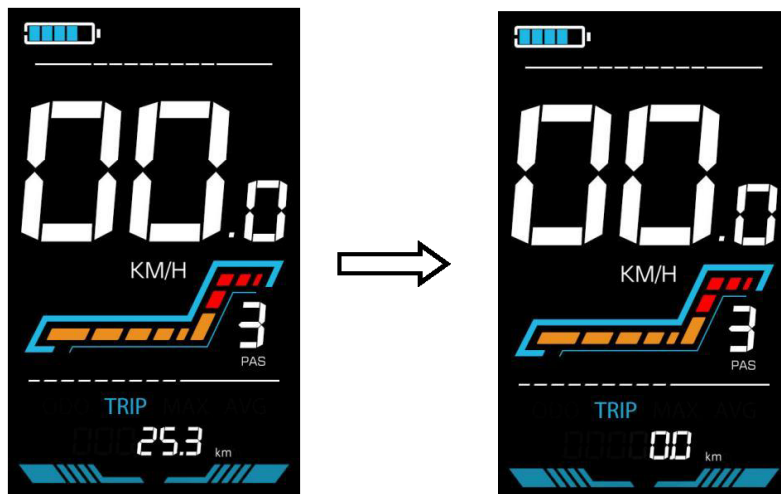

Figure 7-2 Trip Odometer Reset Interface

8. Quality Assurance and Warranty

8.1 Warranty info

● Yolín will offer a limited warranty for any failure caused by the product defects under normal use during the warranty period.

- The product is warranted for 12 months from the date out of factory.

8.2 Warranty does not cover

- The shell is opened.
- The connector is damaged.
- Scratches on the appearance after the product is out of factory.
- Scratched or broken wires
- Failure or damage caused by force majeure (e.g. fire, earthquake, etc.) or natural disaster (e.g. lightning strike, etc.)
- Out of warranty period.

9. Wire connection diagram

9.1 Standard wire connection sequence

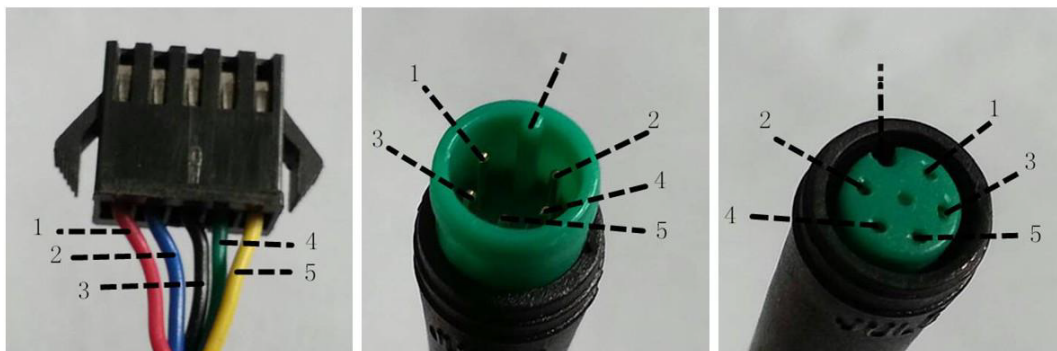

Controller connector

Display connector (Female terminal) Display connector (Male terminal)

Figure 9-1 Wire Connection Diagram

Table 9-1 Standard connector wire sequence table

Standard Wire Sequence	Standard wire color	Function
1	Red (VCC)	Display power wire
2	Blue (Kp)	Controller power wire
3	Black (GND)	Display ground wire
4	Green (RX)	Display data reception wire
5	Yellow (TX)	Display data transmit wire

■ Some models are equipped with waterproof connectors and the color inside wires can not be seen.

10. Precautions

Pay attention to all the general operating when using the products and do not plug and unplug the display while it is powered on.

- ◆ Avoid bumping the display as much as possible.
- ◆ Please do not change the parameter settings at will, otherwise normal riding cannot be guaranteed.
- ◆ If display does not work properly, please send it to the repair center as soon as possible.
- ◆ There may be differences between the physical products and this manual due to normal upgrade. Please refer to the physical products.

Schedule 1: Error Code Definition

YL-01, YL-02 Error codes				
Error code	Definition		Error code	Definition
E001	Controller failure		E004	Throttle failure
E002	Communication failure		E005	Brake failure
E003	Hall failure		E006	Motor phase failure
YL-05, KDS, YL-J Error codes				
Error code	Definition		Error code	Definition
E021	Current failure		E024	Hall failure
E022	Throttle failure		E025	Brake failure
E023	Motor phase failure		E030	Communication failure

Schedule 2: Pedal assist level default ratio value

Level selection \ Level	Level								
	1	2	3	4	5	6	7	8	9
0-3/1-3	50%	74%	92%	-	-	-	-	-	-
0-5/ 1-5	20%	40%	60%	80%	100%	-	-	-	-
0-7/ 1-7	40%	50%	60%	70%	80%	90%	96%	-	-
0-9/ 1-9	25%	34%	43%	52%	61%	70%	79%	88%	96%

Safety

These safety precautions are provided for your benefit to protect you and those around you. Please read and follow them carefully to avoid unnecessary injury, damage to the product, or damage to other property.

Battery

CAUTION

- Do not throw the battery into a fire. Do not overheat the battery.



- Do not connect the battery to other appliances other than your battery.

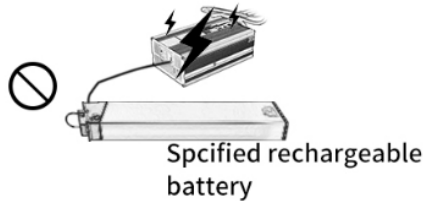

- Use only the specified charger to charge the battery.



- Do not take apart or modify the battery.



- Do not connect positive and negative terminals by using metallic objects.

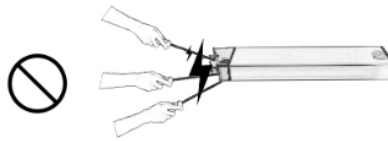

(Elcclrolyle leakage, overheating and/or rapture may result in this type of abuse.)

Battery Charger

CAUTION

- Do not take apart or modify the charger



- Do not subject the charger to shocks, e.g. by dropping. Keep the charger away from water



- Do not touch the charger with your skin for long periods during charging

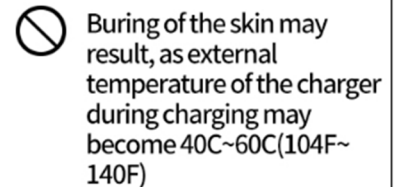

Overheating, fire or electric shock may result

- Do not cover the charger or place objects on it

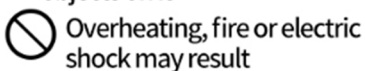

- Place the charger firmly on a flat dry surface

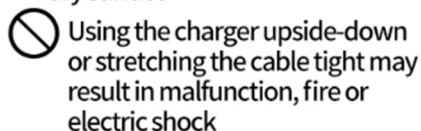

- Do not short-circuit the terminals by using metallic objects

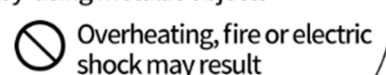

⚠ WARNING

- Keep the battery away from water. Pouring water on the battery may result in short-circuit, overheating or permanent damage of the battery.
- Do not submerge the battery. Soaking the battery in water may cause irreparable damage.

⚠ WARNING

- Do not apply pressure to the cable or the plug.
 - ⊘ Placing the cable tightened between a wall and a window frame, or placing heavy objects on the cord or the plug may result in electric shock or fire.
- Be sure to insert the plug securely into a wall socket.
 - ⊘ Electric shock and overheating may result, causing fire.
- Do not touch the plug with wet hands.
 - ⊘ Electric shock may result.
- Keep out of reach of children or pets.
 - ⊘ Electric shock or injury may result.
- Do not attempt to use another maker or model's charger to charge the battery.
 - ⊘ Overheating, fire or electric shock may result.
- Do not use the charging plug and/or the power source Plug when they are dirty, wet or dusty.
 - ⊘ Insulation failure due to moisture absorbed in the dust may result, causing fire.
 - Pull out the power source plug and clean it with a dry cloth.
- To remove a cable from a socket, pull the plug, not the cable.
 - ⊘ Always pull the charging cable gently.
- Do not rotate the pedals when charging the battery while it is mounted on the bicycle.
 - ⊘ The cord may twist around the pedal or the crank, and the damage to the plug may result, causing electric shock or fire.
- Do not apply voltage over the rated value to the charger.
 - ⊘ Do not use sockets, correctors and other wiring devices with a power source other than standard rated voltage (AC110-240 volts) power supply.
 - Overheating, fire or electric shock may result.
- Do not use damaged components such as charge case, power cord, plug etc.
 - ⊘ Electric short, short-circuit or fire may result.

Trouble Shooting

As one or more causes of failure might lead to the failure phenomenon, you should find out the true cause(s) and then take the appropriate solution(s) to rectify the problem. In case of doubt, please consult a qualified technician for service, repairs or maintenance.

Failure Phenomena	Causes of Failure	Solutions
<ul style="list-style-type: none"> Can't turn on the e-bike 	<ul style="list-style-type: none"> Battery is off The Battery is out of power Battery aging or damaged Poor contact of display line Failure of controller Failure of switch 	<ul style="list-style-type: none"> Turn on the battery Fully charge the battery Replace the battery Reconnect the display Replace the controller Replace the switch
<ul style="list-style-type: none"> Pedal assist doesn't work Gear doesn't work well Brake doesn't work well Display doesn't light on 	<ul style="list-style-type: none"> Failure of speed sensor Rear derailleur mismatch Brake caliper mismatch Brake Disc is bent Poor contact of display line 	<ul style="list-style-type: none"> replace speed sensor Adjust rear derailleur Adjust brake caliper or disc Reconnect the display line
<ul style="list-style-type: none"> Can't adjust the speed Speed is less than 10km/h 	<ul style="list-style-type: none"> Battery's voltage is too low Throttle governing bar is damaged Poor contact of the controlling line Spring failure or being locked 	<ul style="list-style-type: none"> Fully charge the battery Replace the throttle governing bar Replace the spring
<ul style="list-style-type: none"> e-Bike's mileage is obviously inadequate after fully charged 	<ul style="list-style-type: none"> Inadequate tire pressure Failure of charger The battery cannot be fully charged Failure of controller Battery aging or battery damaged e-Bike has not been well assembled Too much upgrade road Strong wind Bad road Overweight Too many braking times Temperature is too low 	<ul style="list-style-type: none"> Inflate tire with appropriate air pressure Repair the charger Examine and repair the controller Replace the controller Replace the battery Re-adjust the e-Bike <ul style="list-style-type: none"> Boost the e-Bike by manpower Warm the battery above 0°C (32°F)
<ul style="list-style-type: none"> Wheel hub stop running after switching on the power 	<ul style="list-style-type: none"> The connection of battery is loosen. Poor contact of controlling line The connection of wheel hub is loose or damaged The protective board of the battery is broken 	<ul style="list-style-type: none"> Re-connect the battery Replace the connection line Replace the battery's protective board with a new one



Company: Guangzhou Weitianlan E-commerce Trade Co., Ltd.
Address: Room 202, No.4, Ivgang Fifth Street, Huadu District,
Guangzhou, Guangdong, china

Email: support@vitilanebike.com

Website: vitilanebike.com

Facebook: Vitilanebike

Youtube: Vitilanebike

Instagram: Vitilanebike

Twitter: Vitilanebike