

PLAN / TOP ELEVATION

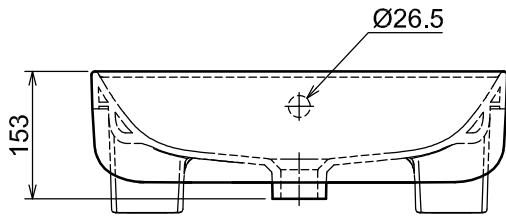

FRONT ELEVATION

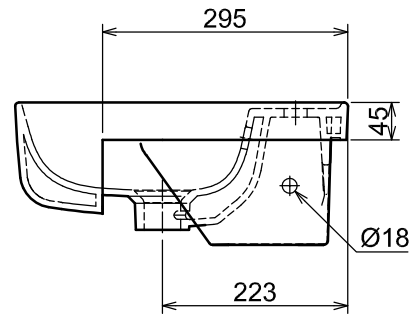

SIDE ELEVATION

WBFC 8778 SR