



NON-ELECTRIC FLUID-DRIVEN DOSING PUMPS FOR  
**WATER TREATMENT**

**CHLORINATION**

**WASTE WATER TREATMENT**



**DOSATRON**®

*Because life is powered by water*



Shop Dosing Pump & more at  
[www.theindustrialshop.com](http://www.theindustrialshop.com)



### Our mission

Dosatron provides high quality equipments for the treatment of fluids, service excellence, a high level of expertise and customer proximity worldwide.

### Our ambition

Our ambition is to offer simple, clear, reliable and sustainable solutions to help you meet your challenges of today and tomorrow.

### Our vision

We want to be an actor in your designs and projects and actively participate in the development of your knowledge and solutions.

The technical expertise and customer proximity are the cornerstones of our vision. DOSATRON is committed to guarantee a quick and entirely customized service to your special needs, and maintain a continuous dialogue based on trust, listening and recommendation.

# COMPANY

An international presence in more than 100 countries

### Environment

- Water consumption control:
  - ▶ 25% reduction in water consumption.
- Energy control:
  - ▶ 20% reduction in site energy consumption.
- Waste recovery/treatment:
  - ▶ more than 60% of waste produced is recycled.

### Quality

100% of products tested. Monitoring and traceability of all parts and products assembled during the manufacturing process. A close and mutually beneficial partnership with DOSATRON's suppliers so as to ensure higher quality of purchased components. Visual and synthetic methods for monitoring production problems (Delays, Quality, Maintenance of Equipment, Staff Competence, etc.) in real time.



### Safety

For DOSATRON, the safety of its staff and its partners is a high priority. Action taken by the company's Quality Safety Environment service is intended to prevent and control all risks on site and for the associated activity. All the company's employees, regardless of their occupation and role, are the driving force behind, and are involved in the process.

By carrying out an ergonomic study of the current situation, DOSATRON has been able to design tailored tools and work stations, thereby reducing the severity of working conditions.

### Ecodesign

By broadening the scope of its ISO 14001 certification and by integrating the activities of Design and development, DOSATRON can now pride itself on implementing a true Ecodesign process. This step has allowed the company to understand the entire life cycle of its product and thus to find solutions to limit the associated environmental impact.

## DOSATRON, INNOVATION BORN OUT OF EXPERIENCE



The company born of an invention

A universal spectrum of skills

Innovating for your development

Technological design is our hallmark  
The mains supply service is our solution

## DOSATRON Technology

Dosatron technology is based on a **hydraulic motor pump activated only by pressure and the flow of the water**. Installed directly on the water supply line, the Dosatron operates by using the **water flow rate as a source of energy**. The pressure and flow rate of the water actuate the motor piston which drives a second, product dosing piston. The product is injected and mixed continuously with the water from the mains supply at the selected dosing rate % (rate of product/water incorporation). **The dose of concentrated product is directly proportional to the volume of water which passes through the Dosatron, independently of variations in the flow rate and pressure of the mains water supply.**

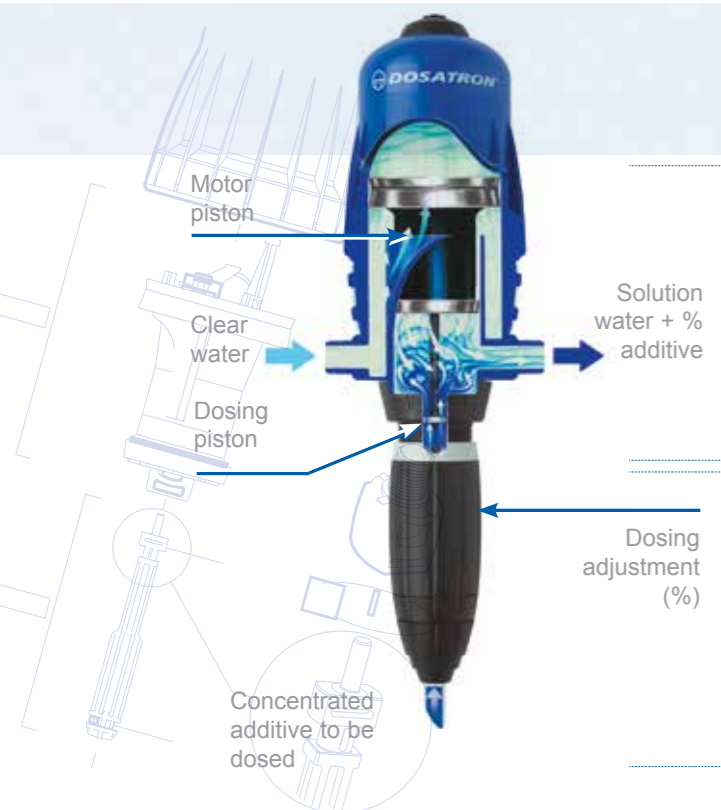

### ■ The hydraulic motor

The motor piston moves under the pressure of the water. A system of valves allows the movement to be reversed.

Each piston cycle corresponds to a predetermined volume of water which passes through the pump (motor volume). The speed of the motor varies proportionally with the flow of water.

The dosing pump is called a **VOLUMETRIC pump**.

### ■ The dosing assembly

The Dosing piston driven by the motor continuously injects a fixed volume of product (adjustable capacity of the dosing body). The dosing piston will inject the quantity of product that corresponds to the volume of water passing through the motor. Therefore, the operating principle ensures constant dosing, independently of the variations in flow rate and pressure of the water.

The injection of the product is **PROPORTIONAL** to the water flow rate.

### ■ The perfect solution at your service...

- ▶ For metering the amount of chemical solution.
- ▶ For a constant solution with a proportional, accurate and homogeneous dosage.
- ▶ For facilities without electricity or in difficult or technical environments.
- ▶ For a reasonable cost, ease of installation, for a significant and immediate added value and productivity.

### ■ The universal solution

- ▶ Pure core business: **"Dosing Solutions Specialists"**
- ▶ Our core Market: **Water Treatment, Hygiene, Environment, Industry...**

## PROPORTIONAL DOSING WITHOUT ELECTRICITY



Dosatron technology is based on a hydraulic motor pump activated only by pressure and the flow of the water.

Dose any liquid or water-soluble product

Multiple applications, one solution

High precision & repeatability dosing





## CHLORINATION FOR RURAL AREAS OR EMERGENCIES

It is estimated that 2.6 billion people do not have satisfactory access to drinking water.

The production of drinking water in rural areas or in emergencies requires reliable equipment that is suitable for sometimes extreme conditions (lack of electricity, local constraints).

# CHLORINATION



**DOSATRON meets your needs**

**Purification without electricity  
for rural communities or emergencies ◀**

**Daily volume of water from 1 m<sup>3</sup> to 300 m<sup>3</sup> ◀**

**Flow rate of water from 1 m<sup>3</sup>/h to 100 m<sup>3</sup>/h ◀**

**Pressure of water in the mains supply from 0.5 to 10 bar ◀**

## A SOLUTION FOR YOUR CHLORINATION NEEDS



Purification  
without electricity.

Reliable and  
suitable equipment.

Production  
of drinking  
water.

Low operating and  
maintenance costs.

Water as the only  
source of energy.



**Chlorination upstream of the point of consumption or re-chlorination (rural communities or emergencies)**

- Water disinfection (bactericidal, virucidal, fungicidal) with residual protection against potential low levels of post-treatment contamination
- Easily measurable chlorine concentration
- Easy-to-implement solution
- Low-cost and locally available supplies
- Proven technique

**Advantages**

- ▶ Operates with water pressure - **Non-Electric.**  
No additional fees for installation
- ▶ Compatible with low gravitational pressure (reservoirs, hills, mountain springs)
- ▶ The precision is not dependent on the water pressure or the flow rate of the mains supply
- ▶ Injection rate **easy to regulate**
- ▶ Easily repeatable injection rate
- ▶ **Easy maintenance at the installation site**
- ▶ Portability (Emergency Skids)
- ▶ Self-priming (even in the case of degassing)
- ▶ Non-Pulsating (Operates with, not counter to, the water pressure)
- ▶ Low operating and maintenance costs

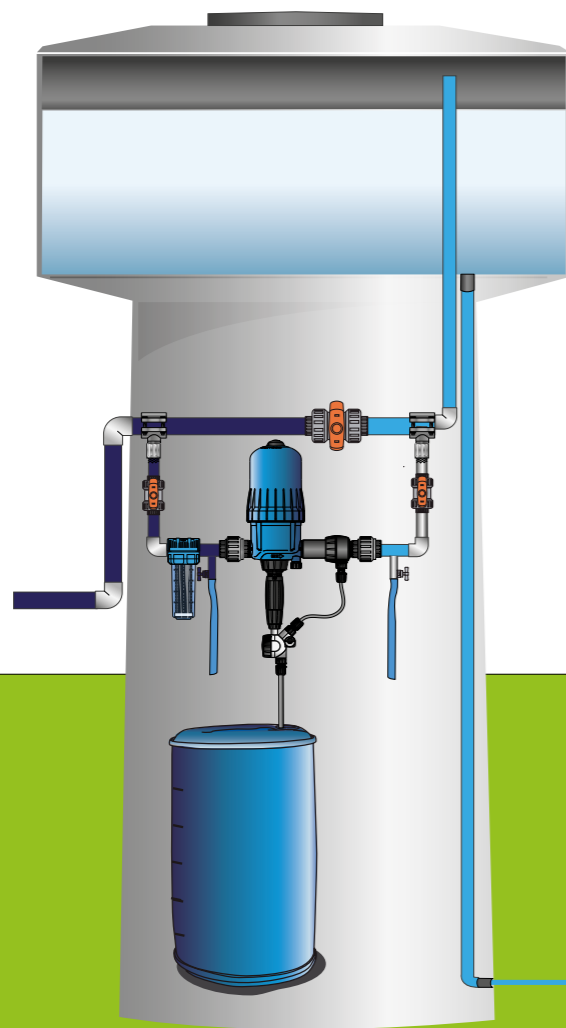
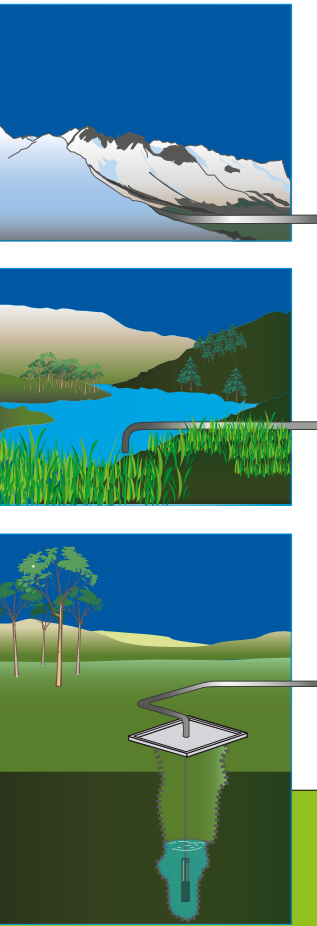

RURAL COMMUNITIES OR EMERGENCIES



Operates with water pressure. Non electric.

Compatible with low gravitational pressure.

The precision is not dependent on the water pressure or the flow rate of the mains supply

Injection rate easy to regulate.

Easily repeatable injection rate.



## ■ Calculation\*: Installation in partial Bypass mode

A part of the flow passes through the dosing unit; makes it possible to treat higher daily flow rates and volumes of water (up to 5x higher).

Example chlorine powder:

$V_D = 20 \text{ m}^3$   
 $Q_T = 5000 \text{ l/h}$   
 $Q_P = 1000 \text{ l/h}$   
 $D\% = 0.5 \%$   
 $C_H = 65 \%$  (CaClO)  
 $C_{CL2} = 2 \text{ ppm}$

Method for preparing the stock solution

The concentration of active chlorine to be achieved at the outlet of the installation is  $C_{CL2}$  i.e. 2 ppm (or mg/l):

• Adjustment of the dosing unit  $D\% = 0.5\%$  i.e. an injection ratio of  $100/0.5 = 200$

• Flow rate division ratio  $R_Q = 5000/1000 = 5$

• Concentration of active chlorine  $C_M$  in the solution tank:

$2 \text{ mg/l} \times 5 \times 200 = 2000 \text{ mg}$  i.e. 2 g/l

• Daily volume passing through the bypass  $V_P = 20/5 = 4 \text{ m}^3$

• Daily volume of solution to be prepared  $V$ : 0.5% of  $V_P$  i.e.  $0.5\% \times 4 \text{ m}^3 = 20 \text{ litres}$

• Mass of active chlorine in the solution  $C_M \times V$  i.e.  $2 \times 20 = 40 \text{ g}$

• Mass of product to be diluted  $M_H$  to prepare the solution:  $40 / 65 \times 100 = 61.5 \text{ g}$  of chlorine at 65%

Conclusion

For 61.5 g of hypochlorite at 65% into the stock solution tank and add water up to 20 litres. Adjust the dosing unit to 0,5%.

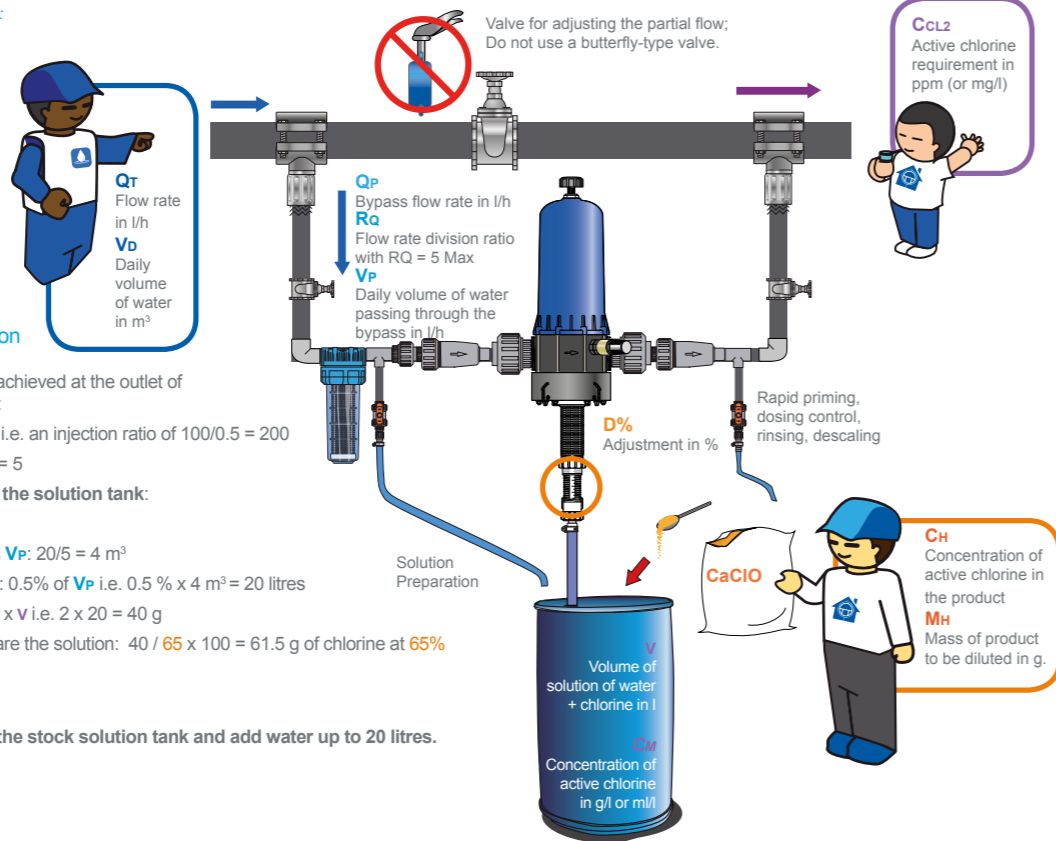

## ■ Calculation\*: Installation in full Bypass mode

100% of the flow of water passes through the dosing unit. Compatible with variable flow rates of water.

Example liquid chlorine:

$V_D = 20 \text{ m}^3$   
 $Q_T = 5000 \text{ l/h}$   
 $D\% = 0,05 \%$   
 $C_H = 10 \%$  (NaClO)  
 $C_{CL2} = 2 \text{ ppm}$

Method for preparing the stock solution

The concentration of active chlorine to be achieved at the outlet of the installation is  $C_{CL2}$  i.e. 2 ppm (or mg/l):

• Adjustment of the dosing unit  $D\% = 0.05\%$  i.e. an injection ratio of  $100/0.05 = 2000$

• Concentration of active chlorine  $C_M$  in the solution tank:  $2 \text{ mg/l} \times 2000 = 4000 \text{ mg}$  i.e. 4 g/l

• Daily volume of solution to be prepared  $V$ : 0.05% of  $V_D$  i.e.  $0.05\% \times 20 \text{ m}^3 = 10 \text{ litres}$

• Dilution ratio  $RD = C_H \times 10 / C_M$  i.e.  $RD = 100/4 = 25$

• Volume of product to be diluted  $V_H$  to prepare the solution:  $10/25 \times 1000 = 400 \text{ ml}$  of chlorine at 10%

Conclusion

For 400 ml of hypochlorite at 10% into the stock solution tank and add water up to 10 l. Adjust the dosing unit to 0.05 %.

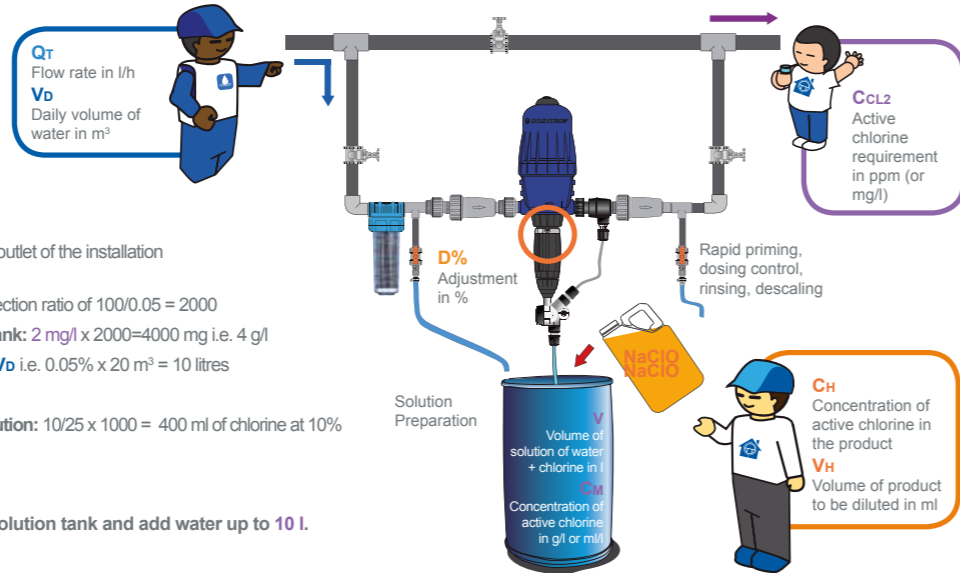

\*This example of calculation is for information only and Dosatron cannot be held responsible for any direct or indirect damage resulting from its use. In particular DOSATRON INTERNATIONAL SAS does not guarantee the correctness and completeness of this information. The information is given in its present state and without any guarantee. For more information, please contact us.

## ■ Chlorination software



Dosatron has software for helping to choose dosing pumps, to install them and to calculate chlorination. Contact us.

### Recommandations



- Chlorine degrades much more quickly in light. The solution tank should be made of dark plastic material, provided with a non-airtight lid. The installation should be positioned in a control room, in darkness, ventilated and protected from vandalism.

- Please respect local legislation relating to the purification of water.

- Ensure the minimum contact times necessary for ensuring a bactericidal and virucidal effect.

- With hard water, do not exceed a concentration of 1g/l of active chlorine in the stock solution injected by the Dosatron D20WL2.

- With hard water, do not exceed a concentration of 10g/l of active chlorine in the stock solution injected by Dosatron WL3000IE.

## Recommended models:

The main flow rate and the daily volume of water to be treated determine the choice of range.



### D3WL3000IE

Water flow : 10 to 3 000 l/h  
 Operating pressure : 0.3 to 6 bar  
 Dosage : 0.03 to 0.3%  
 Concentrated additive injection : 0.003 to 9 l/h



### D8WL3000IE

Water flow : 500 to 8000 l/h  
 Operating pressure : 0.15 to 8 bar  
 Dosage : 0.03 to 0.125 %  
 Concentrated additive injection : 0.15 to 10 l/h



### D20WL2

Water flow : 1000 to 20 000 l/h  
 Operating pressure : 0.12 to 10 bar  
 Dosage : 0.2 to 2 %  
 Concentrated additive injection : 2 to 400 l/h

## INSTALLATION KIT

(Please contact us)

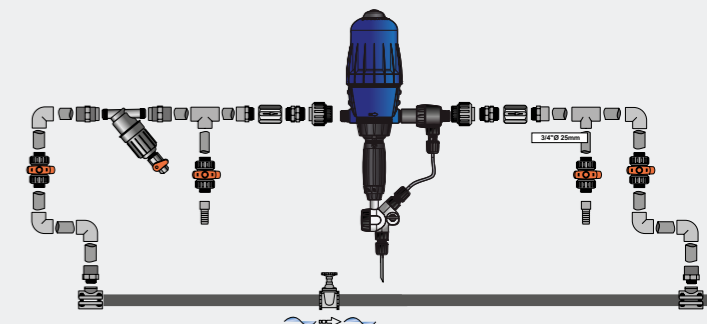

## INSTALLATION IN PARTIAL OR FULL BYPASS MODE





## SLUDGE DEWATERING & WASTE WATER FLOCCULATION

Traditional preparation of liquid polymer is carried out by means of integrated in-line dosing systems based on an electric pump (peristaltic pump, membrane pump) which some time includes mixers and other options.

With the Dosatron Non Electric Proportional Dosing Pumps reliable dosing & mixing regardless water flow & pressure variations have been integrated in an efficient & compact technology.

# TREATMENT OF WASTE WATER



DOSATRON meets your needs

Preparation of liquid polymers ◀

*Sludge Dewatering*

*Waste Water Flocculation*

DISTRICTS, INDUSTRIES, ...



No electricity  
(energy saving).

Easy dosage  
adjustment (in %).

Good precision  
/ repeatability.

Self priming &  
efficient mixing.

Optimal water &  
polymerconsumption.

## Example of Sludge Dewatering installation

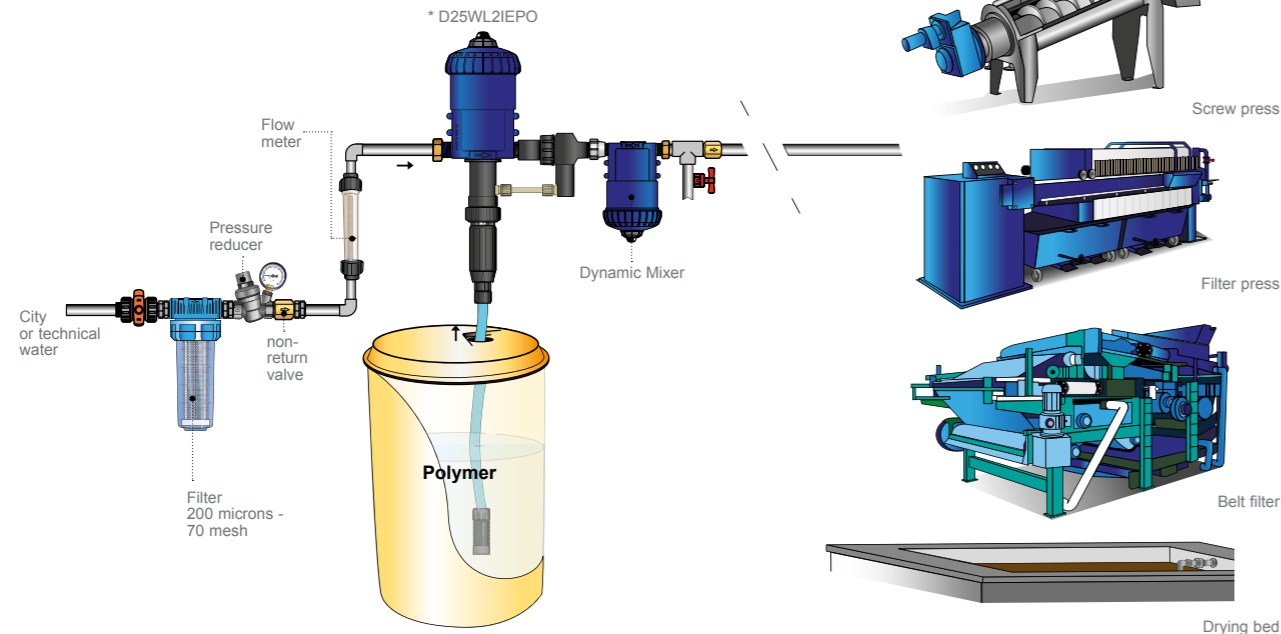

### Advantages

- ▶ No electricity (energy saving)
- ▶ Easy dosage adjustment (in %)
- ▶ Good precision / repeatability
- ▶ Self priming & efficient mixing
- ▶ Optimal water & polymer consumption
- ▶ Reduced cleaning & maintenance time
- ▶ Low cost service & installation
- ▶ Security : if the water flow stops, the polymer dosing stops automatically.

### Recommended models:

Depending on the type and viscosity of the polymer: to be checked in the Chemical properties MSDS (consult us if in doubt).

### POLYMER UNIT 1 [PU1] D25WL2IEPO + DMIX25

Water flow : 10 l/h tot 2.5 m<sup>3</sup>/h  
 Operating pressure : 0.3 to 6 bar

External Injection  
 With a special self cleaning valve. Recommended for high viscosity anionic/cationic polymers to reduce the clogging risk & delay the pump cleaning.

### D25WL2IEPO

Water flow : 10 l/h to 2.5 m<sup>3</sup>/h  
 Operating pressure : 0.3 to 6 bar  
 Polymer dosage from: 0.2 % to 2 %

### DMIX25 Dynamic Mixer

Water flow : 10 l/h to 2.5 m<sup>3</sup>/h  
 Operating pressure : 0.3 to 6 bar

## Example of Waste Water Flocculation installation (after coagulation)

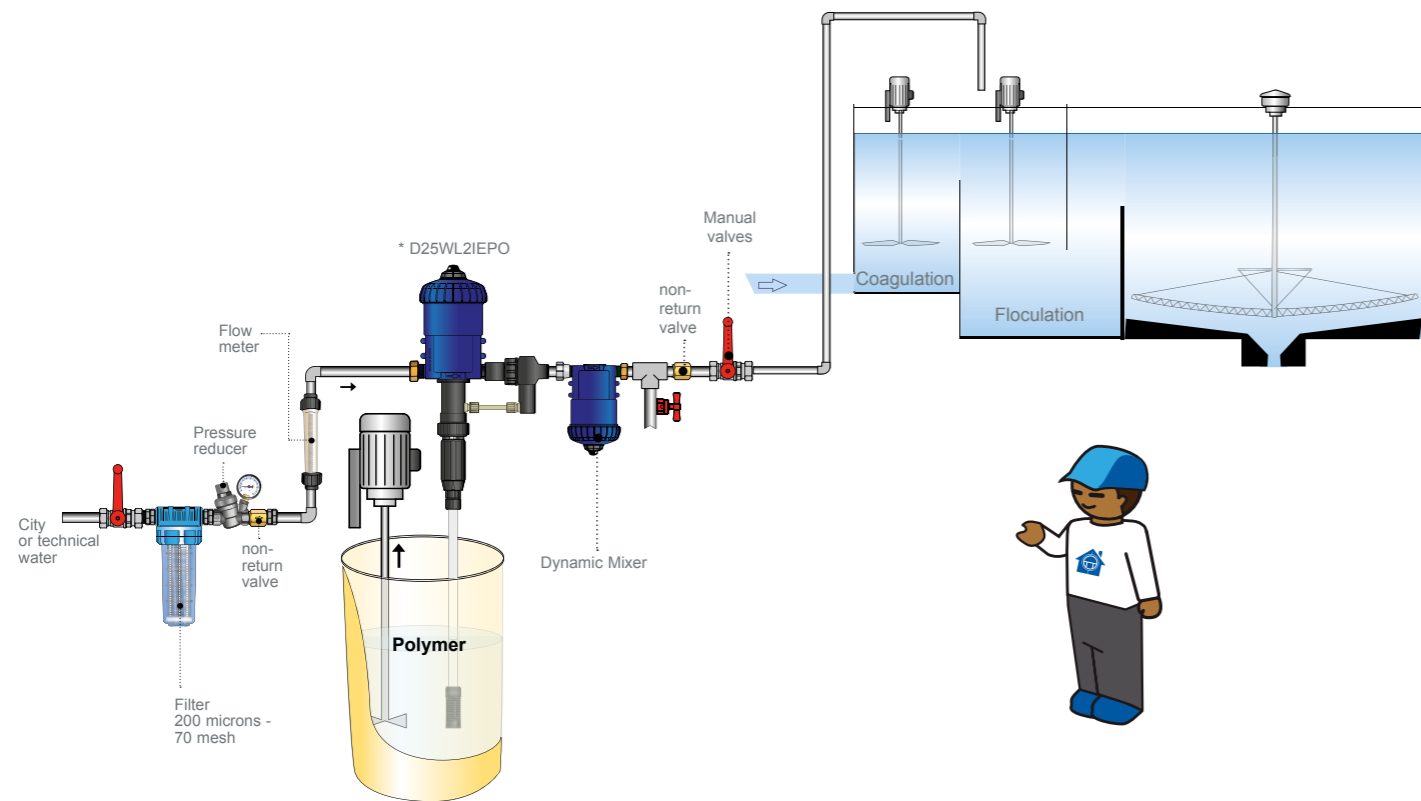

### Recommandations

- Check the viscosity level indicated in the MSDS of the polymer.
- Reduce as much as possible the Dosatron suction pipe length to limit the viscosity effect on the dosage.
- A Dosatron Dynamic Mixer can be added after the Dosatron pump to improve homogeneity (Maxi water flow: 2.5 m<sup>3</sup>/h).
- A Maturation tank may be required after the Dosatron specially for anionic polymers (see with your polymer supplier).
- Protect the polymer from temperature changes.
- For unstable polymers (particularly anionic polymers) an electric stirrer may be added into the liquid polymer drum.
- Adjust the water flow level & the polymer dosing rate on the Dosatron to optimize the polymer efficiency.

## SLUDGE DEWATERING & WASTE WATER FLOCCULATION







- Potable water systems
- Water mineralization
- Legionella treatment
- Micro, Ultra filtration & RO disinfection
- Water system maintenance & disinfection
- Press filter cleaning
- Polymers dosing
- Odor control
- Etc.

To download  
**DOSATRON**  
app for free



OR

Available on the  
**App Store**

Get it on  
**Google play**



Downloaded from theindustrialshop.com

**DOSATRON INTERNATIONAL S.A.S.**

Rue Pascal - B.P. 6 - 33370 TRESSES (BORDEAUX) - FRANCE  
**Tel. 33 (0)5 57 97 11 11 - Fax. 33 (0)5 57 97 11 29 / 33 (0)5 57 97 10 85**  
**e.mail : info@dosatron.com - http://www.dosatron.com**

This document does not constitute a contractual obligation and is for information purposes only. DOSATRON INTERNATIONAL reserves the right to make changes to its products at any time. © DOSATRON INTERNATIONAL S.A.S. 2015