

EN

Hereby, Thousandshores Deutschland GmbH declares that the radio equipment type Wireless Headphones BTH16 is in compliance with Directive 2014/53/EU.

The full text of the EU declaration conformity is available at the following internet address: [Http://files.iclever.com/BTH16-DOC-EN.pdf](http://files.iclever.com/BTH16-DOC-EN.pdf)

DE

Hiermit erklärt Thousandshores Deutschland GmbH, dass der Funkanlagentyp Wireless Headphones BTH16 der Richtlinie 2014/53/EU entspricht.

Der vollständige Text der EU-Konformitätserklärung ist unter der folgenden Internetadresse verfügbar: [Http://files.iclever.com/BTH16-DOC-DE.pdf](http://files.iclever.com/BTH16-DOC-DE.pdf)

UK

Learn more about the UK Declaration of Conformity, Please click below link to download. [Http://files.iclever.com/BTH16-DOC-UK.pdf](http://files.iclever.com/BTH16-DOC-UK.pdf)



Wireless Headphones

Model: BTH16



User Manual

Contents

English User Manual	01
Benutzerhandbuch	12
Guide Utilisateur	22
Manual de Usuario	32
Manuale Utente	42
中文说明书	52

Package Contents



1 x iClever BTH16
Wireless Headphones



1 x User Manual



1 x 3.5mm Audio Cable



1 x USB Type-C Cable

Product Diagram

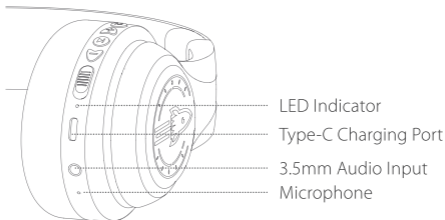
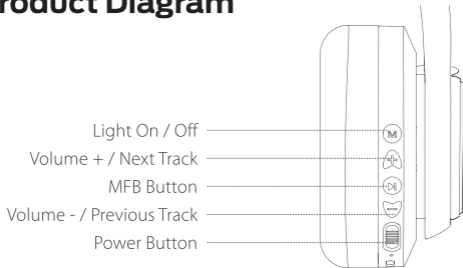

On / Off

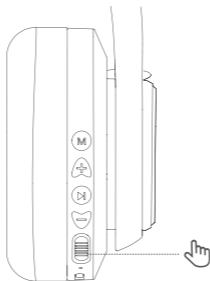

1. Power on: Switch the button to the "ON" direction. Then the LED indicator flashes blue for 1 second, and the colorful lights are on.
2. Shutdown: Switch the button to "OFF" direction, and the head-
phone is turned off. The LED indicator flashes blue for 1 second
and then goes off.

Bluetooth Pairing

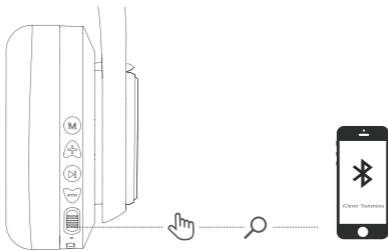

1. In the power-on state, switch the button to the "ON" direction; the colorful lights are on; Bluetooth enters the pairing state, and the red and blue lights flash alternately.
2. Turn on the Bluetooth of the mobile phone. Then find and select the "iClever Transnova" Bluetooth pairing name in the device list for Bluetooth pairing connection.

Light On / Off

Short press the "Light On / Off" button to turn on / off the light.

Volume Limit Gear Switching

1. Press and hold the "+" & "-" buttons at the same time to switch the volume limit to 74dB, and the voice broadcast to "74dB".
2. Press and hold the "+" & "-" buttons at the same time to switch the volume limit to 85dB, and the voice broadcast to "85dB".
3. Press and hold the "+" & "-" buttons at the same time to switch the volume limit to 94dB, and the voice broadcast to "94dB".

Operation of Buttons

Volume Up	Short press the "+" button.
Volume Down	Short press the "-" button.

Next Track	Press and hold the "+" button for 2 seconds.
Previous Track	Press and hold the "-" button for 2 seconds.
Play / Pause	Press the MFB button once.
Answer / End A Call	Press the MFB button once.
Reject A Call	Keep pressing the MFB button for seconds.
Activate Siri	Press the MFB button twice.
Clear The Pairing List	Press and hold the "+" button and "-" button simultaneously for 4 seconds in the power-on state to clear the pairing list. Then the headphone will automatically enter pairing state.

Voice Prompt

Power On	Power on
Power Off	Power off
Pairing	Pairing
Successful Pairing	Connected
Disconnection	Disconnected
Low Power	Battery Low

Specification

Frequency band	2.4GHz~2.482GHz
Maximum transmission power	4dBm

How to Charge the Headphone

Connect the Type-C cable to the Type-C port on the headphone, and a 5V power outlet (power adapter is not included). The indicator light will glow red to indicate charging. When the headphone is fully charged, the indicator light will change from red to blue.

Replacement Instruction of the Plate Cover

1. Lift the lid of earlap (similar to the bottle cap of a thermos bottle).

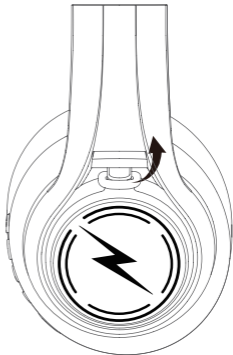

2. Remove the plate cover.

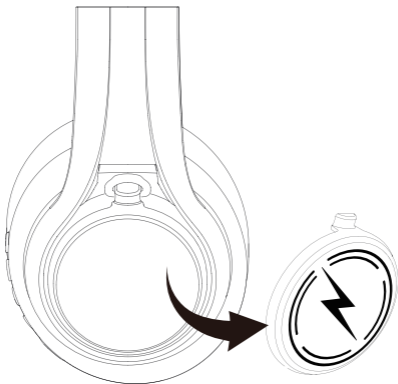

3. Replace with a new plate cover with earlap.

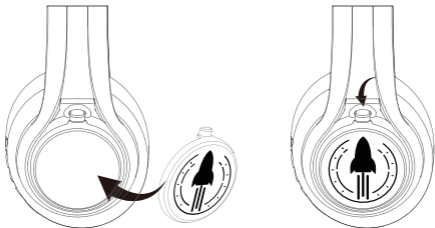

FCC Statement

Changes or modifications not expressly approved by the party responsible for compliance could void the user's authority to operate the equipment.

This equipment has been tested and found to comply with the limits for a Class B digital device, pursuant to Part 15 of the FCC Rules. These limits are designed to provide reasonable protection against

harmful interference in a residential installation. This equipment generates uses and can radiate radio frequency energy and, if not installed and used in accordance with the instructions, may cause harmful interference to radio communications. However, there is no guarantee that interference will not occur in a particular installation. If this equipment does cause harmful interference to radio or television reception, which can be determined by turning the equipment off and on, the user is encouraged to try to correct the interference by one or more of the following measures:

- Reorient or relocate the receiving antenna.
- Increase the separation between the equipment and receiver.
- Connect the equipment into an outlet on a circuit different from that to which the receiver is connected.
- Consult the dealer or an experienced radio/TV technician for help.

This device complies with part 15 of the FCC rules. Operation is subject to the following two conditions

- (1) This device may not cause harmful interference.
- (2) This device must accept any interference received, including interference that may cause undesired operation.

Lieferumfang



1 x drahtloser Kopfhörer
iClever BTH16



1 x Benutzerhandbuch



1 x 3,5-mm-Audiokabel



1 x USB-Kabel Typ C

Produkt Diagram

- Licht ein / aus
- Band + / Nächster Titel
- MFB-Taste
- Volume - / Vorheriger Track
- Ein / Aus-Taste

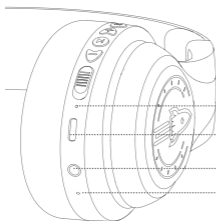

- LED-Anzeige
- Typ-C-Ladeanschluss
- 3,5-mm-Audioeingang
- Mikrofon

Ein / Aus

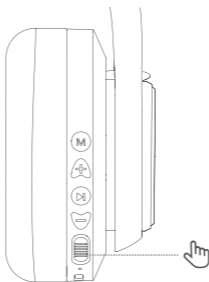

1. Einschalten: Schalten Sie die Taste in die Richtung "EIN". Dann blinkt die LED-Anzeige 1 Sekunde lang blau, und die bunten Lichter sind eingeschaltet.
2. Ausschalten: Schalten Sie die Taste in die Richtung "AUS", und der Kopfhörer ist ausgeschaltet. Die LED-Anzeige blinkt 1 Sekunde lang blau und erlischt dann.

Bluetooth Kopplung

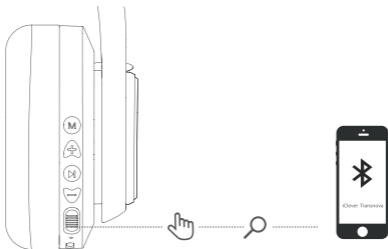

1. Schalten Sie die Taste im eingeschalteten Zustand in Richtung "ON"; die bunten Lichter sind eingeschaltet; Bluetooth geht in den Kopplungszustand über, und die roten und blauen Lichter blinken abwechselnd.
2. Schalten Sie das Bluetooth des Mobiltelefons ein. Suchen Sie dann den Bluetooth-Kopplungsname "iClever Transnova" in der Geräteliste für die Bluetooth-Kopplungsverbindung und wählen Sie ihn aus.

Licht On / Off

Drücken Sie kurz auf die Taste "Light On/Off", um das Licht ein-/auszuschalten.

Volume Limit Gear Switching

1. Halten Sie die Tasten "+" & "-" gleichzeitig gedrückt, um die Lautstärkebegrenzung auf 74dB und die Sprachübertragung auf "74dB" umzuschalten.
2. Halten Sie die Tasten "+" und "-" gleichzeitig gedrückt, um die Lautstärkebegrenzung auf 85 dB und die Sprachübertragung auf "85 dB" umzuschalten.
3. Halten Sie die Tasten "+" und "-" gleichzeitig gedrückt, um die Lautstärkebegrenzung auf 94dB und die Sprachübertragung auf "94dB" umzuschalten.

Bedienung der Schaltflächen

Volumen nach oben	Drücken Sie kurz auf die Taste "+".
Weniger Volumen	Drücken Sie kurz auf die Taste "-".

Nächster Track	Drücken und halten Sie die "+"-Taste 2 Sekunden lang.
Vorheriger Track	Drücken und halten Sie die Taste "-" 2 Sekunden lang gedrückt.
Abspielen / Pause	Drücken Sie die MFB-Taste einmal.
Einen Anruf annehmen / beenden	Drücken Sie die MFB-Taste einmal.
Einen Anruf ablehnen	Halten Sie die MFB-Taste 2 Sekunden lang gedrückt.
Siri aktivieren	Drücken Sie die MFB-Taste zweimal.
Die Kopplungsliste löschen	Halten Sie im eingeschalteten Zustand die "+"-Taste und die "-"-Taste gleichzeitig 4 Sekunden lang gedrückt, um die Paarungsliste zu löschen. Danach geht der Kopfhörer automatisch in den Kopplungszustand über.

Sprachaufforderung

Einschalten	Einschalten
Ausschalten	Ausschalten
Paarung	Paarung
Erfolgreiches Pairing	Verbunden
Trennung der Verbindung	Getrennt
Niedrige Leistung	Batterie schwach

Spezifikation

Begrenzung des Bandes	2.4GHz~2.482GHz
Maximale Übertragungsleistung	4dBm

Wie man den Kopfhörer auflädt

Schließen Sie das Typ-C-Kabel an den Typ-C-Anschluss des Kopfhörers und eine 5-V-Steckdose an (Netzadapter ist nicht im Lieferumfang enthalten). Die Anzeigeleuchte leuchtet rot, um den Ladevorgang anzuzeigen. Wenn der Kopfhörer vollständig aufgeladen ist, wechselt die Anzeigeleuchte von rot zu blau.

Austauschanweisung der Plattenabdeckung

1. Heben Sie die Ohrkappe (ähnlich dem Flaschenverschluss einer Warmhalteflasche).

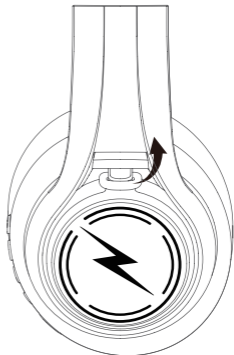

2. Entfernen Sie die Plattenabdeckung

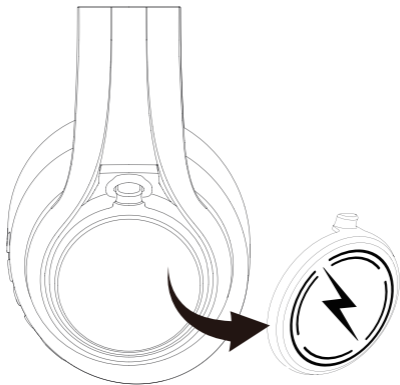

3. Ersetzen Sie dies durch eine neue Plattenabdeckung mit Ohrkappe.

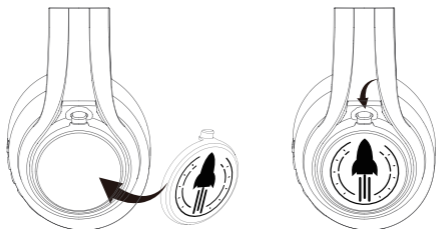

Contenu du paquet



1 x Écouteurs sans fil
iClever BTH16

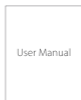

1 x Manuel d'utilisation



1 x Câble audio de 3,5 mm



1 x Câble USB de type C

Diagramme du produit

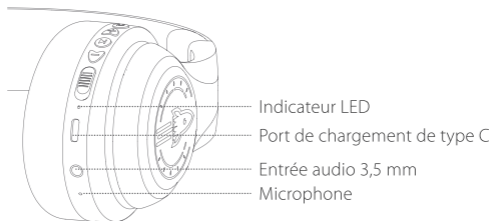
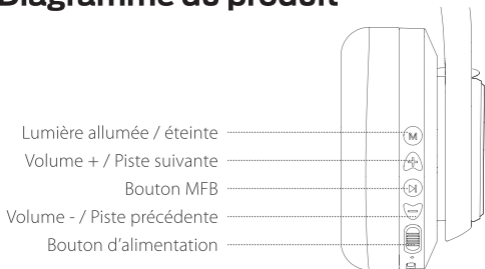

On / Off

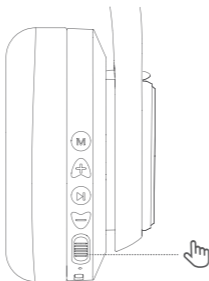

1. Mise en marche : Mettez le bouton dans le sens "ON". Ensuite, le voyant LED clignote en bleu pendant 1 seconde, et les lumières colorées s'allument.
2. Arrêt : Mettez le bouton dans le sens "OFF", et les écouteurs sont éteints. L'indicateur LED clignote en bleu pendant 1 seconde puis s'éteint.

Couplage Bluetooth

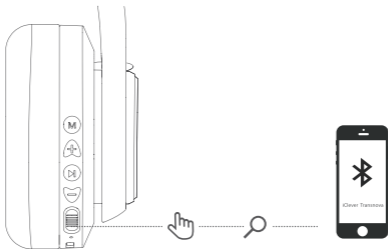

1. En état de marche, mettez le bouton dans le sens "ON" ; les lumières colorées sont allumées ; le Bluetooth entre en état de couplage, et les lumières rouge et bleue clignotent alternativement.
2. Allumez le Bluetooth du téléphone portable. Ensuite, trouvez et sélectionnez le nom de couplage Bluetooth "iClever Transnova" dans la liste des appareils pour la connexion Bluetooth.

Lumière Allumée / Eteinte

Appuyez brièvement sur le bouton "Light On/Off" pour allumer/éteindre la lumière.

Changement de limite du volume

1. Appuyez brièvement et maintenez les boutons "+" et "-" enfoncés en même temps pour passer la limite de volume à 74dB et la diffusion vocale à "74dB".
2. Appuyez brièvement et maintenez les boutons "+" et "-" enfoncés en même temps pour faire passer la limite de volume à 85dB, et la diffusion vocale à "85dB".
3. Appuyez brièvement et maintenez les boutons "+" et "-" enfoncés en même temps pour passer la limite de volume à 94dB, et la diffusion vocale à "94dB".

Fonctionnement des touches

Augmenter le volume	Appuyez brièvement sur le bouton "+".
Réduction du volume	Appuyez brièvement sur le bouton "-".

Prochain morceau	Appuyez sur la touche "+" et maintenez-la enfoncée pendant 2 secondes
Piste précédente	Appuyez sur le bouton "-" et maintenez-le enfoncé pendant 2 secondes
Reproduction / Pause	Appuyez une fois sur le bouton MFB
Répondre / Terminer l'appel	Appuyez une fois sur le bouton MFB
Rejeter l'appel	Maintenez le bouton MFB enfoncé pendant quelques secondes
Activer Siri	Appuyez deux fois sur le bouton MFB
Effacer la liste d'appariement	Appuyez simultanément sur le bouton "+" et le bouton "-" pendant 4 secondes lors de la mise sous tension pour effacer la liste d'appariement. Puis les écouteurs passeront automatiquement en mode appariement.

Commande vocale

Power On	Mise en marche
Power Off	Arrêt
Pairing	Couplage
Successful Pairing	Connection réussie
Disconnection	Déconnection
Low Power	Batterie faible

Spécifications

Gamme de fréquences	2.4GHz~2.482GHz
Puissance de transmission maximale	4dBm

Comment charger les écouteurs

Connectez le câble de type C au port de type C du casque, et à une prise de courant de 5V (l'adaptateur électrique n'est pas inclus). Le voyant lumineux s'allumera en rouge pour indiquer la charge. Lorsque les écouteurs sont complètement chargés, le voyant lumineux passe du rouge au bleu.

Procédure de remplacement de la housse des BTH16

1. Ouvrez le capuchon sur la coquille de l'oreille (comme la conception du capuchon du thermos)

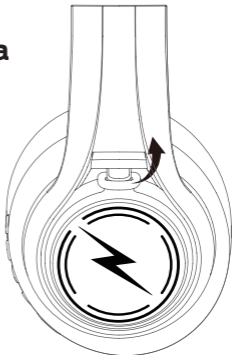

2. Retirez la housse inférieure

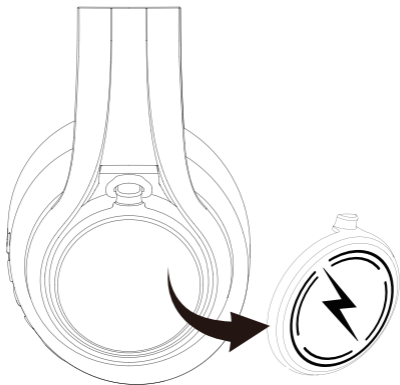

3. Remplacez-la par une autre housse pour coques d'oreilles

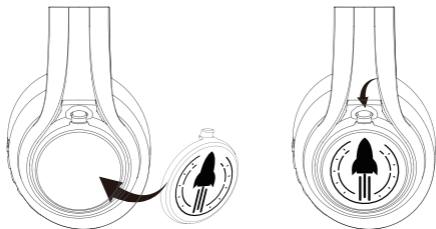

Contenido del paquete



1 x iAuriculares inalámbricos
iClever BTH16

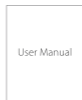

1 x Manual de usuario



1 x Cable de audio de 3,5 mm



1 x Cable USB tipo C

Diagrama del producto

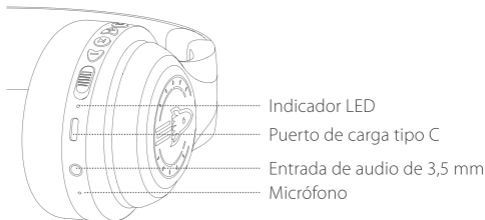
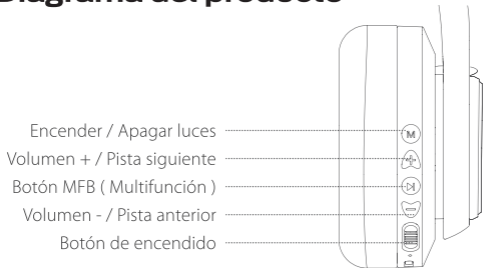

Encendido / apagado

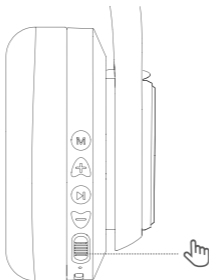

1. Encendido: Ponga el botón en posición "ON". Luego, el indicador LED parpadeará en azul durante 1 segundo y las luces de colores se encenderán.
2. Apagado: Cambie el botón a la posición "OFF" y los auriculares se apagarán. El indicador LED parpadeará en azul durante 1 segundo y luego se apagará.

Emparejamiento Bluetooth

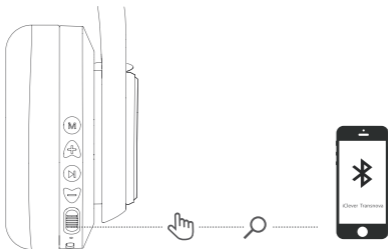

1. Con el auricular encendido, cambie el botón a la posición "ON". Las luces de colores se encenderán. El Bluetooth entra en el estado de emparejamiento y las luces roja y azul parpadean alternativamente.
2. Encienda el Bluetooth del teléfono móvil. Luego, busque y seleccione el nombre de emparejamiento de Bluetooth "iClever Transnova" en la lista de dispositivos para la conexión Bluetooth.

Encender / Apagar luces

Presione brevemente el botón "Encender / apagar luces" para encender / apagar las luces.

Cambiar la limitación de volumen

1. Mantenga presionados los botones "+" y "-" al mismo tiempo para cambiar el límite de volumen a 74dB y la transmisión de voz a "74dB".
2. Mantenga presionados los botones "+" y "-" al mismo tiempo para cambiar el límite de volumen a 85dB y la transmisión de voz a "85dB".
3. Mantenga presionados los botones "+" y "-" al mismo tiempo para cambiar el límite de volumen a 94dB y la transmisión de voz a "94dB".

Uso de los botones

Subir volumen	Presione brevemente el botón "+".
Bajar volumen	Presione brevemente el botón "-".

Siguiente pista	Mantenga presionado el botón "+" durante 2 segundos.
Pista anterior	Mantenga presionado el botón "-" durante 2 segundos.
Play / Pausa	Presione el botón MFB una vez.
Responder / finalizar una llamada	Presione el botón MFB una vez.
Rechazar una llamada	Mantenga pulsado el botón MFB durante unos segundos
Activar Siri	Presione el botón MFB dos veces.
Borrar la lista de emparejamiento	Mantenga presionado el botón "+" y el botón "-" simultáneamente durante 4 segundos en el estado de encendido para borrar la lista de emparejamiento. Luego, los auriculares entrarán automáticamente en estado de emparejamiento.

Avisos de voz

Encendido	Encendido
Apagado	Apagado
Emparejar	Emparejar
Emparejamiento exitoso	Conectado
Desconexión	Desconectado
Baja potencia	Batería baja

Especificaciones

Rango de frecuencia	2.4GHz~2.482GHz
Potencia máxima de transmisión	4dBm

Cómo cargar los auriculares

Conecte el cable tipo C al puerto de los auriculares y a una toma de corriente de 5 V (el adaptador de corriente no está incluido). La luz indicadora se iluminará en rojo para indicar que se está cargando. Cuando los auriculares estén completamente cargados, la luz indicadora cambiará de rojo a azul.

Método de funcionamiento de la cubierta de repuesto BTH16

1. Abra la tapa de la carcasa (como el diseño de la tapa del termo)

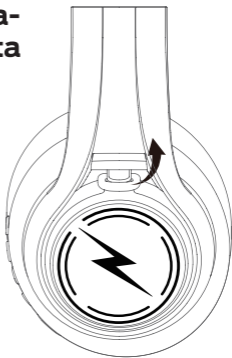

2. Retire la cubierta inferior

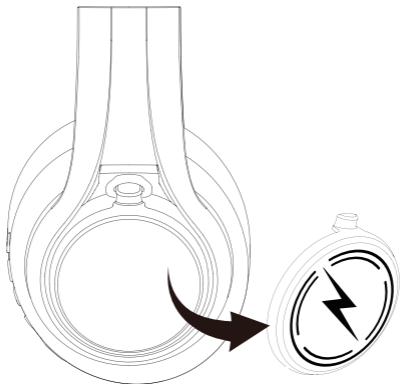

3. Reemplazar con otro par de fundas para orejas

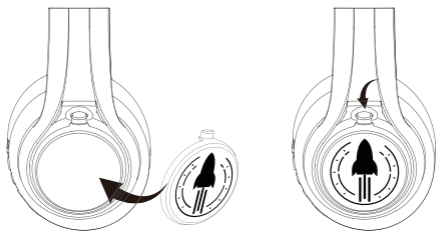

Contenuto della Confezione



1 x Cuffie Senza Fili
iClever BTH16



1 x Manuale Utente



1 x Cavo Audio da 3,5 mm



1 x Cavo USB di Tipo C

Diagramma del Prodotto

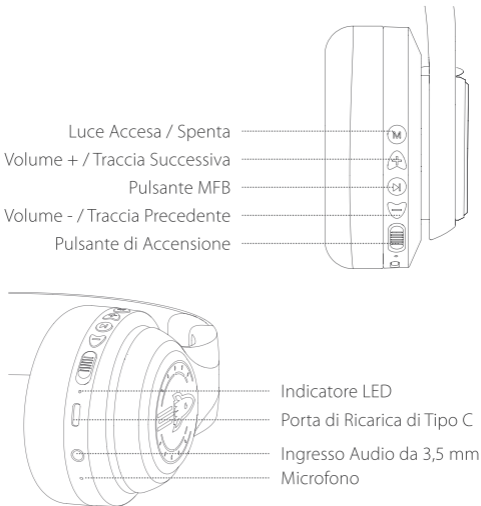

Acceso / Spento

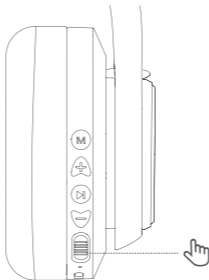

1. Accensione: Premere il pulsante su "ON". Quindi l'indicatore LED lampeggia in blu per 1 secondo e le luci colorate si illuminano.
2. Spegnimento: Premere il pulsante su "OFF" e le cuffie si spengono. L'indicatore LED lampeggia in blu per 1 secondo e poi si spegne.

Associazione Bluetooth

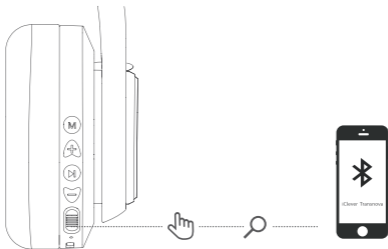

1. Quando è acceso, premere su "ON"; le luci colorate si accendono; il Bluetooth entra nello stato di associazione e le luci rossa e blu lampeggiano in maniera alternata.
2. Attivare il Bluetooth del telefono cellulare. Quindi trova e seleziona il nome di associazione Bluetooth "iClever Transnova" nell'elenco dei dispositivi per la connessione di associazione Bluetooth.

Luce accesa / spenta

Premere in maniera breve il pulsante "Luce On / Off" per accendere / spegnere la luce.

Cambio della Marcia con Limite di Volume

1. Tenere premuti in contemporanea i pulsanti "+" e "-" per impostare il limite del volume a 74dB e la trasmissione vocale a "74dB".
2. Tenere premuti in contemporanea i pulsanti "+" e "-" per impostare il limite del volume a 85 dB e la trasmissione vocale a "85 dB".
3. Tenere premuti in contemporanea i pulsanti "+" e "-" per impostare il limite del volume a 94dB e la trasmissione vocale a "94dB".

Operatività del Pulsante

Aumento del Volume	Premere brevemente il pulsante "+".
Abbassare il Volume	Premere brevemente il pulsante "-".

Prossima Traccia	Premere e tenere premuto il pulsante "+" per 2 secondi.
Traccia Precedente	Premere e tenere premuto il pulsante "-" per 2 secondi.
Avvio / Pausa	Premere una volta il pulsante MFB.
Rispondere/Chiudere la Chiamata	Premere una volta il pulsante MFB.
Rifiutare una Chiamata	Mantenere premuto il pulsante MFB per alcuni secondi.
Attivare Siri	Premere due volte il pulsante MFB.
Pulire la Lista di Associazione	Premere e tenere premuto il pulsante "+" e "-" in simultanea per 4 secondi nello stato di accensione per cancellare l'elenco di accoppiamento. Quindi le cuffie entreranno automaticamente nello stato di associazione.

Comandi Vocali

Accensione	Accensione
Spegnimento	Spegnimento
Associazione	Associazione
Associazione avvenuta con Successo	Connessione
Disconnessione	Disconnessione
Bassa Potenza	Bassa Potenza

Specifiche

limite di banda	2.4GHz~2.482GHz
Potenza massima di trasmissione	4dBm

Come Ricaricare le Cuffie

Collegare il cavo di tipo C alla porta di tipo C sulle cuffie e una presa di corrente da 5 V (l'alimentatore non è incluso). L'indicatore luminoso si illuminerà di rosso per indicare la carica. Quando le cuffie sono completamente cariche, l'indicatore luminoso cambierà da rosso a blu.

Metodo di Funzionamento per la Sostituzione della Copertura del BTH16

1. Apri il cappuccio sul guscio per orecchio (come il design del cappuccio sul thermos)

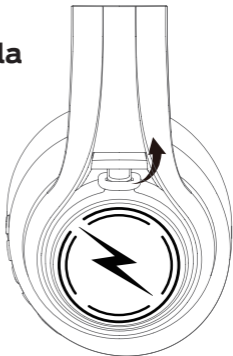

2. Rimuovere il coperchio inferiore

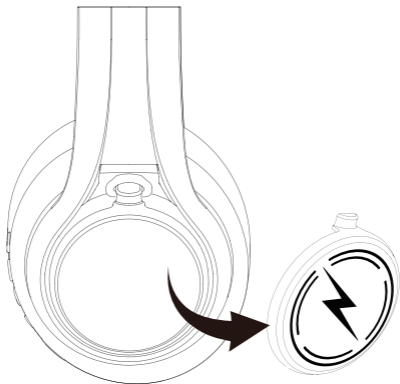

3. Sostituire con un altro paio di coperture dei gusci per orecchio

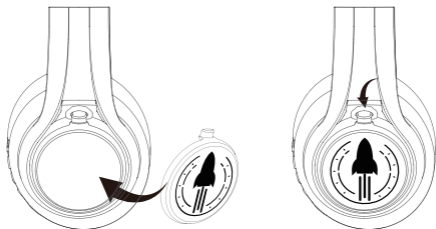

包装清单



1 x iClever BTH16 耳机

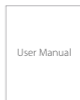

1 x 说明书



1 x 3.5mm 音频线



1 x Type-C 充电线

产品示意图

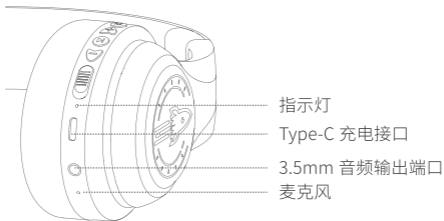
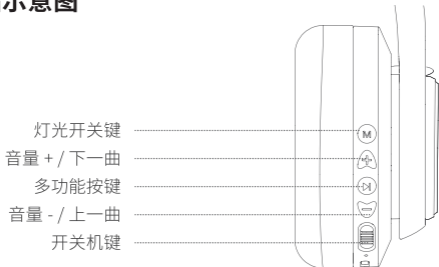

开 / 关

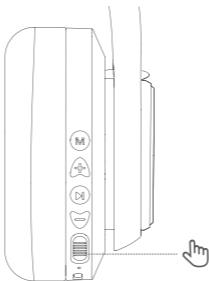

1. 开机：拨动开关键至“ON”方向，LED 指示灯为蓝色闪烁 1 秒，七彩灯亮。
2. 关机：拨动开关机按键到“OFF”，即耳机关机。LED 指示灯蓝色闪烁 1 秒后灯灭。

蓝牙配对

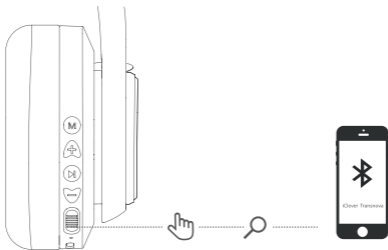

1. 在开机状态下，拨动开关键至 ON 方向，七彩灯亮，蓝牙进入配对状态，红蓝灯交替闪烁。
2. 打开手机蓝牙，在设备列表中，查找并选择“iClever Transnova”蓝牙配对名称进行蓝牙配对连接。

灯关开关键

短按灯关开关键，可以打开或者关闭灯光

音量限制开关

1. 同时按住“+” & “-” 按键，音量限制切换到 74dB, 语音播报为“74dB”
2. 同时按住“+” & “-” 按键，音量限制切换到 85dB, 语音播报为“85dB”
3. 同时按住“+” & “-” 按键，音量限制切换到 94dB, 语音播报为“94dB”

按键功能

音量加	短按 “+” 按键
音量减	短按 “-” 按键
下一曲	长按 “+” 按键 2 秒
上一曲	长按 “-” 按键 2 秒
播放 / 暂停	短按多功能按键
接听 / 挂断电话	短按多功能按键
拒接电话	长按多功能按键
激活 Siri	双击多功能按键
清除配对列表	同时长按音量 + 和音量 - 按键 4s，满足开机的所有状态下，清除后立刻自动进入配对状态。

语音提示

开机	Power on
关机	Power off
配对	Pairing
蓝牙连接成功	Connected
蓝牙断连	Disconnected
低电量提醒	Battery Low

规格参数

频段范围	2.4GHz~2.482GHz
最大传输功率	4dBm

耳机充电

将 Type-C 充电线一端接入 5V 电源适配器 (产品不含适配器)，另一端接入耳机。充电状态下红灯常亮，充满电后蓝灯常亮。

BTH16 替换面盖的操作方法

1. 打开耳壳上的盖子
(像是保温瓶上的瓶盖设计)

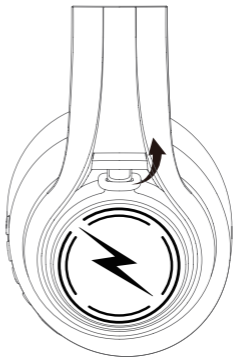

2. 取下面盖

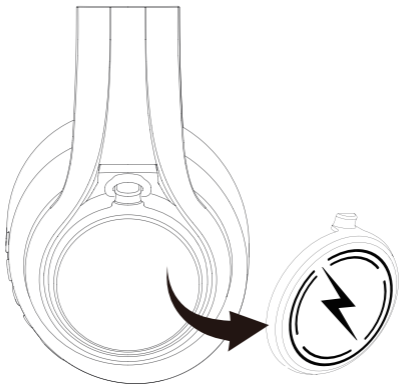

3. 换上另外一对耳壳面盖

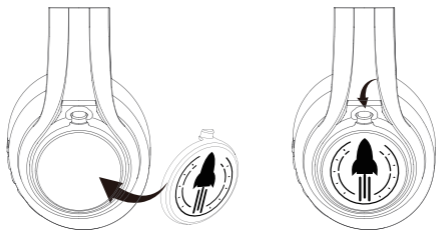

IC Caution

This device complies with Industry Canada licence-exempt RSS standard(s). Operation is subject to the following two conditions: (1) This device may not cause interference, and (2) This device must accept any interference, including interference that may cause undesired operation of the device.

Le présent appareil est conforme aux CNR d'Industrie Canada applicables aux appareils radio exempts de licence. L'exploitation est autorisée aux deux conditions suivantes: (1) l'appareil ne doit pas produire de brouillage, et (2) l'utilisateur de l'appareil doit accepter tout brouillage radioélectrique subi, même si le brouillage est susceptible d'en compromettre le fonctionnement.