

# LME49710

*LME49710 High Performance, High Fidelity Audio Operational Amplifier*



Literature Number: SNAS376B

# LME49710

## High Performance, High Fidelity Audio Operational Amplifier

### General Description

The LME49710 is part of the ultra-low distortion, low noise, high slew rate operational amplifier series optimized and fully specified for high performance, high fidelity applications. Combining advanced leading-edge process technology with state-of-the-art circuit design, the LME49710 audio operational amplifiers deliver superior audio signal amplification for outstanding audio performance. The LME49710 combines extremely low voltage noise density ( $2.5\text{nV}/\sqrt{\text{Hz}}$ ) with vanishingly low THD+N (0.00003%) to easily satisfy the most demanding audio applications. To ensure that the most challenging loads are driven without compromise, the LME49710 has a high slew rate of  $\pm 20\text{V}/\mu\text{s}$  and an output current capability of  $\pm 26\text{mA}$ . Further, dynamic range is maximized by an output stage that drives  $2\text{k}\Omega$  loads to within 1V of either power supply voltage and to within 1.4V when driving  $600\Omega$  loads.

The LME49710's outstanding CMRR (120dB), PSRR (120dB), and  $V_{OS}$  (0.05mV) give the amplifier excellent operational amplifier DC performance.

The LME49710 has a wide supply range of  $\pm 2.5\text{V}$  to  $\pm 17\text{V}$ . Over this supply range the LME49710's input circuitry maintains excellent common-mode and power supply rejection, as well as maintaining its low input bias current. The LME49710 is unity gain stable. The Audio Operational Amplifier achieves outstanding AC performance while driving complex loads with values as high as  $100\text{pF}$ .

The LME49710 is available in 8-lead narrow body SOIC, 8-lead plastic DIP, and 8-lead metal can TO-99. Demonstration boards are available for each package.

### Key Specifications

■ Power Supply Voltage Range	$\pm 2.5\text{V}$ to $\pm 17\text{V}$
■ THD+N ( $A_V = 1$ , $V_{OUT} = 3V_{RMS}$ , $f_{IN} = 1\text{kHz}$ )	
$R_L = 2\text{k}\Omega$	0.00003% (typ)
$R_L = 600\Omega$	0.00003% (typ)
■ Input Noise Density	$2.5\text{nV}/\sqrt{\text{Hz}}$ (typ)
■ Slew Rate	$\pm 20\text{V}/\mu\text{s}$ (typ)
■ Gain Bandwidth Product	55MHz (typ)
■ Open Loop Gain ( $R_L = 600\Omega$ )	140dB (typ)
■ Input Bias Current	7nA (typ)
■ Input Offset Voltage	0.05mV (typ)
■ DC Gain Linearity Error	0.000009%

### Features

- Easily drives  $600\Omega$  loads
- Optimized for superior audio signal fidelity
- Output short circuit protection
- PSRR and CMRR exceed 120dB (typ)
- SOIC, DIP, TO-99 metal can packages

### Applications

- Ultra high quality audio amplification
- High fidelity preamplifiers
- High fidelity multimedia
- State of the art phono pre amps
- High performance professional audio
- High fidelity equalization and crossover networks
- High performance line drivers
- High performance line receivers
- High fidelity active filters

## Typical Application

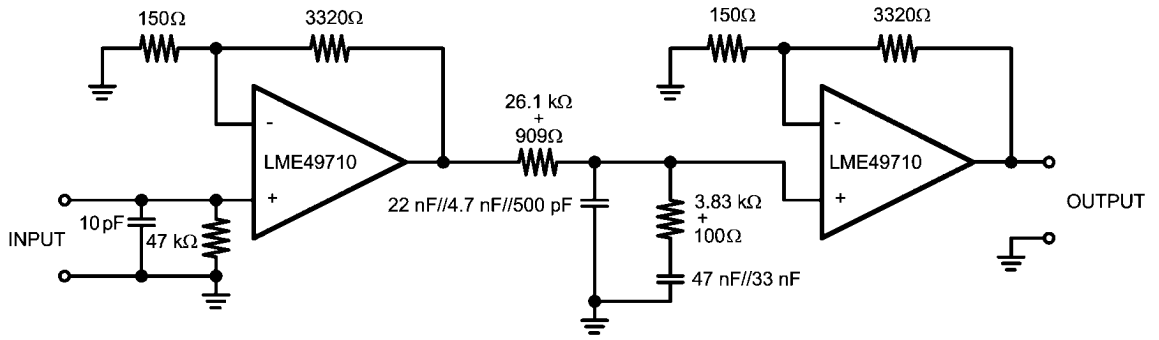

Note: 1% metal film resistors, 5% polypropylene capacitors

20210406

FIGURE 1. Passively Equalized RIAA Phono Preamp

# Connection Diagrams

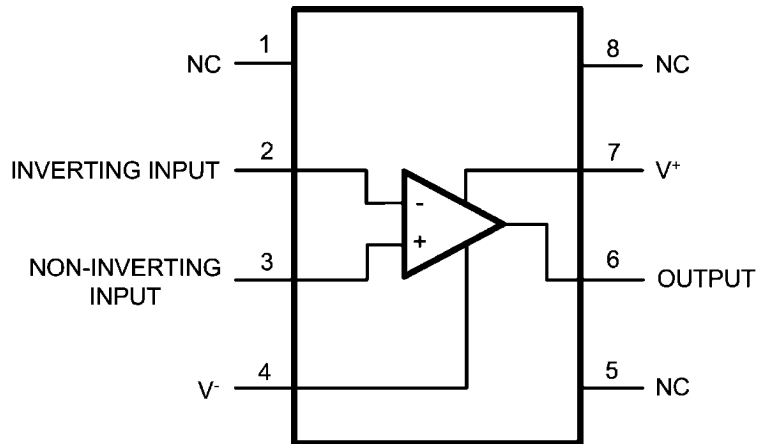

20210402

Order Number LME49710MA  
 See NS Package Number — M08A  
 Order Number LME49710NA  
 See NS Package Number — N08E

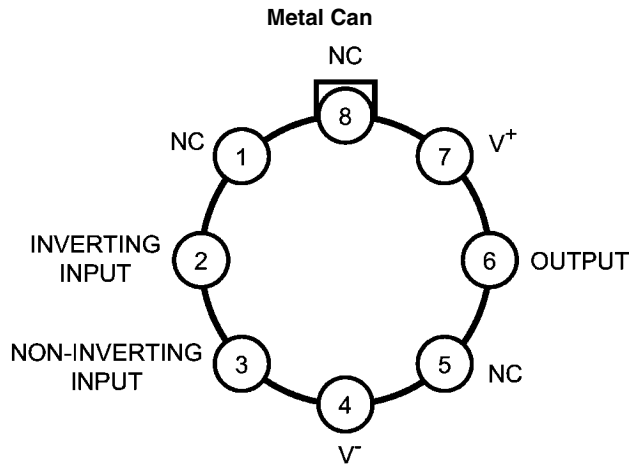

20210405

Order Number LME49710HA  
 See NS Package Number — H08C

**Absolute Maximum Ratings** (Notes 1, 2)

If Military/Aerospace specified devices are required, please contact the National Semiconductor Sales Office/ Distributors for availability and specifications.

Power Supply Voltage ( $V_S = V^+ - V^-$ )	36V
Storage Temperature	-65°C to 150°C
Input Voltage	(V-) - 0.7V to (V+) + 0.7V
Output Short Circuit (Note 3)	Continuous
Power Dissipation	Internally Limited
ESD Susceptibility (Note 4)	2000V

ESD Susceptibility (Note 5)	200V
Junction Temperature	150°C
Thermal Resistance	
$\theta_{JA}$ (SO)	145°C/W
$\theta_{JA}$ (NA)	102°C/W
$\theta_{JA}$ (HA)	150°C/W
$\theta_{JC}$ (HA)	35°C/W
Temperature Range	
$T_{MIN} \leq T_A \leq T_{MAX}$	-40°C $\leq$ $T_A$ $\leq$ 85°C
Supply Voltage Range	$\pm 2.5V \leq V_S \leq \pm 17V$

**Electrical Characteristics** (Notes 1, 2)

The following specifications apply for  $V_S = \pm 15V$ ,  $R_L = 2k\Omega$ ,  $f_{IN} = 1kHz$ , and  $T_A = 25^\circ C$ , unless otherwise specified.

Symbol	Parameter	Conditions	LME49710		Units (Limits)
			Typical	Limit	
			(Note 6)	(Notes 7, 8)	
THD+N	Total Harmonic Distortion + Noise	$A_V = 1$ , $V_{OUT} = 3V_{RMS}$ $R_L = 2k\Omega$ $R_L = 600\Omega$	0.00003	0.00009	% (max)
			0.00003		% (max)
IMD	Intermodulation Distortion	$A_V = 1$ , $V_{OUT} = 3V_{RMS}$ Two-tone, 60Hz & 7kHz 4:1	0.00005		% (max)
GBWP	Gain Bandwidth Product		55	45	MHz (min)
SR	Slew Rate		$\pm 20$	$\pm 15$	V/ $\mu s$ (min)
FPBW	Full Power Bandwidth	$V_{OUT} = 1V_{P-P}$ , -3dB referenced to output magnitude at $f = 1kHz$	10		MHz
$t_s$	Settling time	$A_V = 1$ , 10V step, $C_L = 100pF$ 0.1% error range	1.2		$\mu s$
$e_n$	Equivalent Input Noise Voltage	$f_{BW} = 20Hz$ to 20kHz	0.34	0.65	$\mu V_{RMS}$
	Equivalent Input Noise Density	$f = 1kHz$ $f = 10Hz$	2.5 6.4	4.7	$nV/\sqrt{Hz}$ $nV/\sqrt{Hz}$
$i_n$	Current Noise Density	$f = 1kHz$ $f = 10Hz$	1.6		$pA/\sqrt{Hz}$
			3.1		$pA/\sqrt{Hz}$
$V_{OS}$	Offset Voltage		$\pm 0.05$	$\pm 0.7$	mV (max)
$\Delta V_{OS}/\Delta Temp$	Average Input Offset Voltage Drift vs Temperature	$40^\circ C \leq T_A \leq 85^\circ C$	0.2		$\mu V/^\circ C$
PSRR	Average Input Offset Voltage Shift vs Power Supply Voltage	$\Delta V_S = 20V$ (Note 9)	125	110	dB (min)
$I_B$	Input Bias Current	$V_{CM} = 0V$	7	72	nA (max)
$\Delta I_{OS}/\Delta Temp$	Input Bias Current Drift vs Temperature	$-40^\circ C \leq T_A \leq 85^\circ C$	0.1		nA/ $^\circ C$
$I_{OS}$	Input Offset Current	$V_{CM} = 0V$	5	65	nA (max)
$V_{IN-CM}$	Common-Mode Input Voltage Range		+14.1	(V+) - 2.0	V (min)
			-13.9	(V-) + 2.0	V (min)
CMRR	Common-Mode Rejection	$-10V < V_{CM} < 10V$	120	110	dB (min)
$Z_{IN}$	Differential Input Impedance		30		k $\Omega$
	Common Mode Input Impedance	$-10V < V_{CM} < 10V$	1000		M $\Omega$
$A_{VOL}$	Open Loop Voltage Gain	$-10V < V_{OUT} < 10V$ , $R_L = 600\Omega$	140		dB
		$-10V < V_{OUT} < 10V$ , $R_L = 2k\Omega$	140	125	dB
		$-10V < V_{OUT} < 10V$ , $R_L = 10k\Omega$	140		dB

Symbol	Parameter	Conditions	LME49710		Units (Limits)
			Typical	Limit	
			(Note 6)	(Notes 7, 8)	
$V_{OUTMAX}$	Maximum Output Voltage Swing	$R_L = 600\Omega$	$\pm 13.6$	$\pm 12.5$	V
		$R_L = 2k\Omega$	$\pm 14.0$		V
		$R_L = 10k\Omega$	$\pm 14.1$		V
$I_{OUT}$	Output Current	$R_L = 600\Omega, V_S = \pm 17V$	$\pm 26$	$\pm 23$	mA (min)
$I_{OUT-CC}$	Short Circuit Current		+53 -42		mA mA
$R_{OUT}$	Output Impedance	$f_{IN} = 10kHz$ Closed-Loop	0.01		$\Omega$
		Open-Loop	13		$\Omega$
$C_{LOAD}$	Capacitive Load Drive Overshoot	100pF	16		%
$I_S$	Quiescent Current	$I_{OUT} = 0mA$	4.8	5.5	mA (max)

**Note 1:** Absolute Maximum Ratings indicate limits beyond which damage to the device may occur.

**Note 2:** Operating Ratings indicate conditions for which the device is functional, but do not guarantee specific performance limits. For guaranteed specifications and test conditions, see the Electrical Characteristics. The guaranteed specifications apply only for the test conditions listed. Some performance characteristics may degrade when the device is not operated under the listed test conditions.

**Note 3:** Amplifier output connected to GND, any number of amplifiers within a package.

**Note 4:** Human body model, 100pF discharged through a 1.5k $\Omega$  resistor.

**Note 5:** Machine Model ESD test is covered by specification EIAJ IC-121-1981. A 200pF cap is charged to the specified voltage and then discharged directly into the IC with no external series resistor (resistance of discharge path must be under 50 $\Omega$ ).

**Note 6:** Typical specifications are specified at +25°C and represent the most likely parametric norm.

**Note 7:** Tested limits are guaranteed to National's AOQL (Average Outgoing Quality Level).

**Note 8:** Datasheet min/max specification limits are guaranteed by design, test, or statistical analysis.

**Note 9:** PSRR is measured as follows:  $V_{OS}$  is measured at two supply voltages,  $\pm 5V$  and  $\pm 15V$ .  $PSRR = |20\log(\Delta V_{OS}/\Delta V_S)|$ .

# Typical Performance Characteristics

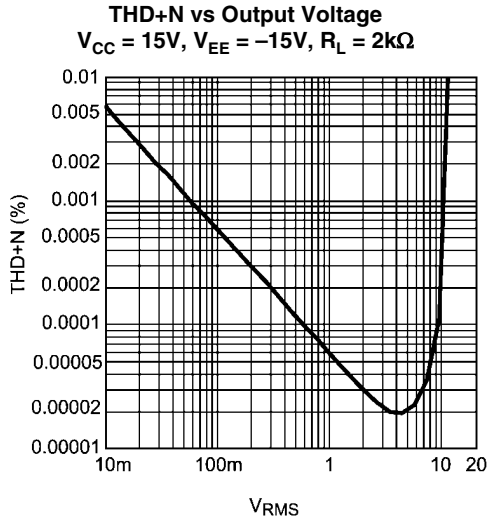

20210476

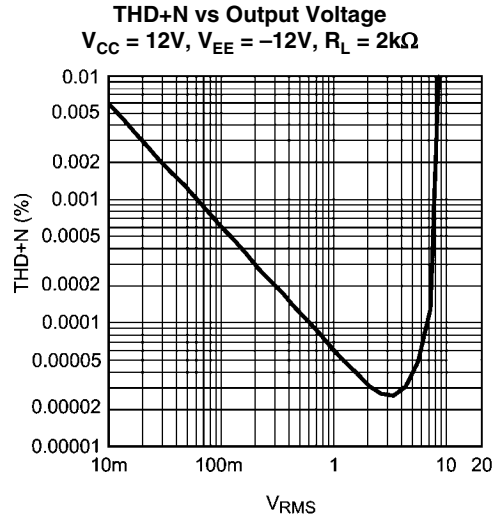

20210473

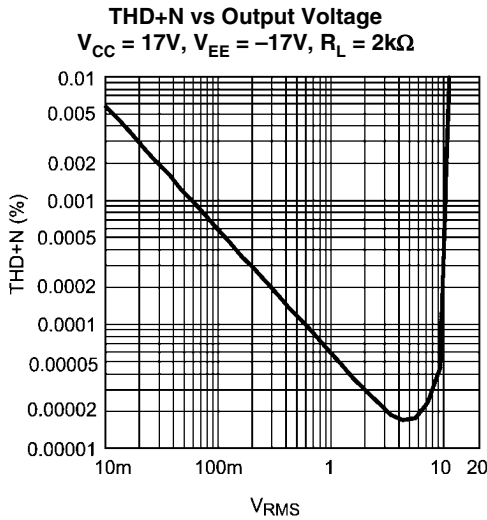

20210479

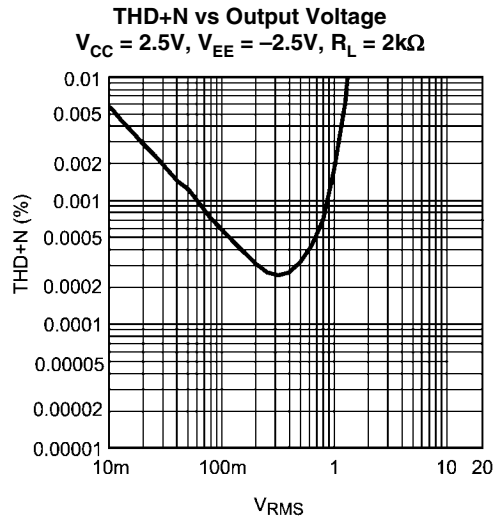

20210470

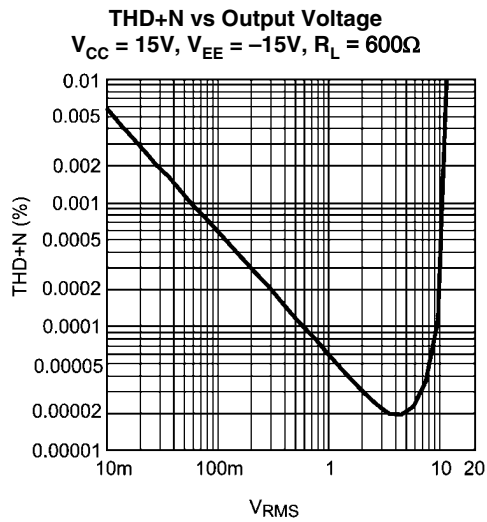

20210478

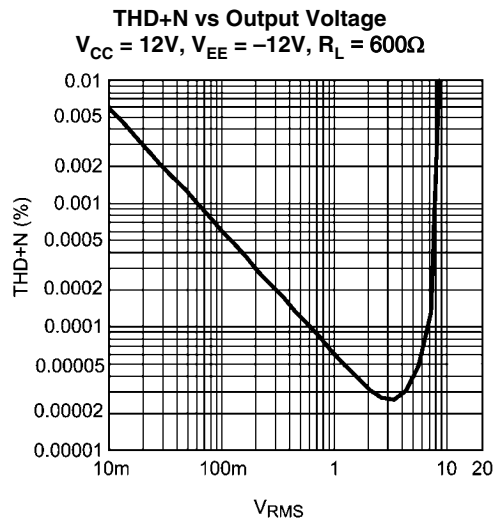

20210475

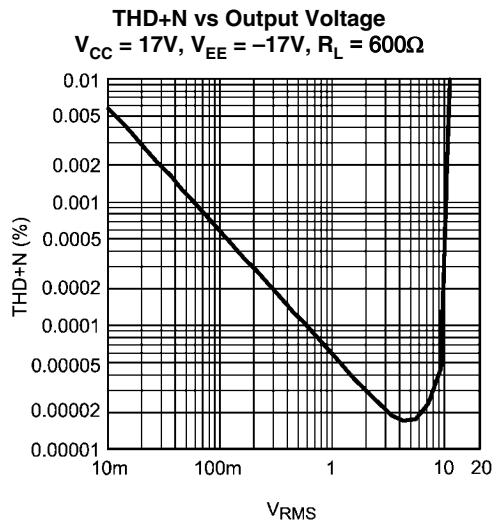

20210481

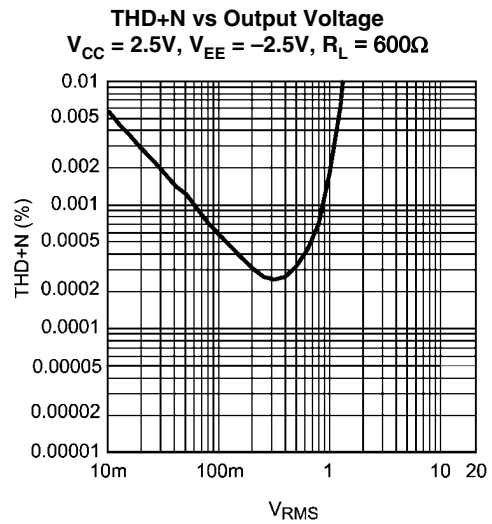

20210472

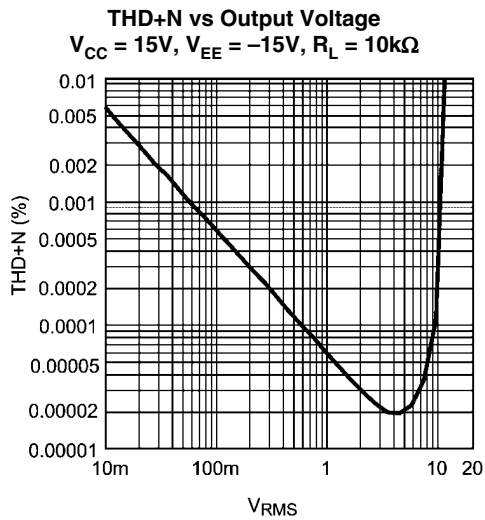

20210477

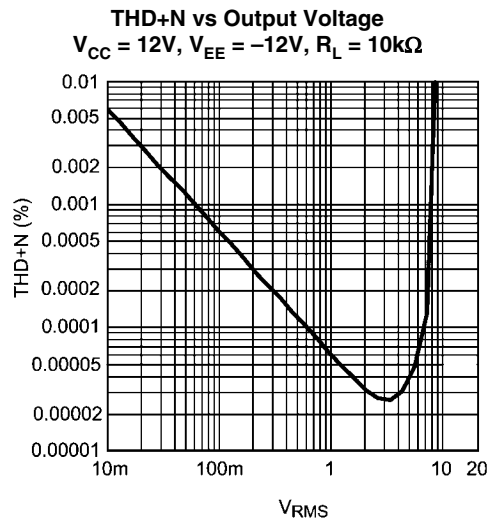

20210474

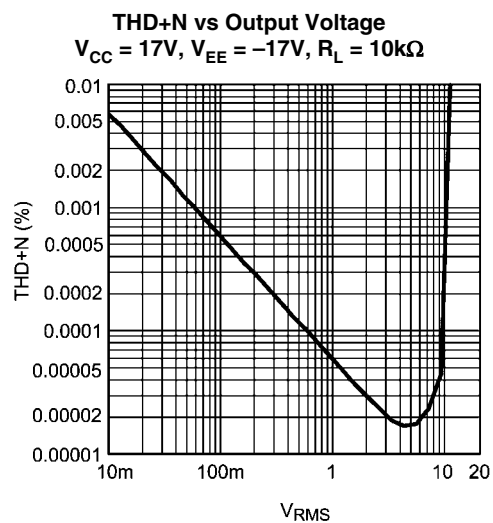

20210480

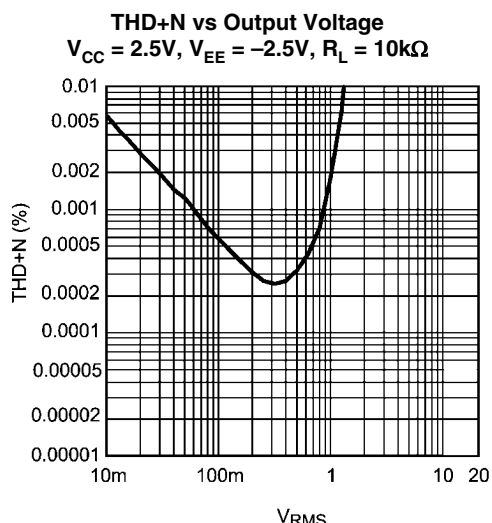

20210471



**THD+N vs Frequency**  
 $V_{CC} = 15V, V_{EE} = -15V,$   
 $R_L = 2k\Omega, V_{OUT} = 3V_{RMS}$

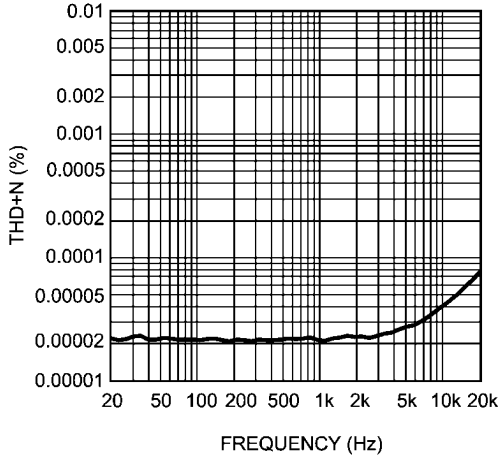

20210464

**THD+N vs Frequency**  
 $V_{CC} = 17V, V_{EE} = -17V,$   
 $R_L = 2k\Omega, V_{OUT} = 3V_{RMS}$

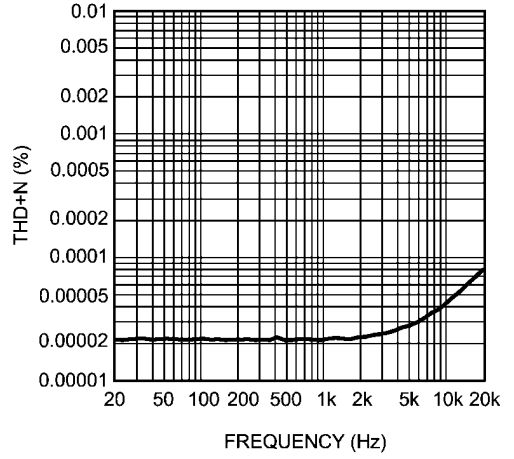

20210467

**THD+N vs Frequency**  
 $V_{CC} = 15V, V_{EE} = -15V,$   
 $R_L = 600\Omega, V_{OUT} = 3V_{RMS}$

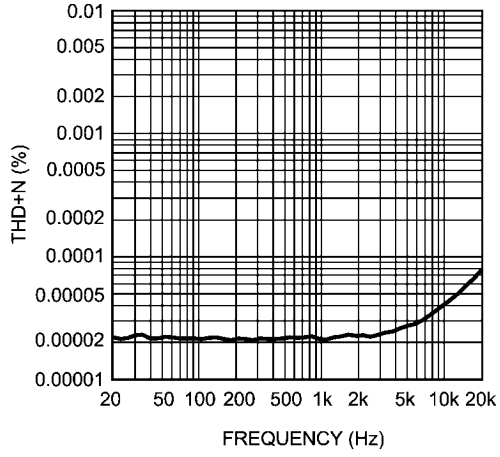

20210466

**THD+N vs Frequency**  
 $V_{CC} = 17V, V_{EE} = -17V,$   
 $R_L = 600\Omega, V_{OUT} = 3V_{RMS}$

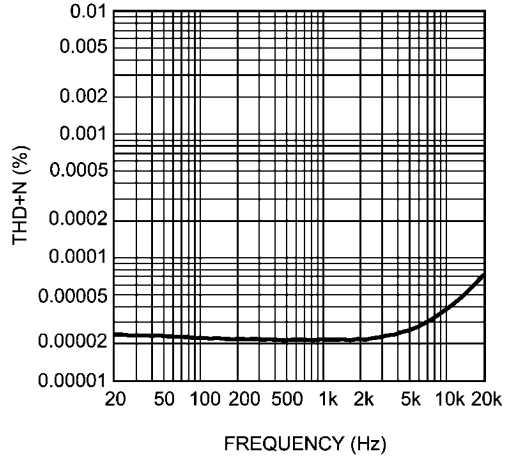

20210469

**THD+N vs Frequency**  
 $V_{CC} = 15V, V_{EE} = -15V,$   
 $R_L = 10k\Omega, V_{OUT} = 3V_{RMS}$

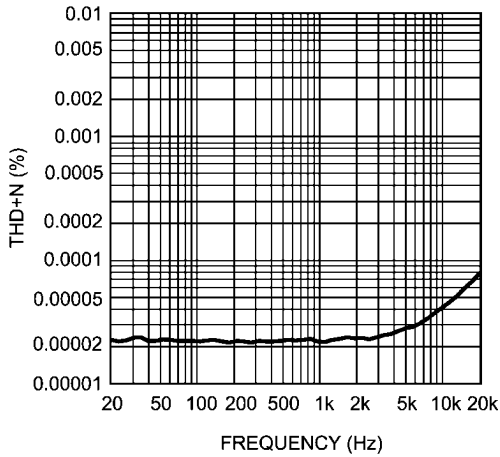

20210465

**THD+N vs Frequency**  
 $V_{CC} = 17V, V_{EE} = -17V,$   
 $R_L = 10k\Omega, V_{OUT} = 3V_{RMS}$

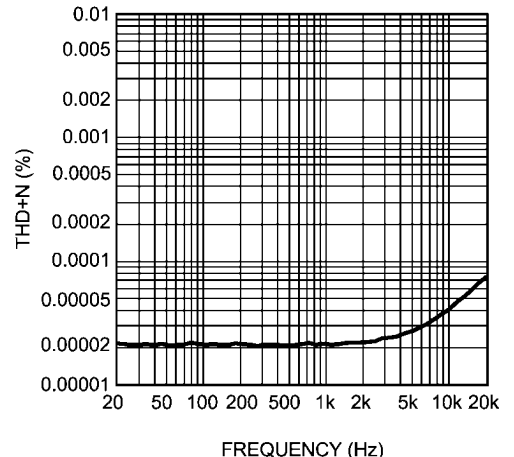

20210468

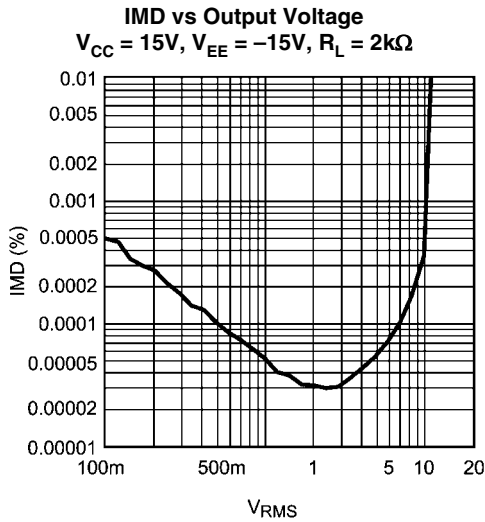

20210414

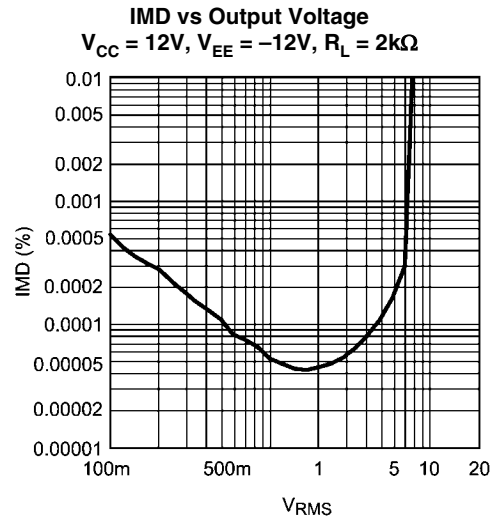

20210411

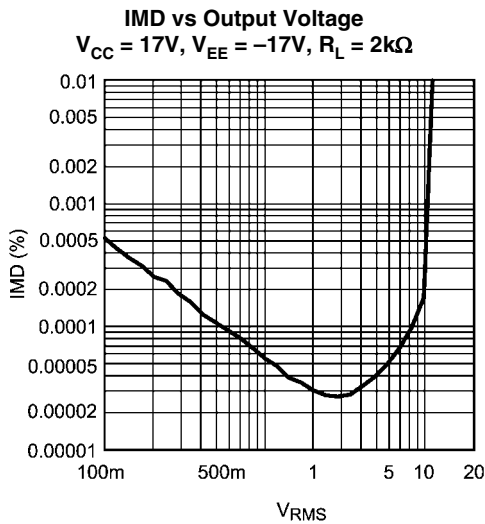

20210417

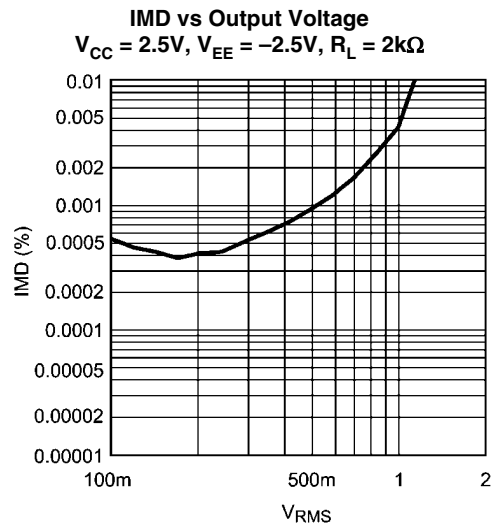

20210408

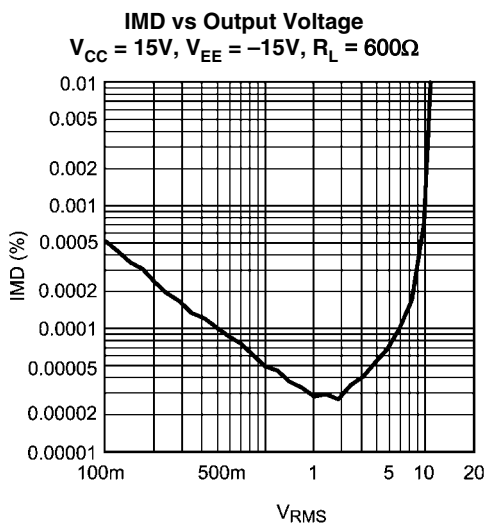

20210416

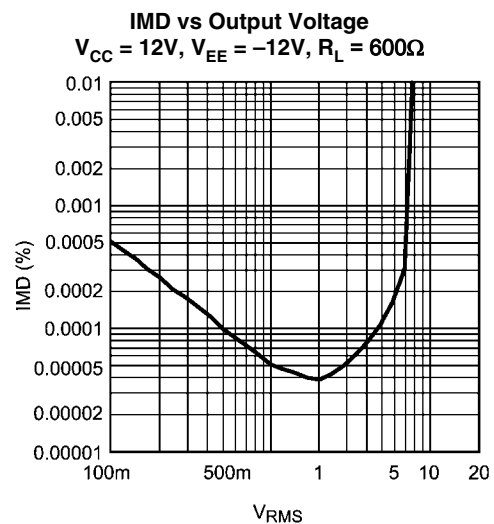

20210413

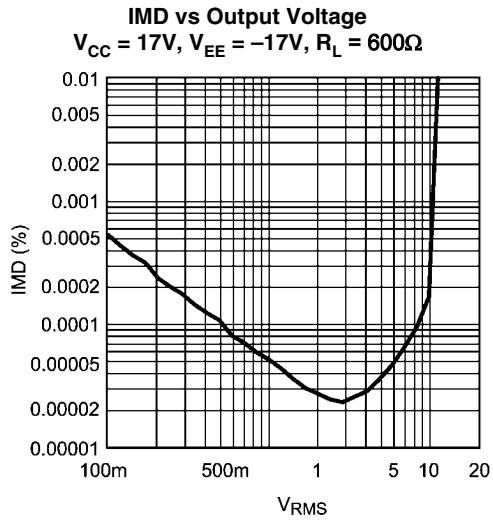

20210419

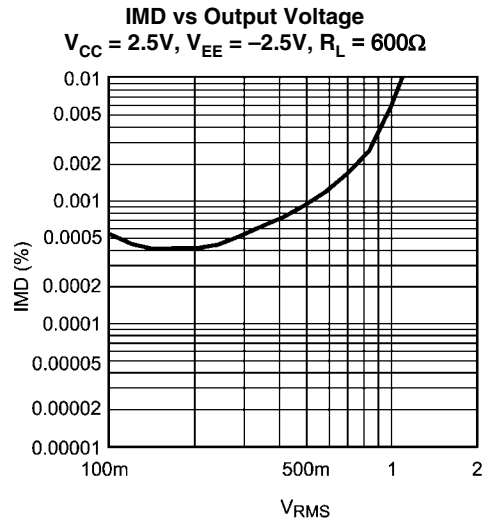

20210410

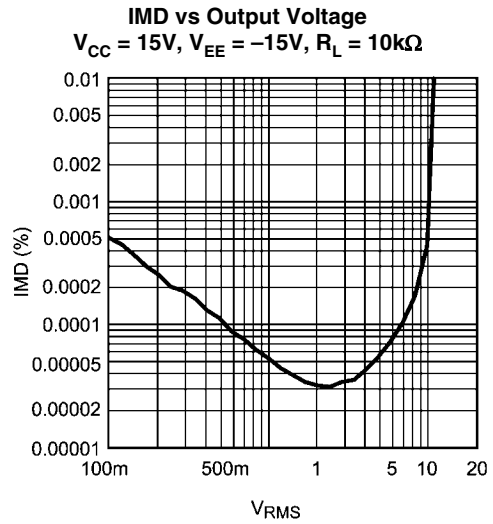

20210415

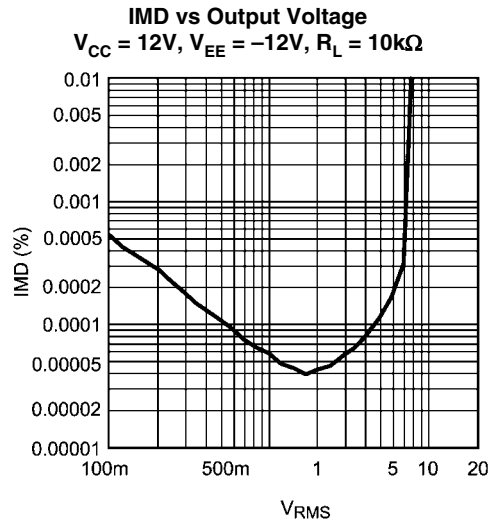

20210412

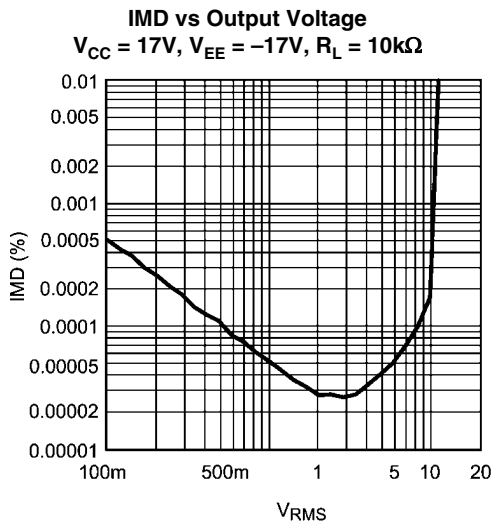

20210418

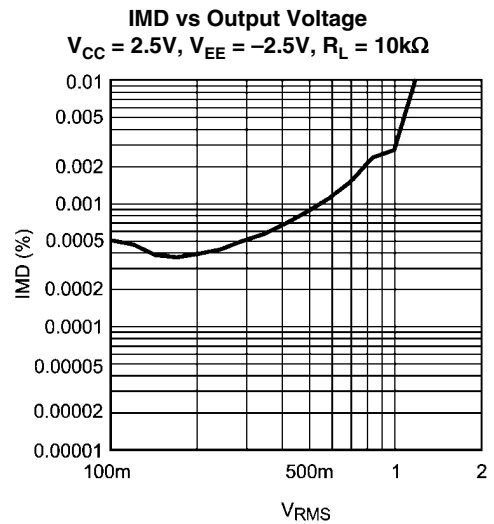

20210409

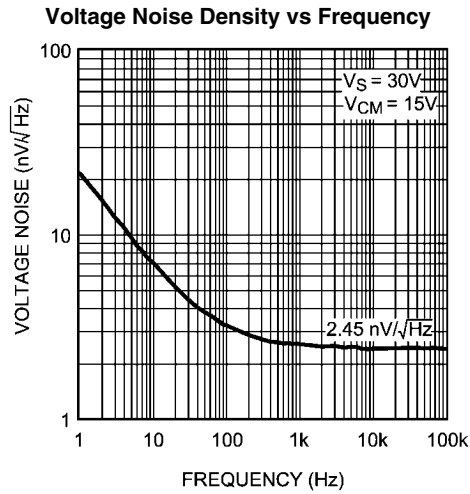

20210490

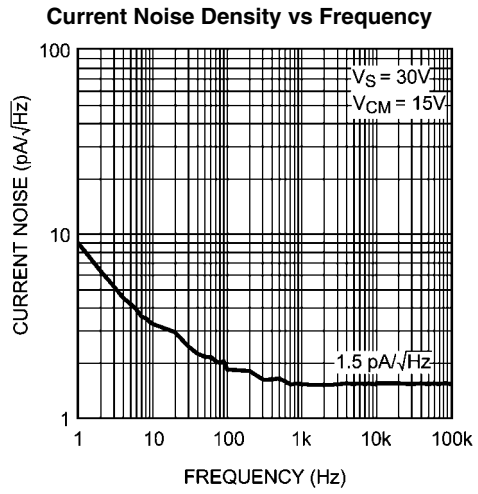

20210489

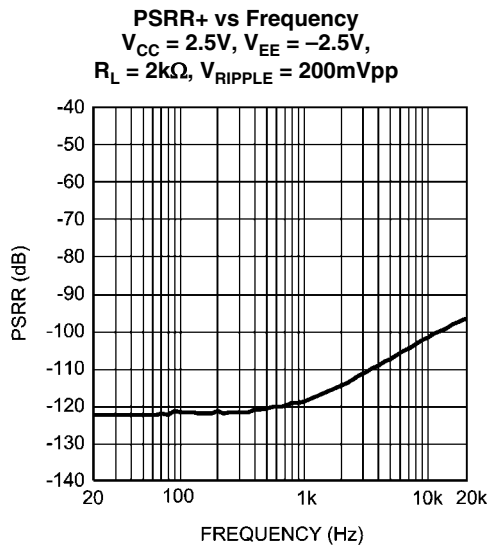

20210491

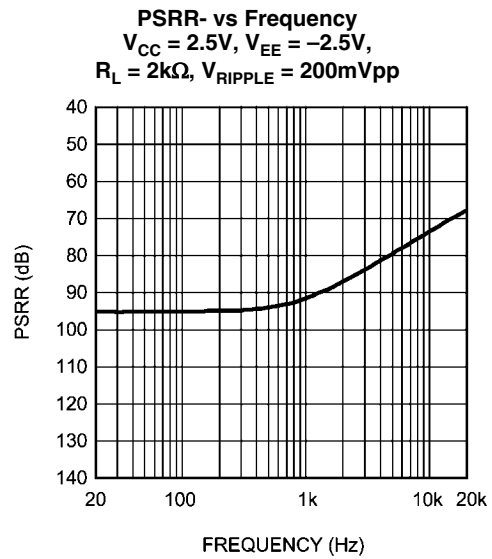

20210420

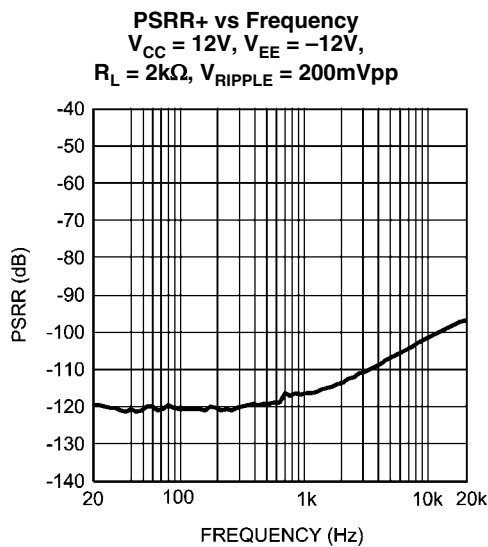

20210494

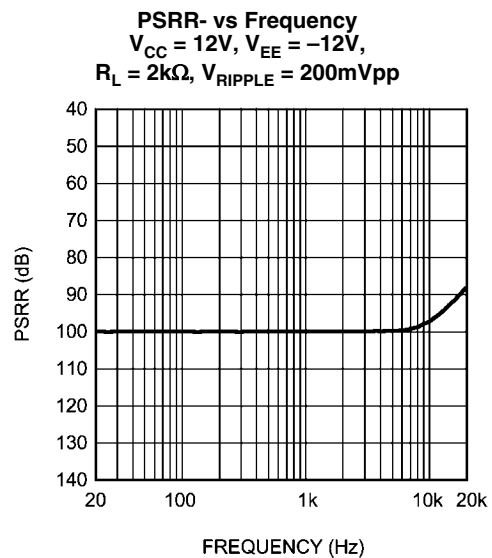

20210455

**PSRR+ vs Frequency**  
 $V_{CC} = 15V, V_{EE} = -15V,$   
 $R_L = 2k\Omega, V_{RIPPLE} = 200mVpp$

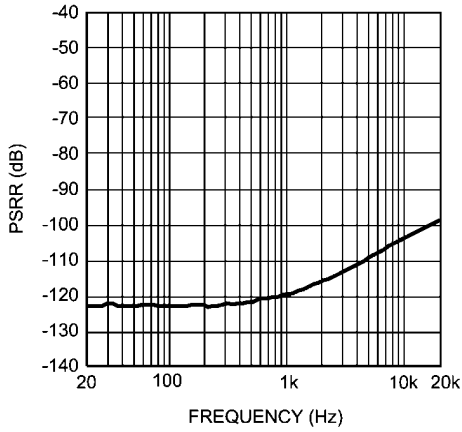

20210497

**PSRR- vs Frequency**  
 $V_{CC} = 15V, V_{EE} = -15V,$   
 $R_L = 2k\Omega, V_{RIPPLE} = 200mVpp$

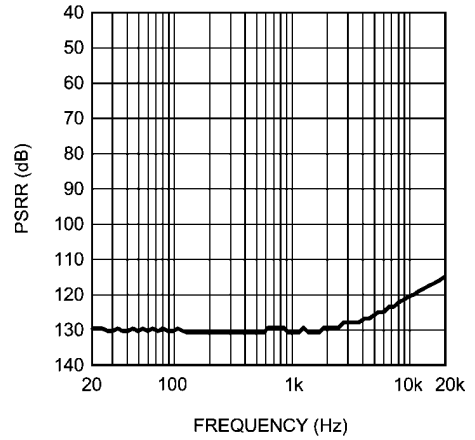

20210425

**PSRR+ vs Frequency**  
 $V_{CC} = 17V, V_{EE} = -17V,$   
 $R_L = 2k\Omega, V_{RIPPLE} = 200mVpp$

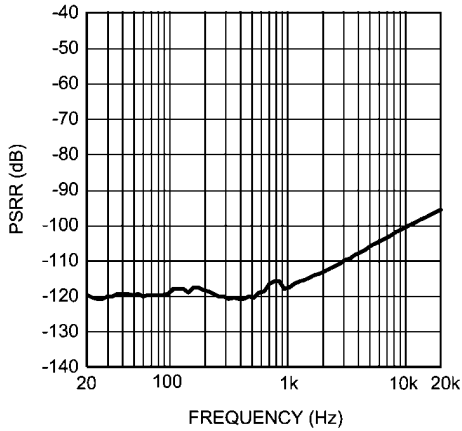

202104a0

**PSRR- vs Frequency**  
 $V_{CC} = 17V, V_{EE} = -17V,$   
 $R_L = 2k\Omega, V_{RIPPLE} = 200mVpp$

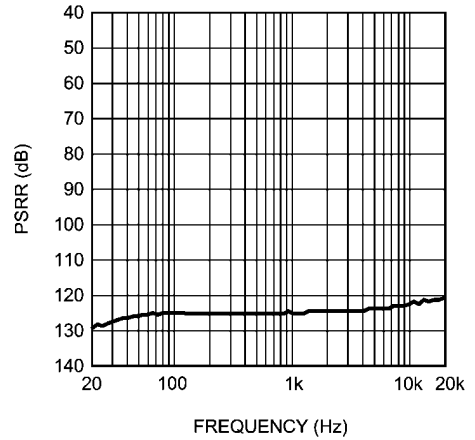

20210438

**PSRR+ vs Frequency**  
 $V_{CC} = 2.5V, V_{EE} = -2.5V,$   
 $R_L = 600\Omega, V_{RIPPLE} = 200mVpp$

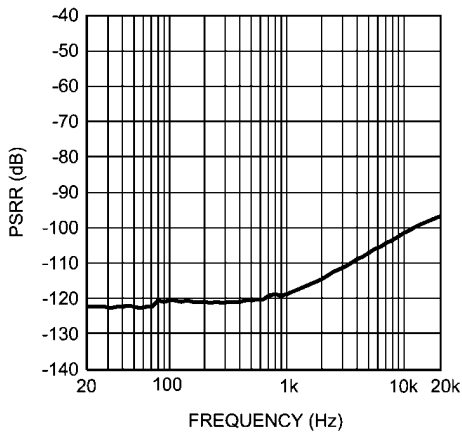

20210493

**PSRR- vs Frequency**  
 $V_{CC} = 2.5V, V_{EE} = -2.5V,$   
 $R_L = 600\Omega, V_{RIPPLE} = 200mVpp$

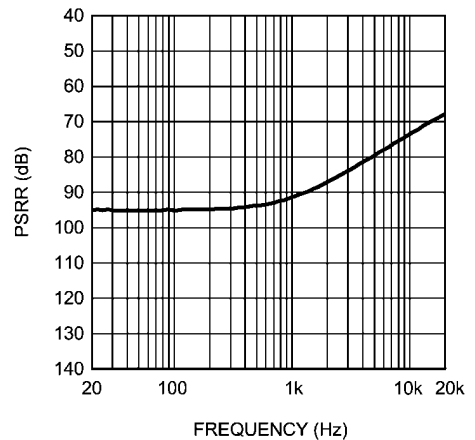

20210421

**PSRR+ vs Frequency**  
 $V_{CC} = 12V, V_{EE} = -12V,$   
 $R_L = 600\Omega, V_{RIPPLE} = 200mV_{pp}$

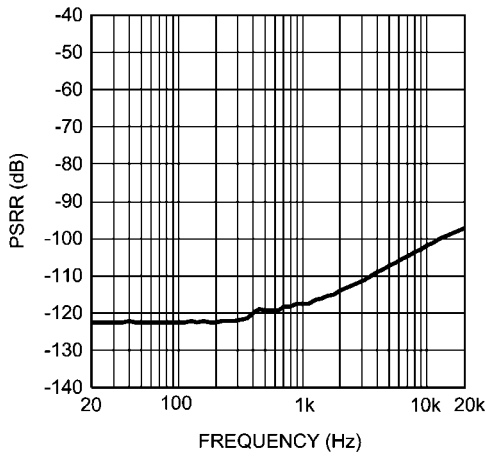

20210496

**PSRR- vs Frequency**  
 $V_{CC} = 12V, V_{EE} = -12V,$   
 $R_L = 600\Omega, V_{RIPPLE} = 200mV_{pp}$

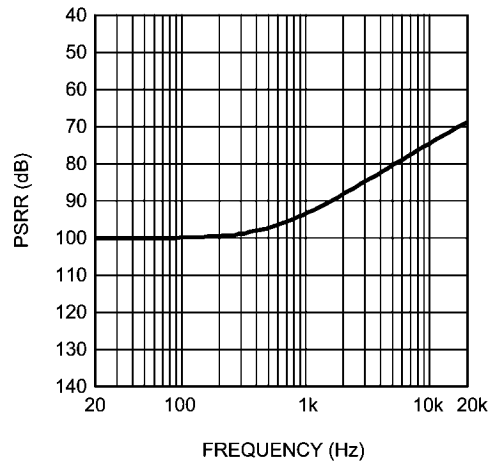

20210424

**PSRR+ vs Frequency**  
 $V_{CC} = 15V, V_{EE} = -15V,$   
 $R_L = 600\Omega, V_{RIPPLE} = 200mV_{pp}$

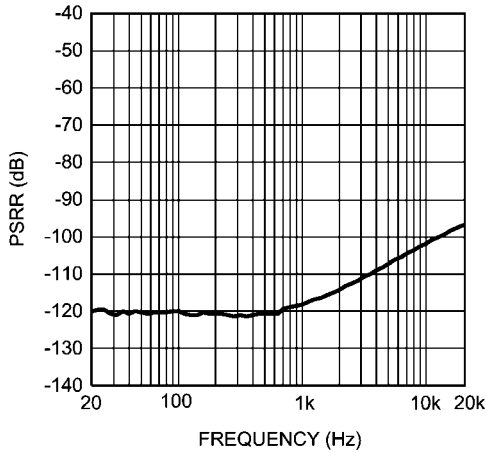

20210499

**PSRR- vs Frequency**  
 $V_{CC} = 15V, V_{EE} = -15V,$   
 $R_L = 600\Omega, V_{RIPPLE} = 200mV_{pp}$

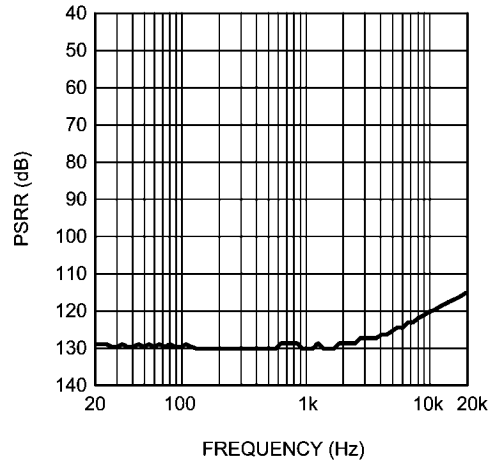

20210451

**PSRR+ vs Frequency**  
 $V_{CC} = 17V, V_{EE} = -17V,$   
 $R_L = 600\Omega, V_{RIPPLE} = 200mV_{pp}$

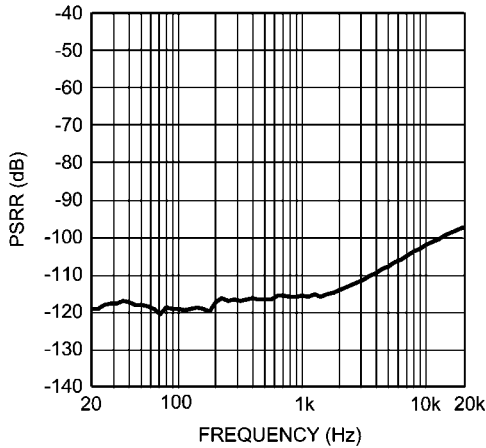

202104a2

**PSRR- vs Frequency**  
 $V_{CC} = 17V, V_{EE} = -17V,$   
 $R_L = 600\Omega, V_{RIPPLE} = 200mV_{pp}$

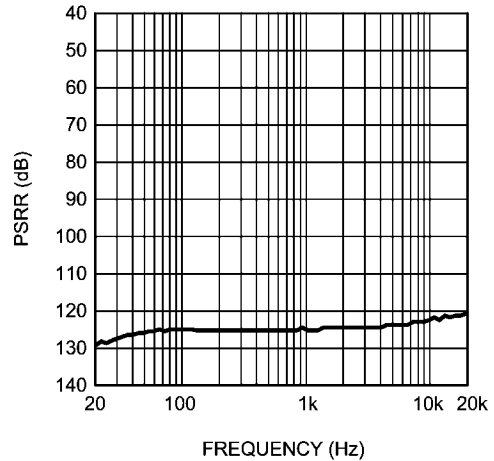

20210444

**PSRR+ vs Frequency**  
 $V_{CC} = 2.5V, V_{EE} = -2.5V,$   
 $R_L = 10k\Omega, V_{RIPPLE} = 200mV_{pp}$

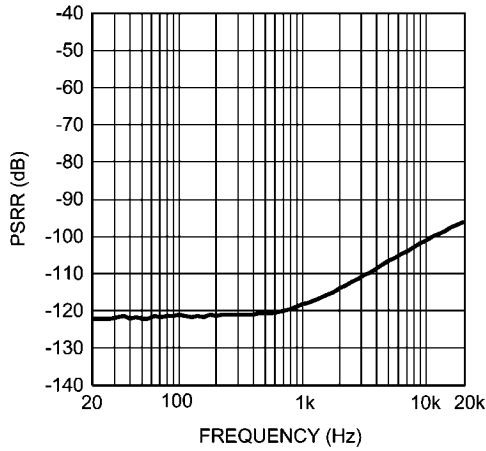

20210492

**PSRR- vs Frequency**  
 $V_{CC} = 2.5V, V_{EE} = -2.5V,$   
 $R_L = 10k\Omega, V_{RIPPLE} = 200mV_{pp}$

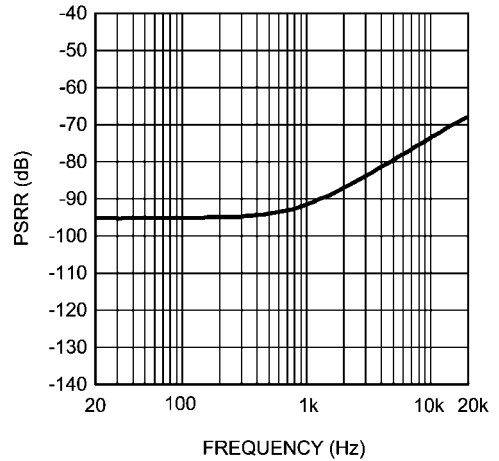

20210488

**PSRR+ vs Frequency**  
 $V_{CC} = 12V, V_{EE} = -12V,$   
 $R_L = 10k\Omega, V_{RIPPLE} = 200mV_{pp}$

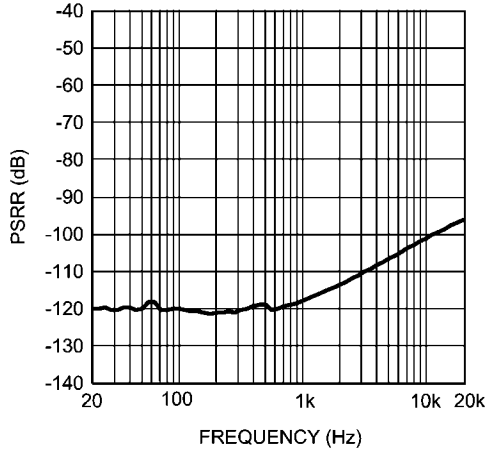

20210495

**PSRR- vs Frequency**  
 $V_{CC} = 12V, V_{EE} = -12V,$   
 $R_L = 10k\Omega, V_{RIPPLE} = 200mV_{pp}$

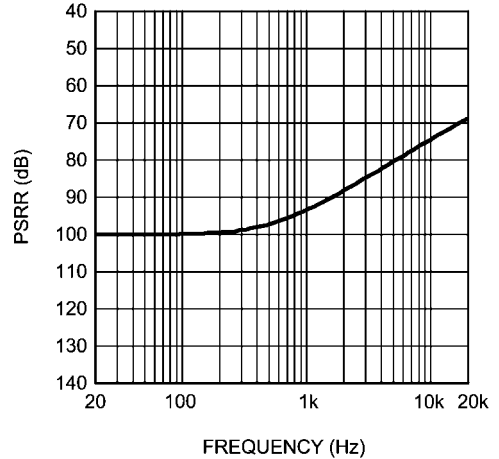

20210423

**PSRR+ vs Frequency**  
 $V_{CC} = 15V, V_{EE} = -15V,$   
 $R_L = 10k\Omega, V_{RIPPLE} = 200mV_{pp}$

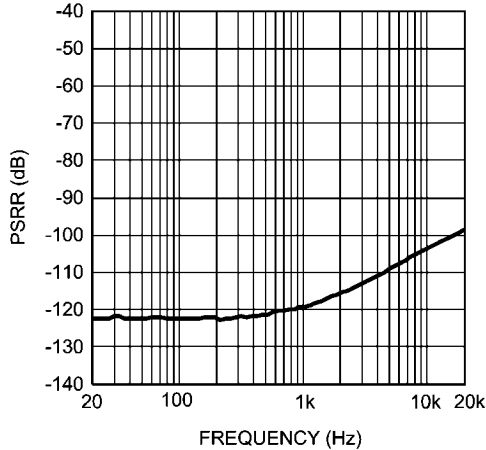

20210498

**PSRR- vs Frequency**  
 $V_{CC} = 15V, V_{EE} = -15V,$   
 $R_L = 10k\Omega, V_{RIPPLE} = 200mV_{pp}$

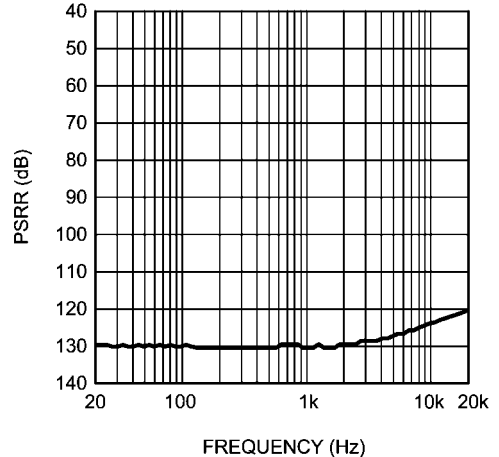

20210426

**PSRR+ vs Frequency**  
 $V_{CC} = 17V, V_{EE} = -17V,$   
 $R_L = 10k\Omega, V_{RIPPLE} = 200mV_{pp}$

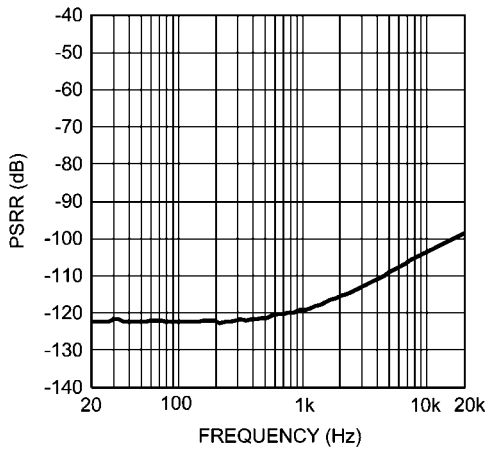

202104a1

**PSRR- vs Frequency**  
 $V_{CC} = 17V, V_{EE} = -17V,$   
 $R_L = 10k\Omega, V_{RIPPLE} = 200mV_{pp}$

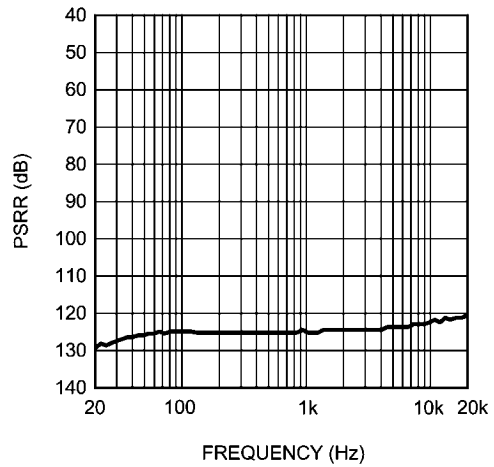

20210439

**CMRR vs Frequency**  
 $V_{CC} = 15V, V_{EE} = -15V,$   
 $R_L = 2k\Omega$

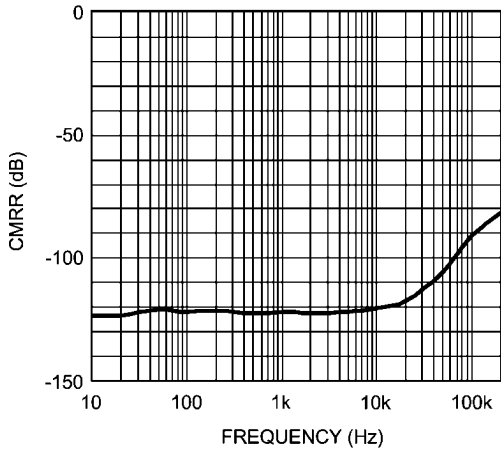

202104b1

**CMRR vs Frequency**  
 $V_{CC} = 12V, V_{EE} = -12V,$   
 $R_L = 2k\Omega$

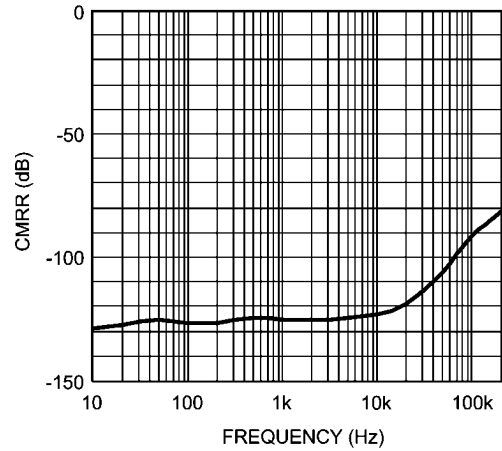

202104a8

**CMRR vs Frequency**  
 $V_{CC} = 17V, V_{EE} = -17V,$   
 $R_L = 2k\Omega$

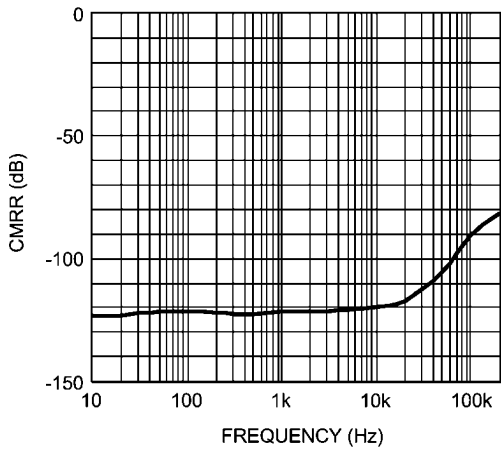

202104b4

**CMRR vs Frequency**  
 $V_{CC} = 2.5V, V_{EE} = -2.5V,$   
 $R_L = 2k\Omega$

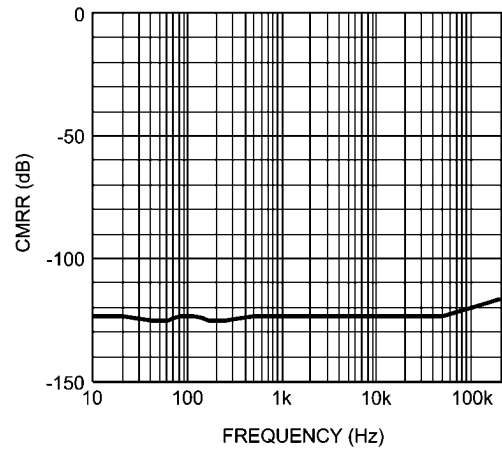

202104a5



**CMRR vs Frequency**  
 $V_{CC} = 15V, V_{EE} = -15V,$   
 $R_L = 600\Omega$

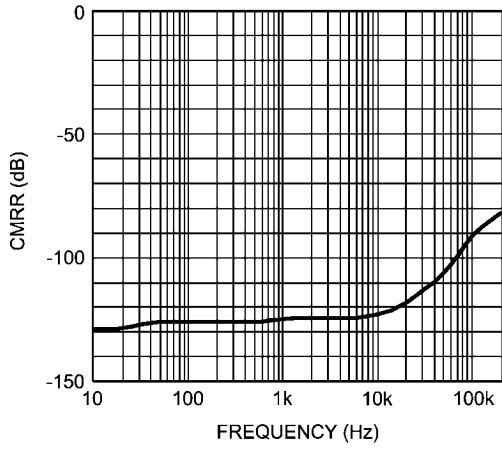

202104b3

**CMRR vs Frequency**  
 $V_{CC} = 12V, V_{EE} = -12V,$   
 $R_L = 600\Omega$

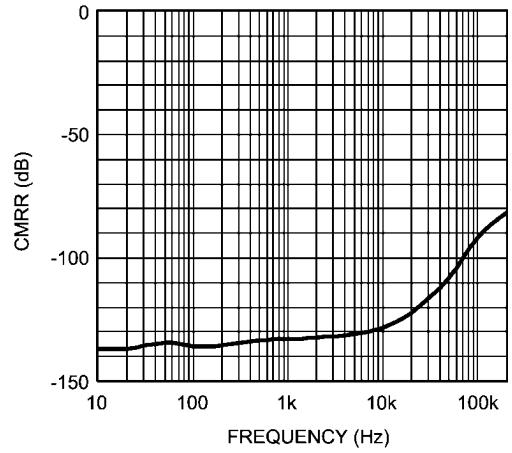

202104b0

**CMRR vs Frequency**  
 $V_{CC} = 17V, V_{EE} = -17V,$   
 $R_L = 600\Omega$

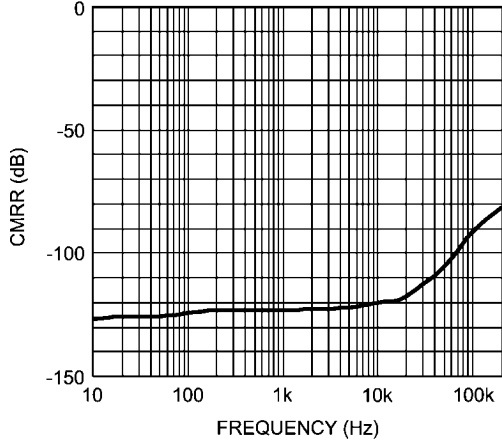

202104b6

**CMRR vs Frequency**  
 $V_{CC} = 2.5V, V_{EE} = -2.5V,$   
 $R_L = 600\Omega$

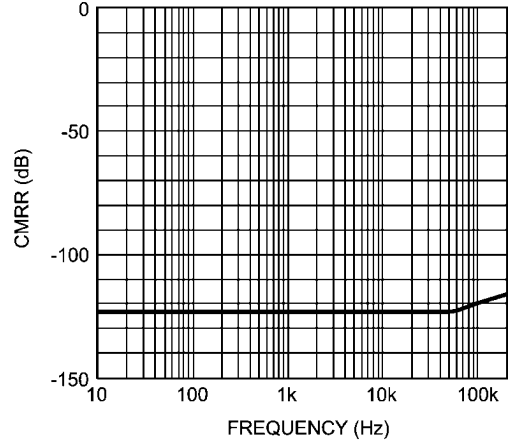

202104a7

**CMRR vs Frequency**  
 $V_{CC} = 15V, V_{EE} = -15V,$   
 $R_L = 10k\Omega$

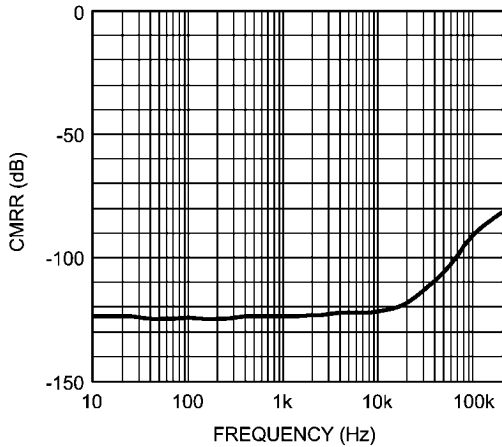

202104b2

**CMRR vs Frequency**  
 $V_{CC} = 12V, V_{EE} = -12V,$   
 $R_L = 10k\Omega$

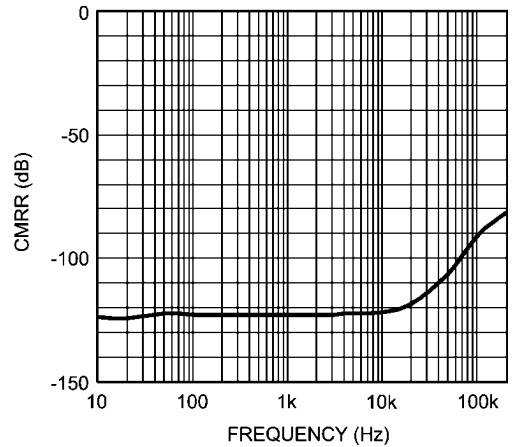

202104a9

**CMRR vs Frequency**  
 $V_{CC} = 17V, V_{EE} = -17V,$   
 $R_L = 10k\Omega$

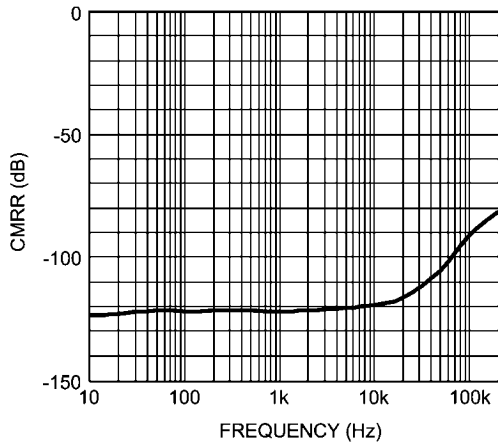

202104b5

**CMRR vs Frequency**  
 $V_{CC} = 2.5V, V_{EE} = -2.5V,$   
 $R_L = 10k\Omega$

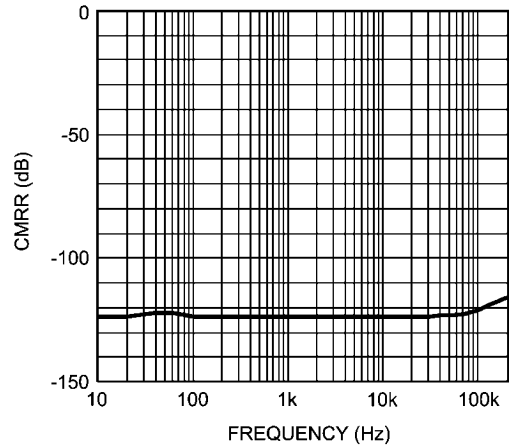

202104a6

**Output Voltage vs Supply Voltage**  
 $R_L = 2k\Omega, THD+N = 1\%$

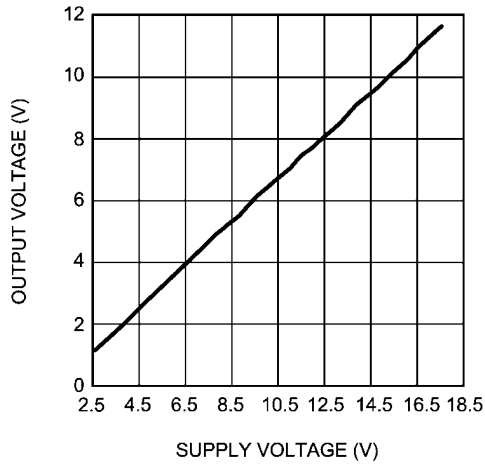

20210485

**Output Voltage vs Supply Voltage**  
 $R_L = 600\Omega, THD+N = 1\%$

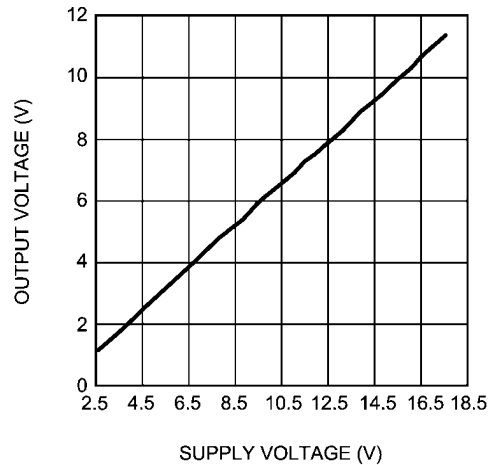

20210487

**Output Voltage vs Supply Voltage**  
 $R_L = 10k\Omega, THD+N = 1\%$

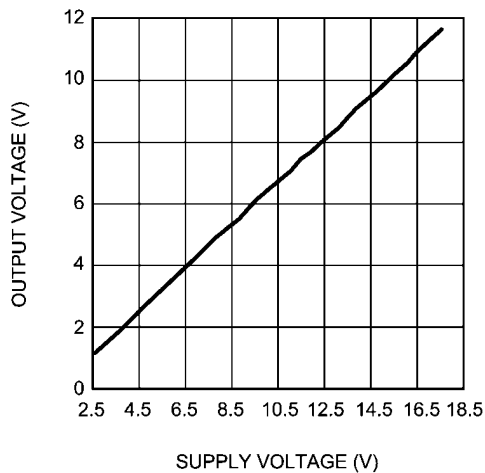

20210486

**Output Voltage vs Load Resistance**  
 $V_{CC} = 15V, V_{EE} = -15V, THD+N = 1\%$

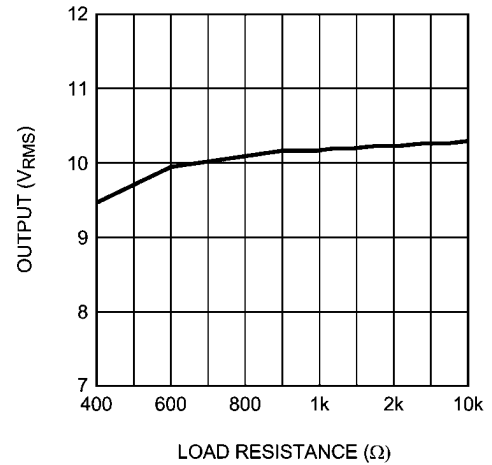

20210483

**Output Voltage vs Load Resistance**  
 $V_{CC} = 17V, V_{EE} = -17V, THD+N = 1\%$

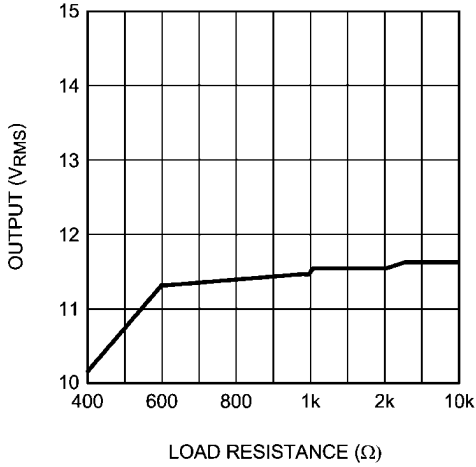

20210484

**Output Voltage vs Load Resistance**  
 $V_{CC} = 2.5V, V_{EE} = -2.5V, THD+N = 1\%$

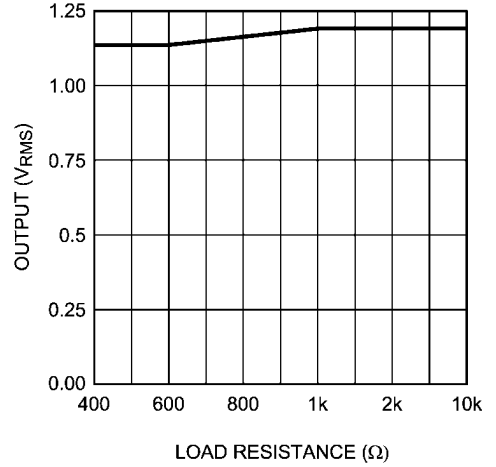

20210482

**Small-Signal Transient Response**  
 $A_V = -1, C_L = 100pF$

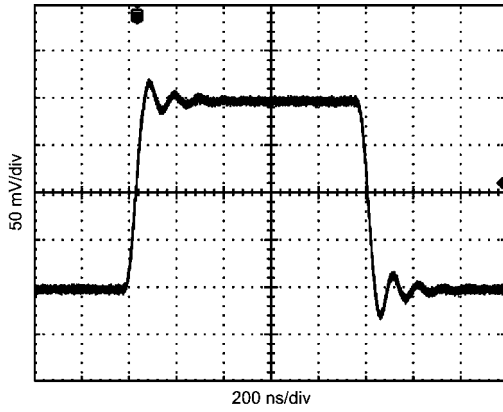

202104a4

**Large-Signal Transient Response**  
 $A_V = -1, C_L = 100pF$

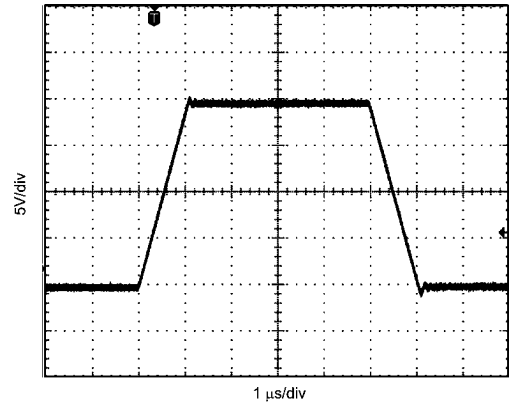

202104a3

## Application Hints

The LME49710 is a high speed op amp with excellent phase margin and stability. Capacitive loads up to 100pF will cause little change in the phase characteristics of the amplifiers and are therefore allowable.

Capacitive loads greater than 100pF must be isolated from the output. The most straight forward way to do this is to put a resistor in series with the output. This resistor will also prevent excess power dissipation if the output is accidentally shorted.

## Noise Measurement Circuit

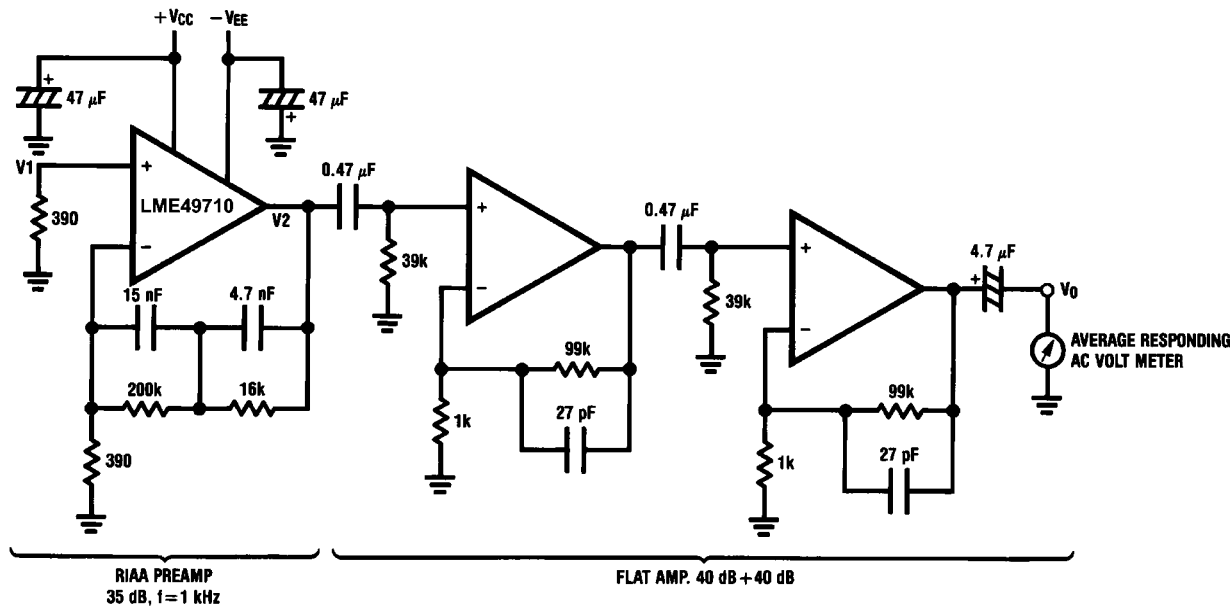

Complete shielding is required to prevent induced pick up from external sources. Always check with oscilloscope for power line noise.

20210427

**Total Gain: 115 dB at f = 1 kHz**  
**Input Referred Noise Voltage:  $e_n = V_o / 560,000$  (V)**

**RIAA Preamp Voltage Gain**  
**RIAA Deviation vs Frequency**  
 $V_{IN} = 10mV, A_V = 35.0dB, f = 1kHz$

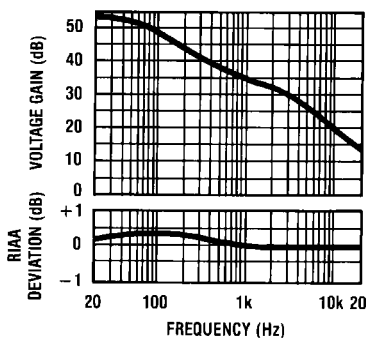

20210428

**Flat Amp Voltage Gain vs Frequency**  
 $V_o = 0dB, A_V = 80.0dB, f = 1kHz$

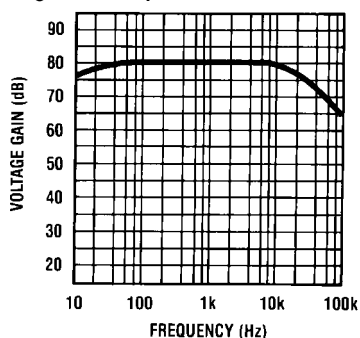

20210429

# Typical Applications

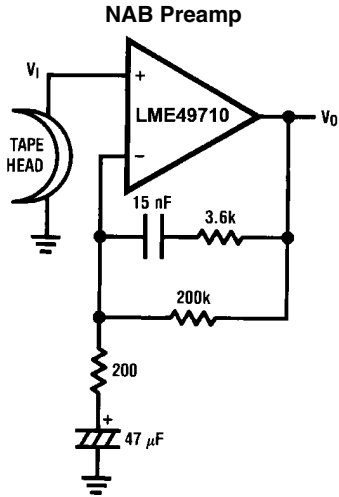

**NAB Preamp Voltage Gain vs Frequency**  
 $V_{IN} = 10\text{mV}$ , 34.5dB,  $f = 1\text{kHz}$

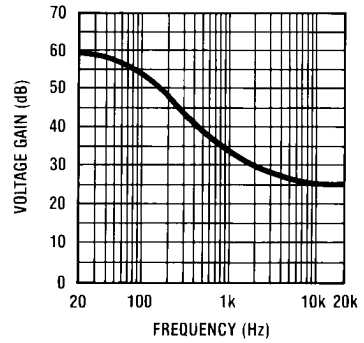

20210431

$A_V = 34.5$   
 $F = 1\text{ kHz}$   
 $E_n = 0.38\ \mu\text{V}$   
 A Weighted

20210430

**Balanced to Single Ended Converter**

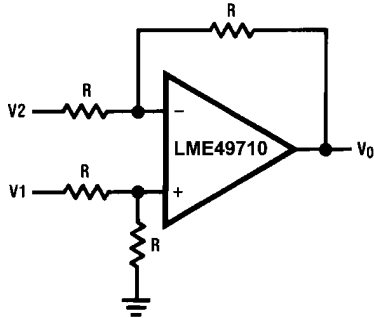

$V_O = V1 - V2$

20210432

**Adder/Subtractor**

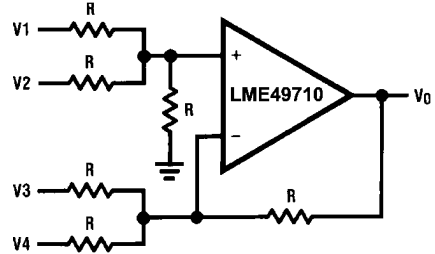

$V_O = V1 + V2 - V3 - V4$

20210433

**Sine Wave Oscillator**

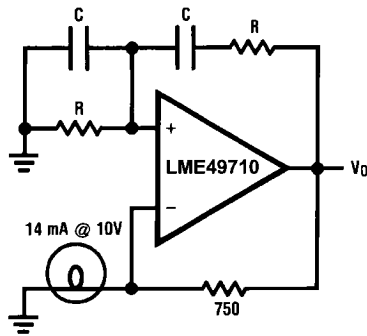

20210434

$f_o = \frac{1}{2\pi RC}$

**Second Order High Pass Filter (Butterworth)**

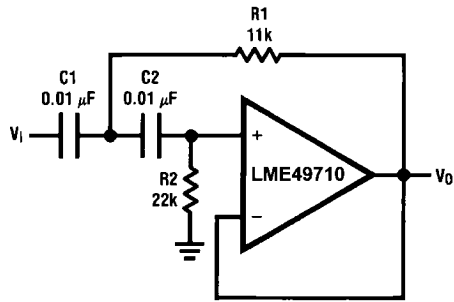

20210435

if  $C1 = C2 = C$

$$R1 = \frac{\sqrt{2}}{2\omega_0 C}$$

$$R2 = 2 \cdot R1$$

Illustration is  $f_0 = 1 \text{ kHz}$

**Second Order Low Pass Filter (Butterworth)**

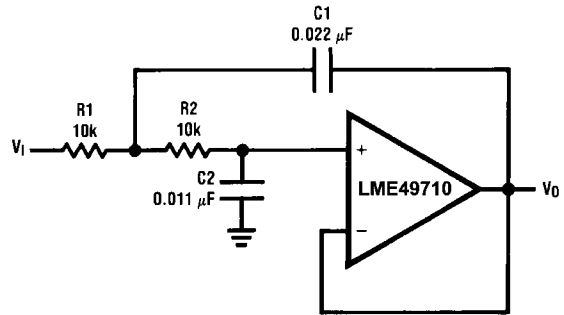

20210436

if  $R1 = R2 = R$

$$C1 = \frac{\sqrt{2}}{\omega_0 R}$$

$$C2 = \frac{C1}{2}$$

Illustration is  $f_0 = 1 \text{ kHz}$

**State Variable Filter**

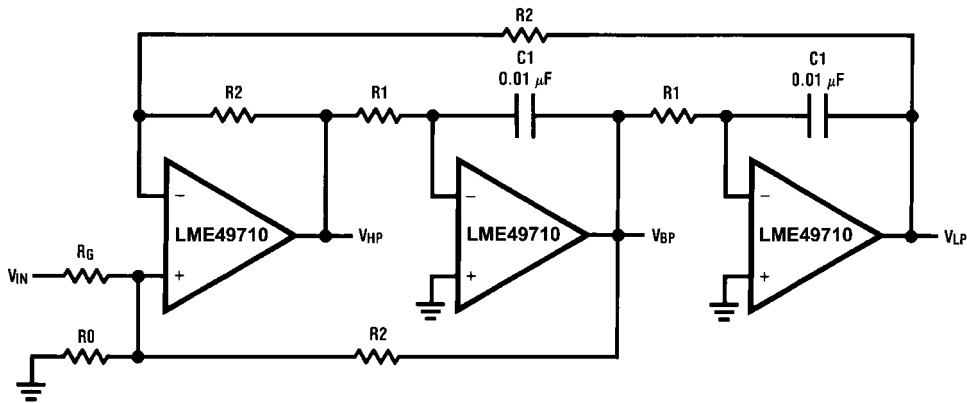

20210437

$$f_0 = \frac{1}{2\pi C1 R1}, Q = \frac{1}{2} \left( 1 + \frac{R2}{R0} + \frac{R2}{RG} \right), A_{BP} = Q A_{LP} = Q A_{LH} = \frac{R2}{RG}$$

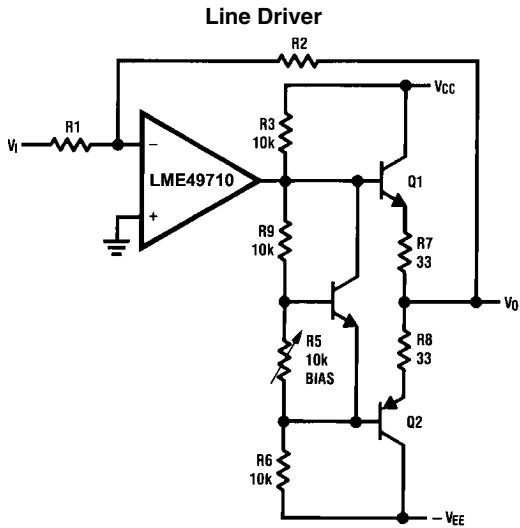

20210440

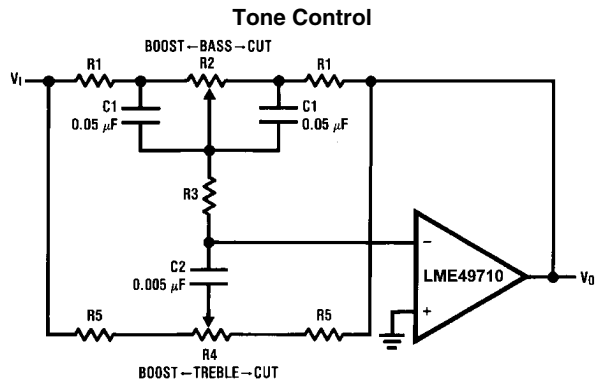

20210441

$$f_L = \frac{1}{2\pi R_2 C_1}, f_{LB} = \frac{1}{2\pi R_1 C_1}$$

$$f_H = \frac{1}{2\pi R_5 C_2}, f_{HB} = \frac{1}{2\pi(R_1 + R_5 + 2R_3)C_2}$$

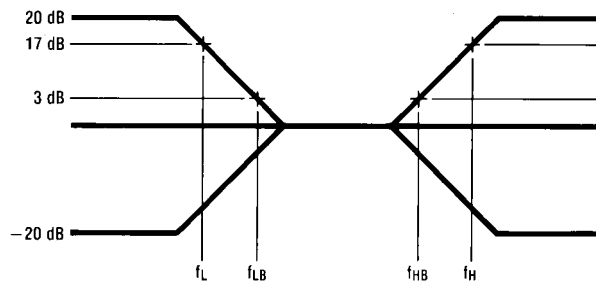

20210442

RIAA Preamp

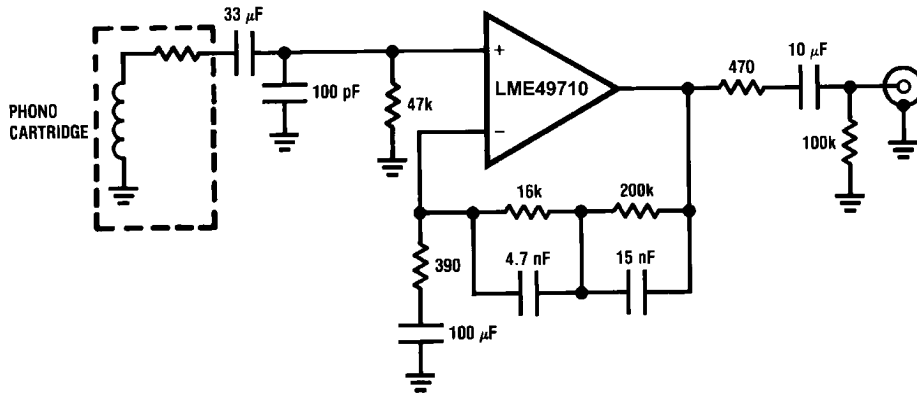

20210403

$A_v = 35 \text{ dB}$   
 $E_n = 0.33 \mu\text{V}$   
 $S/N = 90 \text{ dB}$   
 $f = 1 \text{ kHz}$   
 A Weighted  
 A Weighted,  $V_{IN} = 10 \text{ mV}$   
 @  $f = 1 \text{ kHz}$

Balanced Input Mic Amp

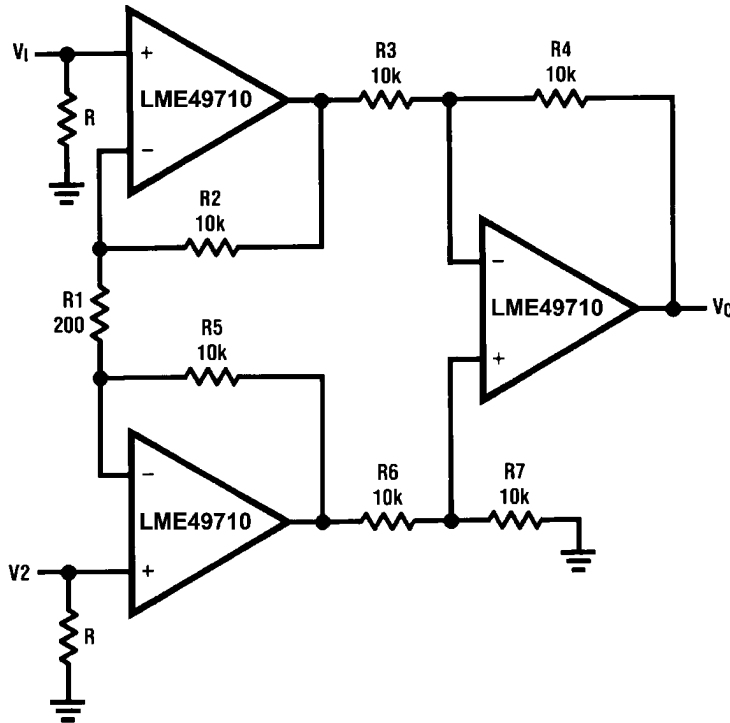

20210443

If  $R_2 = R_5, R_3 = R_6, R_4 = R_7$

$$V_0 = \left( 1 + \frac{2R_2}{R_1} \right) \frac{R_4}{R_3} (V_2 - V_1)$$

Illustration is:  
 $V_0 = 101(V_2 - V_1)$



## Application Information

### DISTORTION MEASUREMENTS

The vanishingly low residual distortion produced by LME49710 is below the capabilities of all commercially available equipment. This makes distortion measurements just slightly more difficult than simply connecting a distortion meter to the amplifier's inputs and outputs. The solution, however, is quite simple: an additional resistor. Adding this resistor extends the resolution of the distortion measurement equipment.

The LME49710's low residual distortion is an input referred internal error. As shown in Figure 2, adding the  $10\Omega$  resistor connected between the amplifier's inverting and non-inverting

inputs changes the amplifier's noise gain. The result is that the error signal (distortion) is amplified by a factor of 101. Although the amplifier's closed-loop gain is unaltered, the feedback available to correct distortion errors is reduced by 101, which means that measurement resolution increases by 101. To ensure minimum effects on distortion measurements, keep the value of R1 low as shown in Figure 2.

This technique is verified by duplicating the measurements with high closed loop gain and/or making the measurements at high frequencies. Doing so produces distortion components that are within the measurement equipment's capabilities. This datasheet's THD+N and IMD values were generated using the above described circuit connected to an Audio Precision System Two Cascade.

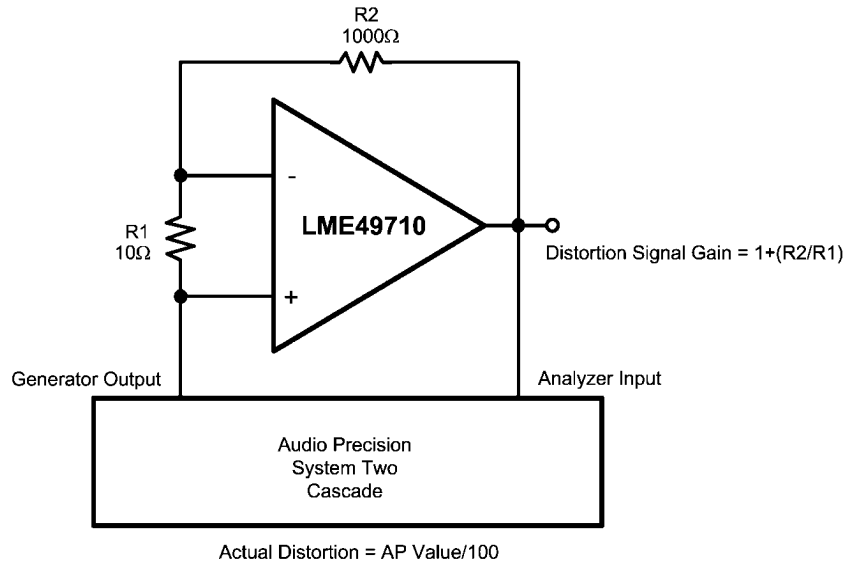

20210407

**FIGURE 2. THD+N and IMD Distortion Test Circuit**

## Revision History

Rev	Date	Description
1.0	11/16/07	Initial release.
1.1	12/12/06	Added the Typical Performance curves.
1.2	01/15/07	Added more curves and input some text edits.
1.3	03/09/07	Fixed graphics 20210489 and 90.

**Physical Dimensions** inches (millimeters) unless otherwise noted

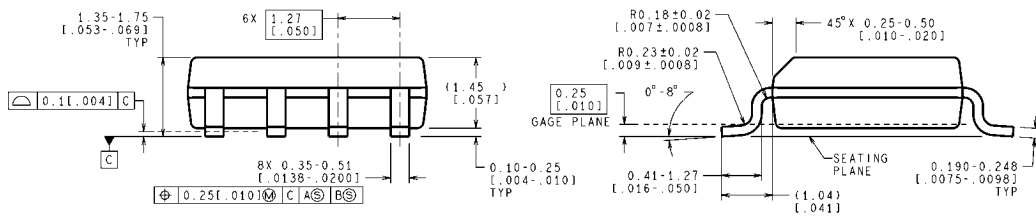
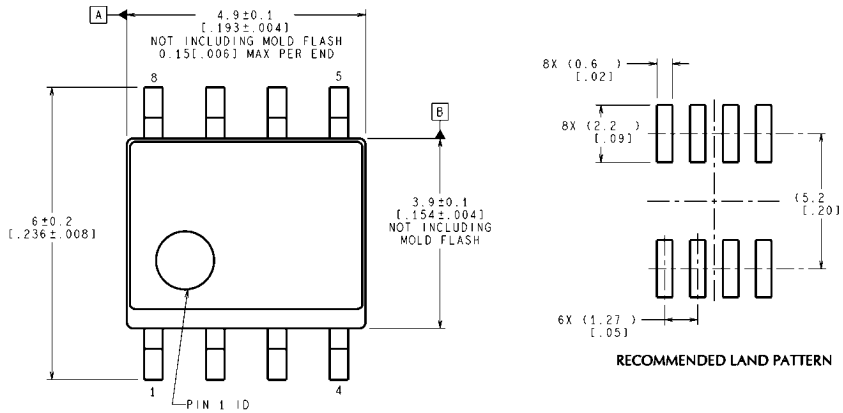

CONTROLLING DIMENSION IS MILLIMETER  
VALUES IN [ ] ARE INCHES  
DIMENSIONS IN ( ) FOR REFERENCE ONLY

M08A (Rev L)

**Dual-In-Line Package**  
**Order Number LME49710MA**  
**NS Package Number M08A**

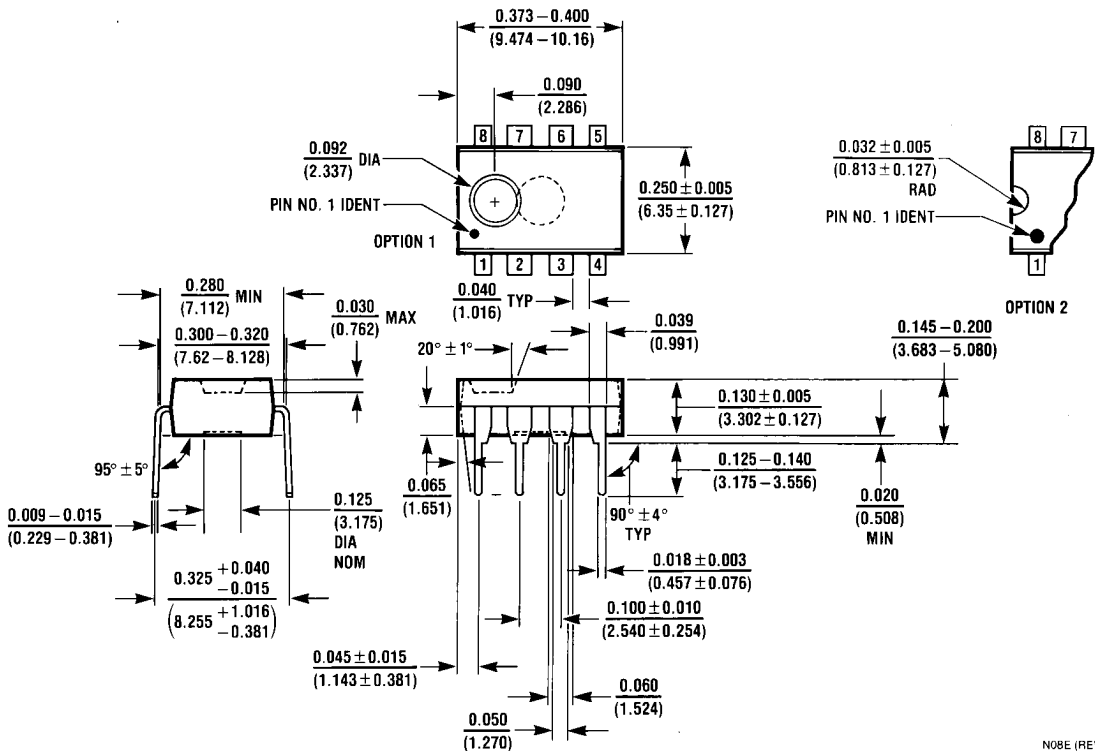

**Dual-In-Line Package**  
**Order Number LME49710NA**  
**NS Package Number N08E**

N08E (REV F)

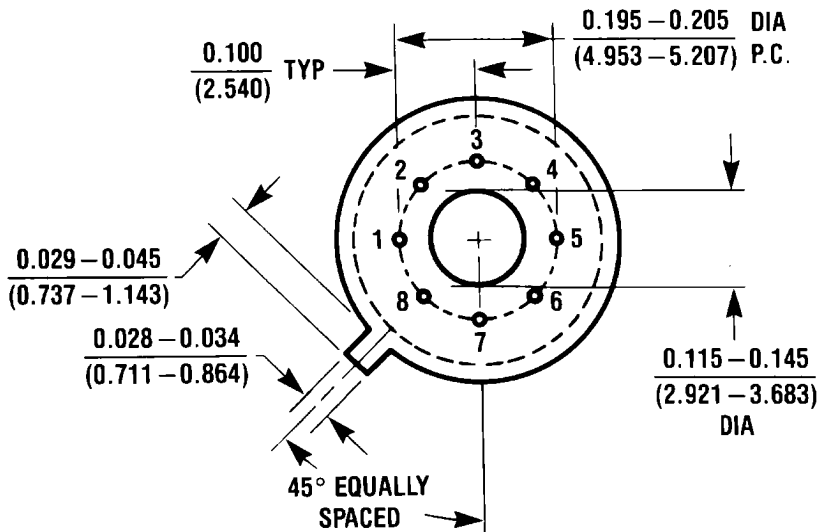
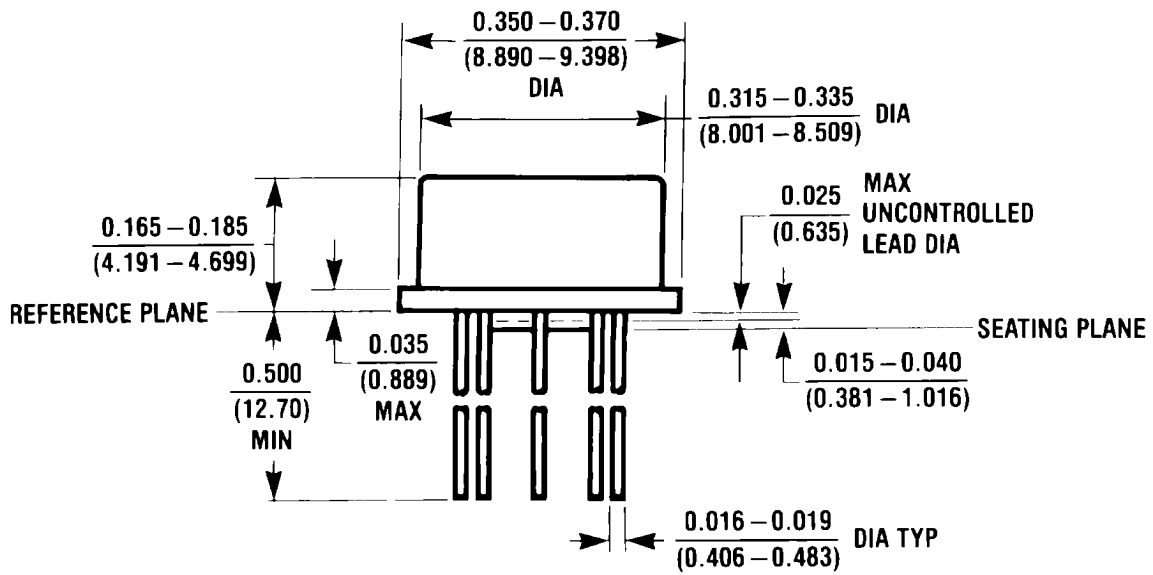

TO-99 Metal Can  
Order Number LME49710HA  
NS Package Number H08C

H08C (REV E)

## Notes

THE CONTENTS OF THIS DOCUMENT ARE PROVIDED IN CONNECTION WITH NATIONAL SEMICONDUCTOR CORPORATION ("NATIONAL") PRODUCTS. NATIONAL MAKES NO REPRESENTATIONS OR WARRANTIES WITH RESPECT TO THE ACCURACY OR COMPLETENESS OF THE CONTENTS OF THIS PUBLICATION AND RESERVES THE RIGHT TO MAKE CHANGES TO SPECIFICATIONS AND PRODUCT DESCRIPTIONS AT ANY TIME WITHOUT NOTICE. NO LICENSE, WHETHER EXPRESS, IMPLIED, ARISING BY ESTOPPEL OR OTHERWISE, TO ANY INTELLECTUAL PROPERTY RIGHTS IS GRANTED BY THIS DOCUMENT.

TESTING AND OTHER QUALITY CONTROLS ARE USED TO THE EXTENT NATIONAL DEEMS NECESSARY TO SUPPORT NATIONAL'S PRODUCT WARRANTY. EXCEPT WHERE MANDATED BY GOVERNMENT REQUIREMENTS, TESTING OF ALL PARAMETERS OF EACH PRODUCT IS NOT NECESSARILY PERFORMED. NATIONAL ASSUMES NO LIABILITY FOR APPLICATIONS ASSISTANCE OR BUYER PRODUCT DESIGN. BUYERS ARE RESPONSIBLE FOR THEIR PRODUCTS AND APPLICATIONS USING NATIONAL COMPONENTS. PRIOR TO USING OR DISTRIBUTING ANY PRODUCTS THAT INCLUDE NATIONAL COMPONENTS, BUYERS SHOULD PROVIDE ADEQUATE DESIGN, TESTING AND OPERATING SAFEGUARDS.

EXCEPT AS PROVIDED IN NATIONAL'S TERMS AND CONDITIONS OF SALE FOR SUCH PRODUCTS, NATIONAL ASSUMES NO LIABILITY WHATSOEVER, AND NATIONAL DISCLAIMS ANY EXPRESS OR IMPLIED WARRANTY RELATING TO THE SALE AND/OR USE OF NATIONAL PRODUCTS INCLUDING LIABILITY OR WARRANTIES RELATING TO FITNESS FOR A PARTICULAR PURPOSE, MERCHANTABILITY, OR INFRINGEMENT OF ANY PATENT, COPYRIGHT OR OTHER INTELLECTUAL PROPERTY RIGHT.

### LIFE SUPPORT POLICY

**NATIONAL'S PRODUCTS ARE NOT AUTHORIZED FOR USE AS CRITICAL COMPONENTS IN LIFE SUPPORT DEVICES OR SYSTEMS WITHOUT THE EXPRESS PRIOR WRITTEN APPROVAL OF THE CHIEF EXECUTIVE OFFICER AND GENERAL COUNSEL OF NATIONAL SEMICONDUCTOR CORPORATION.** As used herein:

Life support devices or systems are devices which (a) are intended for surgical implant into the body, or (b) support or sustain life and whose failure to perform when properly used in accordance with instructions for use provided in the labeling can be reasonably expected to result in a significant injury to the user. A critical component is any component in a life support device or system whose failure to perform can be reasonably expected to cause the failure of the life support device or system or to affect its safety or effectiveness.

National Semiconductor and the National Semiconductor logo are registered trademarks of National Semiconductor Corporation. All other brand or product names may be trademarks or registered trademarks of their respective holders.

Copyright© 2007 National Semiconductor Corporation

For the most current product information visit us at [www.national.com](http://www.national.com)



**National Semiconductor  
Americas Customer  
Support Center**  
Email:  
[new.feedback@nsc.com](mailto:new.feedback@nsc.com)  
Tel: 1-800-272-9959

**National Semiconductor Europe  
Customer Support Center**  
Fax: +49 (0) 180-530-85-86  
Email: [europe.support@nsc.com](mailto:europe.support@nsc.com)  
Deutsch Tel: +49 (0) 69 9508 6208  
English Tel: +49 (0) 870 24 0 2171  
Français Tel: +33 (0) 1 41 91 8790

**National Semiconductor Asia  
Pacific Customer Support Center**  
Email: [ap.support@nsc.com](mailto:ap.support@nsc.com)

**National Semiconductor Japan  
Customer Support Center**  
Fax: 81-3-5639-7507  
Email: [jpn.feedback@nsc.com](mailto:jpn.feedback@nsc.com)  
Tel: 81-3-5639-7560

## IMPORTANT NOTICE

Texas Instruments Incorporated and its subsidiaries (TI) reserve the right to make corrections, modifications, enhancements, improvements, and other changes to its products and services at any time and to discontinue any product or service without notice. Customers should obtain the latest relevant information before placing orders and should verify that such information is current and complete. All products are sold subject to TI's terms and conditions of sale supplied at the time of order acknowledgment.

TI warrants performance of its hardware products to the specifications applicable at the time of sale in accordance with TI's standard warranty. Testing and other quality control techniques are used to the extent TI deems necessary to support this warranty. Except where mandated by government requirements, testing of all parameters of each product is not necessarily performed.

TI assumes no liability for applications assistance or customer product design. Customers are responsible for their products and applications using TI components. To minimize the risks associated with customer products and applications, customers should provide adequate design and operating safeguards.

TI does not warrant or represent that any license, either express or implied, is granted under any TI patent right, copyright, mask work right, or other TI intellectual property right relating to any combination, machine, or process in which TI products or services are used. Information published by TI regarding third-party products or services does not constitute a license from TI to use such products or services or a warranty or endorsement thereof. Use of such information may require a license from a third party under the patents or other intellectual property of the third party, or a license from TI under the patents or other intellectual property of TI.

Reproduction of TI information in TI data books or data sheets is permissible only if reproduction is without alteration and is accompanied by all associated warranties, conditions, limitations, and notices. Reproduction of this information with alteration is an unfair and deceptive business practice. TI is not responsible or liable for such altered documentation. Information of third parties may be subject to additional restrictions.

Resale of TI products or services with statements different from or beyond the parameters stated by TI for that product or service voids all express and any implied warranties for the associated TI product or service and is an unfair and deceptive business practice. TI is not responsible or liable for any such statements.

TI products are not authorized for use in safety-critical applications (such as life support) where a failure of the TI product would reasonably be expected to cause severe personal injury or death, unless officers of the parties have executed an agreement specifically governing such use. Buyers represent that they have all necessary expertise in the safety and regulatory ramifications of their applications, and acknowledge and agree that they are solely responsible for all legal, regulatory and safety-related requirements concerning their products and any use of TI products in such safety-critical applications, notwithstanding any applications-related information or support that may be provided by TI. Further, Buyers must fully indemnify TI and its representatives against any damages arising out of the use of TI products in such safety-critical applications.

TI products are neither designed nor intended for use in military/aerospace applications or environments unless the TI products are specifically designated by TI as military-grade or "enhanced plastic." Only products designated by TI as military-grade meet military specifications. Buyers acknowledge and agree that any such use of TI products which TI has not designated as military-grade is solely at the Buyer's risk, and that they are solely responsible for compliance with all legal and regulatory requirements in connection with such use.

TI products are neither designed nor intended for use in automotive applications or environments unless the specific TI products are designated by TI as compliant with ISO/TS 16949 requirements. Buyers acknowledge and agree that, if they use any non-designated products in automotive applications, TI will not be responsible for any failure to meet such requirements.

Following are URLs where you can obtain information on other Texas Instruments products and application solutions:

### Products

Audio	<a href="http://www.ti.com/audio">www.ti.com/audio</a>
Amplifiers	<a href="http://amplifier.ti.com">amplifier.ti.com</a>
Data Converters	<a href="http://dataconverter.ti.com">dataconverter.ti.com</a>
DLP® Products	<a href="http://www.dlp.com">www.dlp.com</a>
DSP	<a href="http://dsp.ti.com">dsp.ti.com</a>
Clocks and Timers	<a href="http://www.ti.com/clocks">www.ti.com/clocks</a>
Interface	<a href="http://interface.ti.com">interface.ti.com</a>
Logic	<a href="http://logic.ti.com">logic.ti.com</a>
Power Mgmt	<a href="http://power.ti.com">power.ti.com</a>
Microcontrollers	<a href="http://microcontroller.ti.com">microcontroller.ti.com</a>
RFID	<a href="http://www.ti-rfid.com">www.ti-rfid.com</a>
OMAP Mobile Processors	<a href="http://www.ti.com/omap">www.ti.com/omap</a>
Wireless Connectivity	<a href="http://www.ti.com/wirelessconnectivity">www.ti.com/wirelessconnectivity</a>

### Applications

Communications and Telecom	<a href="http://www.ti.com/communications">www.ti.com/communications</a>
Computers and Peripherals	<a href="http://www.ti.com/computers">www.ti.com/computers</a>
Consumer Electronics	<a href="http://www.ti.com/consumer-apps">www.ti.com/consumer-apps</a>
Energy and Lighting	<a href="http://www.ti.com/energy">www.ti.com/energy</a>
Industrial	<a href="http://www.ti.com/industrial">www.ti.com/industrial</a>
Medical	<a href="http://www.ti.com/medical">www.ti.com/medical</a>
Security	<a href="http://www.ti.com/security">www.ti.com/security</a>
Space, Avionics and Defense	<a href="http://www.ti.com/space-avionics-defense">www.ti.com/space-avionics-defense</a>
Transportation and Automotive	<a href="http://www.ti.com/automotive">www.ti.com/automotive</a>
Video and Imaging	<a href="http://www.ti.com/video">www.ti.com/video</a>

TI E2E Community Home Page

[e2e.ti.com](http://e2e.ti.com)

Mailing Address: Texas Instruments, Post Office Box 655303, Dallas, Texas 75265  
Copyright © 2011, Texas Instruments Incorporated